



NONRESIDENT TRAINING COURSE



June 1998

Illustrator Draftsman 3 & 2

Volume 3—Executionable Practices

NAVEDTRA 14262

NOTICE

Pages 2-4, 2-9, 2-10, 2-11, 2-12, 2-13, 2-14, 2-15, 2-16, 2-18, 2-19, 2-20, 2-21, 2-22, 2-23, 2-24, 2-25, 2-27, 2-28, 2-30, 2-33 must be printed on a **COLOR** printer.

Although the words “he,” “him,” and “his” are used sparingly in this course to enhance communication, they are not intended to be gender driven or to affront or discriminate against anyone.

PREFACE

By enrolling in this self-study course, you have demonstrated a desire to improve yourself and the Navy. Remember, however, this self-study course is only one part of the total Navy training program. Practical experience, schools, selected reading, and your desire to succeed are also necessary to successfully round out a fully meaningful training program.

COURSE OVERVIEW: In completing this nonresident training course, you will demonstrate a knowledge of the subject matter by correctly answering questions on the following subjects: the theory of color, photography, computer-generated art, figure drawing, cartooning, animation, mediums, lettering, and airbrush.

THE COURSE: This self-study course is organized into subject matter areas, each containing learning objectives to help you determine what you should learn along with text and illustrations to help you understand the information. The subject matter reflects day-to-day requirements and experiences of personnel in the rating or skill area. It also reflects guidance provided by Enlisted Community Managers (ECMs) and other senior personnel, technical references, instructions, etc., and either the occupational or naval standards, which are listed in the *Manual of Navy Enlisted Manpower Personnel Classifications and Occupational Standards*, NAVPERS 18068.

THE QUESTIONS: The questions that appear in this course are designed to help you understand the material in the text.

VALUE: In completing this course, you will improve your military and professional knowledge. Importantly, it can also help you study for the Navy-wide advancement in rate examination. If you are studying and discover a reference in the text to another publication for further information, look it up.

*1998 Edition Prepared by
DMCS(SW) Sandra M. Bryan*

Published by
NAVAL EDUCATION AND TRAINING
PROFESSIONAL DEVELOPMENT
AND TECHNOLOGY CENTER

**NAVSUP Logistics Tracking Number
0504-LP-026-8940**

Sailor's Creed

“I am a United States Sailor.

I will support and defend the Constitution of the United States of America and I will obey the orders of those appointed over me.

I represent the fighting spirit of the Navy and those who have gone before me to defend freedom and democracy around the world.

I proudly serve my country's Navy combat team with honor, courage and commitment.

I am committed to excellence and the fair treatment of all.”

CONTENTS

| | | |
|-----------------|--------------------------------------|-----|
| Chapters | 1. Mediums. | 1-1 |
| | 2. Color | 2-1 |
| | 3. Drawing | 3-1 |
| | 4. Cartooning and Animation. | 4-1 |
| | 5. Lettering. | 5-1 |
| | 6. Airbrush. | 6-1 |
| | 7. Photography. | 7-1 |
| | 8. Computer Generation. | 8-1 |

| | | |
|-------------------|--|-------|
| Appendices | I. Glossary. | AI-1 |
| | II. References Used to Develop This TRAMAN | AII-1 |

| | | |
|--------------|----------------|---------|
| Index | INDEX. | INDEX-1 |
|--------------|----------------|---------|

ILLUSTRATOR DRAFTSMAN (DM) TRAINING SERIES

The following volumes in the DM Training Series are available or planned:

**DM, Vol. 1,
NAVEDTRA
12720**

Equipment. This is an overview of general shop administration, available equipment, required operator adjustments, and equipment maintenance. Knowing the capabilities and limitations of the equipment before creating artwork is essential.

**DM, Vol. 2,
NAVEDTRA
12721**

Standard Drafting Practices And Theory. Industry standards for technical drawing, geometric construction, general drafting practices, parallel projections, perspective, and composition are foundational material on which all executable practices rely.

**DM, Vol. 3,
NAVEDTRA
12722**

Executionable Practices. These chapters cover the theory of color, photography, computer-generated art, figure drawing, cartooning, animation, mediums, lettering, and airbrush. These are the skills a successful DM must master.

**DM, Vol. 4,
NAVEDTRA
12723**

Presentations Graphics. Pre-press copy preparation, television graphics, displays, exhibits, and audiovisual presentations are end products and will influence how and why DMs work with certain media.

**Nonresident
Training
Courses
(NRTC)**

Nonresident Training Courses for the Illustrator Draftsman (DM) TRAMAN:

| Paygrade | Volume | NRTC |
|----------|----------|----------------|
| E4/E5 | Volume 1 | NAVEDTRA 72720 |
| | Volume 2 | NAVEDTRA 72721 |
| | Volume 3 | NAVEDTRA 72722 |
| | Volume 4 | NAVEDTRA 12723 |
| E6/E7 | Volume 1 | NAVEDTRA 82720 |
| | Volume 3 | NAVEDTRA 82722 |
| | Volume 4 | NAVEDTRA 12723 |

NOTE:

Check the Naval Education and Training Professional Development and Technology Center home page for advancement requirements (<http://www.cnet.navy.mil/netpdtc/netpdtc.htm>.) and the *Catalog of Nonresident Training Courses*, NAVEDTRA 12061, for ordering information.

INSTRUCTIONS FOR TAKING THE COURSE

ASSIGNMENTS

The text pages that you are to study are listed at the beginning of each assignment. Study these pages carefully before attempting to answer the questions. Pay close attention to tables and illustrations and read the learning objectives. The learning objectives state what you should be able to do after studying the material. Answering the questions correctly helps you accomplish the objectives.

SELECTING YOUR ANSWERS

Read each question carefully, then select the BEST answer. You may refer freely to the text. The answers must be the result of your own work and decisions. You are prohibited from referring to or copying the answers of others and from giving answers to anyone else taking the course.

SUBMITTING YOUR ASSIGNMENTS

To have your assignments graded, you must be enrolled in the course with the Nonresident Training Course Administration Branch at the Naval Education and Training Professional Development and Technology Center (NETPDTC). Following enrollment, there are two ways of having your assignments graded: (1) use the Internet to submit your assignments as you complete them, or (2) send all the assignments at one time by mail to NETPDTC.

Grading on the Internet: Advantages to Internet grading are:

- you may submit your answers as soon as you complete an assignment, and
- you get your results faster; usually by the next working day (approximately 24 hours).

In addition to receiving grade results for each assignment, you will receive course completion confirmation once you have completed all the

assignments. To submit your assignment answers via the Internet, go to:

<http://courses.cnet.navy.mil>

Grading by Mail: When you submit answer sheets by mail, send all of your assignments at one time. Do NOT submit individual answer sheets for grading. Mail all of your assignments in an envelope, which you either provide yourself or obtain from your nearest Educational Services Officer (ESO). Submit answer sheets to:

COMMANDING OFFICER
NETPDTC N331
6490 SAUFLEY FIELD ROAD
PENSACOLA FL 32559-5000

Answer Sheets: All courses include one “scannable” answer sheet for each assignment. These answer sheets are preprinted with your SSN, name, assignment number, and course number. Explanations for completing the answer sheets are on the answer sheet.

Do not use answer sheet reproductions: Use only the original answer sheets that we provide—reproductions will not work with our scanning equipment and cannot be processed.

Follow the instructions for marking your answers on the answer sheet. Be sure that blocks 1, 2, and 3 are filled in correctly. This information is necessary for your course to be properly processed and for you to receive credit for your work.

COMPLETION TIME

Courses must be completed within 12 months from the date of enrollment. This includes time required to resubmit failed assignments.

PASS/FAIL ASSIGNMENT PROCEDURES

If your overall course score is 3.2 or higher, you will pass the course and will not be required to resubmit assignments. Once your assignments have been graded you will receive course completion confirmation.

If you receive less than a 3.2 on any assignment and your overall course score is below 3.2, you will be given the opportunity to resubmit failed assignments. **You may resubmit failed assignments only once.** Internet students will receive notification when they have failed an assignment--they may then resubmit failed assignments on the web site. Internet students may view and print results for failed assignments from the web site. Students who submit by mail will receive a failing result letter and a new answer sheet for resubmission of each failed assignment.

COMPLETION CONFIRMATION

After successfully completing this course, you will receive a letter of completion.

ERRATA

Errata are used to correct minor errors or delete obsolete information in a course. Errata may also be used to provide instructions to the student. If a course has an errata, it will be included as the first page(s) after the front cover. Errata for all courses can be accessed and viewed/downloaded at:

<http://www.advancement.cnet.navy.mil>

STUDENT FEEDBACK QUESTIONS

We value your suggestions, questions, and criticisms on our courses. If you would like to communicate with us regarding this course, we encourage you, if possible, to use e-mail. If you write or fax, please use a copy of the Student Comment form that follows this page.

For subject matter questions:

E-mail: n313.products@cnet.navy.mil
Phone: Comm: (850) 452-1001, Ext. 2167
DSN: 922-1001, Ext. 2167
FAX: (850) 452-1370
(Do not fax answer sheets.)
Address: COMMANDING OFFICER
NETPDTC N313
6490 SAUFLEY FIELD ROAD
PENSACOLA FL 32509-5237

For enrollment, shipping, grading, or completion letter questions

E-mail: fleetservices@cnet.navy.mil
Phone: Toll Free: 877-264-8583
Comm: (850) 452-1511/1181/1859
DSN: 922-1511/1181/1859
FAX: (850) 452-1370
(Do not fax answer sheets.)
Address: COMMANDING OFFICER
NETPDTC N331
6490 SAUFLEY FIELD ROAD
PENSACOLA FL 32559-5000

NAVAL RESERVE RETIREMENT CREDIT

If you are a member of the Naval Reserve, you may earn retirement points for successfully completing this course, if authorized under current directives governing retirement of Naval Reserve personnel. For Naval Reserve retirement, this course is evaluated at 12 points. (Refer to *Administrative Procedures for Naval Reservists on Inactive Duty*, BUPERSINST 1001.39, for more information about retirement points.)

Student Comments

Course Title: Illustrator Draftsman 3 & 2, Volume 3—Executionable Practices

NAVEDTRA: 14262 **Date:** _____

We need some information about you:

Rate/Rank and Name: _____ SSN: _____ Command/Unit _____

Street Address: _____ City: _____ State/FPO: _____ Zip _____

Your comments, suggestions, etc.:

| |
|--|
| <p>Privacy Act Statement: Under authority of Title 5, USC 301, information regarding your military status is requested in processing your comments and in preparing a reply. This information will not be divulged without written authorization to anyone other than those within DOD for official use in determining performance.</p> |
|--|

NETPDTC 1550/41 (Rev 4-00)

CHAPTER 1

MEDIUMS

Overview

Introduction

Mastering the basic mediums of pencil, pen and ink, charcoal, pastel, and pigments is still the prerequisite for success as an Illustrator Draftsman. Indeed, for many, the appeal of the DM rating has everything to do with the tactile element of the more traditional media. Even if you work primarily with computer-generated imagery, you are expected to know the visual impression given by different media over various surfaces, blending techniques, and reproduction and presentation limitations.

Objectives

The material in this chapter enables you to do the following:

- Differentiate between continuous-tone pen and ink drawings and line rendering.
 - Select a medium based on the intended creative statement.
 - Select a paper appropriate to the desired media.
 - Recognize the versatility of various media.
 - Distinguish between oil-based, water-based, and polymer-based pigments.
-

Continued on next page

Overview, Continued

Acronyms

The following table contains a list of acronyms that you must know to understand the material in this chapter.

| Acronym | Meaning |
|----------------|------------------------|
| B | Lead Softness |
| CP | Cold Pressed |
| H | Lead Hardness |
| HP | Hot Pressed |
| PSI | Pounds-per-Square Inch |

Continued on next page

Overview, Continued

In this chapter This chapter covers the following topics:

| Topic | See Page |
|------------------------|-----------------|
| Papers | 1-4 |
| Erasers | 1-8 |
| Pencils | 1-12 |
| Brushes | 1-25 |
| Pens and Inks | 1-31 |
| Pastels and Charcoals | 1-44 |
| Oil-Based Pigments | 1-48 |
| Acrylic-Based Pigments | 1-53 |
| Water-Based Pigments | 1-56 |

Papers

Introduction

The paper you select for your artwork is important. Give the process of selecting a paper as much thought as you do the subject matter, media selection, and reproduction process. There are too many types of paper available to discuss each in detail, but there are some common features and general truths. To develop comprehensive knowledge on paper make-up and surfaces, contact a manufacturer. Paper companies are generous with paper samples, and swatches upon request.

Paper products

In general, paper products are made from the pulp of trees. Fiber is ground into pulp and chemicals and synthetics are added that affect the strength and durability of the final sheet of paper. These acidic chemicals cause deterioration and discoloration, a process called foxing. A deteriorating paper accelerates the breakdown of other papers in contact with it. High quality papers contain rag or cotton fibers. The three categories of paper are rag paper, a combination of wood pulp and rag, and wood pulp papers. If you are looking for permanence in a mat board or illustration board, select a paper with a neutral-ph rate or archival quality high rag content. Archival quality papers cost more but the acidity of the chemicals is neutralized or removed.

Paper quality

Use quality paper for your artwork. Quality refers to the paper surface, rated durability, and the ability of the paper to perform or accept particular media. Quality papers are stamped or pressed with a watermark indicating rag content. A watermark is a mark made by manufacturers to identify a line of their product. A watermark is visible only when you hold the paper against light.

Paper weight

The weight of paper usually, but not always, refers to thickness. The thickness of paper is determined by how much a ream (500 sheets) of that size paper weighs. For example, 300-pound watercolor paper means that 500 sheets of that paper weighs 300 pounds total. A sheet of 200-pound watercolor paper of the same size (dimensions) would be a thinner sheet of paper, and therefore would weigh less.

Continued on next page

Papers, Continued

Paper size Paper is manufactured in industry standard sizes. Countries that use the metric system of measurement have different standards than the United States. If you buy paper outside the government supply system in a foreign country, make sure you understand its unit of measure before you order.

Paper surfaces Paper surfaces range from slick to rough. Some papers have a right and wrong side or two different surface textures. An excellent paper surface contributes to the professional appearance of an end product. Paper receives a surface as it passes through manufacturer's surfacing rollers when the paper is either cold or hot. Hence, the terms cold-pressed (CP) and hot-pressed (HP).

HOT-PRESSED PAPER: Hot-pressed paper has a smooth surface. Also called plate-finish or high-surfaced, this is the family of paper you should select to do tight renderings in pen and ink, most calligraphy, and art intended for reproduction. Hot-pressed paper is not a good choice for pencil, pastels, or any media that requires roughness to deposit pigment. Hot-pressed paper is less absorbent and more dense than CP paper.

COLD-PRESSED PAPER: Cold-pressed paper has a medium to rough surface. The roughness of the surface is called tooth. Papers with tooth will break up most strokes. The rougher surfaced papers such as coquille board break strokes up enough to have the resulting art photographed as line drawings. Papers with rough surfaces do not reproduce halftones well. Cold-pressed paper can present lighting problems when you use them for art intended for photographic reproduction. Most general drawing and practice pads and newsprint are made from cold-pressed paper. CP paper is more absorbent, therefore, more affected by humidity than HP paper.

Humidity Paper is affected by humidity and dryness. Paper surfaces absorb moisture from the air making the surface soft and easily scarred. The paper will be limp and tend to wrinkle and curl. Heavy-handed pressure on paper during a humid day scores or gouges the paper surface. Dry air dries paper out. It becomes brittle and creases easily.

Continued on next page

Papers, Continued

Paper types

Before you select a paper, choose the media. Papers suitable for one media are not suitable for another. Briefly, here is a general list of papers you will find in Navy graphics shops and their intended uses.

STENCIL BOARD: A cheap, low quality, oil-soaked board intended for use as a stencil and thrown away. Stencil board is oil soaked to resist saturation from both oil- and water-based pigments and strong enough to withstand rough handling. Stencil board is not suitable for illustrations or paintings and over time will stain any other item it touches.

GOLDENROD: Goldenrod provides rigid support for negatives stripped together as a page before exposure as a printing plate. Goldenrod is golden orange in color and has a grid. Paper size corresponds with plate dimensions of the printing presses.

SARAL PAPER or CARBON PAPER: Saral paper is an image transfer paper available in various pastel hues. Carbon paper is an image transfer paper available in blue or black. These papers are similar in their ability to transfer images; however, saral paper erases easier than carbon paper.

SCRATCHBOARD: Scratchboard is a hot-pressed illustration board with a gesso-coated (chalk) surface covered by a dense black pigment. You draw on it by using a set of scratching knives to produce a white line on a black background. The resulting art resembles a woodcut or linoleum engraving.

TRACING PAPER (VELLUM): Rag content (cotton fiber) determines the quality of tracing paper or vellum. Tracing paper and vellum may be transparent or translucent, bright white or dull blue, and plain or gridded. Tracing paper takes ink and pencil well; however, large areas of opaque ink will curl the paper when the ink dries. The primary purpose of tracing or vellum is in technical drawing, drafting, and viewgraph production using diazo processes.

COATED STOCK: Paper or illustration board has a smooth and glossy coated surface. Coated stock is ideal for fine ink drawings and illustrations where a smooth surface is desirable.

Continued on next page

Papers, Continued

Paper types (Continued)

CANVAS BOARD: Canvas board is thick illustration board covered with light canvas and sized with gesso to accept oil and acrylic paints. This board performs in every way like canvas.

NEWSPRINT: Newsprint paper is a cheap, high pulp content paper ideal for drawing and sketching. Newsprint discolors rapidly and crumbles as it ages. Do not choose newsprint for permanent or file drawings and master art. Newsprint is ideal for thumbnail sketches or warm-up exercises before you begin drawing.

PASTEL PAPER: Papers for pastel drawings have a coating of marble dust or pumice to trap pigment. Select surface textures according to your preference. Very fine pastel papers are called velour canvas. Most pastelists prefer a pastel colored pastel paper over white to unify the pastel drawing and intensify the pastel colored pigment.

CHARCOAL PAPER: Charcoal paper is a toothy paper with high absorbance used for drawings made with charcoal or dry pastels. Charcoal clings to the paper and smears less than on smoother paper.

WATERCOLOR PAPER: Paper used for watercolor painting has greater absorbance than papers made for illustration. Choose watercolor paper carefully. Surface texture shows through a true (transparent) watercolor medium. Select a paper that is 100% rag and white. The three general surfaces available in watercolor paper are rough, medium (CP), and smooth (HP). Different weights are available to suit your preference.

ILLUSTRATION BOARD: Illustration board is a stiff board with a portion of rag content that increases with the rated quality of board. The surface texture of illustration board varies. Illustration board is suitable for all media and medium or high quality boards offer some degree of permanence.

MAT BOARD: Mat board is used to surround images with complimentary borders and to protect images from fingerprints and contact with other surfaces. Mat board has some rag content and is available in archival quality. The surface of mat boards have uniform laid or woven textures. Use the texture of mat boards creatively when you draw in charcoal or pastels.

Erasers

Introduction

Everyone makes mistakes. You can imperceptively correct your mistakes if you know the correct eraser for the media. Poor erasures stand out.

Types of erasers

There are erasers you use by hand, electric erasers, and air erasers.

Hand-held erasers

You can use hand-held erasers to remove nearly any stray mark or error if you erase carefully. Hand-held erasers are available in different grades, each with a specific purpose.

SYNTHETIC ERASERS: Synthetic erasers are a new breed of erasers that are soft and nonabrasive. Used primarily on Mylars and vellums, they are not suitable for papers and dark marks. Moisten white synthetic erasers slightly before using them on Mylar. They are often bright white in color, but manufacturers have been producing them in wild array of colors. Synthetic erasers are made of nylon or plastic.

HARD ERASERS: Hard erasers have a lot of abrasive grit in their composition. You can feel the roughness when you drag your finger across the surface. Hard erasers act like sandpaper against paper fibers to remove unwanted marks. They are light grey or dull white in color. Although hard erasers remove dark marks, they tend to disrupt paper fibers making the erasure visible.

INTERMEDIATE ERASERS: Intermediate or moderately abrasive erasers erase most errors with little or no damage to surrounding paper surface. They are medium green or dark pink in color.

SOFT ERASERS: Soft erasers are used for light errors and stray marks, blending, and highlighting. Soft and pliable, the colors of these erasers are light green or light pink in color.

Continued on next page

Erasers, Continued

Hand-held erasers (Continued)

SPECIAL-PURPOSE ERASERS: Special-purpose erasers include art gum erasers, kneaded erasers, and pulverized eraser particles. The super-soft art gum eraser does not damage paper surfaces, but it will leave a crumbly residue. Art gum erasers are light beige. Kneaded erasers are light blue or light grey with the consistency of putty. This malleable substance absorbs graphite and pigment particles. Absorption increases by kneading these erasers in your hand. Generally, these erasers leave no residue unless they are too old or too full of absorbed particles. If these erasers become too warm, the substance may break down, leaving stains on drawing surfaces. A kneaded eraser hardens as it ages. Kneaded erasers are used for blending and for highlighting in drawings made with pencil, pastel, and charcoal. Pulverized eraser particles are nonabrasive and remove only the softest of stray marks. They are often used to clean smudges and smears from already completed drawings. They are available in a can to pour on a drawing, rub, and brush off. They are also available in an ABC pad which is a soft mesh bag full of particles that you rub against the drawing surface and brush off the residue.

The following table shows the types of erasers common to a work center.

| Eraser | Purpose | Color | Remarks |
|--------------|---|---|--|
| Synthetic | Pen and pencil marks on Mylar or vellum | White, amber, and a host of bright colors | Moisten eraser before using, leaves no residue |
| Hard | Dark pencils marks and light pen marks | Grey and red | Abrades paper surface, leaves no residue |
| Intermediate | General pencil marks | Medium green and dark pink | Leaves little or no residue |
| Soft | Light pencil marks, smudges, clean-up, and highlighting | Beige, blue, dark grey and light pink | May leave a crumbly residue |

Continued on next page

Erasers, Continued

Electric erasers Electric erasers are hand held units with power cords or rechargeable bases. They provide rapid and thorough erasures. The eraser nib is interchangeable depending on the degree of hardness you require to erase the medium.

To use an electric eraser, follow this table:

| Step | Action |
|------|--|
| 1 | Select the appropriate eraser nib for the media you are using. |
| 2 | Secure the nib into the shank of the electric eraser. |
| 3 | Isolate the unwanted area or protect surrounding areas with an erasing shield. |
| 4 | Turn on the eraser and lower over the error. |
| 5 | Move the eraser in a circular motion over the erasure taking care not to hesitate in one spot for long. Allowing the eraser to sit in one spot too long will bore a hole through the paper and bum the vinyl table covering. |
| 6 | Remove the eraser from the drawing surface. |
| 7 | Brush away the residue with a draftsman's brush. |

Figure 1-1 shows silhouettes of popular electric erasers.

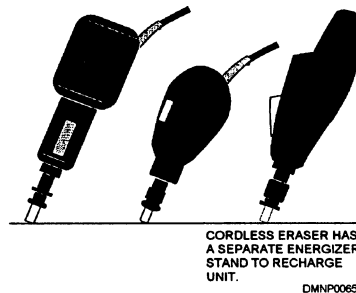

Figure 1-1.—Electric erasers.

Continued on next page

Erasers, Continued

Air erasers

Air erasers are air powered. The principle of operation is similar to that of sandblasting. Isolate unwanted areas and protect the rest of the drawing by masking with a frisket or masking tape. With a special airbrush and a compressor, eraser particles are shot at 35 pounds-per-square inch (PSI) at the drawing until the erasure is complete. You cannot use an airbrush intended for pigments because the size and nature of the abrasive grit will ruin the delicate parts of an airbrush intended for pigment.

Pencils

Introduction

The pencil is the most versatile and expressive media available to you. You can create a range of values from the subtlest grey to the richest black in a variety of line resolutions. For extended study in the versatility of the pencil or the pencil as a finish medium, review the work of contemporary artists Paul Calle and Gene Franks.

Selection

The selection of a lead pencil depends upon your personal preference and the intended end product. Your sensitive manipulation and pressure on the pencil controls the tones you produce. How you sharpen and hold the pencil determines the textural effects obtained and the size of the stroke. Pencil leads are available in 17 grades from 6B, the softest, to 6H, the hardest.

Figure 1-2 shows a chart of lead hardnesses and their applications.

| SOFT FREEHAND DRAWING | | | | | | MEDIUM FREEHAND DRAWING AND GENERAL LAYOUT | | | | | HARD TECHNICAL DRAWING | | | | | |
|--------------------------|----|----|----|----|---|--|---|---|----|----|---------------------------|----|----|----|----|----|
| 6B | 5B | 4B | 3B | 2B | B | HB | F | H | 2H | 3H | 4H | 5H | 6H | 7H | 8H | 9H |
| | | | | | | | | | | | | | | | | |

Figure 1-2.—Lead hardness.

Continued on next page

Pencils, Continued

Soft leads

Soft leads, that is, leads in the 6B to 2B range, are well suited to freehand drawing. They tend to be thick in core diameter and leave some graphite residue. Illustrations in soft lead tend to smear easily. Smearing and smudging are creative options with soft leads. Use kneaded erasers to bring out illustration highlights. When used on paper with pronounced grain or tooth, soft leads appear granular and black. Soft lead pencils are brittle and require more frequent sharpening than hard leads.

Medium leads

Leads in the range of B to 3H are medium hard leads. Ideal for general purpose layout work, they are dense enough to leave an image and easily erased. Graphite residue is minimal and the illustration has a light sheen to the surface.

Hard leads

Technical drawing and drawings that require a high degree of precision are done by hard-leaded pencils in the 4H to 6H range. Hard-leaded pencils have small diameter cores and hold points longer than soft leads. The lines appear light and have a high sheen. Heavy pressure on hard-leaded pencils creases the paper and is difficult to thoroughly erase.

Humidity

Humidity affects the graphite core of lead pencils. On dry days, the pencil leaves more dust or residue than on days of high humidity. On damp days, pencil lines appear more black or dense. When continuing a pencil drawing on a day of high humidity, you may have to select a lead that is a few degrees harder than the lead you would use on a dry day.

Variation

You may find that as you master the medium of the pencil, you may increase the selection of pencil leads at your disposal.

Continued on next page

Pencils, Continued

Holding the pencil

Hold your pencil comfortably and naturally. Grip the pencil lightly. To draw light lines, use little pressure. To draw heavier lines, increase pressure. Create texture by changing the angle of the pencil to the paper surface and use the point or side of the lead. Generally, the two ways of holding a pencil are the normal writing position and under the palm. In the normal writing position, you have control for tight or small details. Holding the pencil under the palm allows you to use free-flowing wrist or arm action to draw larger or to draw with less restriction.

Figure 1-3 shows the two ways of holding a pencil.

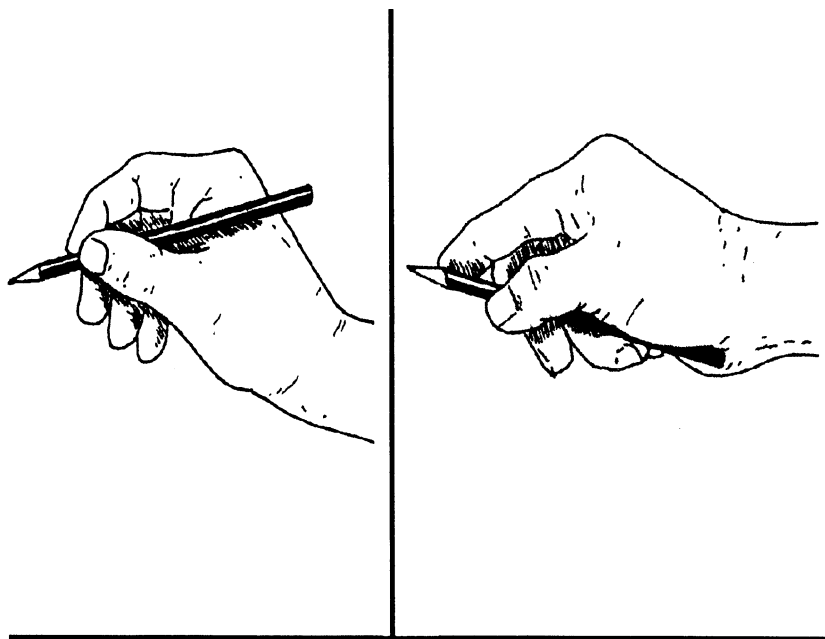

DMV30075

Figure 1-3.—Holding a pencil to draw.

Continued on next page

Pencils, Continued

Position of the arm and body

One of the tendencies of novice illustrators is to curl up and form a compact, tight position between the arm and the torso before starting to draw. The drawings you produce from this position also tend to be tightly rendered and small. This position often leads to an overworked drawing. It takes a concerted effort to open up your stance and allow your arm freedom of movement.

Warm-up exercises

Warm up your arm and hands with a few simple, quick exercises. Select a large pad of paper and a crayon. Draw mass areas only, no details. Use a timer set for 30 seconds, select a subject in the room like a chair or a DM3 and begin to draw. At the end of 30 seconds, switch views or positions. Do this for 3 minutes. Now set the timer for 3 minutes. Draw. Repeat this three times. You should now be sufficiently prepared to begin seriously drawing. This is also a good exercise to practice at shopping malls where there is a large variety of subject matter.

Figure 1-4 shows how a practice or warm-up drawing should appear.

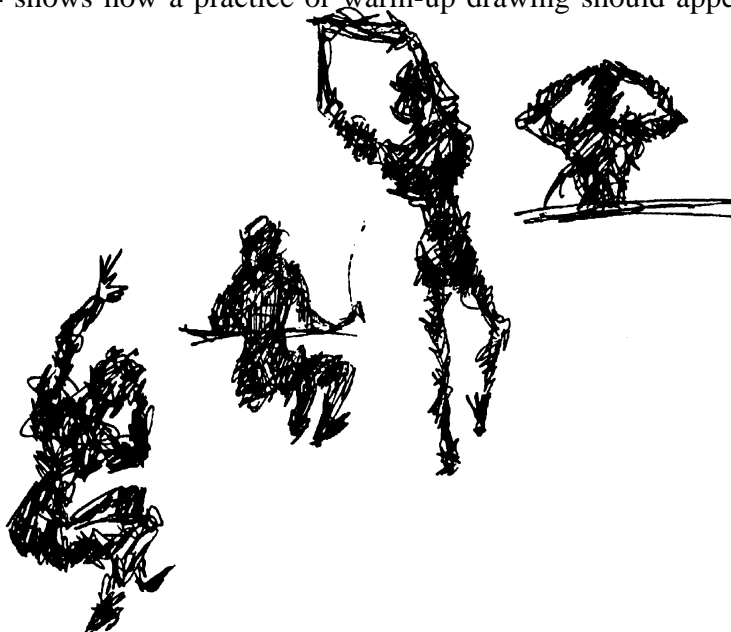

DMV30088

Figure 1-4.—Practice drawings.

Continued on next page

Pencils, Continued

Sharpening a pencil

The shape of the pencil lead defines the textural quality and the stroke width of the line you draw. A pencil lead may be conical, elliptical, chiseled, beveled left or right, or flat in shape. Softer leads require sharpening more often than hard leads. Three sharpeners used to sharpen pencil leads are regular office sharpeners, draftsman's sharpeners, and sandpaper pads.

Figure 1-5 shows the shapes of pencil leads.

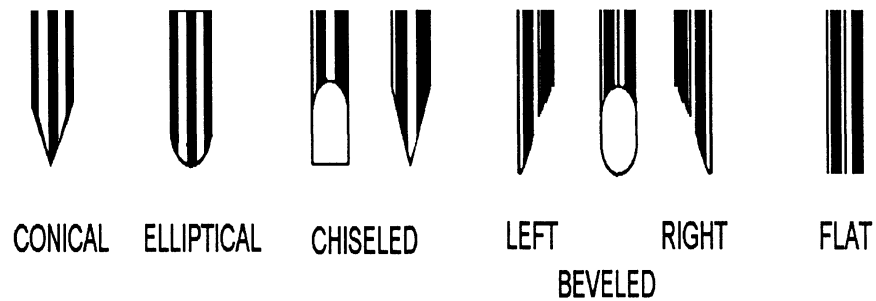

DMV30089

Figure 1-5.—Shapes of pencil leads.

Continued on next page

Pencils, Continued

Regular office pencil sharpener

The regular office pencil sharpener sharpens the pencil lead to a conical point. It both shaves away the wooden casing and shapes the lead core. Although a conical point is excellent for drawing thin, precise lines, you must maintain point consistency by sharpening often.

Draftsman's pencil sharpener

Unlike the regular office sharpener, the draftsman's sharpener does not shave away the wood case around the lead core. The draftsman's sharpener shapes only the lead. Expose the lead core approximately 3/8 inch by either cutting away the wood with a knife or releasing the lead from the mechanical pencil handle. Insert the lead into the draftsman's pencil sharpener and rotate the sharpener top. This contacts the pencil lead with a replaceable sandpaper tube inside the sharpener and creates a conical point.

Figure 1-6 shows a draftsman's pencil sharpener.

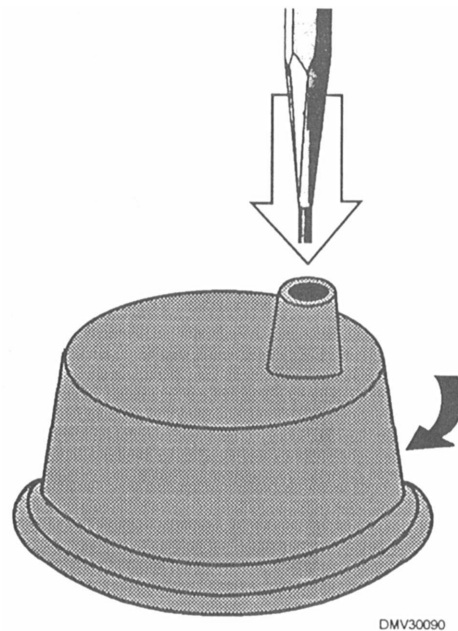

Figure 1-6.—The draftsman's pencil sharpener.

Continued on next page

Pencils, Continued

Sandpaper pad To sharpen a lead pencil to a elliptical, chiseled, beveled, or flat tip requires a sandpaper pad. A sandpaper pad is sheets of sandpaper lightly glued at the edges to a small wooden paddle. Expose approximately 3/8 inch lead by shaving away the wood case around the lead or advancing lead from a mechanical pencil and rub the lead against the sandpaper to shape the point you desire. Keep your hands free of residue. Clean your hands and work space before working on illustrations.

Figure 1-7 shows a sandpaper pad.

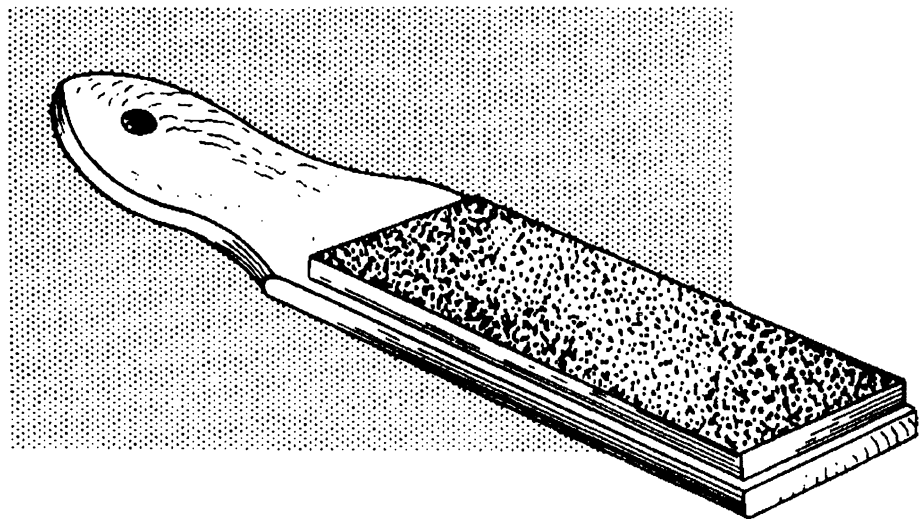

DMJA0091

Figure 1-7.—Sandpaper pad with wooden handle.

Continued on next page

Pencils, Continued

Sandpaper pad (Continued) To sharpen a lead to a conical point with a sandpaper pad, follow this table:

| Step | Action |
|------|--|
| 1 | Expose 3/8 inch of lead. |
| 2 | Lay the lead against the sandpaper pad at a steep angle. (See figure 1-8) |
| 3 | Draw the lead back and forth across the sandpaper while simultaneously rotating the pencil between your fingers to create an evenly sharpened point. |
| 4 | Clean work space and wash hands before working on an illustration. |

Figure 1-8 illustrates the angle of the lead to the sandpaper pad.

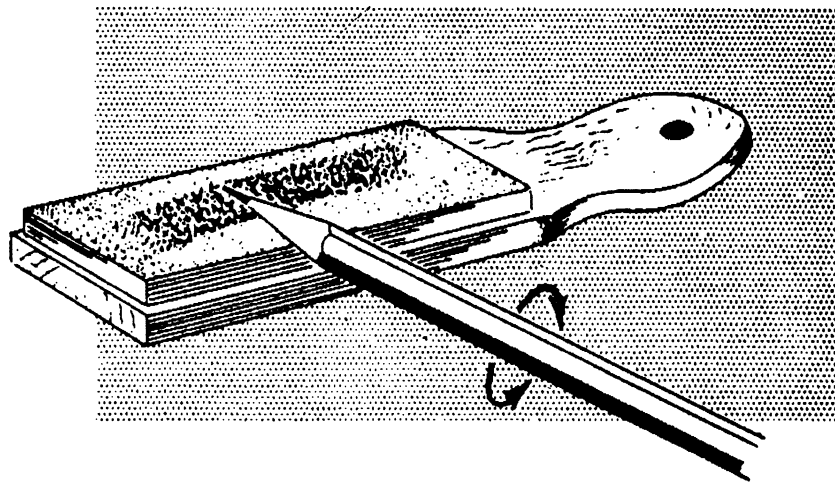

DMJA0092

Figure 1-8.—Using a sandpaper pad to sharpen lead to a conical point.

Continued on next page

Pencils, Continued

Sandpaper pad (Continued)

To sharpen a lead to a chiseled, beveled, or flat point with a sandpaper pad, follow this table:

| Step | Action |
|------|--|
| 1 | Expose 3/8 inch of the lead. |
| 2 | Hold the lead against the sandpaper pad at an angle. (See figure 1-9.) |
| 3 | Draw the lead back and forth across the sandpaper. |
| 4 | Turn the pencil around 180 degrees. |
| 5 | Draw the lead across the sandpaper to approximately the same angle and depth as the other side. This will produce a chisel point. |
| 6 | Drawing the lead across the sandpaper favoring the left or right side or drawing the tip across the sandpaper at a 90-degree angle produces a left-beveled, right-beveled, or flat lead point. |
| 7 | Be sure to wash you hands and clean the surrounding area of graphite particles before drawing. |

Figure 1-9 illustrates the angle necessary to produce a proper chiseled, beveled, or flat point.

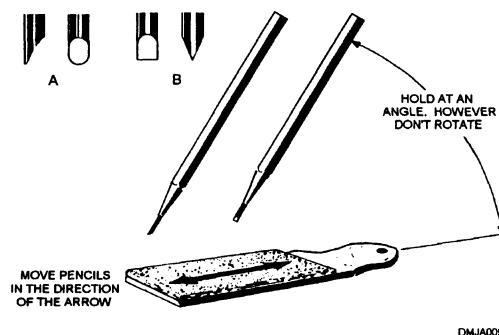

Figure 1-9.—Using a sandpaper pad to sharpen lead to either an elliptical point (A) or chisel point (B).

Continued on next page

Pencils, Continued

Line weight

The weight of lines drawn with pencils varies according to the pressure and direction of the stroke. You have probably already noticed that pencil lines widen as you approach the end of the stroke. Also, lines may increase or decrease in weight when you change direction of the stroke. Add interest, depth, and sensitivity to drawings by varying line weights.

Figure 1-10 shows various line widths possible with the pencil.

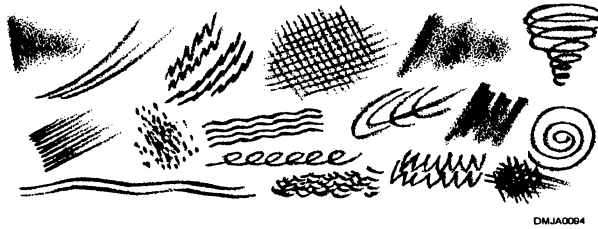

Figure 1-10.—Various line widths possible with the pencil.

Texture

You can create the illusion of texture with pencil strokes. Crosshatching can duplicate shades of grey. Broad strokes against illustration boards with a high tooth resembles concrete or stucco. You can infer texture without drawing every line in the pattern.

Figure 1-11 shows how you can imply a texture without drawing every line.

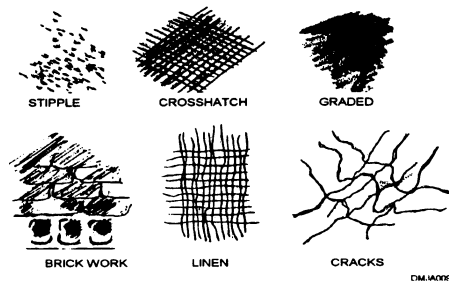

Figure 1-11.—Indicating texture.

Continued on next page

Pencils, Continued

Tone

Pencil drawings may range from the white of the illustration board to the densest black of graphite. Pencil drawings may be continuous tone or line drawings. The paper you select for your pencil drawing determines degree of texture. The technique and media you select determine the density of tone.

Figure 1-12 shows texture and tone created by pencil strokes.

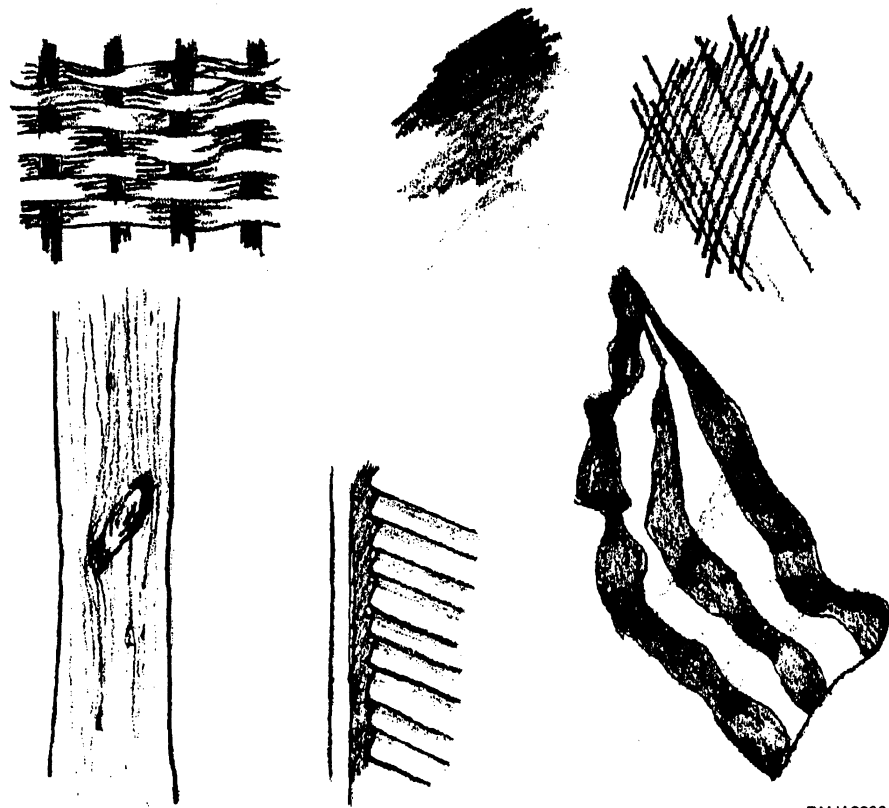

DMJA0096

Figure 1-12.—Texture and tone created by pencil.

Continued on next page

Pencils, Continued

The pencil illustration

Once you select the pencils, eraser, and paper, you are ready to begin illustrating. Start with a few thumbnail sketches to determine the angle of view, perspective, and mass tonal ranges. Using a medium grade pencil lightly over the paper surface, block in or sketch the main outlines in the drawing. Do not be too concerned with details at this point. Strive to correctly portray scale and perspective. Next, use a soft lead to place the light tones, then use an even softer lead to make the darker tones. Placing the light tones first will enable you to gage the tonal quality of the image to control the overall tonal key. Finish the drawing by adding details. At this point, use tortillions or stumps to blend strokes or the kneaded eraser to bring out the highlights. Switch to a harder pencil lead to draw fine or precise details. Keep erasures to a minimum. Keep the illustration clean.

Figure 1-13 shows the steps for developing a pencil illustration.

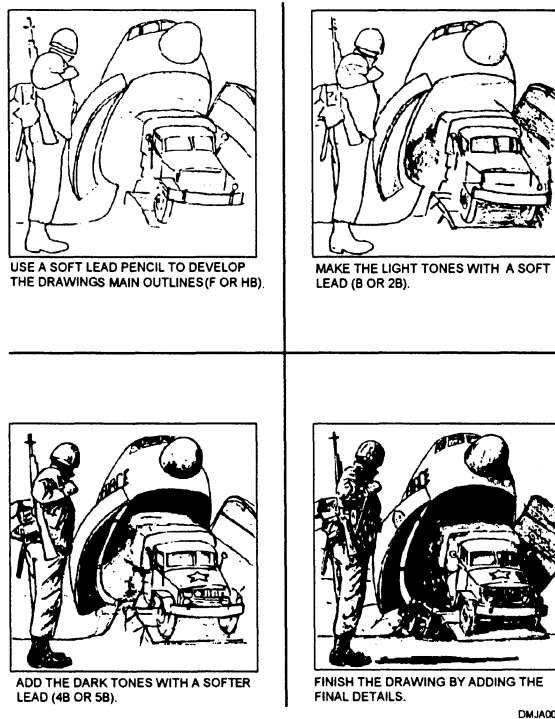

Figure 1-13.—Steps for developing a pencil illustration.

Continued on next page

Pencils, Continued

Color pencils

The primary difference between color pencils and graphite pencils is how easily color deceives when rendering tonal values. Color pencils handle the same as graphite pencils and create the same range of effects. Relatively new to fine arts rendering, the degree of permanence of color pencils is not certain. When creating illustrations in color, you have additional concerns about color compatibility, adjacency, and tonal reproduction. Refer to chapter 2, “Color Theory.”

Carbon pencils

Carbon pencil lead is made of synthetic materials. These leads produce dense, dull, black lines that are not easily erased. They come in a variety of degrees of hardness. The softer leads are more versatile than the hard leads because the softer leads deposit their pigment more easily. Hard leads have a greater amount of binder, are more brittle, and are less dense in deposit.

Brushes

Introduction

A good paint brush is an asset, as is the knowledge of matching brushes to the media you intend to apply. Proper cleaning and storage of paint brushes will result in brushes maintaining a useful life for many years.

Paint brushes

Lettering, illustrations, and paintings are done with paint brushes that vary in composition but have similar physical characteristics. Brushes are composed of bristles or hair, a ferrule or quill, and a handle.

Figure 1-14 shows brush nomenclature.

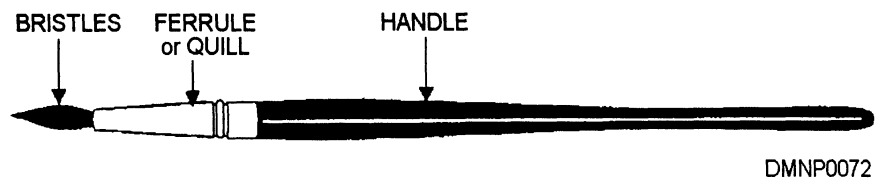

Figure 1-14.—Brush nomenclature.

Continued on next page

Brushes, Continued

Brush bristle nomenclature and testing

Paint brush bristles or hair have flattened, split ends called flags. The flags enable the bristles to trap pigment and move it around. The end of the bristles, enclosed by the ferrule, is referred to as the butt. Here brush deterioration generally begins with trapped pigment rotting the bristles. When judging bristle elasticity, you should bend the bristles at a 45-degree angle to a horizontal surface and observe where the bristles bend. The bend should occur approximately 1/3 the length from the ferrule. The bend of the bristle is called a heel. A brush that is too stiff to bend or bends too near the tip is an inferior brush.

Figure 1-15 shows bristle nomenclature.

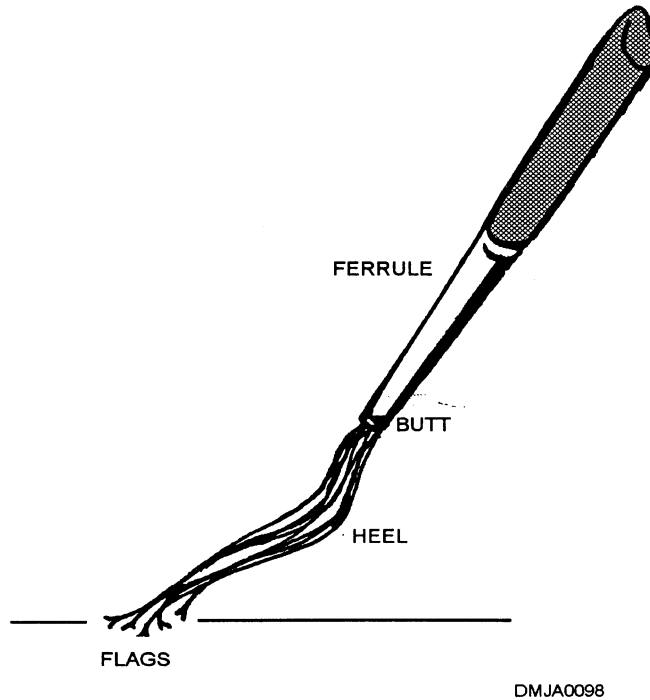

Figure 1-15.—Bristle nomenclature.

Continued on next page

Brushes, Continued

Brush bristles

Once collected and bound by hand, bristles were made from the hair of the tail of a kolinsky . Bristles are now made from hog, sable, squirrel, ox, goat, and camel hair, and synthetic materials such as nylon. Hog hair bristles are often used for oil painting. Sables are most responsive when used with water soluble pigments and ink washes. You can use sable brushes with oil and acrylic pigments; but, the heavier bodied pigments inhibit the natural spring in the brush. Squirrel, ox, and camel hair bristles and synthetic bristles are suited to a variety of pigments. These bristles have less spring and stand up well to paint and solvents. Oriental brushes used for calligraphic work and sumi-e are made of goat hair.

Bristle length

The length of brush bristles affects how easily you can apply paint with a brush. Short bristles tend to dig and shovel paint around the surface. Bristles that are too short or that have been trimmed from longer bristles are no longer good for painting. Long bristled brushes do not allow exact placement of pigment to a surface because of the flexibility of the bristles. Correct bristle length allows accurate placement and smooth covering of pigments.

Brush shape

The four common brush shapes are the fan, round, flat, and bright.

Figure 1-16 shows the common shapes of paint brushes.

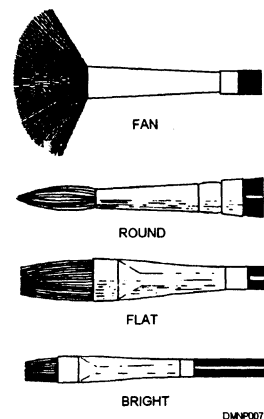

Figure 1-16.—Brush shapes.

Continued on next page

Brushes, Continued

Fan-shaped brushes

Fan-shaped brushes have their bristles spread out at the tip. Fan-shaped brushes are relatively new and work well with washes and large areas of pigment. Fan-shaped brushes also work well as blenders. Their bristles are often made from synthetic materials and are very durable. You can use fan-shaped brushes with any pigment.

Round-shaped brushes

Round-shaped brushes are normally made with sable or synthetic material. The round shape of the bristles hold more pigment than flatter brushes. The size of brushes varies; but, even the larger brushes are responsive to an experienced painter.

Flat brushes

Flat-shaped brushes are called flats. Flats have long bristles with a square-cut tip. It is difficult to apply paint with flat bristles because of the elasticity of the bristle. Flats are better suited for fluid strokes and blending. Flats will work well with any pigment.

Bright brushes

Brushes called brights also have a square-cut tip, but a shorter bristle length than a flat. The relatively short bristle of brights allows the painter to readily apply and maneuver pigment over a surface. Brights work well with any pigment.

Brush size

The size of a brush is written on the ferrule or handle of the brush. The bristle capacity of the ferrule determines brush size. Manufacturers use different size indicators, but they are generally numeric beginning with No. 00000 as the smallest.

Ferrule

The ferrule is the sleeve that binds the bristle to a brush handle. The sleeve may be made from metal, plastics, or natural quill. Some oriental brushes use copper wire. The ferrule is the most vulnerable point of the brush. Residual pigments and solvents tend to collect at the ferrule and accelerate deterioration. Bristles become brittle and break at the ferrule.

Continued on next page

Brushes, Continued

Handles

Handles made of wood or plastic hold the ferrule and the bristles. Oriental brush handles are made of bamboo or twigs. People give relatively little thought to brush handle length, but a handle that is too long or too short will imbalance the hand as it travels across a surface. Use short-handled brushes when you are working close to a surface and for detail work. Long-handled brushes can counterbalance the brush tip and are better suited for expansive areas without well-defined detail.

Cleaning brushes

After using a brush, clean it thoroughly. A brush properly cared for will last many years. Throw away brushes with crusted and curled bristles or reuse them as disposable paste brushes. Do not trim brush tips and continue to use them because the bristles will not respond correctly. In particular, keep the area around the ferrule clean. Shape and store the brush after cleaning.

To clean, shape, and store brushes, follow this table:

| Step | Action |
|------|---|
| 1 | Remove as much color as possible by initially rinsing brushes: <ul style="list-style-type: none">● in water for water-based paints, and● in thinner or mineral spirits for oil-based paints. |
| 2 | Wet brush in lukewarm water after removing all color. |
| 3 | Lather palm of hand with mild face soap. |
| 4 | Stroke brush back and forth in hand. |
| 5 | Rinse thoroughly in clean water. |
| 6 | Shake excess water from bristles. |
| 7 | Shape bristles gently into original shape. |
| 8 | Store brushes with bristles up. |

Continued on next page

Brushes, Continued

Shaping brushes

After cleaning, you should shape the bristles of the brush into their original shape. If you do not, the bristles will dry curled and the brush will no longer work well. With your fingers, gently shape the brush so that each bristle holds together and forms a tip. Place brushes in a drying or storing rack.

Storage

Store brushes in a clean condition and never allow a brush to dry or rest on its bristles. Place brushes bristles up in a glass or in a mug. Use a brush holder to store brushes when they are not in use or after cleaning. Do not allow pressure on brush bristles to curl the bristle. Store brushes in an enclosed area to minimize airborne contaminants and dust.

Figure 1-17 shows correctly stored brushes.

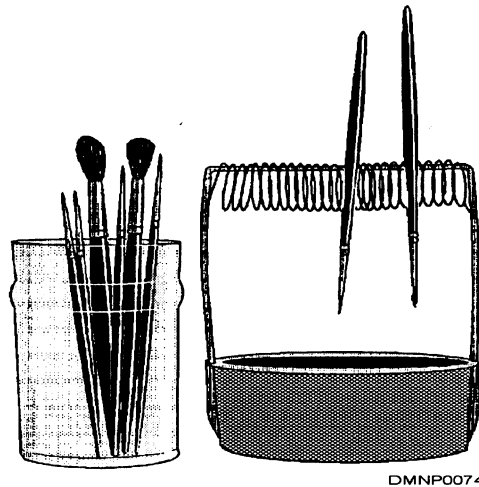

Figure 1-17.—Correctly stored brushes.

Storing oil brushes

If you use both water- and oil-based pigments, dedicate a set of brushes for oil-based pigment only. Once you use a set of brushes in oil pigment, they may retain residue oils that could ruin watercolor. Brushes used in watercolor, then used for oil-based pigment, may release water droplets that sit on the oil paint surface and retard drying. After cleaning oil-dedicated brushes and before storing them, add a drop of oil to the bristles. This keeps the bristles pliable and lessens the effects of harsh cleaning solvents.

Pen and Inks

Introduction

Pen nibs and reservoir pens are made by many different manufacturers and in a variety of styles. Proper care and correct use can prolong the useful life of pen nibs and reservoir pens. For extended study of pen and ink drawing, review the works of M. C. Escher and Edvard Munch.

Pen nibs

Pen nibs detach from handles or drawing instruments. There are drawing nibs and lettering nibs. After you select an appropriate pen nib, make sure the nib is clean. If a nib has not been used before, moisten it slightly to remove the manufacturer's protective oils. Do not fill a pen nib more than 3/8 inch up the nib blade. This prevents the nib from bleeding on the paper surface.

Drawing nibs

In general, nibs used for drawing have more spring than lettering nibs. Like a pencil, varying the width of the stroke creates a line that is more sensitive and interesting. Some nibs are so stiff that excessive pressure gouges the paper surface by disturbing the fibers. Torn fibers absorb the ink giving lines a fuzzy appearance. Other nibs have more spring that allows you to vary line width. Quill-nibbed pens produce an extremely fine line and are very responsive.

Figure 1-18 shows quill pen nibs.

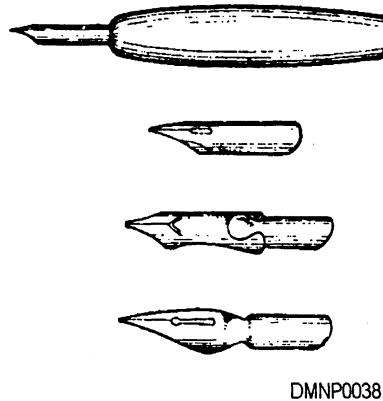

Figure 1-18.—Quill pen nibs.

Continued on next page

Pens and Inks, Continued

Lettering nibs

Lettering nibs are pen points used primarily for lettering or calligraphy. Some lettering nibs have hinged blades serving as ink reservoirs. Lettering nibs are available for right- and left-handed artists. The difference is the angle of the nib where it contacts the paper surface. Lettering nibs have five basic shapes: the square, the round, the oblong, the oval, and the split nib. The split-nibbed lettering pen is often called a spencerian nib after the spencerian alphabet that it is particularly suited for creating.

Figure 1-19 shows five common lettering nib shapes.

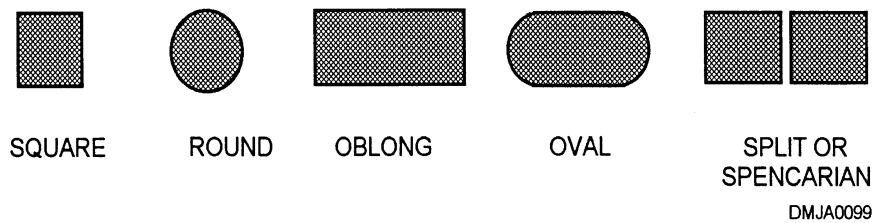

Figure 1-19.—Common lettering nib shapes.

Continued on next page

Pens and Inks, Continued

Reservoir pens Reservoir pens, sometimes referred to as technical pens, have a pen nib, a feed system, and an ink reservoir. Reservoir pens have conical or tubular tips. Tubular-tipped reservoir pens attach to the scribe of hand lettering devices. Reservoir pen nibs create lines of uniform width. The feed system is a weighted, gravity-fed needle that regulates ink flow. The reservoir is a refillable plastic cartridge attached to the feed system and housed inside a handle. The pen is ready to use when you hear a light clicking sound made by the weighted needle as you gently shake a pen up and down.

Figure 1-20 shows an exploded view of a reservoir pen.

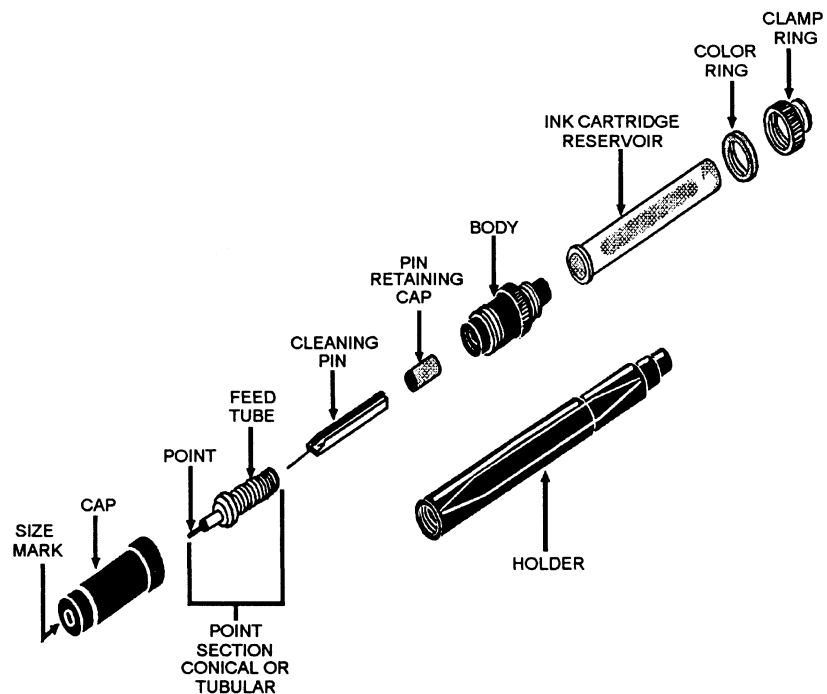

DMNP0039

Figure 1-20.—An exploded view of a reservoir pen.

Continued on next page

Pens and Inks, Continued

Reservoir pens (Continued)

To use a reservoir pen, follow this table:

| Step | Action |
|------|---|
| 1 | Remove the holder, clamp ring, and ink cartridge reservoir. |
| 2 | Fill the reservoir two-thirds full of drawing ink. |
| 3 | Holding a tissue over the pen nib, replace the reservoir, clamp ring, and holder. |
| 4 | Gently shake the pen up and down away from the drawing surface allowing the weighted needle to feed ink into the feed tube. |
| 5 | Moisten a tissue and touch the pen nib to it until ink appears. |
| 6 | Hold the pen between thumb and forefinger perpendicular to the drawing surface. |
| 7 | Keep tissue near to remove excess ink and paper fibers from the nib as necessary. |

Figure 1-21 illustrates a correctly held reservoir pen.

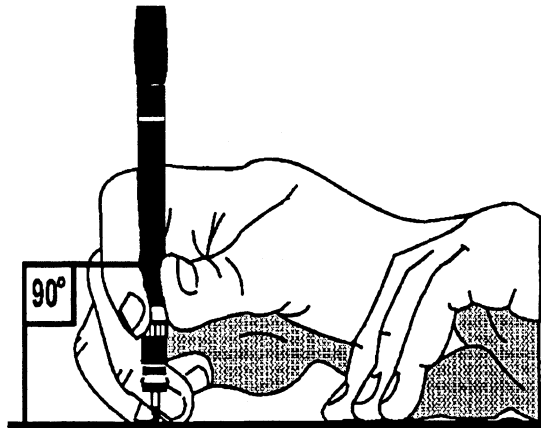

DMNP0040

Figure 1-21.—Holding a reservoir pen correctly.

Continued on next page

Pens and Inks, Continued

Improper pen handling

Holding pen nibs or reservoir pens to the paper surface incorrectly may result in undesirable lines that have defective resolution.

Figure 1-22 illustrates the consequences of improper use of the pen and insufficient ink.

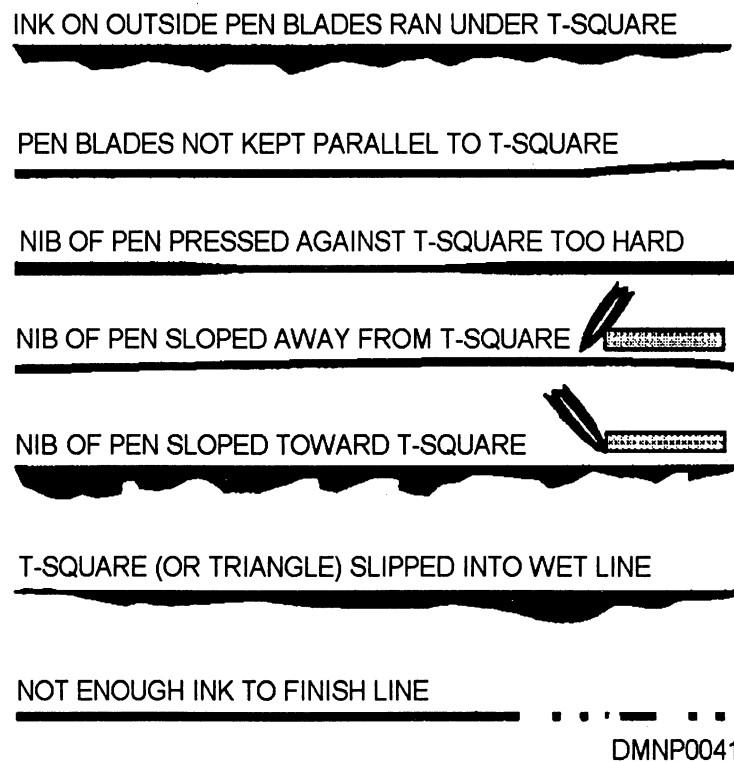

Figure 1-22.—The consequences of improper pen handling and running out of ink.

Continued on next page

Pens and Inks, Continued

Pen care

Pen nibs and reservoir pens must be kept clean. Crusted ink will ruin a drawing in progress and permanently freeze a technical pen. Pen nibs should be cleaned in warm water with mild detergent. Use water and ammonia to remove stubborn ink. Do not leave reservoir pen parts in an ultrasonic cleanser for more than 10 minutes. Heat from the vibrating cycles will melt the plastic parts of the pen. Before you clean a reservoir pen, consider the following guidelines:

- thoroughly clean pens before periods of nonuse, an idle pen floods with ink that coagulates, preventing the needle weight from moving freely to distribute ink into the nib,
- disassemble the pen only for thorough cleaning to prevent damage to the fine wire needle in the nib, and
- handle all parts carefully.

To clean a reservoir pen, follow this table:

| Step | Action |
|------|---|
| 1 | Remove the holder, clamp ring, and reservoir. |
| 2 | Empty cartridge, rinse, and set aside to dry. |
| 3 | Remove the cap, rinse, and set aside to dry. |
| 4 | Loosen point section before soaking: do not force pen section loose, instead allow to soak and renew attempt to loosen. |
| 5 | Soak pen in water and ammonia or mild detergent. |
| 6 | Rinse well. |
| 7 | Thoroughly dry pen parts before reassembly. |

Continued on next page

Pens and Inks, Continued

Ink

Ink is a water-soluble emulsion of opaque pigment. Ink comes in colors, but the most opaque and the color you will be most familiar with is black. Although you can thin ink with water, once ink dries it becomes waterproof. Old ink is no longer useful. The emulsion separates or the pigment thickens. If the ink has separated, throw it away. If the ink has thickened, you may be able to salvage it by adding a small quantity of water. Thinning ink with water reduces opacity.

Ink drawing

Drawings made in ink are referred to as line drawings. The image is black and white. Areas that appear grey do so only by textural variation.

Textural variations

Stipple and crosshatch are examples of textural variations. How light or dark areas appear depends on the ratio of black ink lines to the white paper space between the lines. When rendering textural effects, make sure the first set of lines dry before crossing them with another. If you do not, the lines pool and blur or the paper becomes saturated and the pen nib tears the paper fiber.

Figure 1-23 shows lines made by a variety of pens and brushes.

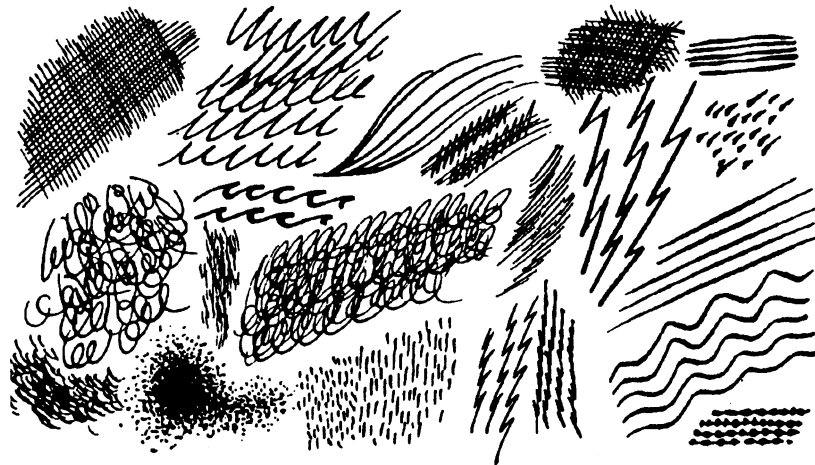

DMJA0100

Figure 1-23.—Varied effects with different pen points and brushes.

Continued on next page

Pens and Inks, Continued

Drawing over pencil lines in ink

You may draw in ink over lines previously drawn in pencil. The pencil sketch may be drawn directly on the paper surface or on tracing paper and transferred to the paper surface. After the inked in portion of the drawing is complete, remove the graphite underdrawing with a soft eraser. If the basic pencil drawing contains too much graphite, the ink will crawl, or roll away from the pencil line. Should this occur, carefully remove some of the graphite with a soft eraser.

Ink washes

Drawings made in diluted ink with a brush are called washes. Washes are continuous-tone renderings. Washes are difficult to control because of the amount of water in the medium and have very little latitude for correction. Ink washes require preparation and planning.

Preparing for ink washes

Before putting the brush to paper, you must do a basic drawing, prepare the paper surface, and mix the value range of your washes.

Preparing a paper surface

Washes are painted on watercolor paper. The weight of the paper determines whether or not you need to fix the paper to a solid surface before painting. This procedure is called stretching the paper. Thin paper that is not stretched will curl and buckle during the painting process. Thick paper, rated at 300 lbs or more, does not require stretching.

Stretching the Paper

To prepare watercolor paper, follow this table:

| Step | Action |
|------|--|
| 1 | Select a paper and allow it to soak fully submerged in lukewarm water for approximately 20 minutes. |
| 2 | Remove the paper from the water and place it on a solid board. |
| 3 | Using craft-paper tape, tape all around the edges of the paper. |
| 4 | The paper is ready for use when the sheen of the water disappears from the paper surface. You can also wait until the paper is completely dry. |

Continued on next page

Pens and Inks, Continued

Basic pencil drawing

Develop a drawing by sketching the outlines of the image with a pencil in the H to 2B range. Determine tonal areas and highlights. Mask or protect areas that you do not want to paint. You may use masking tape, rubber cement, or a commercially prepared liquid frisket.

Preparing the pigment

The pigment you use may be lampblack, inks, or watercolor. The procedure is the same. Mix values using a large amount of water and a little pigment for lighter tones and little water and more pigment for dark tones. Prepare a sufficient amount of wash to complete an entire drawing. It is difficult to remix an exact duplicate of a specific value that you have used. Save the wash in small jars or a palette with a lid. A palette is a tray for holding and mixing paint.

Assemble tools

Assemble any additional tools you require before you begin painting. Once begun, you should not leave the wash until you finish it. Additional tools include containers of clean water, sponges, extra jars, clean rags, special effects materials, and brushes.

Special effects materials

Special effect materials are items that create an effect with water and pigment. For example, salt repels pigment leaving small white dots. Sponges absorb pigment and water leaving a mottled effect on the paper. You may also spray an enamel or lacquer into wet images for an interesting reaction. Experiment with different items to find out what effect appeals to you.

Brushes

Assemble the sable brushes you are most comfortable using. A No. 3 and No. 5 are common wash brushes. Have a few larger sizes for those large areas of paper. Keep the brushes clean by flushing them often with clean water.

Continued on next page

Pens and Inks, Continued

Working in wash

You have assembled all materials, drawn an image, and are ready to begin working in wash. Position the board and the paper surface at approximately a 25 to 30-degree angle to each other to encourage the wash to flow toward the bottom of the paper. Keep the area you are working in moist to lessen the visibility of each brush stroke.

To work a flat wash, follow this table:

| Step | Action |
|------|--|
| 1 | With all material assembled, moisten the surface of the watercolor paper (if the paper is dry) or begin the wash when the sheen of the water leaves the paper surface (just after stretching). |
| 2 | Moisten the immediate area around the area you intend to work. |
| 3 | Select a brush that will allow you to make one complete stroke in the area you are painting without reloading. |
| 4 | Load the brush with wash. Stroke the brush against the edge of the wash container so you may move your brush to the paper without dripping wash. |
| 5 | Apply the wash from the upper-left corner working from left to right across the paper. |
| 6 | Reload the brush and work from right to left overlapping the puddle at the bottom edge of the previous stroke. |
| 7 | Continue until the wash is complete. |
| 8 | Squeeze excess wash from your brush and soak up the puddle at the bottom of the last stroke. |
| 9 | Set aside to dry. |
| 10 | Continue with the remaining image or remove all masks and friskets. |

Continued on next page

Pens and Inks, Continued

Working a wash (Continued)

Figure 1-24 illustrates the steps in working a flat wash.

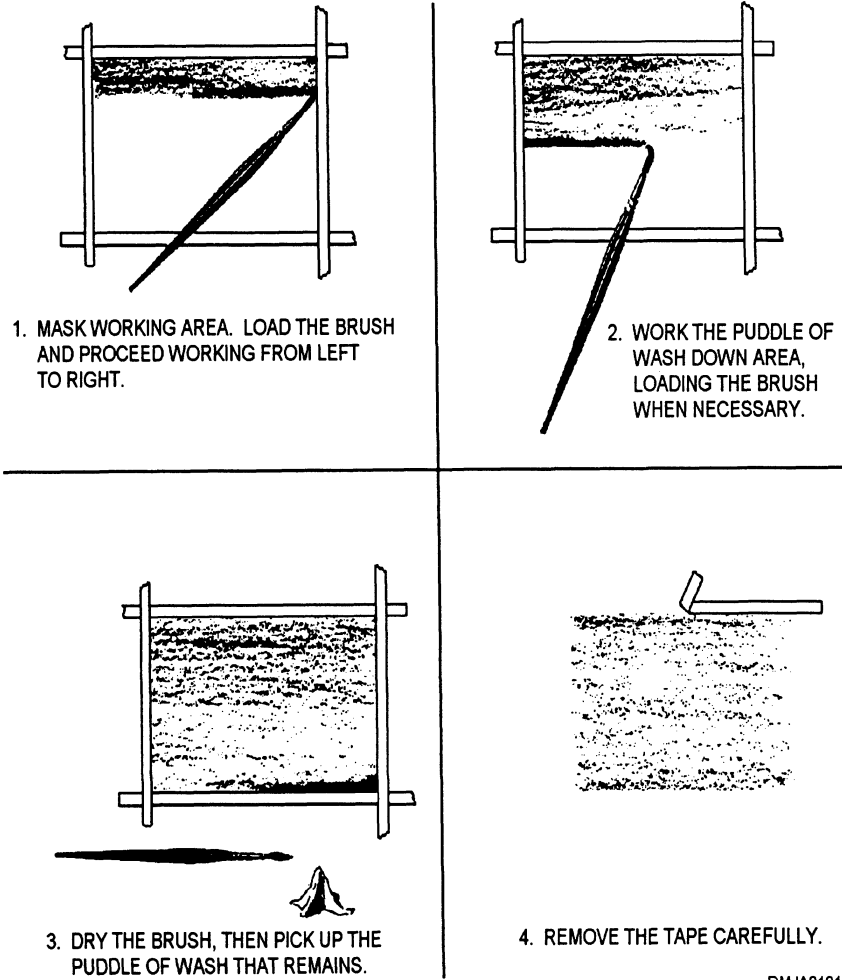

Figure 1-24.—Steps in working a flat wash.

Continued on next page

Pens and Inks, Continued

Graded washes Graded washes are washes in which the pigment goes from light to dark or dark to light. Prepare your board as you did for the flat wash. For light areas use a wash that has little pigment and proceed to stronger washes. Start at the top of the page with either the lightest wash or the darkest wash.

Figure 1-25 illustrates procedures for painting a graded wash.

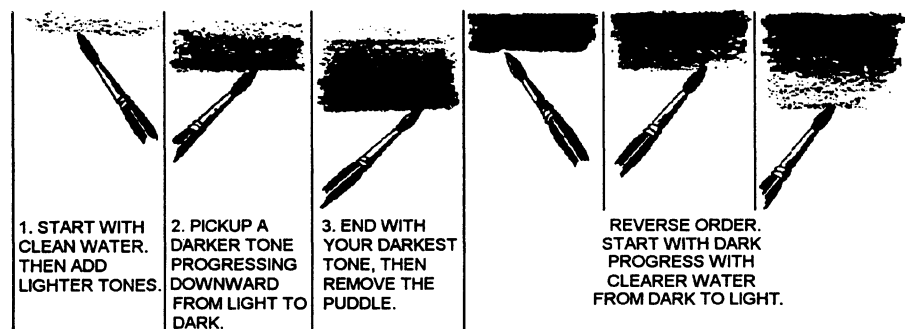

DMJA0102

Figure 1-25.—Steps for painting a graded wash.

Continued on next page

Pens and Inks, Continued

Indefinite blends

An indefinite blend is a portion of a painting where the applied pigment settles on the paper surface without manipulation. The effects are random within the designated area of the indefinite blend. Select an area to create an indefinite blend, clouds in a sky, for example. Moisten only the area the indefinite blend is to occupy. Add one or two darker tones. Select tones that are darker than the tone you want in the finished picture as washes dry lighter than they appear wet. Excess water will randomly carry the pigment across the paper surface. When the moisture evaporates, the pigment will settle leaving a soft-edged image of what you should perceive as clouds.

Figure 1-26 illustrates the procedure for creating an indefinite blend.

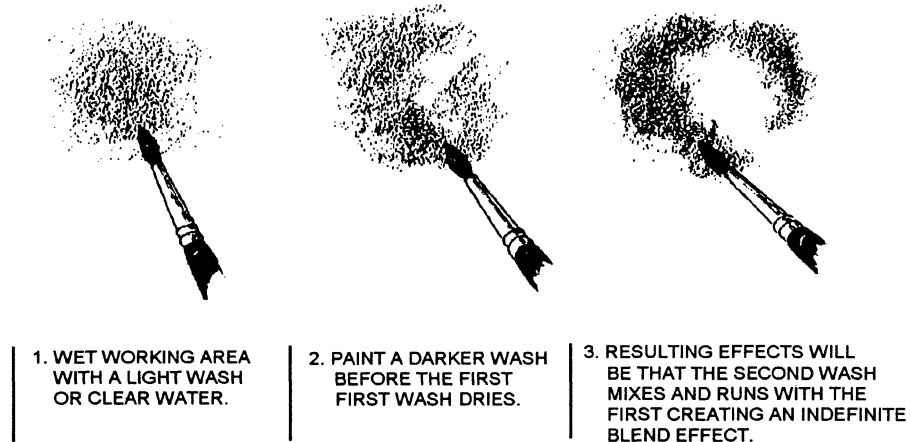

DMJA0103

Figure 1-26.—Creating the indefinite blend.

Pastels and Charcoals

Introduction

Charcoal and pastels are similar in traditional application and in their painterly effects. Select paper surface texture carefully because this texture will dictate the overall appearance of charcoal or pastel drawings. For an extended study of charcoal and conté crayon drawings, review the work of Michelangelo, Rubens, and Rodin. To review sensitive renderings in pastel, study Mary Cassatt and Edgar Degas.

Charcoal

Charcoal is carbonized willow twigs. Sometimes called vine charcoal, it produces a dense black, dull image and leaves a powdery residue. Charcoal sticks may be encased in a sleeve of wood like a pencil.

Degrees of hardness

Charcoal is available in different degrees of hardness. Extended carbonization increases the hardness of charcoal. As charcoal becomes harder, it is less useful as a drawing medium.

Drawing with charcoal

Charcoal is a drawing medium. Charcoal is an excellent medium to use when practicing drawing exercises. Select charcoal in a degree of hardness according to your preference. Handle the charcoal stick as you would a pencil. Pay particular attention to removing the dust that builds up with each stroke. Blend large areas with stumps or tortillons and create highlights with soft, hard, and kneaded erasers. The images produced by charcoal are dense.

Figure 1-27 shows vine charcoal.



Figure 1-27.—Vine charcoal.

Charcoal finishing

Charcoal drawings require fixative when complete.

Continued on next page

Pastels and Charcoals, Continued

Conté crayon Conté crayons are pigment compressed with a binder into stick form. Conté crayons come in white, black, sanguine, bistre, and shades of grey. Sanguine was a favored medium of the old masters. Bistre is often used with washes.

Degrees of hardness Conté crayons are available in different degrees of hardness. The crayon produces thin, dense, dull lines. Use them on their side for broad swatches of pigment. They are small in diameter and length.

Drawing with conté crayon Conté crayon is a drawing medium. Select a crayon according to your preference. Handle the crayon as you would a pencil. Dust is less likely to build unless your strokes are extremely heavy. Blend large areas with stumps or tortillons and create highlights with soft, hard, and kneaded erasers. Although often used for preliminary sketches, conté crayon drawings also create fine finished drawings.

Figure 1-28 shows conté crayons.

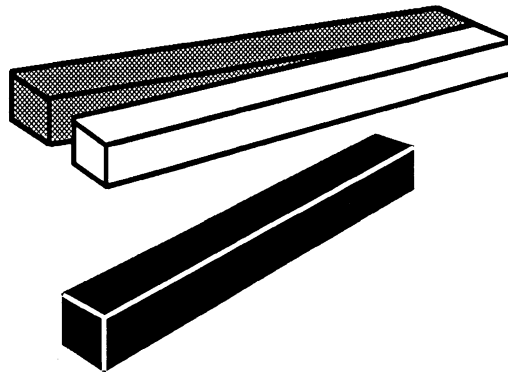

DMJA0105

Figure 1-28.—Conté crayons.

Conté crayon finishing You should spray conté crayon drawings with a fixative when complete.

Continued on next page

Pastels and Charcoals, Continued

| | |
|-----------------------------|--|
| Pastels | Pastels are pigment, chalk, and a binder in stick or pencil (wood encased) form. The binder is usually gum tragacanth. Pastel sticks apply broad swatches of color while pastel pencils draw thin, precise lines. You may use pastels as a opaque or semi-opaque medium. Pastels combine easily with other media such as pencil, crayon, and paints to form mixed media images. |
| Degree of softness | Pastels come in soft, hard, or semi-soft sticks and in pencils. The softer the pastel, the more dust produced by heavy strokes. Hard pastels work better on smooth-surfaced paper than softer pastels that require a paper with some tooth. |
| Drawing with pastels | Pastels are a drawing medium capable of producing painterly images. When drawing with pastels, you should have stumps or tortillons, a stiff brush, and soft, hard, and kneaded erasers nearby. The paper you select must have tooth. Hold pastels as you would pencils. Drawings generally proceed from dark to light. Shading and color gradations are made by crosshatching or overstroking pastel strokes until you produce the desired effect. When drawing with oil pastels, use a brush lightly moistened with turpentine for blending. |
| Pastel finishing | At the completion of the drawing, spray over the entire image with fixative. If the drawing loses all highlights, the fixative was too strong and you will have to redraw the highlights. |
| Storing pastels | When storing pastels, separate the drawings with a sheet of acetate. Avoid surface pressure and lateral movement. Although sprayed with a fixative, the surface of a pastel drawing may still rub off and smear. |
| Oil chalk | Oil chalk has the appearance of pastels but, it contains oil. Do not use oil chalk with pastels. The oil binder may leech into the pastel paper leaving a halo of darker paper around the pigment. Use oil chalk with oil-based pigments and impasto. You can also use oil chalk to detail or delineate. Turpentine brushed onto oil chalk will eliminate or blend strokes. |

Continued on next page

Pastels and Charcoals, Continued

Exercises in charcoal and pastel

Pastels and charcoals are drawing mediums with painterly handling characteristics. Practice using charcoal in line drawings. Vary your strokes; overlap and crosshatch for value. Then practice continuous-tone drawings by blending values with a stump and picking out highlights with a kneaded eraser. Practice the above techniques with pastels. Pastels offer the additional challenges of color. Blending colors and values in pastels requires strokes over other strokes. Practice blending pastels.

Figure 1-29 shows charcoal lines possible in vine charcoal.

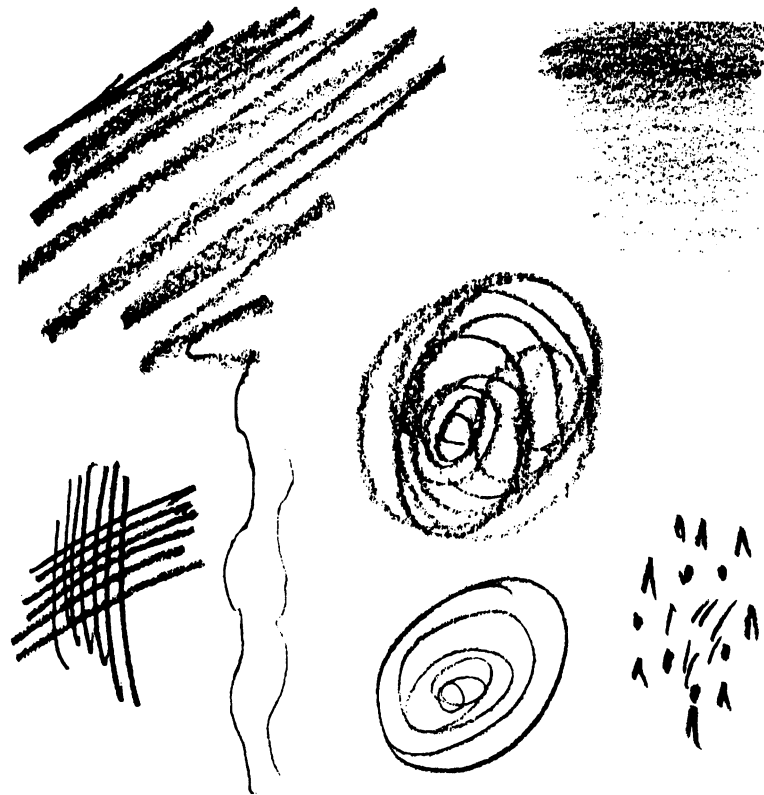

Figure 1-29.—Line variations possible with vine charcoal.

Oil-Based Pigments

Introduction

Painting with oil-based paints has long been regarded as the provenance of traditional or classical fine arts. Oil paint, once difficult to use, required extensive knowledge of chemicals and minerals. Now oil paint is ready to use from the tube and, with specific additives, is easy to apply. For extended study on classic oil painters, review the work of John Singer Sargent and Rosa Bonheur.

Oil-based pigments

Oil-based pigments are pigments ground in an oil base. Oil-based pigments are available in tubes, cans, and pressurized cans. Oil-based pigments in tube form are generally what we know as oil paint. This section on oil-based pigment will also briefly cover lacquer and enamel paints.

Oil paint

Oil paints are pigments ground in linseed oil. The most pure color is attainable straight from the tube. Impressionist painters, obsessed with purity and light, often used paint from the tube without additives. Today, oil painters use additives to extend the pigment, change consistency, and increase or reduce drying time. Oil paint requires a finishing treatment when the painting is complete.

Oil paint extenders

An extender slightly increases the mass of pigment without changing its hue. An extender thins the viscosity of the paint giving it the consistency of melted butter. Use an extender in oil paint when you want to create a glaze or to apply transparent color over the surface of the painting. This technique is referred to as stumbling.

Oil paint impasto

An impasto is a paste or putty additive to oil to create a heavier bodied pigment. An impasto increases the mass and viscosity of pigments without changing its hue. Use an impasto when you want to thickly build up pigment on the painting surface and for textural effects.

Oil paint Reducers

Reducers are chemical additives that reduce the drying time of oil paint. Reducers do not affect hue, but they will thin pigment consistency. The more reducer added to paint, the less time it takes to dry.

Continued on next page

Oil-Based Pigments, Continued

Oil paint opacity and permanence

Oil paints are an opaque medium. You can achieve near transparency or translucence by adding an extender and using the stumbling or glazing techniques. Artist grade oil paint is permanent. Pigments made by organic or mineral derivatives are more permanent than synthetic manufactured color which tends to fade. Without an appropriate ground and substrate, oil paints will crack and flake off the surface of the painting.

Oil paint grounds

The ground and preparation of the substrate is important. An incorrectly prepared surface effects pigment adhesion and permanence. The most common grounds are artist's flake white, artist's white lead in oil, or gesso. Household or industrial white paint is not suitable as a ground because this paint loses its elasticity over time and increases the likelihood of cracking and flaking. You should not apply a ground too thickly. It is better to apply two thin coats. The ground should not ooze out the back of the canvas through the linen mesh.

Substrates

Substrates or the surface on which you apply oil paint are canvas, canvas board, masonite, wood panels, and metal. Before applying a ground to the substrate, seal the substrate with a mixture of rabbitskin glue.

CANVAS: Canvas, bought in rolls, must be attached to stretchers before painting. Once you have secured canvas to a stretcher (a wood frame), make sure to cover the canvas with a mixture of rabbitskin glue and gesso. Be sure to apply the ground to the edges of the canvas where it wraps around the stretcher. This is the first area to deteriorate and it receives the most abuse. Some artists prefer the spring of the canvas under their brush as they paint.

CANVAS BOARD: Canvas board is linen or canvas already adhered to a solid surface such as rigid cardstock or thin wood panels. Many artists prefer canvas board because they do not have to stretch the canvas themselves, and canvas board provides a solid surface on which to paint. The solid backing also offers protection from mishandling and puncture.

Continued on next page

Oil-Based Pigments, Continued

Substrates (Continued)

MASONITE: Masonite is a wood fiber pressed board commonly available in hardware stores. Use untempered masonite. Tempered masonite contains oil providing an unsuitable foundation on which oil-based paints cannot adhere. There are two sides to a masonite board. One side of masonite is smooth and the other side of masonite has a wire mesh texture. Select the side of masonite textured to suit your needs. Large masonite panels may need stretchers to prevent warping and buckling. Size masonite with rabbitskin glue before applying a gesso ground.

WOOD PANELS: Wood panels are surfaces to paint on made from wood. Size and ground wood panel boards as you would masonite.

METAL: Sometimes you may have to paint on metal surfaces. Lightly abrade the surface with a fine grade steel wool before priming. Oil-based pigments painted over metal will take longer to dry than over canvas or wood.

Lacquer-based pigment

Lacquer-based paints are paints suspended in lacquer solvent. They are common paints available as household or shipboard cans and pressurized cans of paint. If the only paint available is lacquer-based paint, be sure to clean your brushes immediately after use with lacquer thinner or mineral spirits. Remove the solvent residue by washing brushes in mild soap and water.

Enamel-based pigment

Enamel-based paints are also common household or shipboard paints. Enamel paints are available in cans and pressurized cans. If enamel-based paints are the only paint available to you, be sure to thoroughly clean the brushes in mineral spirits before washing them in mild soap and water.

Lacquer-and enamel-based pigments

If you must use lacquer- and enamel-based pigments on the same project, do not apply lacquer-based paint over an enamel paint. The lacquer-based paint curdles enamel-based paint and may immediately peel it from the substrate.

Continued on next page

Oil-Based Pigments, Continued

Painting with oil paints

The four ways of painting in oil paints are referred to as underpainting, overpainting, alla prima painting, and improvised painting.

Underpainting

Underpainting is the technique of painting multiple thin coats of paint before painting (overpainting) the final layer of paint. Oil paints used for underpainting should contain less oil than paint used for top layers. Underpainting may be classified as toned ground, grisaille, underpainting in light color, underpainting in dark color, and underpainting in contrasting colors.

TONED GROUND: Underpainting a toned ground in a middle-toned value is simply painting a colored canvas.

GRISAILLE: Underpainting in grey or a mottled grey is called grisaille and is most often used as a background in portraiture.

UNDERPAINTING IN LIGHT COLOR: Use light color as a base coat and accent with a purer or dark color to produce luminous effects.

UNDERPAINTING IN DARK COLOR: Use dark color as a foundation when you intend to apply a lighter color for effect.

UNDERPAINTING IN CONTRASTING COLOR: To underpaint in contrasting colors is to first paint a layer of chosen pigment and apply a contrasting color over it. This technique enhances the impact of colors, but is difficult to control.

Overpainting

Overpainting is the technique of painting the final layers of paint. Stumbling and glazing are overpainting techniques.

SCUMBLING: Stumbling is a form of overpainting that requires a light oil paint reduced to a translucent pigment. The translucent pigment is then painted over an already dark painted layer of underpainting. The more contrast in tonal value between the two layers, the more dramatic the effect.

GLAZING: Glazing is the opposite of scumbling, although it also requires reducing oil paint to a transparent pigment. You apply a dark pigment over a layer of light underpainting to leave a transparent film.

Continued on next page

Oil-Based Pigments, Continued

Alla prima

Alla prima painting is a technique in which the painting is started and finished in one sitting. Only the finishing step is applied later after the painting dries.

Improvised painting

A technique in which there is no structure or preplanning of images and paint application is called improvised painting.

Special equipment

Special equipment used to create special effects consists of scraping tools, paper towels or sponges, and toothbrushes. Tools you chose to create special effects is limited only by your imagination.

SCRAPING TOOLS: Scraping tools remove pigment from canvas. A scraping tool leaves a distinct mark and can expose the linen texture of the canvas. Scraping tools include palette knives, razor blades, pins, nails, saw blades-any object that will remove the pigment.

PAPER TOWELS and SPONGES: Paper towels and sponges push pigment around on the canvas surface imparting their own imprint to the paint.

TOOTHBRUSHES: Toothbrushes or any stiff bristled brush will texture paint when you stab or drag the bristles through the pigment.

Oil paint storage

When painting in oil paint, you can save excess paint left on the palette between painting sessions by immersing the palette in clean, cool water. Water does not dilute or affect oil-based paints.

Finishing techniques

Most oil paints require an over coat of thin, soft varnish or shellac. You may apply varnish or shellac as a matte or gloss surface treatment. Make sure the painting is thoroughly dry before applying a finish coat. If you do not, moisture trapped under the finish medium hazes or forms white clouds. This aberration is known as bloom.

Exercises in oil paint

Practice handling oil-based paints with a brush. Load the brush with the pigment. Palette the brush to position the pigment. Blend colors and values. Develop a thorough, methodical procedure for painting.

Acrylic-Based Pigments

Introduction

Some artists consider acrylic-based pigment a water-based medium because when wet, the pigment is water soluble. But, acrylic-based pigments are not a pure water medium. Acrylic-based pigments have synthetic properties that alter their consistency, permanency, and application. For extended study of acrylic-based painting, study contemporary works from artists such as Georgia O'Keefe and Helen Frankenthaler.

Acrylic-based pigments

Acrylic-based pigments are pigments mixed with a synthetic binder of acrylic resin emulsified in water or turpentine. Acrylic resin is a plasticizer that gives acrylic paints elasticity and endurance. Acrylic-based pigments have gained tremendous popularity since their introduction in the 1960s because of their ease in handling, clean up, color intensity and choice. You will most often encounter acrylic paint with a water base.

Acrylic paint

Acrylic paints are pigment and powdered acrylic resin emulsified in water. Acrylic paint is water soluble when wet and waterproof when dry. Acrylics dry quickly. Acrylic color is brilliant with strong covering power; however, it sometimes stains. You can use additives to extend the pigment, change consistency, and increase drying time.

Acrylic paint extenders

An extender for acrylic paint is called an acrylic gel medium or acrylic polymer emulsion. The extender has a milky white appearance that disappears when dry leaving a gloss or matt finish to the pigment. Combing gloss and matt extenders yields a semigloss finish. You can add water to acrylic paint even after adding an extender. Expect the drying time for the paint to increase.

Acrylic paint impasto

An impasto is a thick mass of acrylic modeling paste, marble dust, and filler. By mixing impasto with acrylic paint, you can add surface texture to your painting. Impasto has the consistency of paste or dough and dries slowly. The outside skin dries faster than the inside creating large cracks that may require filling. When painting with impasto, use a substrate with a rigid backing.

Continued on next page

Acrylic-Based Pigments, Continued

Acrylic paint permanence and opacity

Artist grade acrylic paint is permanent. You can thin acrylic paint with water but, overthinning causes the pigment to separate lessening its permanence. Once it is dry, you can clean the surface of an acrylic painting with mild soap and water. Wiping the surface of an acrylic painting with cleaners containing petroleum or coal tar derivatives may soften or dissolve the paint.

Acrylic paint grounds

You do not require ground or surface preparation when painting in acrylic paint because of the outstanding adhesive quality of the binder. There is an acrylic gesso available for painters who prefer to paint over a ground. This gesso is very smooth and may be used under oil paintings to provide a foundation with some elasticity. You will not be able to paint with acrylic paint over an oil-based or oily foundation.

Substrates

Substrates or the surface on which you apply acrylic paints may be canvas, canvas board, masonite, wood panels, and metal. You may also apply acrylic paints to paper products and fiber cloth. No sizing or ground is required. When using an impasto, paint on a rigid backed, nonabsorbent substrate.

Painting in acrylic paints

Acrylic paints have the consistency of oil paint and the application characteristics of watercolor. Acrylics dry fast so you can build up successive washes quickly. You may apply transparent or semitransparent glazes over solid values. Use a wet or dry brush blending technique to blend acrylics.

Continued on next page

Acrylic-Based Pigments, Continued

Special equipment

Special equipment to create special effects may consist of scraping tools, paper towels or sponges, and toothbrushes or mouth atomizers.

SCRAPING TOOLS: Scraping tools remove pigment. Scraping tools leave distinct marks and can expose the linen texture of canvas or the weave of paper. Scraping tools include palette knives, razor blades, pins, nails, and saw blades. You can use any object to scrap away paint from a substrate providing you do not damage the surface of the substrate.

PAPER TOWELS and SPONGES: Paper towels and sponges push pigment around and leave an imprint in the remaining pigment.

TOOTHBRUSHES and ATOMIZERS: Toothbrushes or stiff bristled brushes and atomizers leave a splattered or mottled effect on the painting surface.

Acrylic paint storage

Prepare sufficient acrylic paint for one painting session. Acrylic paints dry too quickly to leave for any period of time.

Acrylic finishing

An acrylic painting does not require a finish coat of varnish or shellac but, a finish coat will provide some measure of protection and even out irregular surface reflections. If you want to apply a finish coat to an acrylic painting, use an acrylic medium in gloss, semigloss, or matt. Do not use a petroleum-based acrylic varnish because petroleum derivatives may discolor and soften acrylic paint.

Exercises in acrylic paints

Painters in acrylic should frequently exercise painting techniques. Acrylic paint is not only one of the most versatile mediums but also one of the trickiest. Try underpainting and overpainting in acrylics. Paint a flat and graded wash. Practice wet and dry brush blending techniques. Learn to feel the difference in texture and surface effects between oils and acrylics.

Water-Based Pigments

Introduction

Water-based pigments can be difficult to master, but they provide a solid foundation in technique that translates easily into other media. You cannot hide your mistakes in water media. For this reason, beginning painters should start with watercolor and progress through the other water media of gouache, casein, and eventually acrylics. For extended study in watercolor, review the works of Emil Nolde and Charles Demuth.

Water-based pigments

Water-based pigments or water media are pigments combined with a binder and diluted with water. You should use distilled water to dilute water-based pigments before application. Tap or impure water effects the clarity and permanence of water-based pigments.

Watercolors

Watercolors are pigments combined with gum arabic and diluted with water before application. Watercolors are available as powder, pan cakes, and tubes. Watercolors in powder or pancake form may require additional preparation before use such as grinding and mixing with a binder. Watercolor in a tube is ready to use. Tube color and some pan cakes are mixed with glycerin to retain moistness. Watercolors are water soluble when wet and dry.

Watercolor permanence

Watercolor pigments are classified by degrees of permanence based on research. Select a degree of permanence to suit your needs.

Permanence is designated according to this table:

| Designator | Meaning |
|------------|--|
| AA | A permanent, artist-grade quality paint. |
| A | A somewhat permanent, student-grade pigment. |
| B | A moderately permanent, cheaper, lower quality paint good for preliminary studies. |
| C | No significant degree of permanence, intended primarily for general public or classroom use. |

Continued on next page

Water-Based Pigments, Continued

Watercolor characteristics

Watercolor is a transparent medium. Light reflects through the pigment from the paper surface. Watercolors look lighter when dry than wet, so mix pigments darker than required. You may also use watercolor as a translucent or as an opaque. Watercolor applied in thick layers creates cracks and is slow to dry. Painting layer over layer will muddy clarity. If you intend to paint one wash over another, allow the first wash to dry thoroughly before applying the second. Apply the second wash lightly and rapidly over the first to prevent picking up the pigment in the first wash.

Watercolor storage

Mixed watercolors may be kept in jars or in an enclosed palette with a damp sponge or paper towel inside to keep in moisture.

Figure 1-30 shows a palette with deep wells and a cover designed to keep pigments damp.

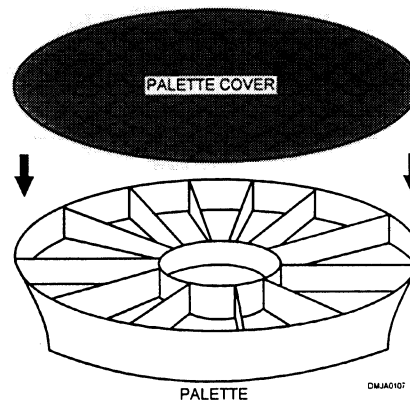

Figure 1-30.—A covered palette.

Watercolor finishing techniques

Watercolors have a matte surface. Watercolors do not require any special finishing techniques.

Gouache

Gouache is a form of opaque water media. Gouache may be dye or pigment, white paint and/or precipitated chalk suspended in a binder of gum arabic and diluted with water. When diluted and packaged in jars or tubes, it is also called tempura, show card color, or designer color.

Continued on next page

Water-Based Pigments, Continued

Gouache
permanence

Gouache is classified by degree of permanence, opacity, and staining properties based on tests and research. Select a degree of permanence that suits your needs.

Permanence is designated according to this table:

| Designator | Meaning |
|-------------------|---|
| A | A permanent artist-grade pigment. |
| B | A moderately permanent, student-grade pigment. |
| C | Nonpermanent pigment for general public or classroom use. |

Opacity is designated according to this table:

| Designator | Meaning |
|-------------------|------------------------|
| O | Opaque. |
| R | Reasonably opaque. |
| P | Partially transparent. |
| T | Transparent. |

Staining properties are designated according to this table:

| Designator | Meaning |
|-------------------|--|
| N | Nonstaining and safe to wash over. |
| M | Moderately safe but, some dyes may bleed into an overwash. |
| S | Staining |
| SS | Strongly staining. |

Continued on next page

Water-Based Pigments, Continued

Gouache characteristics

Gouache is opaque and chalky in appearance. Gouache should be applied in thin layers; otherwise, thick layers may become brittle and crack. Gouache is ideal for large areas of solid color and for small detail. Gouache in light colors dries darker than when wet. Gouache in dark colors lighten as it dries.

Gouache storage

You may store the gouache for short periods in an enclosed palette with a moist sponge or paper towel inside if you finish painting and have pigment left over. The moist sponge or paper towel will release moisture in the air allowing longer storage periods.

Gouache finishing

Gouache has a matte surface and does not require any special finishing techniques.

Casein

Casein is a water-based pigment made by combining a milk derived emulsion with oils, a stabilizer, and pigment. The formula for creating casein varies from manufacturer to manufacturer. Therefore, it is wise to select one brand of casein and use it exclusively.

Casein permanence

Casein is a relatively permanent pigment that is not rated by degrees of permanence. Casein is centuries old with only recent emulsion refinements.

Casein characteristics

Casein is not fluid like watercolor and gouache and not flexible like acrylics. Casein is water soluble when wet but, water proof when thoroughly dry. Casein is opaque with some amount of white added to each color. Casein is brittle and will crack when applied in thick layers.

Casein storage

Casein does not store well. Cheaper brands of casein lacking sufficient fungicides and stabilizers tend to mold and decompose. You should prepare the amount of casein you expect to use in one sitting. Clean your brush often during a painting session. Scrape excess paint from the palette and thoroughly clean the palette before putting it away.

Continued on next page

Water-Based Pigments, Continued

Casein finishing Paintings painted in casein have a matte or semi-matte surface finish. To achieve a light gloss on the surface of a casein painting, lightly rub the surface with a clean, dry, soft cotton ball.

Special equipment

Special equipment used to create special effects consists of scraping tools, paper towels or sponges, toothbrushes, atomizers, salt, stencils, or masking fluids. Experiment with each of these tools.

SCRAPING TOOLS: Scraping tools remove pigment from the paper surface after you apply it. Scraping tools leave distinct marks according to the type of tool. Scraping tools include knife blades, razor blades, pins, nails, saw blades, palette knives, and fingernails.

PAPER TOWELS and SPONGES: Paper towels and sponges soak up excess pigment and water leaving images all their own. For an interesting effect, crumple a piece of paper, partially uncrumple it and dab it into the pigment on the paper surface.

TOOTHBRUSHES and MOUTH ATOMIZERS: You can create spackled effects of all intensities with a toothbrush or a mouth atomizer. To use an atomizer, place the straw end into a cup of pigment and blow into the mouthpiece.

Figure 1-31 shows a mouth atomizer.

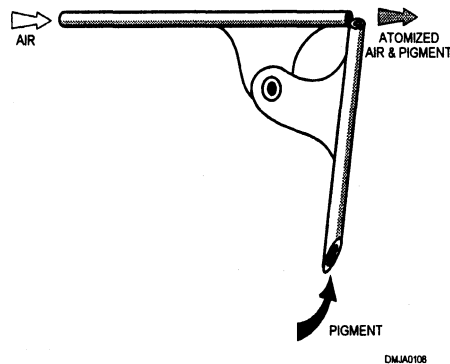

Figure 1-31.—A mouth atomizer.

Continued on next page

Water-Based Pigments, Continued

Special equipment (Continued)

SALT: Salt placed on the wet surface of a watercolor painting will repel pigment around it leaving a white spot difficult to create any other way. This is an especially effective technique for creating snow and sand.

STENCILS: Stencils placed on a painting surface will protect areas from receiving pigment. You can cut the edge of a stencil straight or jagged. For a softer edge, raise the stencil slightly from the paper surface.

MASKING FLUID: Liquid rubber cement or a commercially prepared liquid frisket protects areas you do not want to receive pigment. After the paint dries, the masking fluid can be removed by rubbing gently over the surface of the frisket until it releases or curls away.

Blending techniques

The two blending techniques are the wet-brush and the dry-brush method.

Wet brush blending

Wet brush blending uses water to blend water-based media. Apply the wet brush technique after you finish setting the flat tones on the subject.

To employ the wet brush blending technique, follow this table:

| Step | Action |
|------|--|
| 1 | Set the flat tones of the subject. |
| 2 | Lay both selected values side-by-side, overlapping slightly. |
| 3 | Wet your brush in clear water. |
| 4 | Starting at the top, work your brush back and forth over the area where the values overlap. |
| 5 | Clean the brush and wet it slightly. |
| 6 | With vertical strokes, soften the previous horizontal strokes. Be careful to not lift the paint as you soften the strokes. |

Continued on next page

Water-Based Pigments, Continued

Wet brush blending (Continued)

Figure 1-32 illustrates the wet brush blending technique.

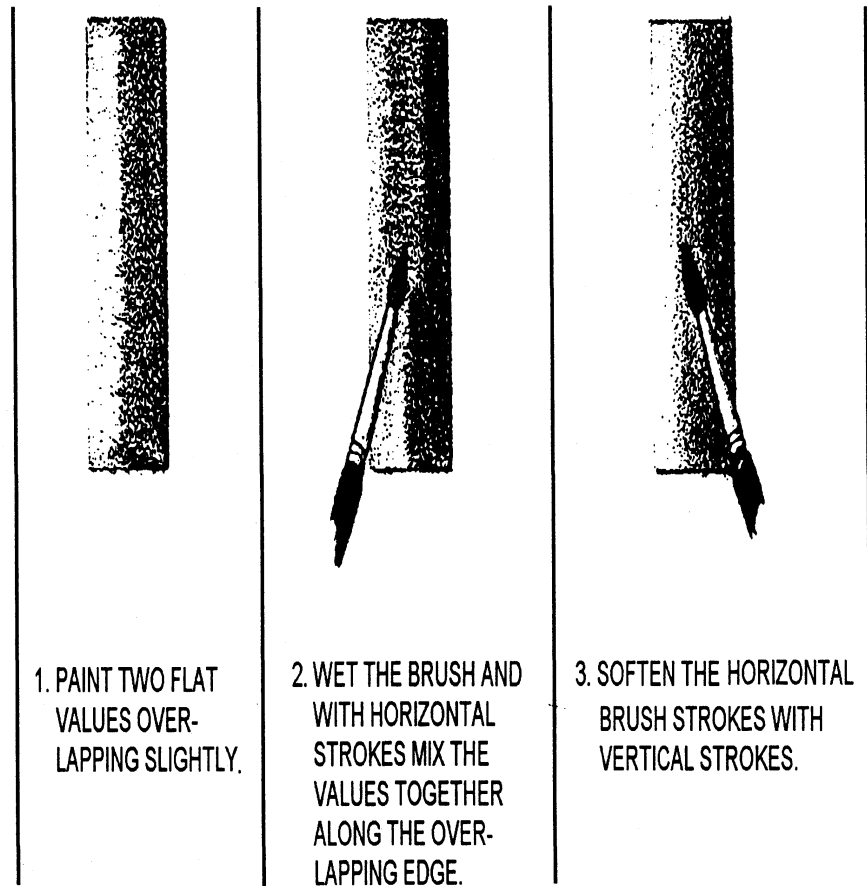

DMJA0109

Figure 1-32.—Wet brush blending.

Continued on next page

Water-Based Pigments, Continued

Dry brush blending

Dry brush blending is another method of blending adjacent values, but this method uses a relatively dry brush.

To employ the dry brush blending technique, follow this table:

| Step | Action |
|-------------|--|
| 1 | Set the flat tones of the subject. |
| 2 | Lay both values side-by-side, overlapping slightly. |
| 3 | Mix a third value halfway between the two values you are blending. |
| 4 | With your brush, pick up a small portion of the third value. |
| 5 | On a scrap sheet of paper, pallet the brush back and forth to remove a majority of the pigment. The brush bristles should be nearly dry with only pigment remaining. |
| 6 | Work the dry bristles over the area where the adjacent values overlap. |
| 7 | Slightly moisten the brush with water and vertically stroke over the previous strokes to soften the edges. |

Continued on next page

Water-Based Pigment, Continued

Dry brush blending (Continued)

Figure 1-33 illustrates the dry brush blending technique.

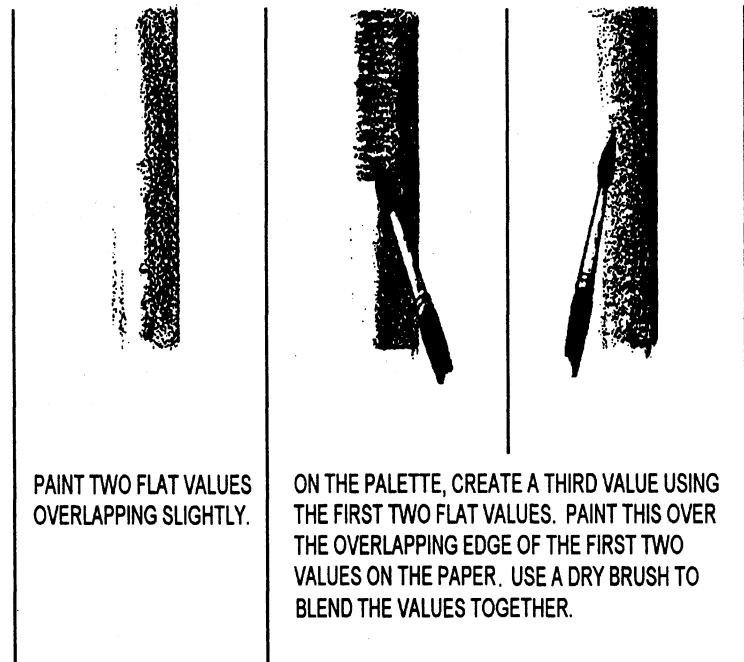

DMJA0110

Figure 1-33.—Dry brush blending.

Exercises in water-based media

Only through practice will you master water-based pigments. But, once you are skilled in water media, mastering oils and acrylics should be easy. Prepare a work area with plenty of clean water and practice grade paper. Practice laying brush strokes of varying widths. Imitate surface texture with your brush. Lay a flat and graded wash. Set similar and widely differing tones side-by-side and develop your technique for wet and dry brush blending.

Summary

Review

This chapter covers the various media a Navy Illustrator Draftsman uses. You should understand the differences in drawing media, paper surfaces, lead hardness, and ink properties. Recognize the differences in oil-, acrylic-, and water-based pigments. Pigments apply, dry, and clean up differently. Pigments that have different bases will behave differently and, in turn, affect their presentation. Practice drawing and painting until you are fluent in the language of visual imagery.

Comments

There is always a market for the traditional skills of painting. You may be asked to paint signs or logos. You may also have to paint a mural. If this service is not asked of you and you are willing and capable, volunteer it. Your customer base will increase tenfold and extend well outside of your immediate command. You may enhance your career by increasing your skills and knowledge of all available media.

CHAPTER 2

COLOR

Overview

Introduction

To use color effectively, you must know what color is, how to organize color, and how to use color advantageously. Light contains all of the colors we see. Therefore, it is also necessary to understand some of the characteristics of light.

Objectives

The material in this chapter enables you to do the following:

- Differentiate among four different color theories and applications.
 - Select a color scheme for high key achromatic illustrations.
 - Assemble three types of palettes.
 - Create effective color combinations.
 - Describe the differences among several color schemes.
 - Prepare color masters for subsequent printing.
 - Recognize the difference between process color and computer-generated color.
-

Continued on next page

Overview, Continued

Acronyms

The following table contains a list of acronyms that you must know to understand the material in this chapter.

| Acronym | Meaning |
|----------------|--------------------------------------|
| bit | Binary Digit |
| CCD | Charge-Coupled Device |
| CEPS | Color Electronic Prepress System |
| CYMK | Cyan, Yellow, Magenta, and Black |
| dpi | Dots Per Inch |
| MAC | Macintosh computer or clone |
| nm | Nanometer |
| PC | Personal Computer (IBM or IBM clone) |
| Pixel | Picture Element |
| PMT | Photomultiplier Tube |
| RAM | Random Access Memory |
| VGA | Video Graphics Array |
| WYSIWYG | What You See Is What You Get |

Continued on next page

Overview, Continued

In this chapter This chapter covers the following topics:

| Topic | See Page |
|-----------------------------------|----------|
| Light | 2-4 |
| Additive Theory of Color | 2-9 |
| Subtractive Theory of Color | 2-10 |
| Process Color | 2-32 |
| Color Electronic Prepress Systems | 2-35 |
| Desktop Color | 2-36 |

Light

Introduction

Without light there would be no vision or color. Light reflected from objects around us makes things visible.

Light

Light is a form of electromagnetic radiant energy visible to the human eye. The visual spectrum, what we see, is only a small part of the entire electromagnetic spectrum.

Figure 2-1 shows the range of the electromagnetic spectrum.

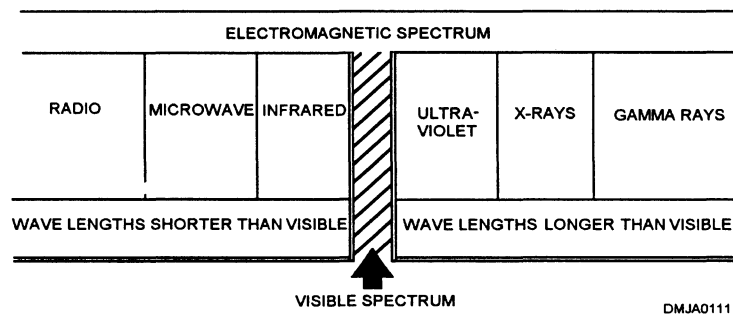

Figure 2-1.—The position of visible light in the electromagnetic spectrum.

White light refracted through a prism reveals the colors that comprise the visible spectrum.

Figure 2-2 shows visible light as refracted through a prism.

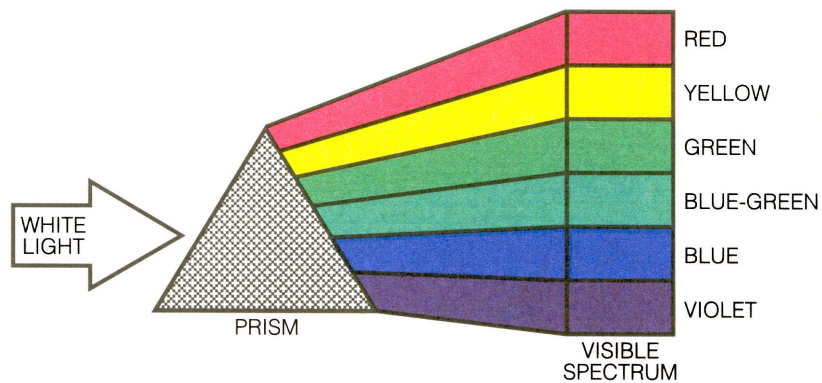

Figure 2-2.—The refraction of light by a prism.

Continued on next page

Light, Continued

Characteristics of light

No one completely understands the nature of light. However, two theories of light are used to explain light characteristics. The two theories of light are referred to as the *quantum theory* and the *wave motion theory*.

QUANTUM THEORY: The quantum theory of light applies to X-ray, radiation, and photoelectricity. This theory states that light is a steady stream of high-speed particles and that all light sources send out a stream of these particles. Each particle of light (quantum) is referred to as a *photon*.

WAVE MOTION THEORY: The wave motion theory of light involves reflection, absorption, transmission, and polarization of light.

Wave motion theory

In the wave motion theory of light, light, wavelength, speed, and frequency are important but interrelated characteristics. The wave motion theory is the theory that affects Illustrator Draftsman the most.

LIGHT: Light stimulates the perception of sight. White light is made of equal intensities of all wavelengths within the visible spectrum. What we see as color is light of a particular wavelength.

WAVELENGTH: Wavelength is the chief determinant of perceived color. A wavelength is defined as the distance from the crest of one wave to the crest of the next wave. Wavelengths are measured in nanometers (nm) which are equal to one millionth of a millimeter. Light travels in a straight line, and when it encounters an object or enters a new medium, say water, it may be reflected, absorbed, or transmitted.

SPEED: The speed of light is constant until it passes through a new medium, such as water, air, or glass. The speed of light is the product of wavelength multiplied by the frequency. Dividing the frequency by the (constant) speed of light results in approximate wavelength.

FREQUENCY: Frequency is the number of wavelengths passing a given point in 1 second.

Continued on next page

Light, Continued

Wave motion theory (Continued)

Figure 2-3 shows the relationship between wavelength and frequency.

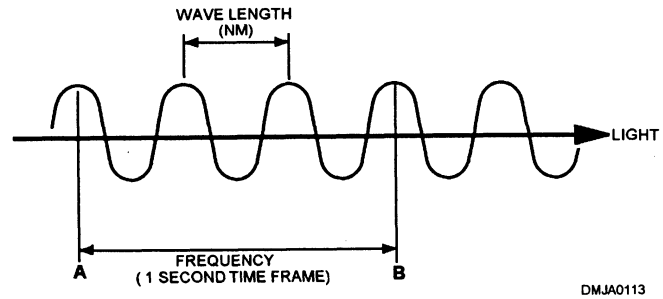

Figure 2-3.—The relationship of wavelength to frequency.

Reflection

Reflection occurs when light that strikes an object bounces off its surface. When a surface is smooth and polished, the reflection is orderly, or specular. Specular light reflects at the same angle to the surface as the incoming light. When a surface is irregular, light reflects irregularly and diffuses reflecting light in different directions. Practically all surfaces reflect both specular and diffused light.

Figure 2-4 illustrates specular and diffused light reflection.

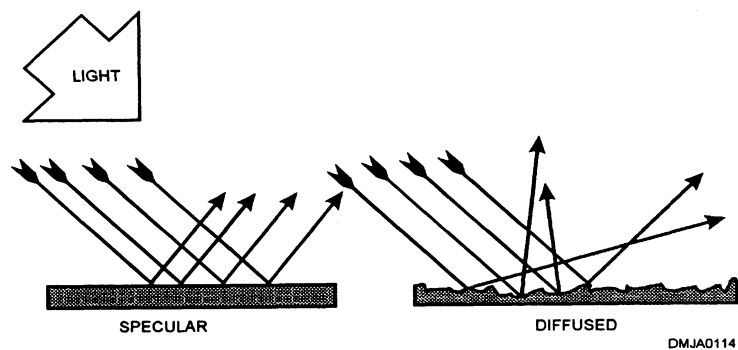

Figure 2-4.—Specular and diffused light reflections.

Continued on next page

Light, Continued

Absorption

Absorption occurs when light strikes a medium and the light neither reflects from nor passes through the medium. The surface of the medium will, to some extent, both reflect and absorb light. How an object absorbs light determines the color of the object. Neutral colors, such as white, black, and various tones or values of grey absorb almost equal proportions of the colors of light. White is highly reflective. Black, no matter how much light falls on it, can never be recorded on film except by contrast.

Transmission

Light rays pass through some media they encounter. When objects are clearly seen through the medium, the medium is said to be transparent. Transparent media transmit light rays in regular or uniform patterns. When the medium transmits light but breaks up the order of the pattern and sends the transmitted rays to different directions, the medium is referred to as translucent. An opaque medium does not allow light to pass through. Refraction is a form of transmission. Refraction is the change in direction that occurs when light rays pass from one transparent substance into another substance of different density.

Figure 2-5 shows the effect of different media on light rays.

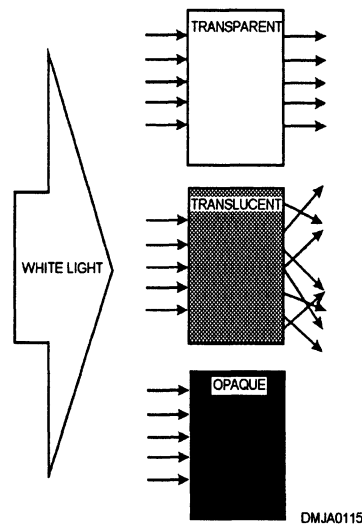

Figure 2-5.—The effect of different densities on light rays.

Continued on next page

Light, Continued

Polarization

Polarized light vibrates in only one direction. Ordinarily, light rays vibrate in all directions at right angles to their direction of travel. When light waves strike a series of parallel microscopic slots, all the light that passes through vibrates in one direction. Filters that polarize light have practical use in photography and in simulating motion on overhead projectors. Specular light reflected from nonmetallic surfaces at any angle between 32° and 37° , is polarized in such a manner that the light rays vibrate in a direction parallel to the reflecting surface. Light reflected in this manner is said to be plane polarized and is seen as glare.

Figure 2-6 shows plane polarization or the characteristics of glare.

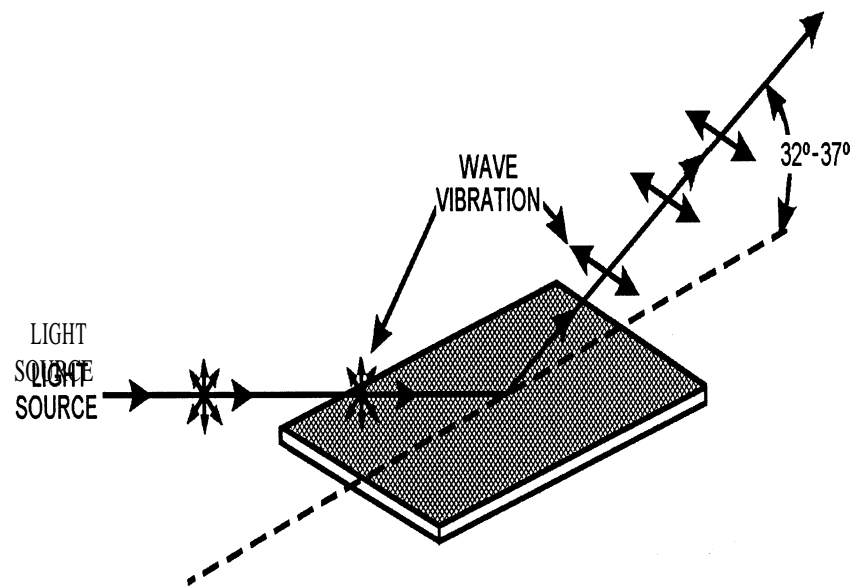

DMJA0116

Figure 2-6.—Plane polarization or glare.

Additive Theory of Color

Introduction

Photography, computer monitors, and television use light to project the colors of the visual spectrum. This technology uses the additive theory of color.

The additive theory of color

The additive theory of color theorizes that white light contains all colors in the visual spectrum. The primary colors of the additive theory of color are red, blue, and green. These colors are called primaries because they cannot be produced by combining any other color. Combinations of the primary colors produce other colors. A combination of the three spectral (additive) primaries produces white light.

Figure 2-7 shows the spectral primaries of the additive theory of color.

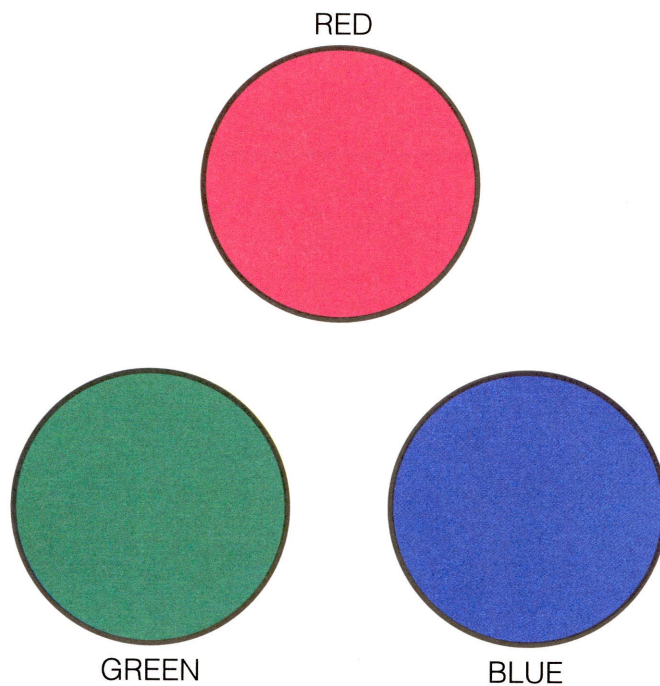

Figure 2-7.—Spectral primaries of the additive theory of color.

Subtractive Theory of Color

Introduction Illustrators and painters use pigments to produce color and color combinations. This is known as the subtractive theory of color.

Subtractive theory of color In the subtractive theory of color, color is produced by pigment or combinations of pigment. The three primary colors of the subtractive theory of color are red, yellow, and blue. Combining any two primaries produces secondary, and combining a secondary and a primary color produces a tertiary color. Combining all three primaries results in a grey or muddy brown mixture.

Primary colors The primary colors in the subtractive theory of color are red, yellow, and blue. These colors are called primary because they cannot be produced by combining any other color. They are the basis on which all other colors are created.

Figure 2-8 shows the primary colors of the subtractive theory of color.

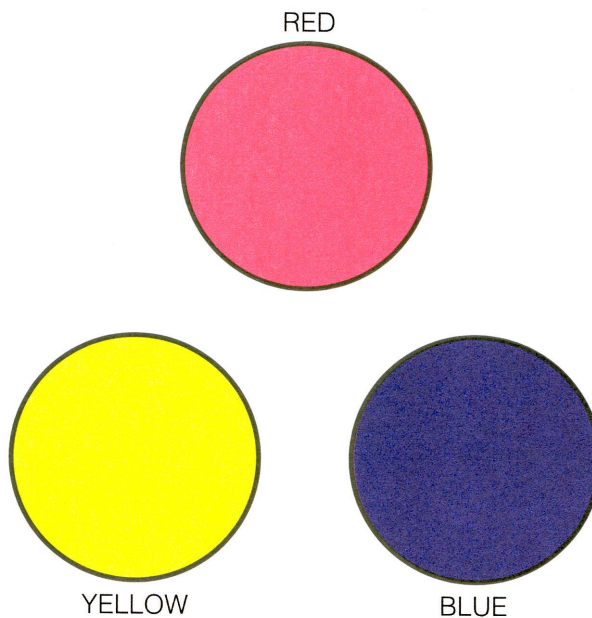

Figure 2-8.—Primary colors of the subtractive theory of color.

Continued on next page

Subtractive Theory of Color, Continued

Secondary colors

Secondary colors are colors produced by combining two of the primary colors in equal amounts. The secondary colors, also called binary colors, are violet, green, and orange. Primary and secondary colors are fundamental colors in the subtractive theory of color.

Figure 2-9 shows the secondary (binary) colors of the subtractive theory of color.

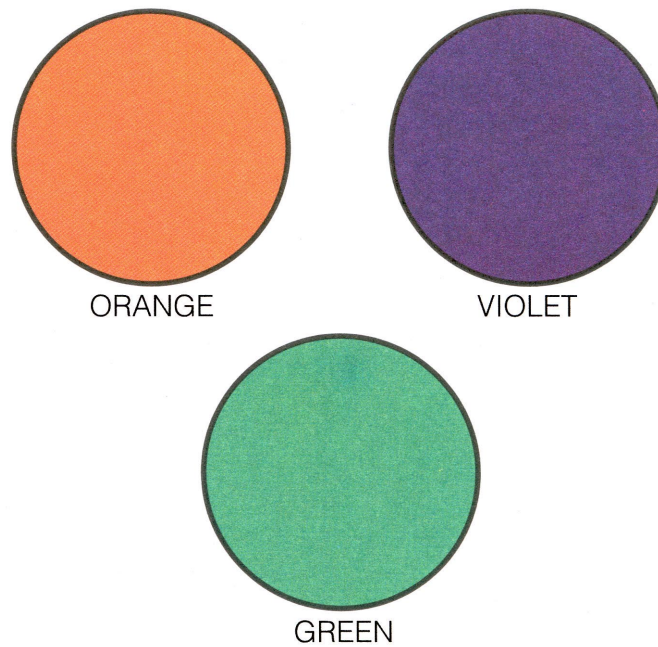

Figure 2-9.—Secondary (binary) colors of the subtractive theory of color.

Continued on next page

Subtractive Theory of Color, Continued

Tertiary colors Tertiary colors are combinations of primary and secondary colors. There are six tertiary colors; red-orange, yellow-orange, yellow-green, blue-green, blue-violet, and red-violet. In compounding these names, such as “red” with “orange” to make “red-orange,” place the primary name first to indicate an excess of the primary over the other color.

Figure 2-10 shows tertiary colors.

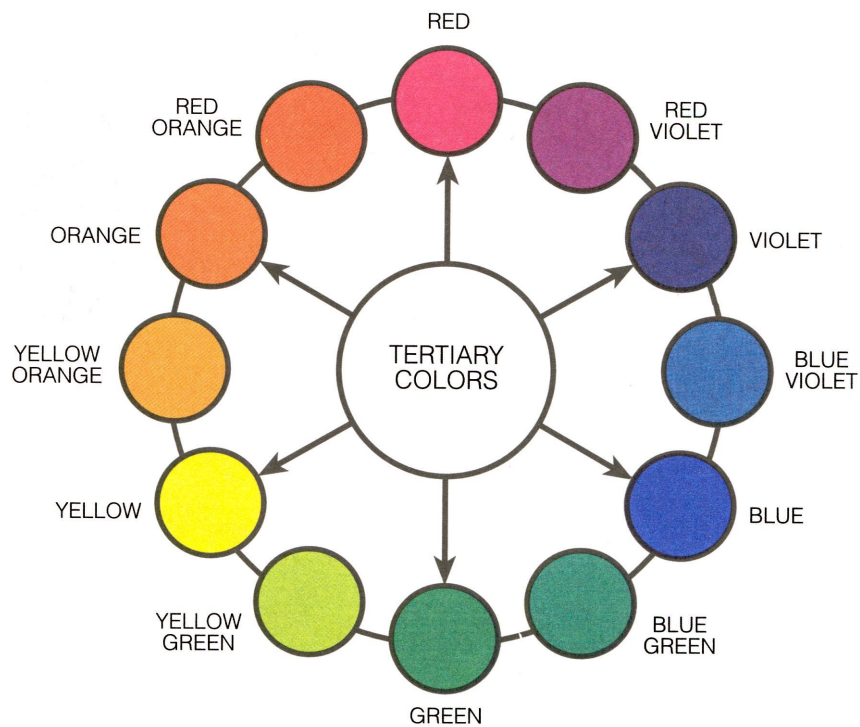

Figure 2-10.—Tertiary colors.

Continued on next page

Subtractive Theory of Color, Continued

Color wheel

A color wheel is a scale for measuring color. A fundamental color wheel displays primary and secondary colors. A 12-pigment color wheel accommodates the primary, secondary, and tertiary colors.

Figure 2-11 shows a fundamental color wheel.

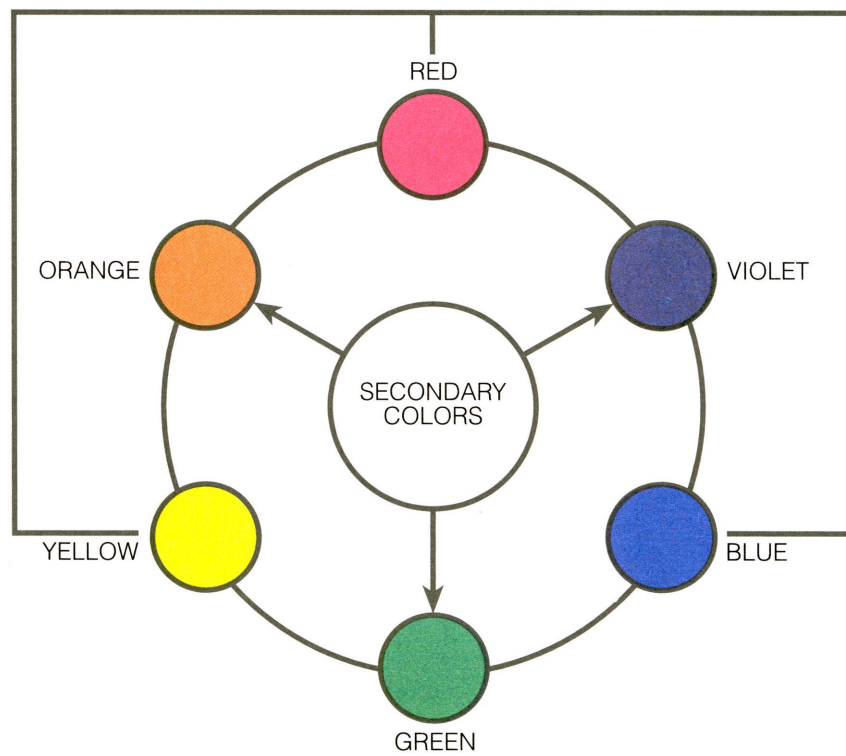

Figure 2-11.—A fundamental color wheel showing primary and secondary (binary) colors.

Continued on next page

Subtractive Theory of Color, Continued

Color Wheel (Continued)

Figure 2-12 shows a color wheel with the primary, secondary, and tertiary colors.

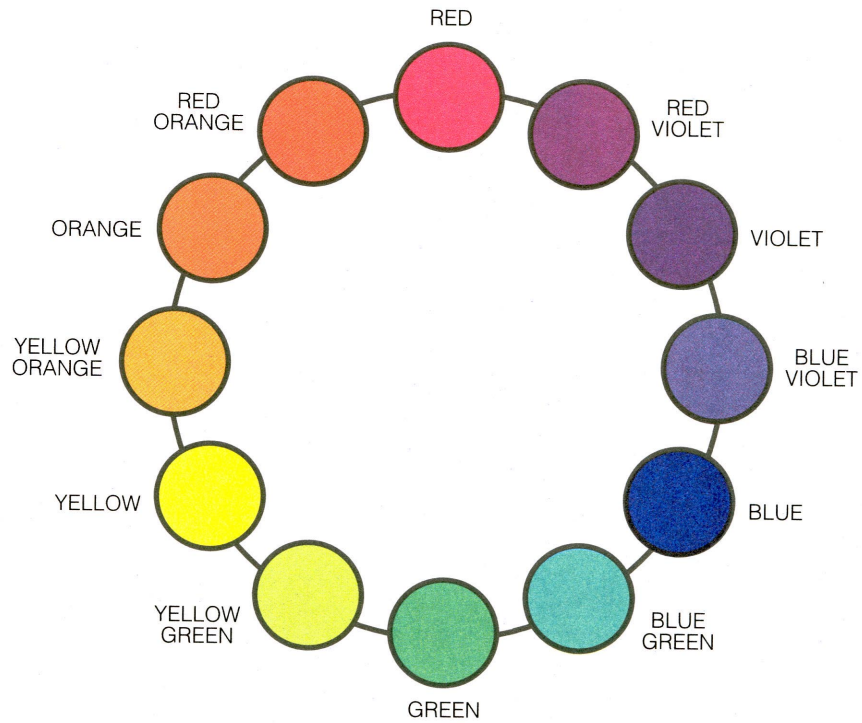

Figure 2-12.—A 12-hue color wheel.

Continued on next page

Subtractive Theory of Color, Continued

Proximity on the color wheel

A look at a 12-color color wheel easily identifies harmonious color combinations and complimentary colors.

Harmonious color

Harmonious colors are colors containing some part of the colors positioned next to them on the color wheel. Harmonious colors lie near each other on the color wheel. Although harmoniously colored images are generally pleasing to the eye, they can become monotonous.

Complimentary color

Complimentary colors lie directly across from each other on the color wheel. The compliment of red is green, of yellow is violet, and of blue is orange. Notice that the compliment of a primary color is a secondary color directly across from it on the color wheel. Complimentary colors are not related, but you can use them to create sharp contrasts or mix them to form a neutral grey.

Dimensions of color

The three dimensions of color are hue, value, and intensity. As an Illustrator Draftsman, you must understand each dimension to successfully analyze and mix colors for your illustrations.

Hue

Hue is the term used to name a color. How light or dark a color may be does not change hue. Hue is color before the addition of any other color.

Figure 2-13 shows light and dark variations-of-a hue.

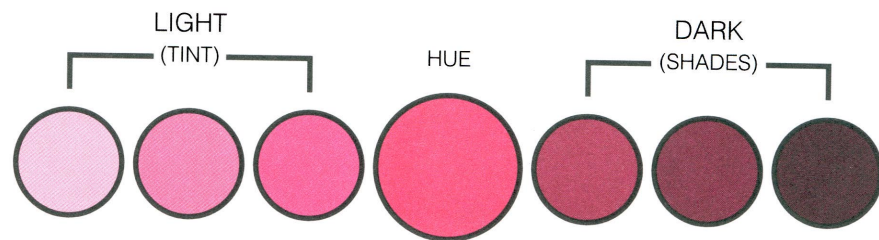

Figure 2-13.—Light and dark variations of the same hue.

Continued on next page

Subtractive Theory of Color, Continued

Value

The second dimension of color is value. Value is the lightness or darkness of a hue. The terms tint and shade refer to the value of a color. You add white to a hue to create a tint. Add black to a hue to create a shade. In neither case has the hue changed, only its value and intensity. You must be able to decide the area that is the lightest and the area that is the darkest. Decide how light or dark an area is to be and relate all other values around this decision. When you decide on a value range or key, be consistent throughout the picture. Low-key value ranges are dark in value and high-key value ranges are bright or lightly colored.

Figure 2-14 shows a value scale or key.

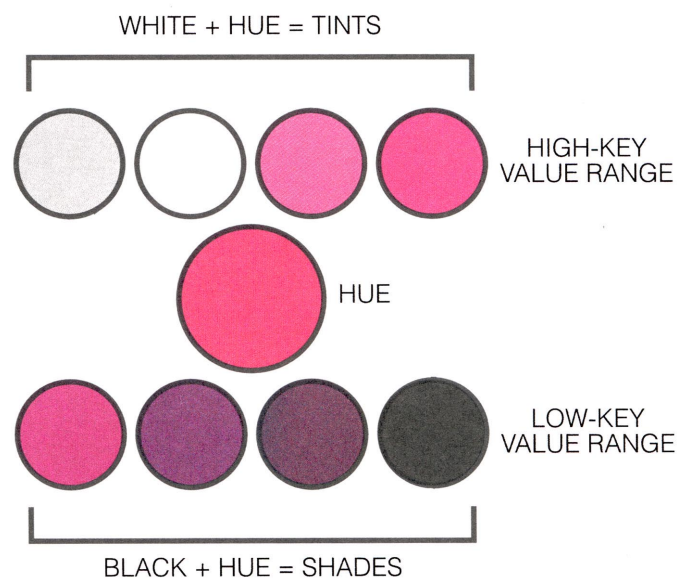

Figure 2-14.—Low and high key value ranges the same hue.

Continued on next page

Subtractive Theory of Color, Continued

Intensity

The third dimension of color is intensity. Intensity, also known as chrome, refers to the degree of strength, saturation, or purity of colors. Pigment squeezed directly from the tube is at maximum intensity. Changing the value of pigment by adding white or black changes intensity but, not hue. You can also reduce the intensity of pigment without changing the value or hue by adding a neutral grey of equal value. Reducing the intensity of pigments by adding their complement changes intensity and hue.

Color schemes

Before you start to paint, make small color thumbnail roughs. Try several color schemes to fit the subject. Use only general shapes and flat tones without detail. Use colors that add interest to your work. Certain color combinations are agreeable while others are offensive. Generally, color schemes will fit achromatic, monochromatic, analogous, complimentary, split complimentary, and triad color patterns.

Achromatic color schemes

Achromatic colors possess no hue. Neutral colors like white, grey, and black are achromatic. These neutral colors are far from being negative because they affect the appearance of other hues. Neutral colors are useful in modifying the values and intensities of all hues.

Figure 2-15 shows an achromatic color scheme.

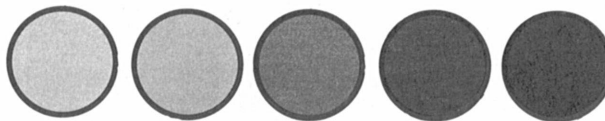

Figure 2-15.—An achromatic color scheme.

Continued on next page

Subtractive Theory of Color, Continued

Monochromatic color schemes The monochromatic color scheme is a single hue used in various tints, shades, and intensities. A monochromatic scheme is harmonious although there is nothing to which a monochromatic color scheme can disagree. One color having values ranging from light tints to dark shades can be colorful.

Figure 2-16 shows a monochromatic color scheme in blue.

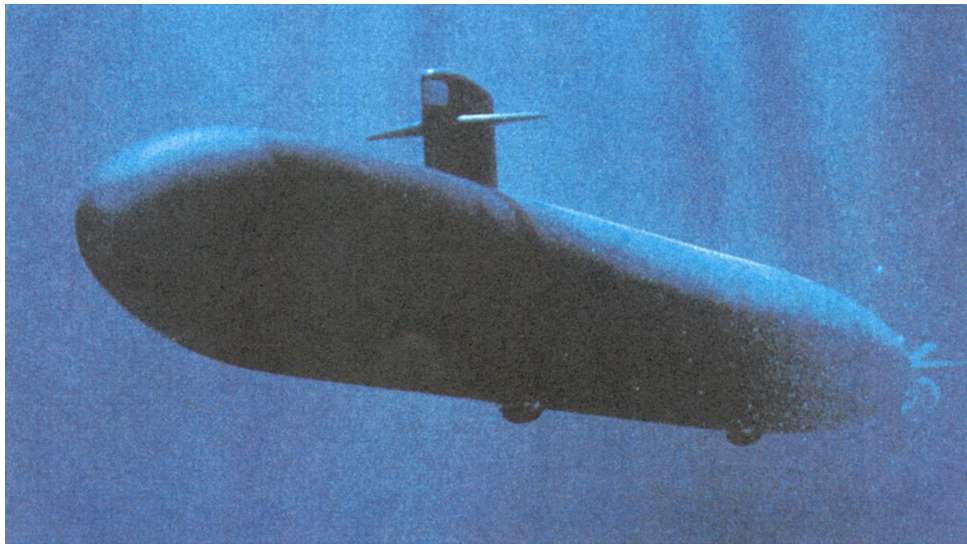

Figure 2-16.—Monochromatic color.

Continued on next page

Subtractive Theory of Color, Continued

Analogous color schemes

An analogous, or related, color scheme is made of hues near each other on the color wheel. They have a common denominator in one color. Out of the 12 hues on a basic color wheel, seven are related through one color. A typical analogous color scheme should not contain more than three or four colors or you jeopardize harmony. Although analogous color schemes are easy to compose, they may become monotonous. Use a variety of values, intensities, and arrangements to develop interest. One of the easiest ways to obtain interest in analogous color schemes is to place emphasis on a dominant hue. Some ways to make a particular hue dominant is to give it a large area, a darker value, or make it the most intense color. Avoid placing equally bright colors next to each other by adding small amounts of one color to the others. Another way to obtain interest in analogous color schemes is to introduce complimentary accents.

Figure 2-17 shows the analogous relationship of colors on a color wheel.

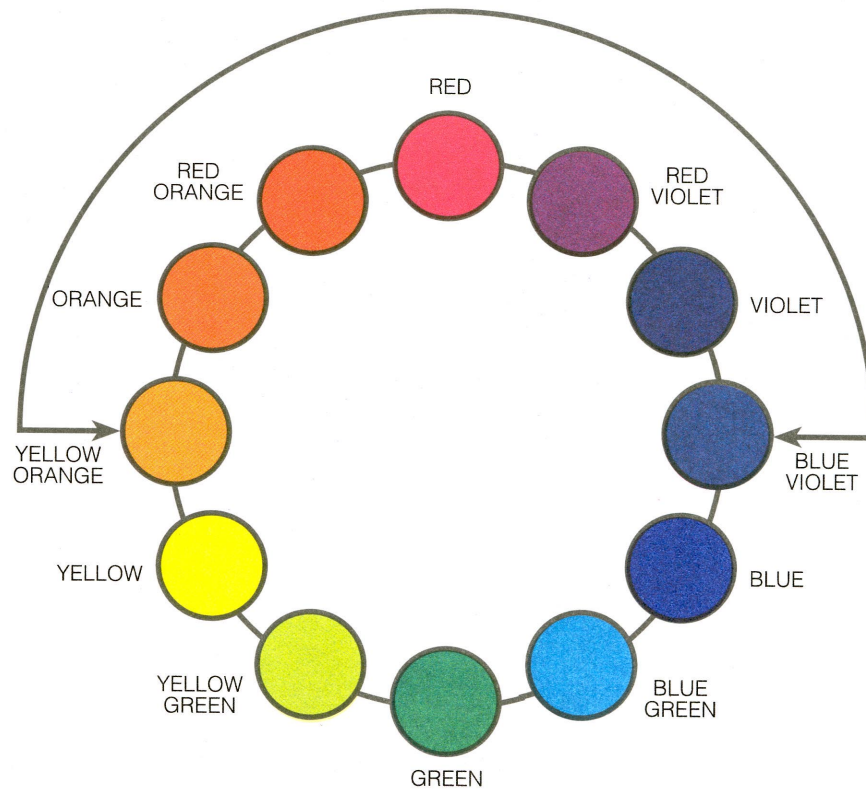

Figure 2-17.—Analogous color.

Continued on next page

Subtractive Theory of Color, Continued

Complimentary color schemes

Complimentary color schemes, sometimes known as harmonies of contrast, conspicuously introduce opposite colors on the color wheel. Complimentary color schemes peak interest but, equal amounts of complimentary colors distract instead of focus. To maintain harmony in complimentary color schemes, use unequal areas, neutralize one color with another, place the primary color as the center of interest and the compliment for the background, contrast light values against dark values, or place dull colors against bright colors. This will give variety to color schemes and create interest.

Figure 2-18 is an effective complimentary color scheme using the compliments of orange and blue.

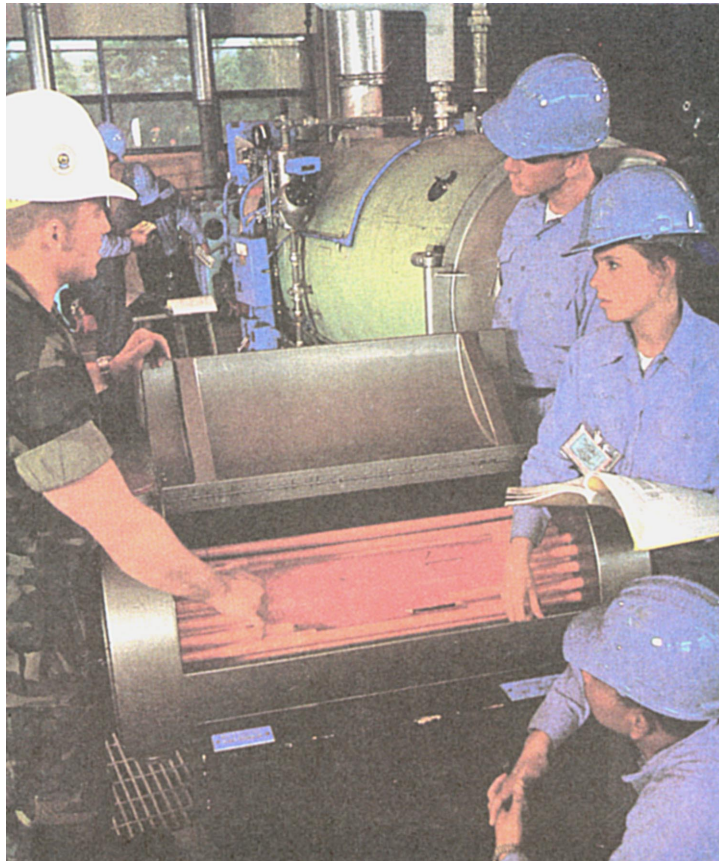

Figure 2-18.—A complimentary color scheme.

Continued on next page

Subtractive Theory of Color, Continued

Split compliment color schemes

Split compliments are colors on either side and exclusive of the true compliment. They are approximate compliments. Split compliment color schemes 'appear more pleasing than complimentary color schemes. If you base color schemes on a color and its split compliments or on hues mixed from them, you have a wide range of hues. None of these hues will be brighter than the color itself and the split compliments in their full intensity. If you find this range of hues limiting, select the next removed set of split compliments.

Triad color schemes

Triad color schemes use three colors equally spaced on the color wheel. Triad color schemes do not guarantee harmony. Using the three primary colors in a triad color scheme is discordant for each color competes for viewer attention. To create harmony in triad color schemes, select one hue as dominant and mix a little of it with the other two.

Figure 2-19 is a photograph displaying a triad color scheme with red dominant and mixed with the other two colors.

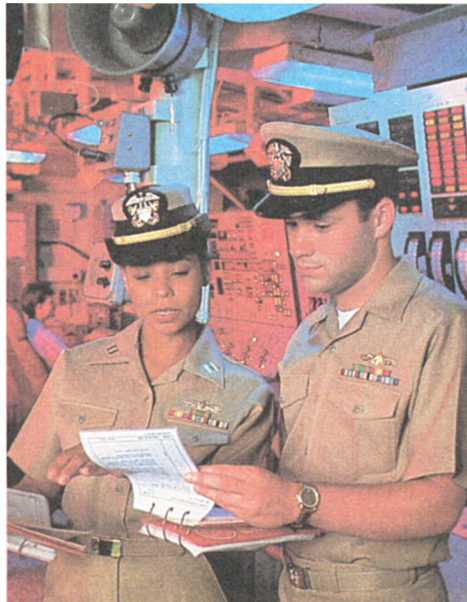

Figure 2-19.—Triadic harmony.

Continued on next page

Subtractive Theory of Color, Continued

Set palette

A set palette is a collection of pigments to which a small amount of one color or grey has been added to each one. The advantage of this is to achieve color harmony and unity. It also restricts the beginning painter to a predetermined set of colors. Adding greys or one dominant hue to all other colors will have the greatest effect on the complimentary of the added color. Adding one color to light areas and one color to dark areas will also create harmony and unity. When you want to emphasize one color in a picture, add the same color to all other colors except the color you want to emphasize.

Color characteristics

Color is said to have warm or cool characteristics. Warm and cool colors are qualities of hue rather than value or intensity. Our experiences and how we feel about certain colors determine their perceived temperature characteristics. You may use the warmth or coolness of colors to suggest the location of an object or to give pictures a striking contrast. Any hue may be cooled by adding blue or warmed by adding yellow. To add realism to pictures, paint the planes receiving direct sunlight with warm colors and the shadow planes with cool colors. Look at a color wheel. Note that it is split nearly in half by hues containing reds, oranges, and yellows associated with heat, flame, or sunshine. The other half of the color wheel contains greens, blues, and violets, which relate to water, sky, and ice.

Figure 2-20 illustrates how a 12-hue color wheel is split between colors with warm and cool characteristics.

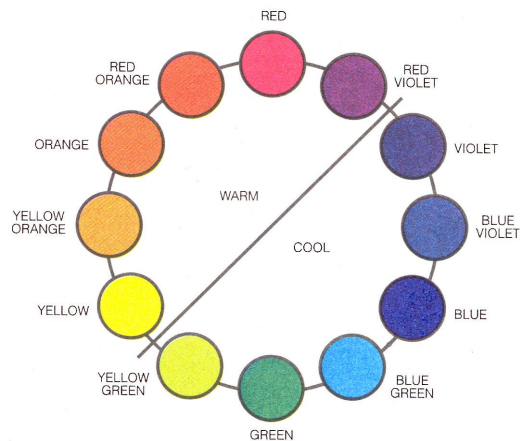

Figure 2-20.—Warm and cool characteristics.

Continued on next page

Subtractive Theory of Color, Continued

Color influence Three factors affect hue, value, and intensity when you see a colored object. These three factors are (1) the local color of the object, (2) the light source which illuminates it, and (3) any color reflecting surfaces near the object. By understanding what happens to color when influenced by other colors, you can use pigments to more effectively portray natural color.

Local color Local color is the color of an object that is not modified by light, reflection, weather, or distance. Local color is sometimes referred to as true color. Even the spot of color in figure 2-21 reflects some light that creates highlights.

Figure 2-21 is a spot of color.



Figure 2-21.—A spot of color.

Continued on next page

Subtractive Theory of Color, Continued

Illumination

The light source that illuminates an object affects the local color of that object. The cool light of northern exposures, early morning, or dusk tends to cool local color. The intense heat of high noon or direct sunlight warms local color.

Figure 2-22 shows the effects of warm and cool illumination on local color.

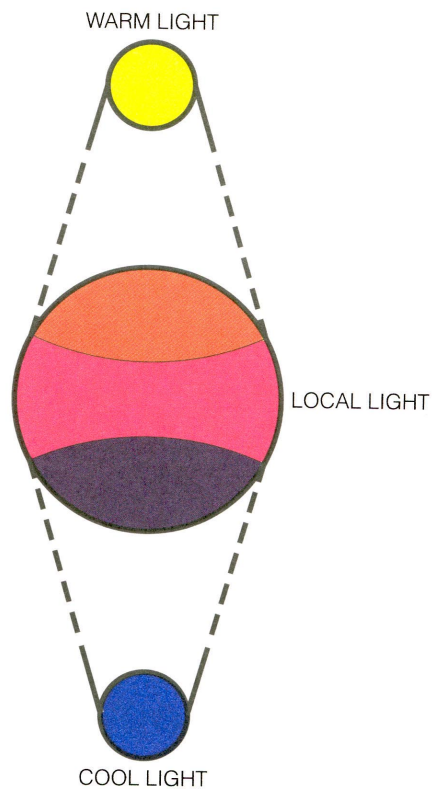

Figure 2-22.—The effects of warm and cool illumination on local color.

Continued on next page

Subtractive Theory of Color, Continued

Adjacency

Adjacency, or color reflecting from pigments or surfaces near the object also affects local color. Colors placed side-by-side will modify each other. Complimentary colors placed side-by-side will seem more intense than if they stood by themselves. Also, intense color will seem brighter and more intense against a greyed color (a color that contains neutral grey or complimentary color) than it will against a color of similar high density. For this reason, do not compare color on your palette. Compare colors as you paint and make adjustments as you work. In the following illustration, notice how reflecting color from the computer monitor affects the faces of the Sailors.

Figure 2-23 illustrates how the reflected color of the computer screen affects the faces of the Sailors.



Figure 2-23.—Adjacency or reflected color warms the faces of these Sailors.

Continued on next page

Subtractive Theory of Color, Continued

Color effects

Color affects the emotions and psychological responses of people. Some generally accepted color-emotion relationships are contained in the following table.

| Color | Emotion |
|------------------|--|
| Dark cool | Strength, restraint |
| Dark warm | Dignity, power |
| Light cool | Freshness, calmness |
| Light warm | Gaiety, excitement |
| Yellow | Warmth, brilliance |
| Red | Gaiety, fear, alarm, warmth, anger, excitement |
| Orange | Sparkle, warmth, autumn |
| Blue | Quietness, serenity, coolness, joy, emptiness |
| Green | Rest, freshness, safety, summer |
| Violet and black | Sadness, mystery, grief, suspense, disgust |

Continued on next page

Subtractive Theory of Color, Continued

Distance

Distance, usually called aerial perspective or color perspective, uses colors to simulate distance and depth in pictures. To create the impression of depth in pictures, reduce the intensity and warmth of colors as they recede into the horizon. Warm colors appear nearer to the viewer than cool colors. Another method to imply distance is to grey or reduce the intensity of colors as they recede.

Figure 2-24 shows how colors of reduced intensity, also colors warmed by yellow, create a sense of depth and distance.

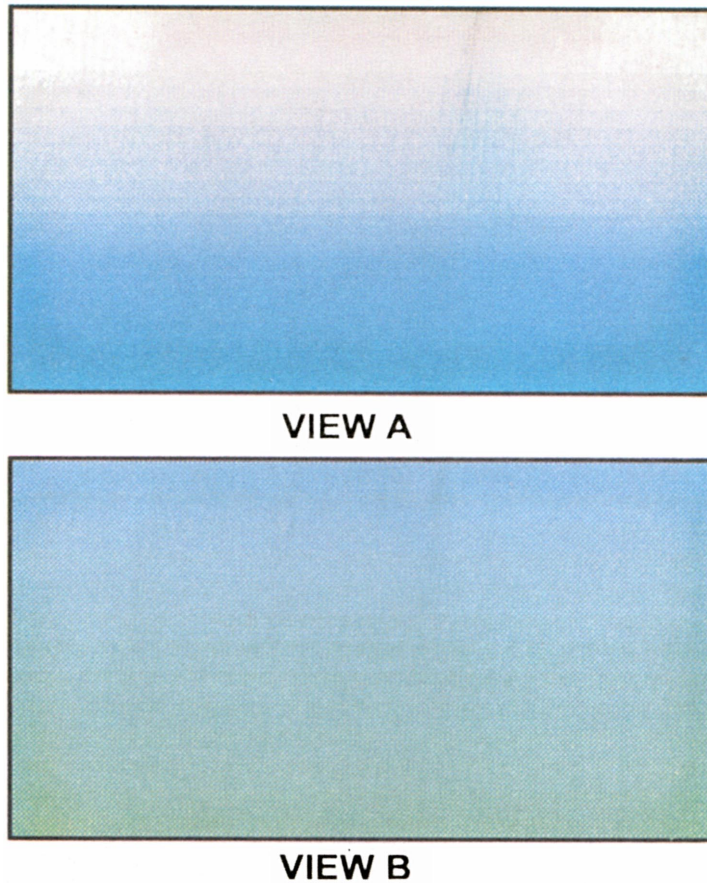

Figure 2-24.—Creating depth: A: By reduced intensity; B: By colors warmed with yellow.

Continued on next page

Subtractive Theory of Color, Continued

Luster

Luster is soft, reflected light that appears radiant or brilliant. To create a lustrous effect, use slightly shaded hues suppressed uniformly in value with black. Use pure hues for smaller areas of a painting. The suppressed colors appear natural enough; although slightly dark, the pure colors will appear exceptionally brilliant in comparison. Another technique for creating luster is to paint all colors normally, then airbrush a thin layer of translucent black over the entire painting. Repaint highlights with pure color. A third technique for creating luster in paintings is more direct. Prepare a three- or four-step low-key value range from purity to near black for each basic hue. Paint the image directly on a dark background. In the figure 2-25, a low-key value range in blues and violet accentuates a brilliant, warm, yellow highlight.

Figure 2-25 shows a lustrous view of a submarine and ships.



Figure 2-25.—Luster created through shades of violet and highlights of intense tints of yellow.

Continued on next page

Subtractive Theory of Color, Continued

Iridescence

Iridescence is a rainbow-like display of color such as seen in a soap bubble, an opal, or in mother-of-pearl. Iridescence is softer and more subtle than luster and has an illusive quality that uses diffraction to split spectral hues. The colors of iridescent objects change in value and hue when seen from different angles. You can create the illusion of iridescence by uniformity suppressing slightly shaded hues uniformly in value with grey. To create iridescence, prepare a series of medium value tints between purity and white. Keep tints clear, avoiding greyness or darkness. Paint as you would normally. When finished, airbrush a delicate coat of translucent pale grey over the entire painting until the painting appears misty. Replace touches of pure hue. Another method of creating iridescence is to mix a series of clean tints and add equal amounts of medium grey to each. Continue to grey each hue creating three or four steps from a clean hue to neutral grey. Paint as you would normally, using pure tints as highlights. This technique will establish a general overall grey cast and lend unusual iridescence to the minor areas occupied by the clean tint.

Continued on next page

Subtractive Theory of Color, Continued

Luminosity

When objects or paintings appear to have an inner glow, they are said to have *luminosity*. Light appears to come from within. To create luminosity in paintings, surround rich, pure hues with dark values or their opposite on the color wheel. If the color is not pure, the results may be disappointing. Several conditions contribute to the success of luminous painting, (1) the luminous area must be small, (2) the color that is to be luminous must be purer than surrounding color, (3) the color that is to be luminous must be of a higher value than surrounding color, (4) the luminous color must prevail over all other colors, and (5) other objects in the painting must appear soft and hazy as if the viewer's vision is blurred by the luminous object.

Figure 2-26 shows how light from the sparks thrown off by the grinder give this photograph a luminous glow.



Figure 2-26.—Luminous sparks glow from this picture.

Continued on next page

Subtractive Theory of Color, Continued

Color mixing

You will seldom use color straight from the tube. It is important to develop good color mixing habits to make sure that your colors are clean and not greyed.

Here are a few tips to help you in preparing color mixes:

- Clean your brush before you pick up any color.
 - Prevent paint from seeping up to the metal ferrule when you use your brush to mix paint. Residue paint rots brush bristles and may stain other pigments you mix.
 - Use a clean palette knife to pick up yellow. Yellow is the most sensitive color on the palette. Using a brush with residue from another color will stain yellow pigment.
 - Keep mixtures simple. Use only two or three colors plus black and white. More color will only muddy or grey your mixtures.
 - Use white carefully. White paint neutralizes other colors and may appear chalky or washed out.
 - Mix dark colors into lighter colors to economize paint and effort. It takes less paint to mix green by mixing a dab of blue into yellow than to mix a quantity of yellow into blue.
 - Darken a color by using its compliment. Compliments mixed in the correct proportions become neutralized greys. These greys may be warm or cool.
 - Dip a brush into two colors and, without mixing or palatting the brush, apply the pigments directly to the painting. This technique is a form of broken-color painting.
 - Keep two jars of water handy. Use one jar to rinse color from the brush and the other jar of water will remain clear for mixing.
-

Process Color

| | |
|--------------------------------|---|
| Introduction | Continuous-tone artwork in full color and intended for reproduction is better left to the camera person for photographic separation. Better reproductions result from using colors in the original that are similar to the colors of ink the printer uses. Master the processes used in preparing continuous-tone originals for color reproduction. |
| Color reproduction | The two categories of color reproduction methods are process color and flat color. |
| Process color | Process color is the four-color separation and printing process of continuous-tone masters requiring photographic separation of each of the three primaries plus black. The three primary process colors are cyan (blue) abbreviated (C), yellow abbreviated (Y), magenta (red) abbreviated (M). The three primary process colors plus black (K) are the foundation of the CYMK process color theory. The CYMK process color theory uses inks to reproduce color images. Each isolated color creates a plate which, when printed in turn, reproduces the original in full color. |
| How process color works | The printer makes separate negatives and separate press plates for each of the primary colors plus black (a total of four) in continuous-tone color art. The camera person may use only three negatives and three plates if the artwork is simple. Since colors photograph as black or shades of grey, the printer uses regular black-and-white panchromatic litho film. A grey scale, photographed along side the artwork assists the camera person in comparing density and contrast for each negative. Negatives should have the same density and contrast or they print out of balance. The photographer uses halftone screens and color filters when shooting color separations. The halftone screen breaks the image into dot patterns. The angle of the halftone screen changes for each color shot. This change in angular position causes the film to record dots that, when printed, overlap. A blue filter records yellow, a red filter records cyan (blue), and a green filter records magenta (red). No filter or a combination of the three filters records black in the original. The filters used by the camera person are not true blue, red, and green. Filters have numerical values based on density and color. Select the filter with the correct numerical value to achieve maximum contrast and density. Overlapping differently colored dots creates secondary and tertiary colors. |

Continued on next page

Process Color, Continued

How process color works (Continued)

Correct any flaws on the negative and expose and develop the press plates. Pull a proof from each plate in color. This proof is known as a progressive proof. If density and contrast are correct, run the plates on the press in the proper colors of ink.

Figure 2-27 shows separation negatives, progressive proofs, and a print resulting from the four-color process.



Figure 2-27.—Separation negatives, progressive proofs, and finished four-color image.

Continued on next page

Process Color, Continued

Flat color

If the color in the resulting print is simple to separate and appears without modulation, it is called *flat color*. Gradations of tone require the use of shading sheets and are photographed as line art. Spot color and fake color are examples of flat color printing processes.

Spot color

Spot color is a process used when only a small portion of an image requires color. The printer separates color areas by reading instructions attached to the original artwork on an overlay. The DM does not have to separate color on another piece of art. On complicated drawings, the DM creates overlays for each color, registers them to the master, and indicates desired ink color.

Fake color

Fake color, or pre-separated color, also uses overlays to indicate colored areas on line art or continuous-tone art. Place an overlay on the art and define the outlines of the image on the overlay. The printer will strip the separations into color panels and make separate color plates.

Color Electronic Prepress Systems

Introduction

Computers are increasingly present in the work space and many commands have access to digitized systems producing finished graphics. Digitization is also used in the creation of color separations for reproduction. You should be aware of color electronic prepress preparation and some of the serious limitations it imposes.

Color Electronic Prepress System

Color Electronic Prepress Systems (CEPS) are high-end systems that perform all the steps required to create original art and transfer it to a press plate. A CEPS is a component system containing a drum scanner, a digitizing tablet with a cursor or tracing pen, memory, software, a high-resolution color monitor, and an output device to record images.

CEPS scanners

Image and color resolution are primarily controlled by the type of scanner used to scan images. Most CEPS have a drum scanner that scans at high resolution. Images scanned by the drums of CEPS scanners may be imported to a desktop computer system for manipulation and exported back to the CEPS system for final resolution before printing. CEPS drum scanners rotate at high speed. A beam of light passes through or is reflected from copy. An internal photomultiplier tube (PMT) records the image. There is an individual PMT to record each blue, red, and green signal. Each electronic signal is fed to four separate internal computer units (blue, red, green, and black) for color correction. Signal ranges may be manually changed for effect. Corrected signals are then fed to lights that vary intensity to correctly expose film. CEPS scanners accommodate all line art, grey scale scanning, and color.

Desktop Color

Introduction Some of you have a computer system for a workstation. You should become familiar with color as it applies to computer-generated or desktop color.

Desktop color Desktop color is computer-generated color or various shades of grey from an IBM (PC) or Macintosh (MAC) computer systems. The color limitations of desktop color are the Random Access Memory (RAM) capacity of the computer, the Video Graphics Array (VGA) card, the scanner, and the monitor.

Memory Random Access Memory (RAM) determines the speed and power considerations for color. Color displays require more RAM than monochromatic displays. If your computer doesn't have enough memory, you will experience delays in completing jobs that involve color. When adding color capabilities to your desktop system, reevaluate memory capacity and expand it if necessary.

Video Graphics Array (VGA) Video graphics array (VGA) cards or Super Video Graphic Array (SVGA) cards control the resolution of computer monitors. Monitor resolution is stated in terms of dots per inch (dpi) for MAC monitors or picture elements (pixels) for PC monitors. You may use a VGA with color or black-and-white monitors. The VGA monitor has a resolution of 640 x 480 dpi. Super VGA increases the resolution to 800 x 600 dpi or 1024 x 768 (extended VGA).

Scanners Scanners scan text and images and record them to memory. The type of scanner determines the resolution of the scanned image. Scanners are classified by image capture capabilities and whether they use the theory of reflectance (opaque copy) or the theory of transmission (transparent copy). There are hand-held scanners, sheetbed scanners, flatbed scanners, overhead scanners, slide scanners, and drum scanners. Most scanners connected to desktop computer systems use sensing elements called charged-couple devices (CCD). When light strikes CCDs, they retain voltage. The voltage apportions the amount of light striking the sensors and transfers this into reproduced copy. CCD scanners are of lower resolution than the photomultiplier tube scanners of Color Electronic Pre-press Systems.

Continued on next page

Desktop Color, Continued

Image capture The three types of image capture are line art, grey scale, and color.

LINE ART: Line art is images that are either black or white and have no gradations in tone. Line art scanners record black as one bit and white as one bit. This is called one-bit or bilevel scanning. Simulating halftones in the scanned image is known as dithering.

GREY SCALE: Grey scale scanning is for continuous-tone art. The scanner assigns grey levels based on the light that reflected from or passing through the original image. Increasing bits per pixel (pixel depth) increases the number of greys recorded and proportionally increases file size. Eight-bit scanners produce 256 levels of grey.

COLOR: Desktop color scanners usually allow 8 bits per spectral primary and 8 bits for black totaling 24 bits of information per pixel. This creates a palette with more than 16 million available colors. Color monitors should be capable of displaying 24 bit color. Convert images scanned as 24 bit color to 8 bits before displaying the image on monitors incapable of displaying 24 bit color.

Color monitors Color monitors display images and text while you work in the document. The resolution and accuracy of a desktop system depends heavily on the quality of monitor. Monitor resolution is defined by dpi (MAC) or pixels (PC). Screen size is measured diagonally across the monitor face. Large monitors that display a full page or a two-page spread horizontally are ideal for the DM and this type of monitor accuracy is often called WYSIWYG (pronounced whizzywig), an acronym for What You See Is What You Get. WYSIWYG monitors and appropriate software allow the DM to create and correct art and copy with unparalleled accuracy. What you see on the horizontally oriented screen is exactly what the hard copy should look like. Vertically oriented monitors are called portrait monitors.

Summary

Review

This chapter provides an elementary explanation of light and light characteristics and a brief description of how light responds to different media, reflects off of unlike surfaces, and what this does to local color. This chapter provided an introduction of basic color theories and showed fundamental differences between additive and subtractive color theories. Process color and the technologically advanced CEPS systems are another form of color creation using inks instead of light or pigments. Desktop color is color derived from light and modified by digitization. Neither color nor black-and-white would be possible without light.

Comments

People are intrigued by color and gravitate toward it. Sometimes, poor or mediocre compositions receive praise solely on the fact that they are colorful. This is particularly true in photographs. When used correctly, color can be powerful and persuasive. Learn how to use color. Don't rely on adding color to revive poor illustrations. As an Illustrator Draftsman, you should strive to create images that remain strong with or without color. A true test of sophisticated composition is tonal clarity in black-and-white reproductions.

CHAPTER 3

DRAWING

Overview

Introduction To realistically portray three dimensional objects on the surface of a sheet of two-dimensional paper requires skill and keen observation. All forms are one, or a combination of several basic forms: Forms have mass and take up space. You will refine your drawing ability as you develop your skills of observation by seeing objects in their most elemental form.

Objectives The material in this chapter enables you to do the following:

- Develop contour and mass in three-dimensional drawings.
- Draw a solid foundation of basic shapes.
- Visually evaluate complex items in terms of basic forms.
- Recognize and avoid the most common errors of novice draftsmen.
- Use a common unit of measure to size figure drawings in correct proportions.
- Use gestures and body dynamics to suggest movement in a composition.

Continued on next page

Overview, Continued

In this chapter This chapter covers the following topics:

| Topic | See Page |
|---|-----------------|
| Basic Drawing | 3-3 |
| Contour Drawing | 3-4 |
| Gesture Drawing | 3-10 |
| Basic Shapes | 3-11 |
| Combining Forms | 3-16 |
| Basic Rendering Techniques | 3-19 |
| Figure Drawing | 3-24 |
| Figure Elements | 3-36 |
| Facial Features | 3-42 |
| Rendering Techniques for Figure Drawing | 3-49 |
| Expression | 3-54 |
| Settings | 3-56 |

Basic Drawing

Introduction Most of us doodle. We draw when we attempt explanations and words elude us. We sketch things to jog our memories later. Some of us draw for the pleasure of expression.. For those who draw seriously, contour, gesture drawing, and basic forms are three techniques for developing basic drawing skills.

Basic drawing Drawing is comprised of five component skills involving the perception of edges, space, relationships, light and shadow, and the perception of the whole, or gestalt. Everyone draws, and how well one draws is a measure of how well-developed one's basic skills of perception are.

Advanced drawing Drawing well requires all five basic skills with additional refinements. You develop imagination, creativity, sensitivity, and expression through techniques and your familiarity with media. The only way to progress in drawing is with constant practice.

Practice With practice, you can easily imitate perceived edges, space, and relationships on paper. Duplicating light and shadow requires careful observation and critical analysis of the direction, intensity, and color of light and shadows cast by light. Observation also requires intimate knowledge of the surface characteristics of the object on which the light and shadows fall. Gestalt results from the development of the other four perceptual skills.

Traditional drawing skills Most renown artists began by studying traditional art. After a foundation in traditional drawing techniques, experimentation and style freely develop. Picasso and Salvatore Dali are prime examples of artists with concentrated traditionalist backgrounds resulting in creative interpretations. A study of Picasso's preliminary sketches reveals his continued dependence on contour and gesture fundamentals.

Exercises Time your drawings for each technique described in this chapter. Every three minutes, change your object or your viewpoint. Vary the timed intervals by reducing times to 1 or 2 minutes. These timed exercises develop perceptual and observation skills by coordinating your eyes and hands.

Contour Drawing

Introduction

Train your eyes to see shapes and contours and your hands to transfer what you see to paper. The strokes you make and the strokes you omit should economically convey perceived images. The six types of contour drawing are contour, blind, felt, cross, negative, and inversion contour.

Contour drawing

Contour drawing is the process of drawing the contours or outlines of objects. Such definitive outlines do not exist in nature but, a thorough knowledge of contour is necessary to realistically convey imagery and proportion. To draw in contour, study the object, then the paper surface. Draw what you have seen. Do not draw detail. Your drawings should appear as outlines. The more you practice, the better you are able to draw the shape and proportion of the object.

Figure 3-1 shows an example of a contour drawing of a telephone.

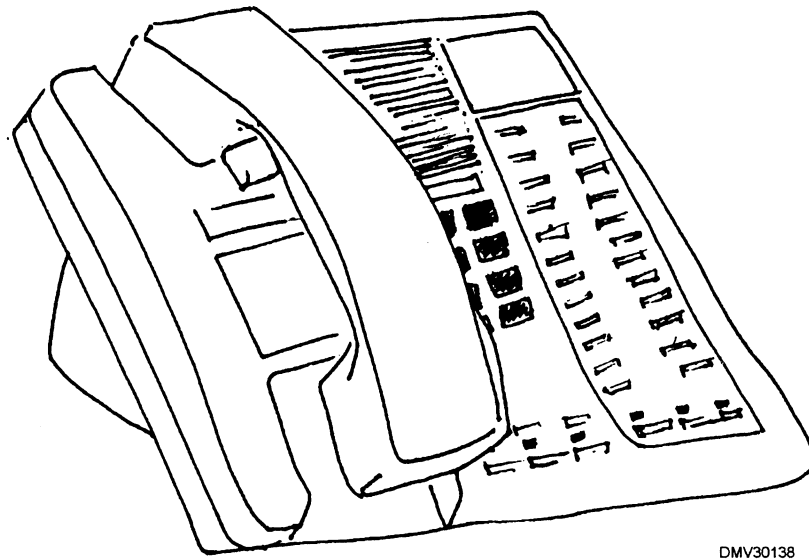

Figure 3-1.—A contour drawing of a telephone.

Continued on next page

Contour Drawing, Continued

Blind contour

Blind contour is also an outline drawing but, without the benefit of seeing what is drawn. To draw in blind contour, study the object only, not the paper. If you inadvertently look at the paper surface, stop drawing and do not continue until your eyes return to the object. Follow the contour of the object with your eyes. Make your hands draw without the benefit of looking at the paper. This drawing format develops coordination and seeing beyond the physical outline of the object.

Figure 3-2 is an example of a blind contour drawing of a telephone.

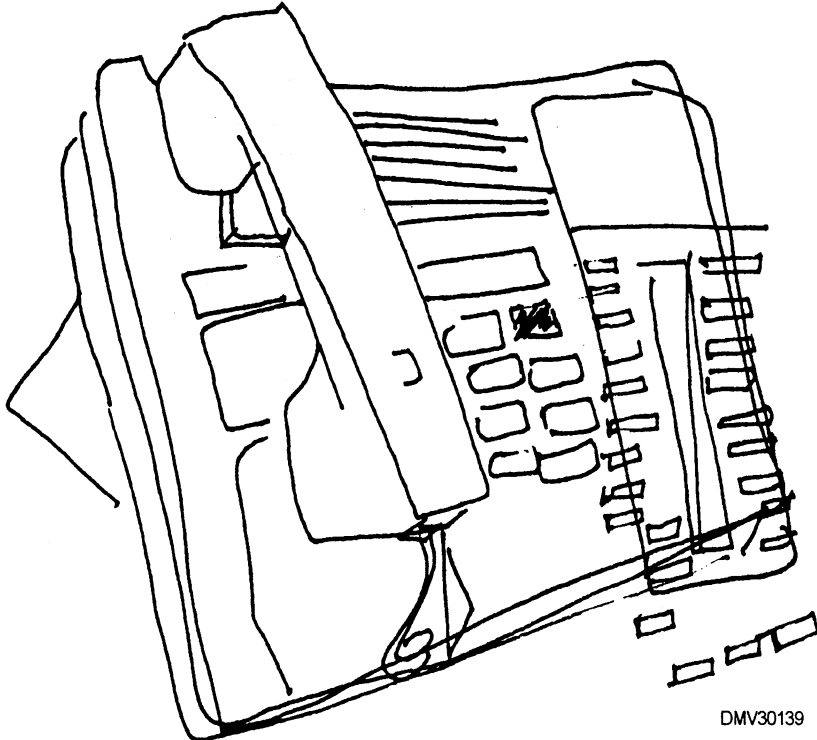

DMV30139

Figure 3-2.—A telephone in blind contour.

Continued on next page

Contour Drawing, Continued

Felt contour Felt contour drawing is an outline that explores the surface characteristics of the object. This drawing format is called felt contour because you are drawing what your eyes perceive as the outline and texture of the object. To draw in felt contour, look at the object and close your eyes. Imagine the feel of the surface texture and outline of the object. With your eyes closed, draw the object on paper. The resulting drawing will be jagged and perhaps, illegible. This exercise in felt contour drawing develops perception.

Figure 3-3 is an example of felt contour drawing.

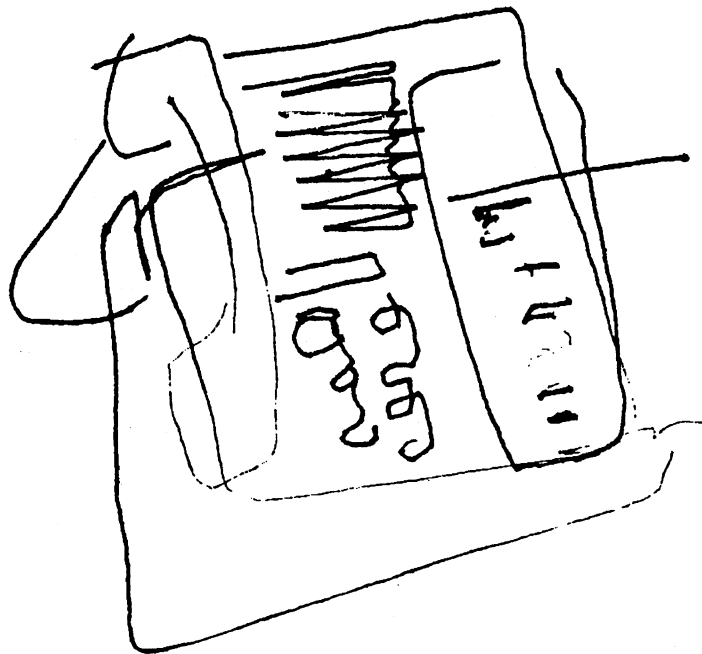

Figure 3-3.—Felt contour.

Continued on next page

Contour Drawing, Continued

Cross contour Cross contour is outline drawing of objects but, with topographical cross-hatching indicating surface characteristics and mass. To draw in cross contour, study only the object, not the paper surface for the outline. Draw the outline in blind contour. Draw in basic contour, vertical and horizontal lines that appear to lay on the surface of the drawn object compresses or expands to imply surface texture. This exercise also develops perceptions of edges and surface characteristics.

Figure 3-4 is an example of cross contour drawing of a telephone.

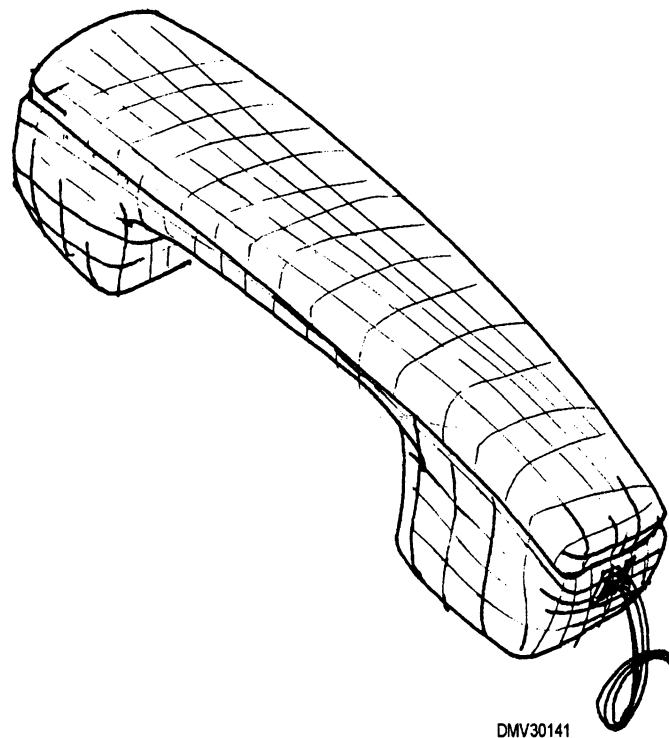

Figure 3-4.—A cross contour drawing of a telephone.

Continued on next page

Contour Drawing, Continued

Negative contour

Negative contour is drawing the outline of the negative space surrounding an object as opposed to a positive contour drawing of the object itself. To draw in negative contour, look at the shape of the space around the object. Draw the space without consciously drawing the object outline. Negative contour drawings suggest the presence of objects. Negative contour drawings develop a sense of space, not only the space the object occupies but also the space around the object and the object's relationships to other elements in the area.

Figure 3-5 is an example of a negative contour drawing.

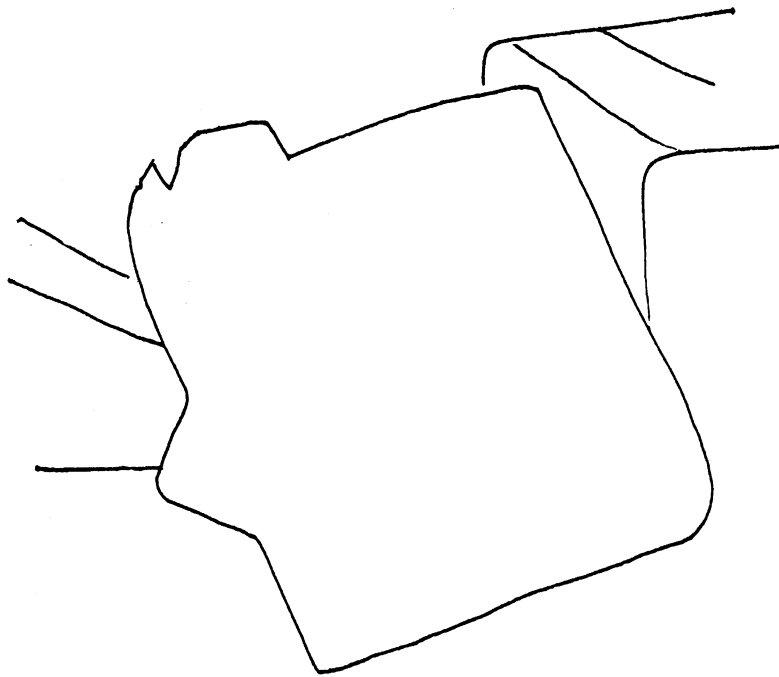

Figure 3-5.—A drawing of a telephone in negative contour.

Continued on next page

Contour Drawing, Continued

Inversion contour

Inversion contour drawing is a contour drawing drawn upside down, bottom up, or right to left. The point of drawing in this way is to remove the familiarity of the object. This technique forces you to carefully examine the object from an unfamiliar perspective.

Figure 3-6 is a telephone in inverted contour.

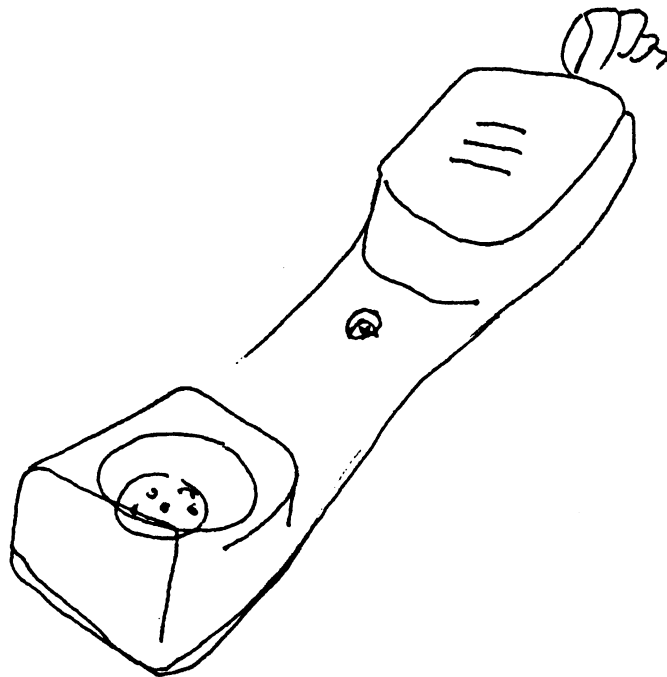

Figure 3-6.—A telephone drawn in inverted contour.

Gesture Drawing

Introduction

In addition to an outline, objects have perceived mass and weight. Correctly portraying mass gives drawings a three-dimensional feel.

Gesture drawing

Gesture drawing is an important technique for developing the ability to draw figures. Gesture drawings are rapidly executed drawings of mass and weight that do not involve outlines or details. To draw in gesture, look only at the object, not at the paper. As you move your eyes over the object, continuously and rapidly move your crayon over the paper. Linger over the areas with weight or mass. You may draw using short abbreviated strokes or you use a continuous stroke never removing the crayon from the paper. Sparsely draw those areas on the object with little weight or mass. Initially, your drawings may appear childlike. After extended practice in gesture drawing, you should perceive weight and mass realistically and with correct proportion.

Figure 3-7 shows examples of practice gesture drawings.



DMV30144

Figure 3-7.—Gesture drawing.

Basic Shapes

Introduction

All forms, regardless of complexity, have, as their basis, one or a combination of basic shapes. Although an object may not perfectly duplicate a basic shape, the shapes are present. Objects are three dimensional in structure. The three dimensions are height, width, and depth.

Basic shapes

The four basic shapes are the cube, the sphere, the cylinder, and the cone. Describing objects by using basic forms simplifies the process of drawing and laying out forms on a page. Draw basic shapes as if they were made of glass to see both the inside and outside of the objects. This technique is called *drawing through* an object and enables you to give objects depth as well as height and width.

Figure 3-8 shows the four basic shapes in drawing.

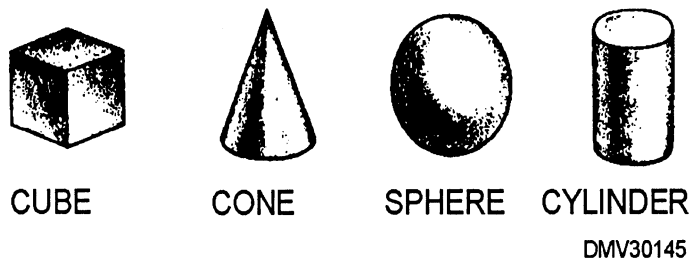

Figure 3-8.—The four basic shapes.

Figure 3-9 shows basic shapes drawn as if they were made of glass.

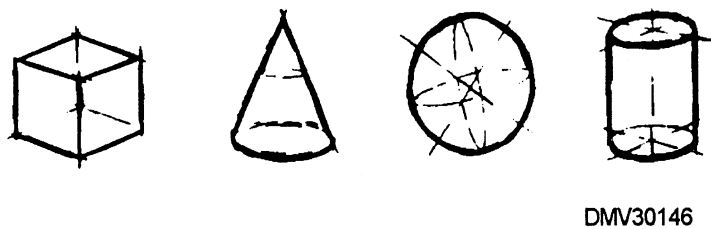

Figure 3-9.—Drawing through basic shapes as if they were made of glass.

Continued on next page

Basic Shapes, Continued

Cubes

Cubes are squares with equal height, width, and depth dimensions. Perspective or viewpoint alters the perceived dimensions of the cube. Varying the dimensions of the cube creates rectangles. Shading and texture modify the basic shape of the cube and more clearly defines objects.

Figure 3-10 shows the dimensions of a cube.

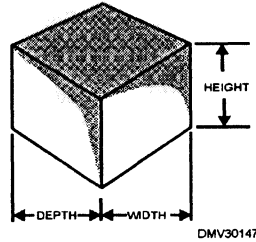

Figure 3-10.—A cube.

Figure 3-11 shows a modified basic cube shape with shading and texture.

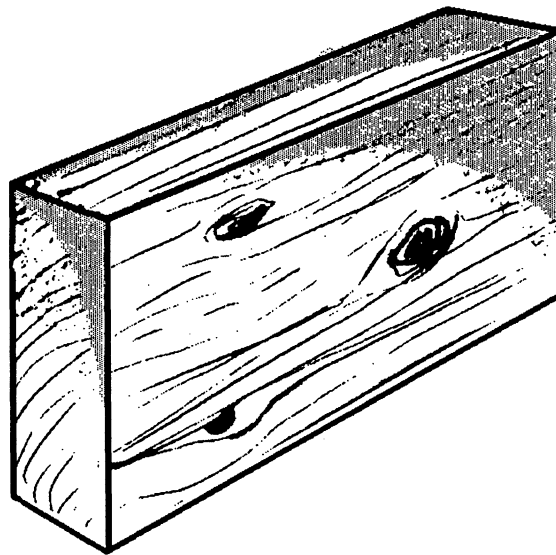

Figure 3-11.—A modified cube with shading and texture.

Continued on next page

Basic Shapes, Continued

Spheres

Spheres are round. The distance from the center of the sphere to any edge of the sphere is known as the *radius*. The radii of spheres extend equally in all directions from the center. A sphere appears round regardless of viewpoint or perspective. Shading on spheres is soft and gradual with no abrupt planes creating sharp contrasts. Changing the length of the radii creates ellipses. Use ellipses to define the depth of spheres.

Figure 3-12 shows the dimensions of a sphere.

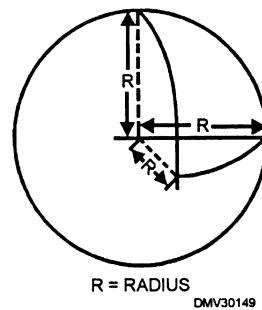

Figure 3-12.—Radii.

Figure 3-13 shows how ellipses define the depth of a sphere.

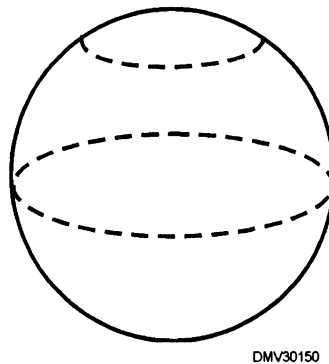

Figure 3-13.—Ellipses define the depth of a sphere.

Continued on next page

Basic Shapes, Continued

Cylinders

Cylinders appear as tubes. Construct cylinders by drawing two parallel lines. Define the width of the cylinder with ellipses. Use shading to accentuate the roundness of the tube.

Figure 3-14 shows a cylindrical form.

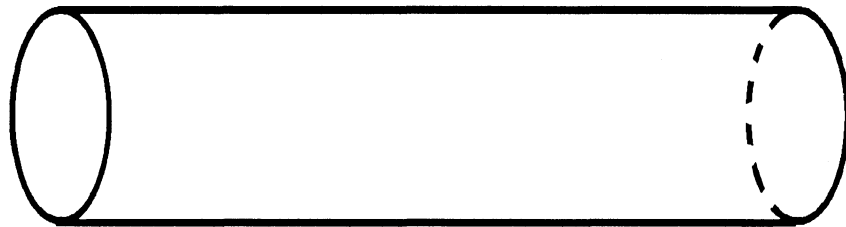

DMV30151

Figure 3-14.—A cylindrical form.

Figure 3-15 shows a cylinder with shading added.

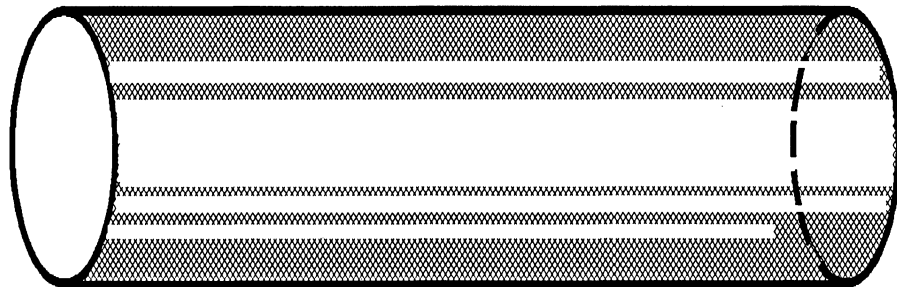

DMV30152

Figure 3-15.—A shaded cylinder.

Continued on next page

Basic Shapes, Continued

Cones

Cones appear triangular in shape but, have a circle or ellipse as a base. Lines converging to some point above or below the base determines the height of a cone. Shading defines the roundness of cones.

Figure 3-16 shows a basic cone.

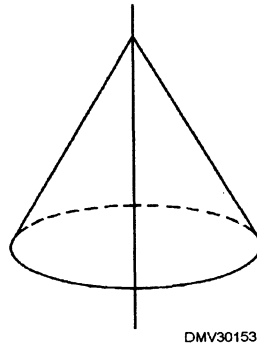

DMV30153

Figure 3-16.—A cone.

Figure 3-17 shows how shading changes the cone into a tree.

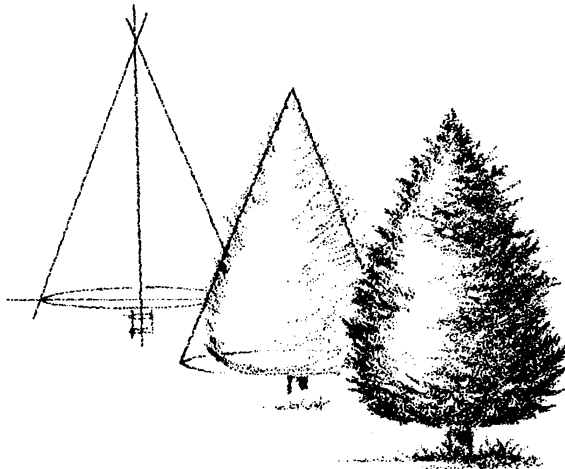

Figure 3-17.—Changing the conical form to trees.

Combining Forms

Introduction

Regardless of how complicated objects seem, you can reduce them to a combination of the four basic forms. Train yourself to see all objects in their basic forms. Practice combining basic forms to create complex objects.

Combining forms

Basic forms combine to create complex objects. For example, a close look at a foot reveals a series of cylinders (toes), a wedge or modified cube (forefoot), and a sphere (heel). By drawing basic forms proportionally, you can draw a human foot.

Figure 3-18 shows a foot reduced to basic forms.

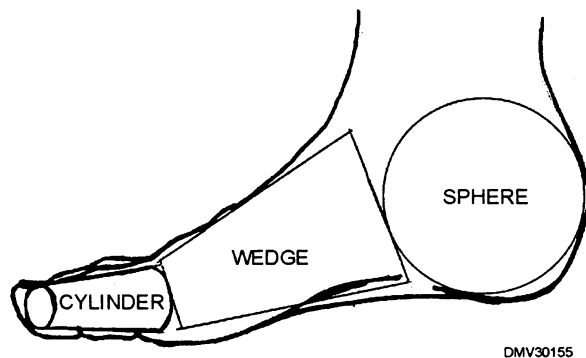

Figure 3-18.—A human foot reduced to basic forms.

Thumbnails

Before drawing, imagine the best descriptive view for your illustration. Draw several small sketches or thumbnails to determine the best view. Draw general shapes or masses without details. Establish correct proportions for larger objects first, then proportion smaller objects. When you have a very rough outline of the best possible view, you are ready to enlarge the sketch and begin drawing.

Enlarging the sketch

Once you select the best view of the object, transfer the mass and proportions to paper for the finished drawing. Indicate areas of mass without detail. Make sure proportions are correct. Keep the drawing clean and free of unnecessary lines.

Continued on next page

Combining Forms, Continued

Drawing forms Examine the object for basic forms. Sketch the basic forms on the drawing. Forms may overlap, invert, or have slight variations. Draw only forms.

Figure 3-19 shows basic forms used to draw a cannon.

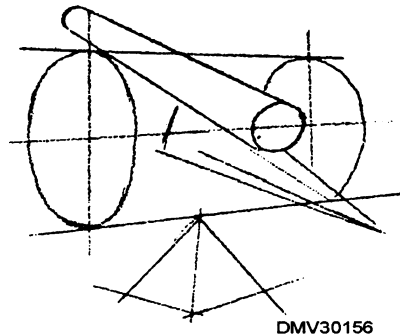

Figure 3-19.—Basic forms drawn in perspective.

Figure 3-20 shows additional basic forms (spheres) drawn proportionately to the first set of cubes to imply cannonballs.

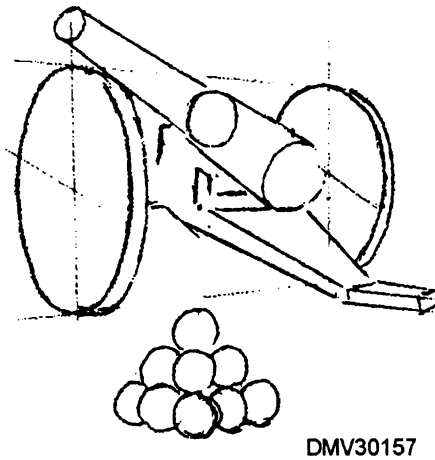

Figure 3-20.—Additional basic forms define the first set of cubes.

Continued on next page

Combining Forms, Continued

Shading

Add shading to drawings after all objects are reduced to basic forms. The most natural light comes from above and to one side of an object. Light from one source is easier to draw than light from multiple sources. Make sure shading results from the same source or sources of illumination for all objects in the drawing.

Details

Add details to drawings only after completing the shading. Details in the foreground of illustrations appear clearly. To add realism to the illustration, blur details as they recede into the background.

Figure 3-21 shows shading and details added to the basic form of the cannon.

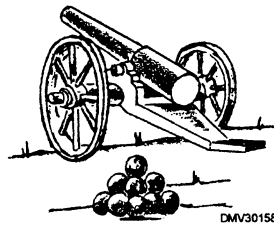

Figure 3-21.—Shade and detail added to a composite of basic forms.

Figure 3-22 illustrates the illusion of depth created by blurring details in the background.

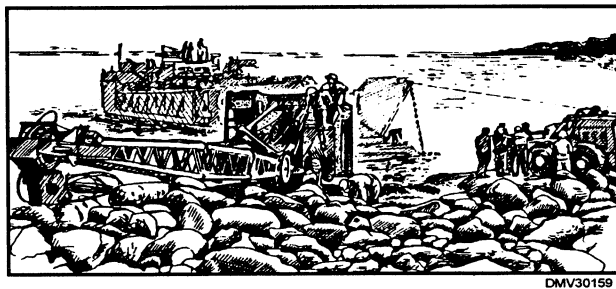

Figure 3-22.—Blurred background detail gives the illusion of depth in illustrations.

Basic Rendering Techniques

Introduction

Correct shape and proportion is only half the number of steps necessary to create effective drawings. How you render viewpoint, arrangement, and the effects of light determines the success of your illustrations.

Viewpoint

Viewing objects from different positions changes the appearance of objects. With the exception of the sphere, forms always change as the angle of view changes. Avoid viewpoints that obscure objects beyond recognition. Limit your use of viewpoints that leave the viewer off balance or disoriented unless this is your intent.

Figure 3-23 shows the normal view of an object together with an unusual viewpoint of the same object.

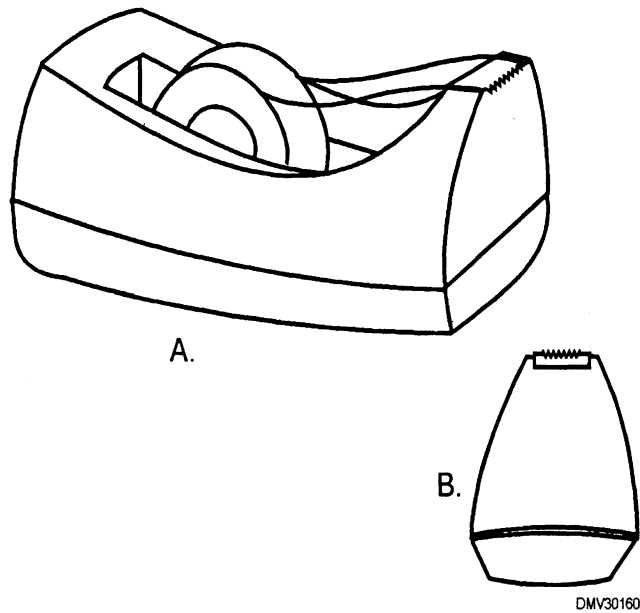

Figure 3-23.—A tape dispenser drawn using a normal viewpoint (View A) and an unusual viewpoint (View B).

Continued on next page

Basic Rendering Techniques, Continued

Arrangement

A good foundation in perspective drawing is necessary to draw convincing illustrations. Each form occupies space and space surrounds each form. Drawing through objects helps to place them correctly in relation to the other forms in the drawing. Thumbnail sketches allow you to manipulate objects in illustrations before committing yourself to a finished drawing.

Figure 3-24 shows how some arrangements of objects make illustrations effective while other arrangements of the same objects make them ineffective.

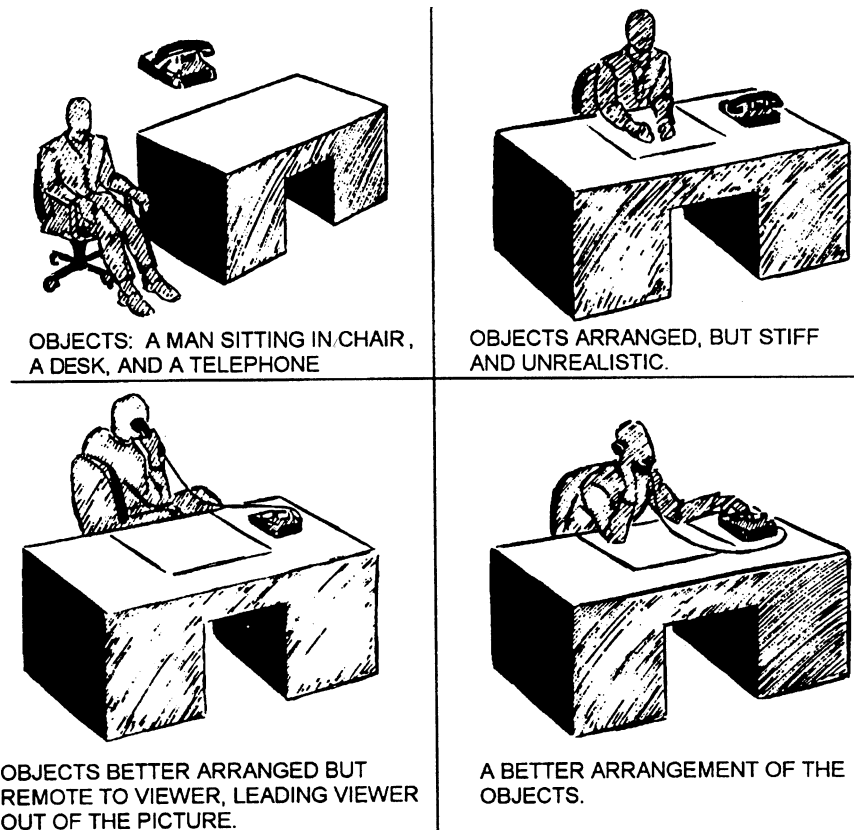

DMV30161

Figure 3-24.—Effective and ineffective arrangements of objects.

Continued on next page

Basic Rendering Techniques, Continued

Light

Light, shade, and shadow make drawings more realistic. But shading, no matter how well done, will not improve poorly constructed forms. Light, shade, and shadow are affected by two types of light: artificial and natural (outdoor) light. You can control artificial light, but not natural light. The edges of light and dark areas follow the contour of surfaces or planes of objects. If light emanates from more than one source, make sure the highlights and shadows are consistent for each object in the drawing.

Tone

Tone is the natural color of an object as compared to its surroundings. Tone separates objects from items around it. If you draw an object using only its local tone, the drawing would appear flat and without form. Consider how light or dark the color of an object is in relation to the colors of things nearby. Evaluate the tone of an object based on one of these four tone patterns: light against dark, dark against light, halftone and dark against light, and light and dark against halftone. Separate tones of objects into tonal values.

Figure 3-25 shows a cube in local tone.

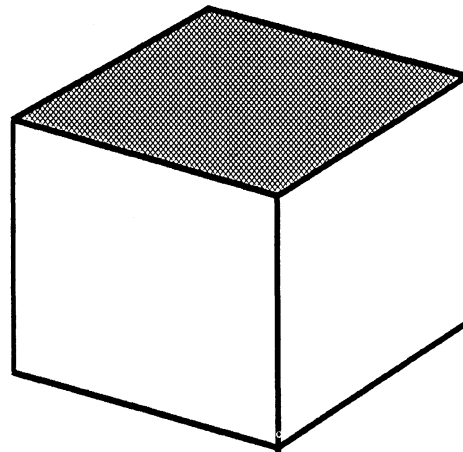

DMV30162

Figure 3-25.—A cube in local tone.

Continued on next page

Basic Rendering Techniques, Continued

Value

Value is the lightness or darkness of tone illuminated by light. Value emphasizes the form of an object. As light strikes an object, areas of light, shade, and shadow appear. Areas struck directly by light may lose local color entirely. Those areas are called highlights. Areas that receive no direct light and appear close to the local color are called halftones. Areas in the shadows or that have a shadow cast over them are darker than the local tone.

Figure 3-26 shows a cube with tonal values.

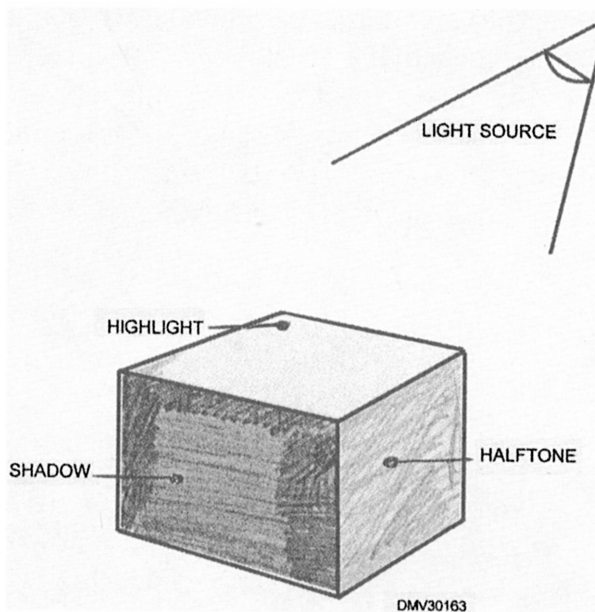

Figure 3-26.—Tonal values of a cube.

Using light, tone, and value

You can use light, tone, and value instead of lines for defining shapes or objects. Select a set or scale of values in the medium of your choice. Compare this scale of values to the natural values of the object. It is sometimes helpful to view the object through partly closed eyes to eliminate detail. Separation between value areas will depend upon the intensity of the light source. Bright light produces well-defined value separations, soft light has the opposite effect. Angular or planed edges have sharply defined value areas. Rounded areas are softly defined and gradual. Hard surfaces have values separated to the extreme while textured areas appear grainy.

Continued on next page

Basic Rendering Techniques, Continued

Reflection

Light from surrounding surfaces reflects back onto an object. Therefore, reflected light modifies shadow areas. Shiny or polished surfaces, such as water, desk tops, floors, and metal objects act like mirrors and catch images of their surroundings. Indicate the most prominent features in the reflection without too much confusing detail. Often reflections are distorted depending on the surface texture of the reflecting surface.

Figure 3-27 shows water reflecting the buildings on the shoreline above it.

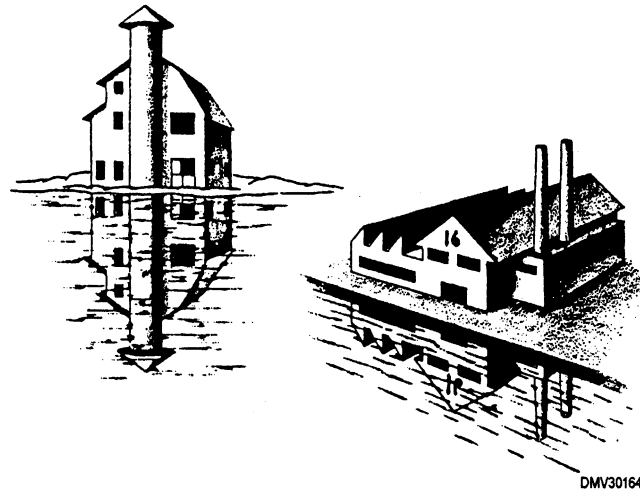

Figure 3-27.—Reflections of buildings off water.

Light source

The direction light comes from alters the appearance of objects. Arrange a light source to come from the direction that best emphasizes the form. Light falling diagonally on subjects from above and to one side of the picture area is the most natural form of illumination. Shadows cast from this position create the greatest apparent depth and roundness. A lower angle of light casts longer shadows. Side lighting is effective for showing texture. To eliminate confusing edges and shadows, use a single light source rather than several.

Figure Drawing

Introduction

One of the most difficult skills to learn is drawing figures. The principal reason beginners have trouble drawing the human figure is that they want to immediately start drawing fully clothed subjects in completed poses. Objectively reducing the human figure to basic shapes with mass and weight greatly simplifies the task of drawing people.

Approaching figure drawing

There are three ways to develop a solid foundation in figure drawing. No one approach provides sufficient perceptual development to draw figures realistically. The three approaches to figure drawing are gesture drawing, reduction to basic forms, and composite drawing.

Gesture drawing the human form

Gesture drawing captures the characteristics of the shapes you draw. Gesture drawings imply characteristics such as overall mood, weight, and physical structure. Imagine how the object or figure feels all the way around. Feel how heavy or light the figure appears. Developing your ability to draw in gesture is a necessary step in developing the perceptual skills necessary to render human form.

Figure 3-28 shows how gesture drawing implies exaltation or dejection.



Figure 3-28.—Gesture drawing implying exaltation and dejection.

Continued on next page

Figure Drawing, Continued

Reducing the figure to basic forms

If you find drawing the human figure intimidating, examine the figure in terms of basic forms. The human figure is a combination of basic forms. Reducing the figure to a series of cubes, spheres, cones, or cylinders simplifies the task of rendering figures by breaking the task into manageable segments.

Figure 3-29 shows how to reduce the human figure to basic forms.

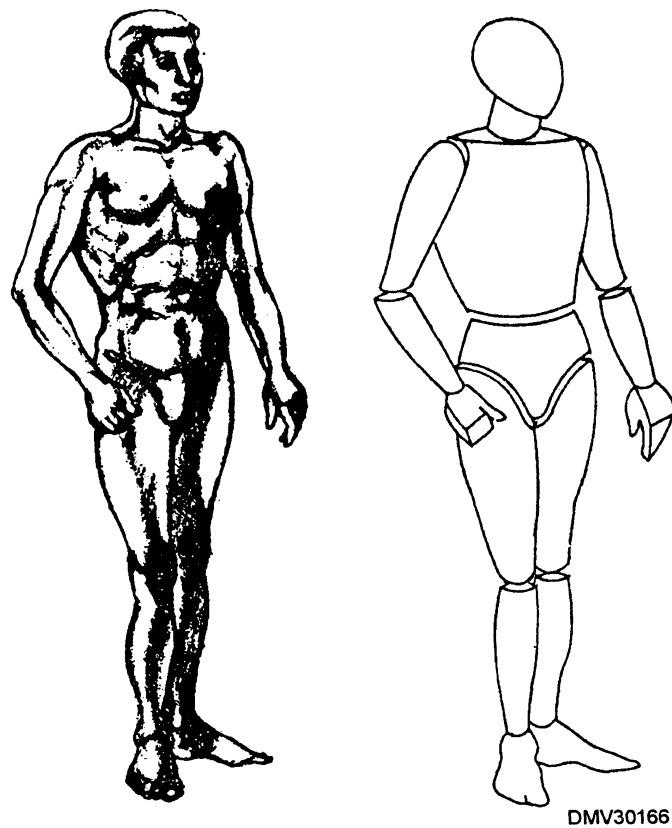

Figure 3-29.—The human form reduced to basic shapes.

Continued on next page

Figure Drawing, Continued

Combining the techniques of gesture drawing and reducing the figure into basic forms

A combination of gesture drawing and basic forms works well to help you understand figure dynamics. Try combining gesture drawing and basic forms construction. Draw a figure in gesture. Do not attempt any detail and strive only for the weight and body dynamics. After the gesture drawing, draw basic forms lightly over the masses. Modify and refine the basic forms to more closely resemble human features.

Figure 3-30 illustrates the technique for combining gesture drawing with basic forms to create a human figure.

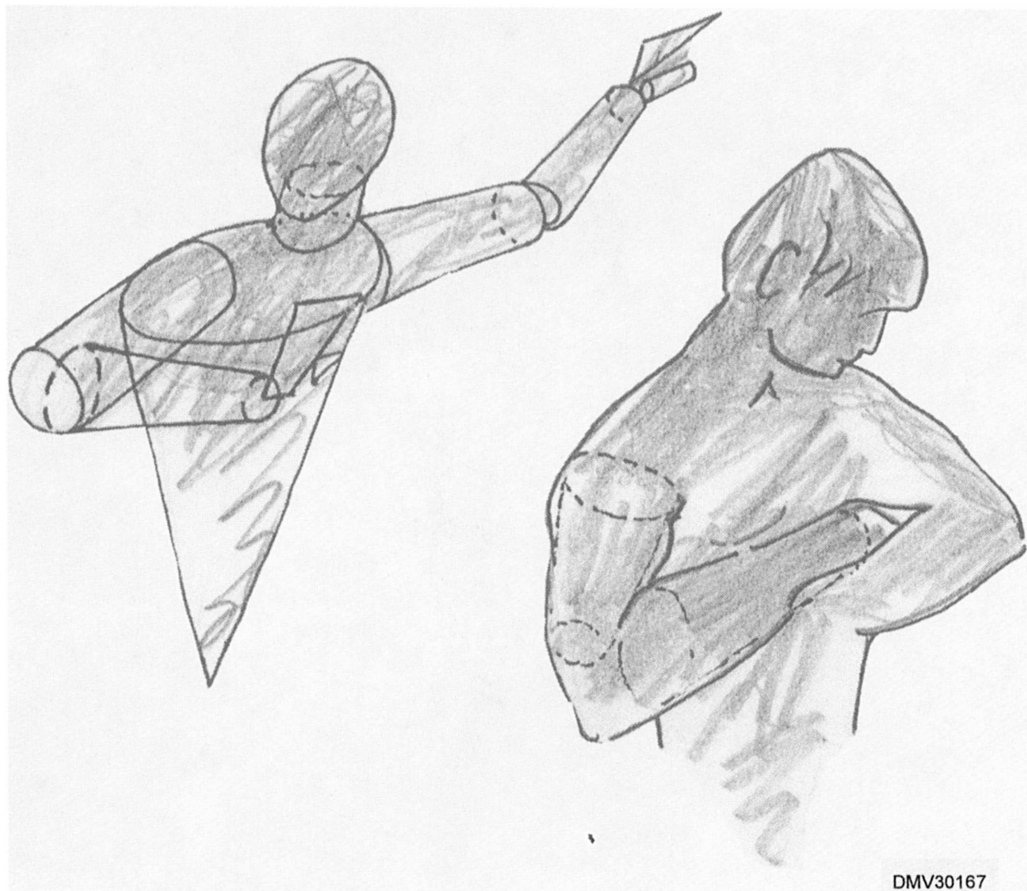

Figure 3-30.—Combining gesture drawing with basic forms to create human figures.

Continued on next page

Figure Drawing, Continued

Composite drawings of the figure

Composite figure drawing is beneficial when drawing dynamic figures (figures in extreme action positions), figures under stress or strain, and well-developed realistic figures. A composite drawing is drawing in layers. Starting with the bone structure, add musculature, and finally, add skin covering. Drawing the figure through composite drawing develops an understanding of the distinct effect on the outward appearance of mass, structure, and carriage. The base drawing is bone structure. You can draw the next layer directly over the bone drawing or place an overlay (in registration) over the base drawing to draw musculature. The final drawing is a contour or outline of the skin surface as it covers the mass of bone and muscle.

Figure 3-31 illustrates the steps of drawing a composite figure.

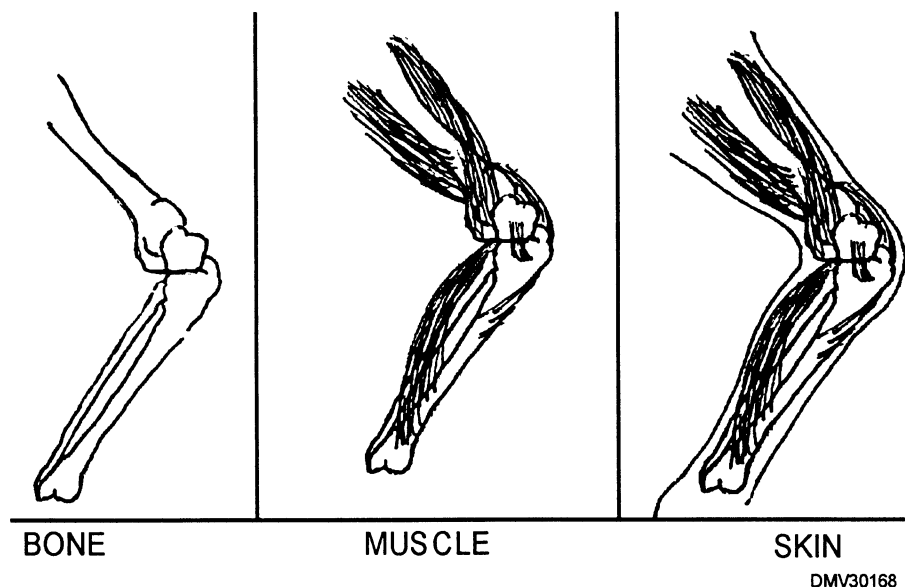

Figure 3-31.—Composite drawing.

Continued on next page

Figure Drawing, Continued

Composite
drawings of the
figure
(Continued)

Figure 3-32 are examples of dynamic figure drawing.

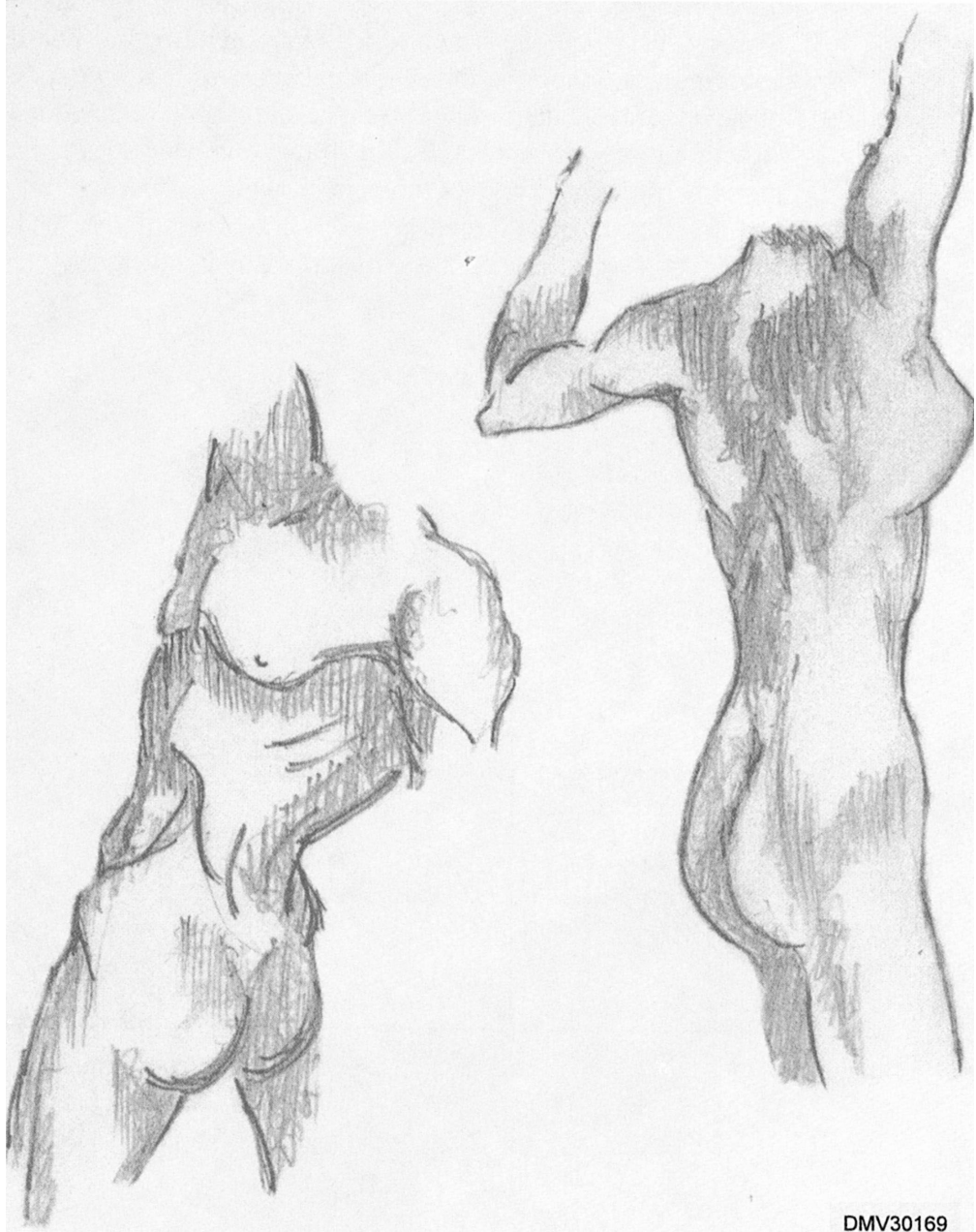

Figure 3-32.—Dynamic figure drawing.

Continued on next page

Figure Drawing, Continued

Composite drawings of the figure (Continued)

When drawing composite drawings of male and female figures, notice that the bones of the female figure are smaller and smoother. Her pelvis is wider than her rib cage. The female figure has a shorter, straighter collarbone resulting in narrow, sloping shoulders and a long neck. The male figure has a larger skull and an overall larger bone structure than the female. The male breastbone is longer and his pelvis is narrow, deep and approximately the same width as his rib cage. The rib cage of the male figure is short as is the distance between the rib cage and pelvis as a result, the male torso appears shorter than that of a female.

Figure 3-33 identifies the bone structure of male and female figures and shows the relative difference in size.

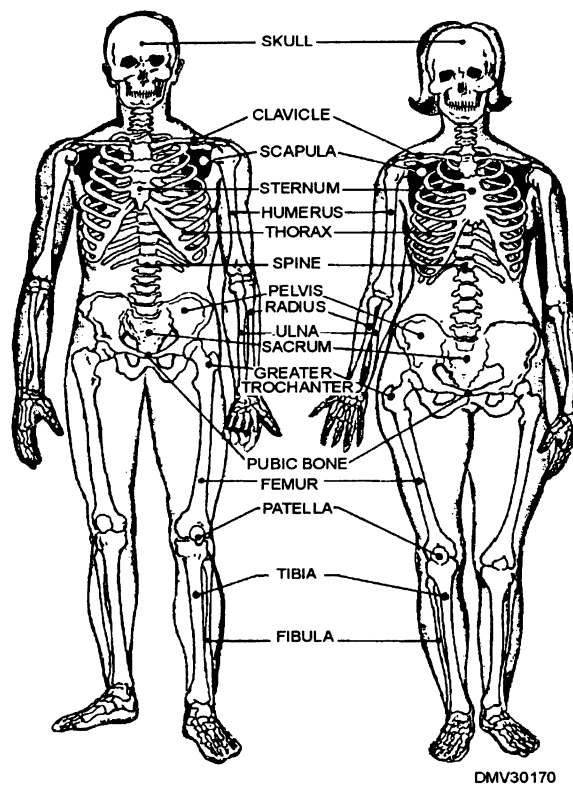

Figure 3-33.—Differences in bone structure for male and female forms.

Continued on next page

Figure Drawing, Continued

Common errors The beginning draftsman initially tries to draw figures with too much detail. Until you develop your ability to draw figures well, you shouldn't sabotage your efforts by overcomplicating the task. Draw figures without clothes and without details.

Figure proportions Another difficult aspect of figure drawing is understanding proportion. Figure proportion refers to the relative length of the arms, legs, torso, and head. To simplify figure proportion, use the head as a standard unit of measure. The distance from the chin to the top of the skull is used for vertical measurements and the distance from ear to ear is used for horizontal measurements. The head unit cannot be specified in inches; measure each figure in terms of its own head size.

Measuring adult figure height with the head The average adult human figure is 7 ½ heads high. But, most people's legs are short compared to the rest of their body and drawing them this height makes them appear stout. Round the average adult human figure to 8 heads in height. Although the male is usually taller than the female, use 8 head units for both. Remember, you measure each figure by its own head size.

To apportion the 8 head unit height for the adult figure, use this table:

| Segment | Size |
|---|------------------|
| Head | 1 head high |
| Neck | 1/3 head high |
| Torso (from the bottom of the neck to the crotch) | 2 2/3 heads high |
| Upper leg (crotch to just below the knee) | 2 heads high |
| Lower leg (below the knee to soles of the feet) | 2 heads high |

Continued on next page

Figure Drawing, Continued

Measuring
adult figure
height with the
head
(Continued)

Figure 3-34 shows the heights in head units of male and female figures.

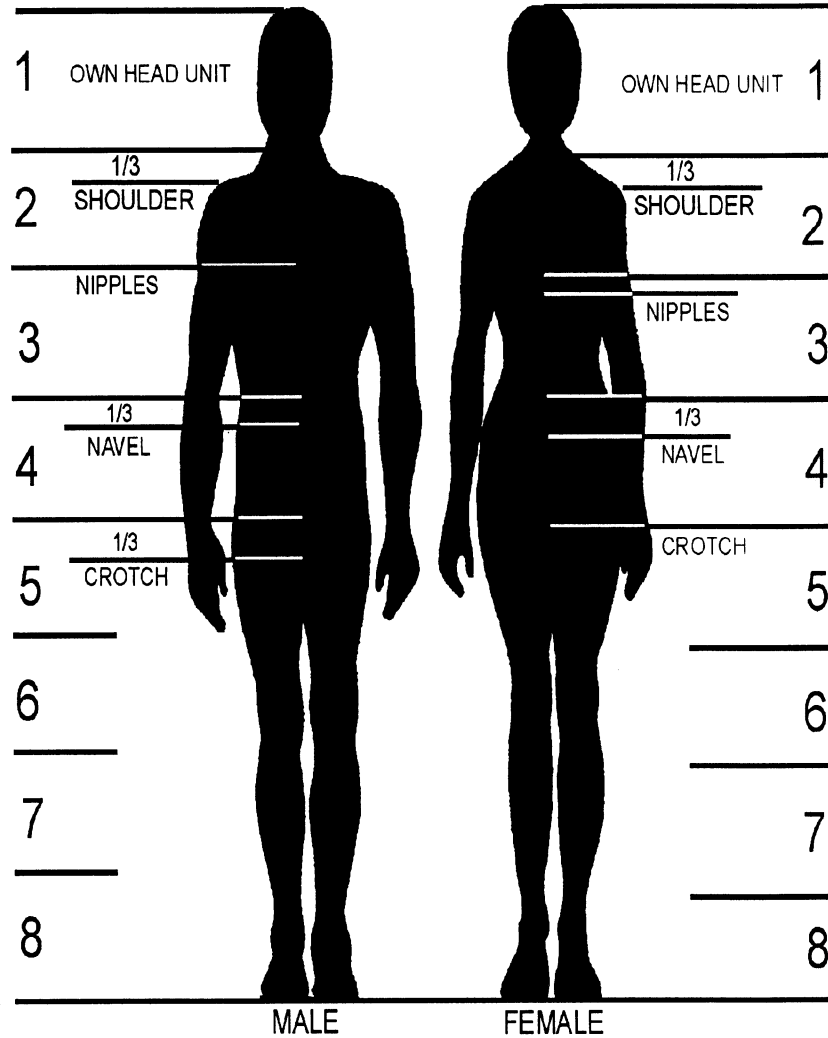

DMV30171

Figure 3-34.—The heights of male and female forms indicated by units of their own heads.

Continued on next page

Figure Drawing, Continued

Measuring adult figure width with the head

The width of the head from ear to ear is used to proportionally measure the width of the human figure. Male shoulders are a full 3 heads wide and his hips are 2 heads wide. A male figure is generally thick and angular. Female shoulders and hips are nearly equal in proportion. The shoulders of a female figure taper and appear more round.

Figure 3-35 shows the differences in head units in width between a male and female figure.

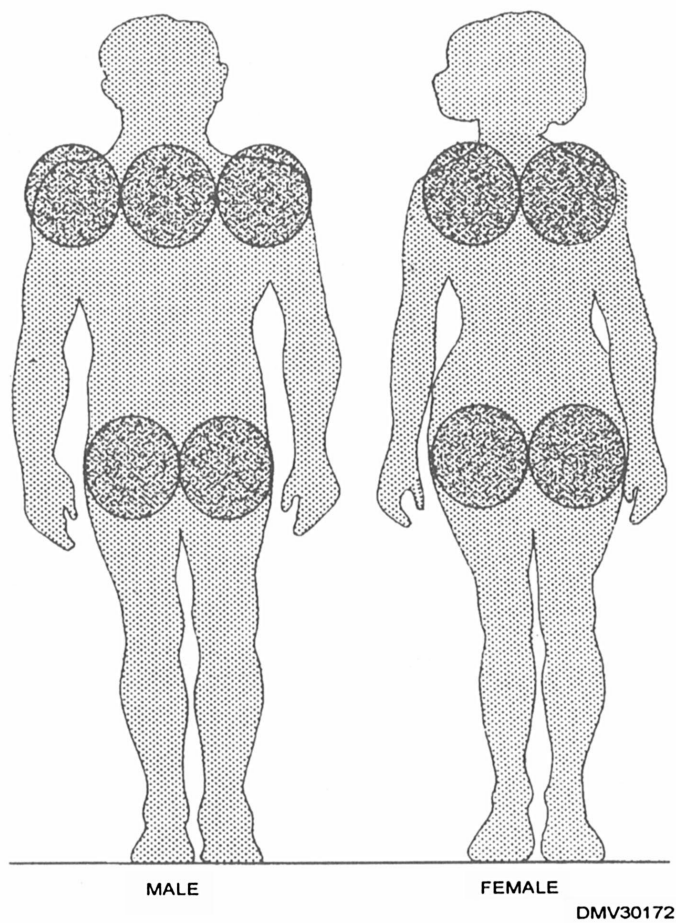

Figure 3-35.—Relationship of the head to head unit of measure to the widths of male and female figures.

Continued on next page

Figure Drawing, Continued

Figure profiles The important thing to note in the profile of male and female figures is that they are not symmetrical. The center of gravity passes through the center of the head, chest, hips, and feet. Most of the neck and lower back fall behind the center of gravity, while the largest part of the midsection is in front of the centerline. The curve of the back has a slight and continuous “S” shape. In profile, female figures appear narrower than male figures. Female figures also have less developed muscles, smaller arms, wrists, ankles, and feet. The breast and crotch of male figures are slightly higher and the waistline slightly lower than female figures.

Figure 3-36 shows differences in the profiles of male and female figures.

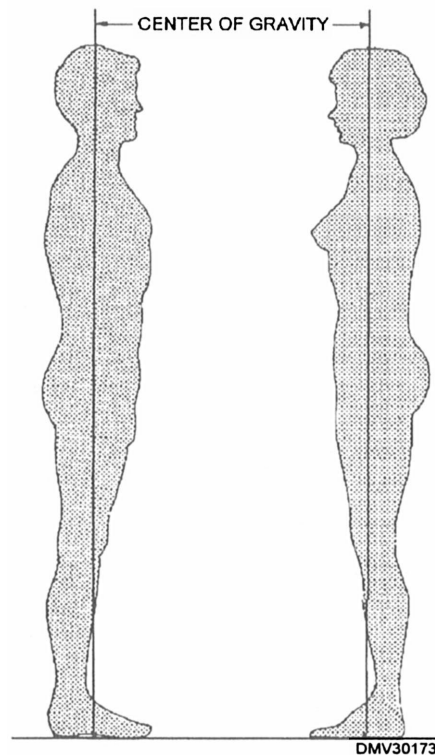

Figure 3-36.—Profile differences in male and female figures.

Continued on next page

Figure Drawing, Continued

Measuring the child figure with the head

The proportions of the human figure change at various ages. At birth, a baby's head is large compared to the rest of its body. At the age of 1 year, the overall height of the body is $4\frac{1}{2}$ head units. The neck to the feet measures $3\frac{1}{2}$ heads. By the age of 8, the average overall height is $6\frac{1}{4}$ heads. The center of the body is just above the hips and the arms and legs are longer than at the age of 1 year. At the age of 12, the overall figure is 7 head units high and the center of the body is now the crotch. From this age on, the body broadens, becomes slightly taller, and assumes the characteristics of the typical male or female form.

Figure 3-37 shows the proportional changes in height of a child at various ages.

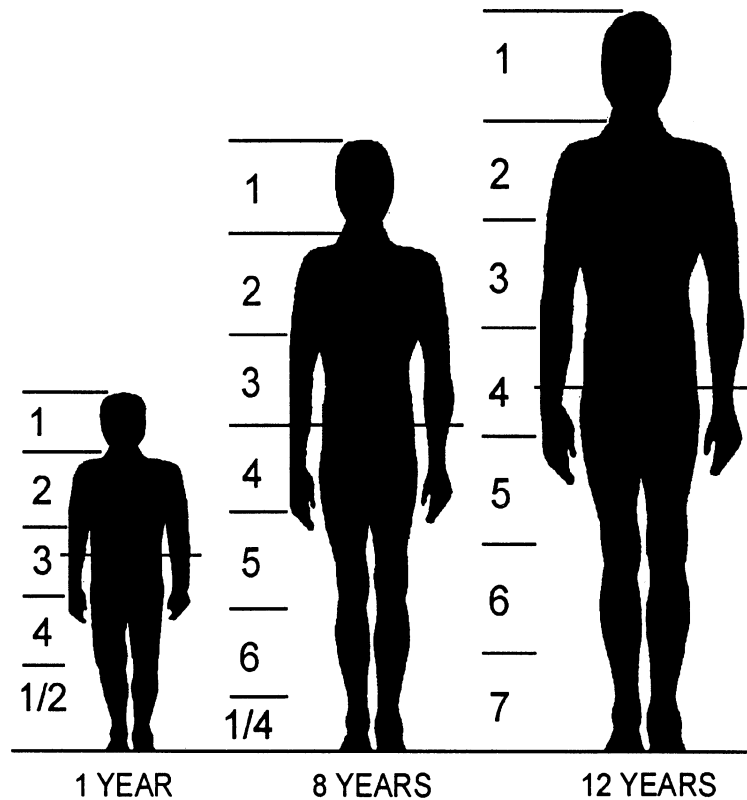

DMV30174

Figure 3-37.—The average height of a child at various ages.

Continued on next page

Figure Drawing, Continued

Foreshortening Foreshortening is the visible distortion in width and length of an object when viewed in perspective. An object slanting toward or away from the viewer seems to diminish in size and change shape. Keen observation and practice are keys to determining the amount of foreshortening required to realistically portray figures.

Figure 3-38 shows foreshortened cylinders.

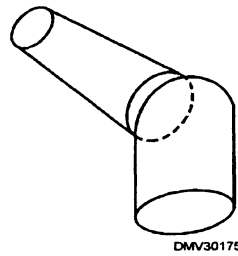

Figure 3-38.
—Foreshortened
cylinders.

Figure 3-39 shows a foreshortened arm.

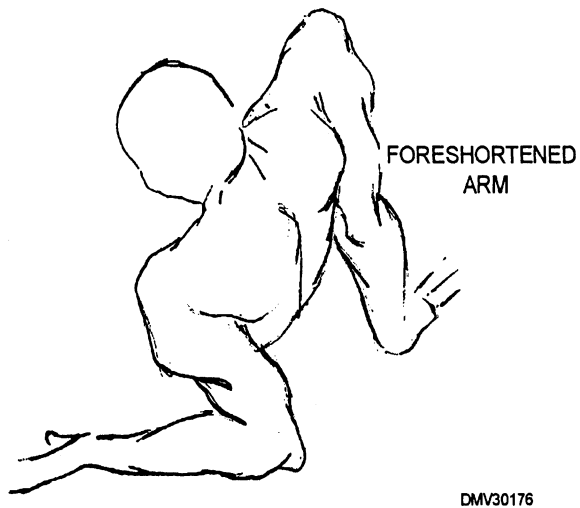

Figure 3-39.—Human figure with
foreshortened arm.

Figure Elements

Introduction

For simplicity in constructing the human figure, divide the figure into five elements. Approach each element as a task and reduce each task to basic forms. The five elements in figure construction are the torso, the arms, the legs, the hands and feet, and the head.

Torso

The torso, or upper body, is easily rendered as a modification of two cylinders or an inverted and truncated (cut off at the apex) cone. Two inverted cones may portray some body shapes better. Running along the center of the back, connecting the head to the neck and the neck to portions of the torso, is a flexible column that allows the torso to twist and bend.

Figure 3-40 shows cylinder and cone construction of torsos.

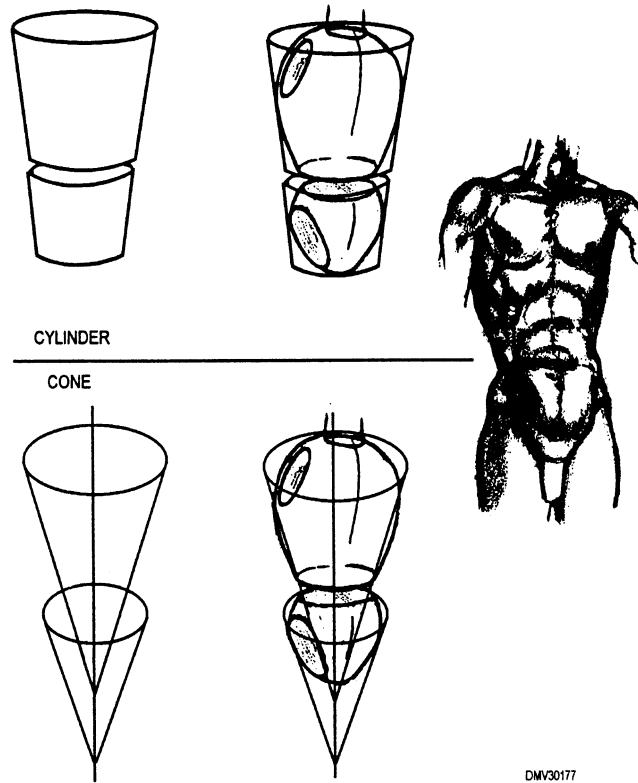

Figure 3-40.—Constructing a torso from cylinders and cones

Continued on next page

Figure Elements, Continued

Arms

The upper and lower arms are modified cylinders of approximately equal length. You may draw these cylinders at great angles in relation to each other because the arms bend and rotate. The arms attach to the torso by a ball-and-socket joint that allows rotation. The cylinders of the arms have a hinge joint that allows the forearm to bend forward.

Figure 3-41 shows the cylinders of the arms in various positions.

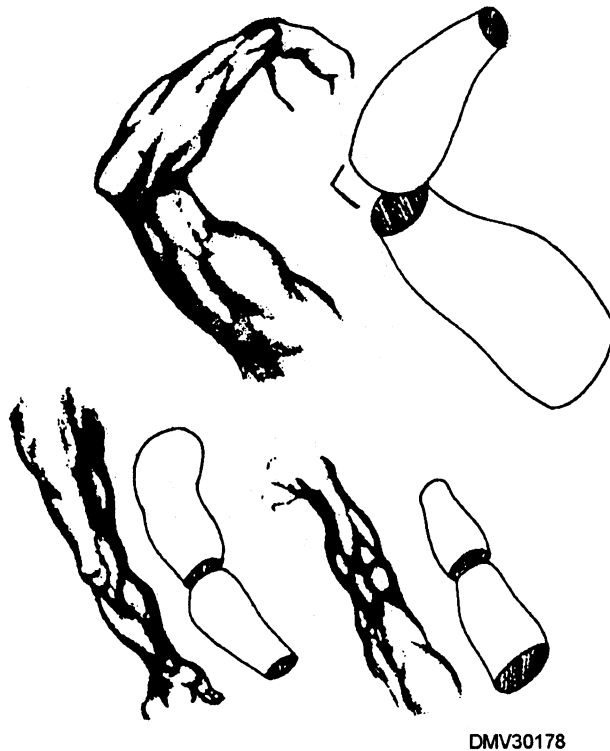

Figure 3-41.—The cylinders of the arm in various positions.

Continued on next page

Figure Elements, Continued

Legs

Legs, like arms, are modified cylinders of approximately equal length. Legs attach to the lower torso with a ball-and-socket joint for rotation. The cylinders of each leg are hinged to permit bending in a direction opposite that of the arms.

Figure 3-42 shows the cylindrical characteristics and hinge joint of the leg.

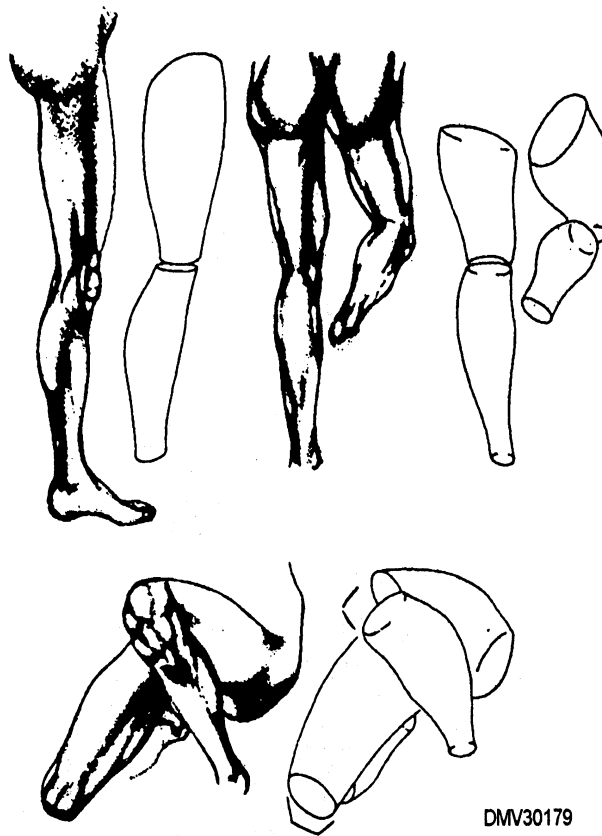

Figure 3-42.—The cylinders and joints of legs.

Continued on next page

Figure Elements, Continued

Hands and feet Hands and feet are each combinations of basic forms. Both the hands and feet attach to the cylinders of the lower arm and leg, respectively, with a compound rotary joint.. This joint allows rotation similar to that of a ball-and-socket joint.

HANDS: A cube and wedge (modified cube) represent the hand. The cube is the palm and the wedge is the mass of fingers. The cube and wedge are approximately equal in size. More detailed representation of the fingers is possible by using cylinders for the fingers.

Figure 3-43 shows a hand represented by a cube and a wedge, and a cube and cylinders.

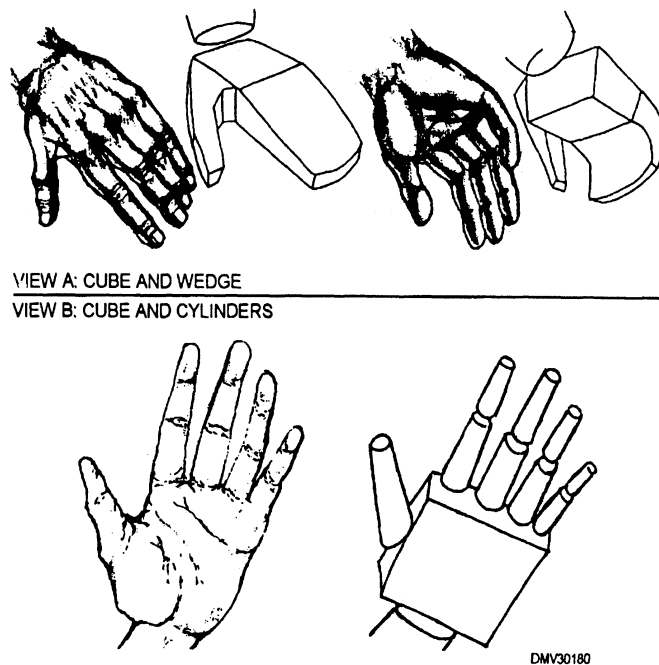

Figure 3-43.—A hand drawn with cubes and wedges (View A) and a cube and cylinders (View B).

Continued on next page

Figure Elements, Continued

Hands and feet (Continued)

FEET: A cone, a wedge, a sphere, and cylinders represent feet. The cone is truncated at the ankle. The sphere is the ball of the foot. A wedge represents the forefoot or arch of the foot and the cylinders are toes.

Figure 3-44 shows how a foot looks represented by basic forms.

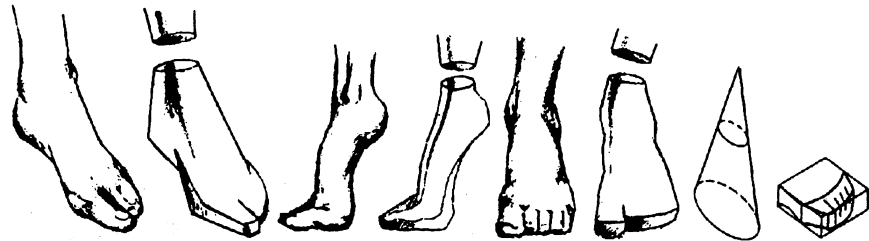

VIEW A: COMPLEX FORMS

VIEW B: BASIC FORMS

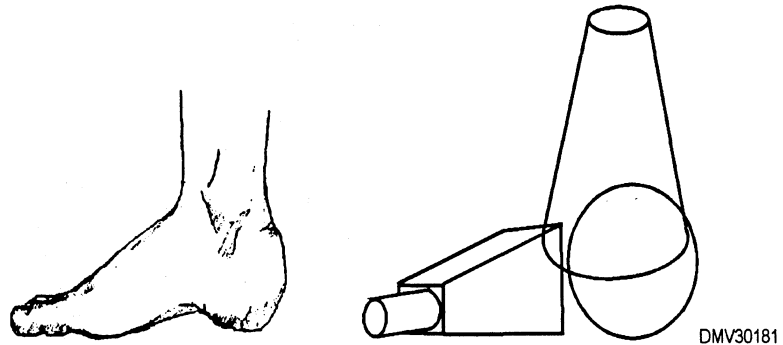

Figure 3-44.—Feet reduced to complex forms (View A) and basic forms (View B).

Continued on next page

Figure Elements, Continued

Head

The basic shape of the human head is a modified sphere, shaped very much like an egg. A short, thick cylinder drawn as wide as the lower portion of the head forms a neck to support the egg-shaped head. The head, the neck, and the torso attach to a flexible column or spine allowing rotation and up-and-down movement.

Figure 3-45 shows how the egg-shaped head appears on the cylindrical neck.

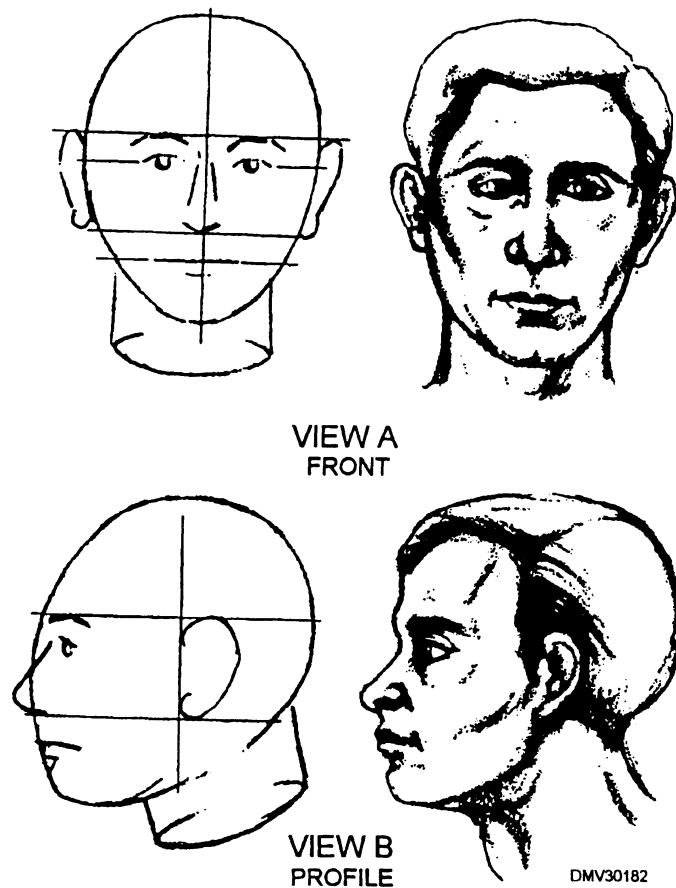

Figure 3-45.—The eggshaped head and cylindrical neck from the front (View A) and the profile view (View B).

Facial Features

Introduction The features of the head are often the most difficult to realistically portray. There is no substitute for constant practice and careful observation.

Location of the features Horizontal and vertical lines locate facial features on the head. To place features on a head, draw a vertical centerline and a horizontal centerline on the head. The vertical centerline positions the nose and mouth. The horizontal centerline locates the eyes and the top of the nose. Just above the horizontal centerline, draw a line to locate the eyebrows and the top of the ears. Draw another horizontal line midway between the horizontal centerline and the chin to find the bottom of the nose and ears. Just below this, draw a horizontal line to place the mouth.

Figure 3-46 shows the steps involved in placing facial features.

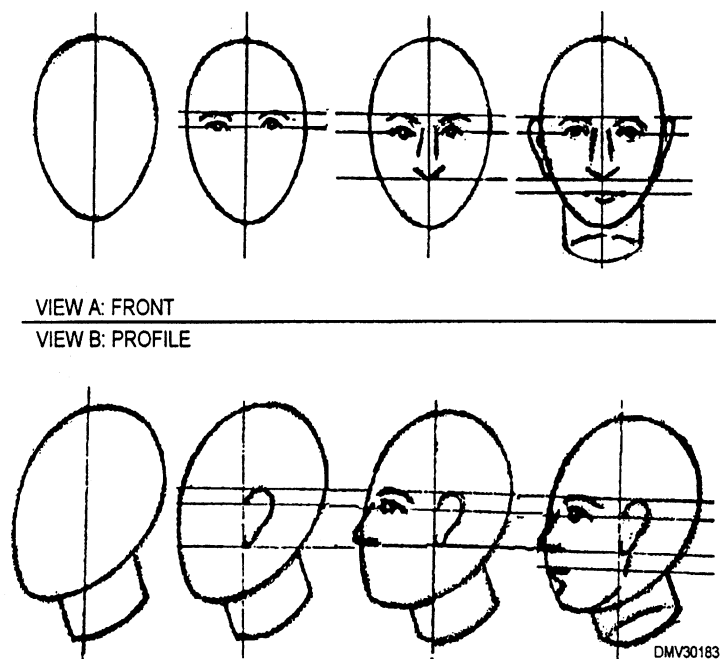

Figure 3-46.—Guidelines for placing facial features on the front (View A) and profile view (View B).

Continued on next page

Facial Features, Continued

Features in profile

Viewing the head in profile further defines facial features. Some features of the head appear to indent or protrude. In a side view, the ears are just back of the vertical centerline, the eyes are slightly indented, the nose projects, and the brow, mouth, and chin protrude from the basic egg-shaped skull. The bases of the nose, cheekbones, earlobes, and skull lie on a line across the head. For correct placement of features in a view of the head from different angles, use the technique of drawing through. As the vertical and horizontal guidelines rotate with the head, draw them as ellipses to retain the correct relationship of the features and the solid roundness of the head.

Figure 3-47 shows the head from different angles and the effect on the facial features.

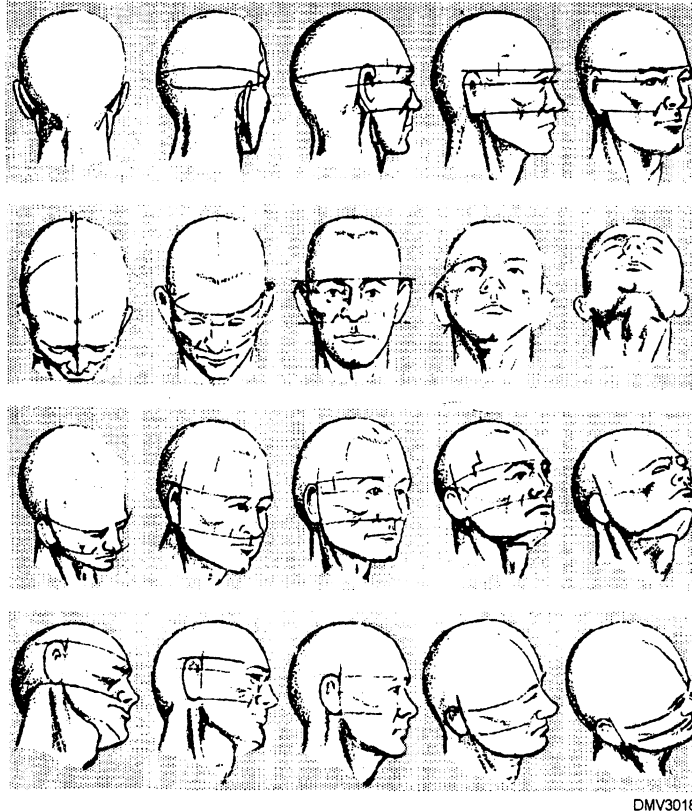

DMV30184

Figure 3-47.—The effect of turning the head to different angles on the placement of facial features.

Continued on next page

Facial Features, Continued

Feature proportions

As with figure proportions, using a standardized unit of measure helps to eliminate distortion. The unit of measure for correctly placing features on a head is the length horizontally across the eye.

To apportion the facial features on the head, use this table:

| Feature | Size |
|--------------------|---|
| Head (at the brow) | 4 eye lengths |
| Eyes | ½ eye length wide, 1 eye length long, 1 eye length apart |
| Nose | 1 eye length, parallel lines drawn down from the inside corners of the eyes locate the nostrils |
| Mouth | 2 eye lengths, comers of the mouth should be directly under the center of the eyes |

Figure 3-48 shows important check-points for the placement of facial features.

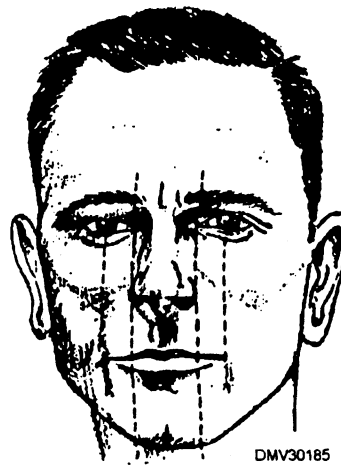

Figure 3-48.—Facial feature checkpoints.

Continued on next page

Facial Features, Continued

Eyes

The eyes are one of the most expressive features of the face. The eyeball itself is round. Two eye lids curve around the eyeball. Both lids have lashes, but are completely different in design at the inner and outer corners. At the outer corner, the upper lid overhangs the lower lid. At the inner corner, the lids do not touch. When the eye is open, a pinkish membrane separates the lids. The eye in profile slants downward and inward from the forehead to the cheekbone. The exposed part of the eye is always moist. The moisture reflects light and causes a distinct highlight. The location of the highlight depends on the direction of the light and is an important factor in making your drawing appear lifelike.

Figure 3-49 shows drawings of eyes.



Figure 3-49.—Drawings of eyes.

Continued on next page

Facial Features, Continued

Nose

The nose is narrow at the top and wide at the bottom. The upper ridge of the nose is bony. The lower half of the nose consists of five pieces of flexible cartilage responsive to the actions of the facial muscles. The cartilage that forms the hook of the nose is between, and extends slightly below, the nostrils. Nostril cavities are generally triangular shaped and slant outward toward the back of the nose.

Figure 3-50 shows several drawings of different noses.

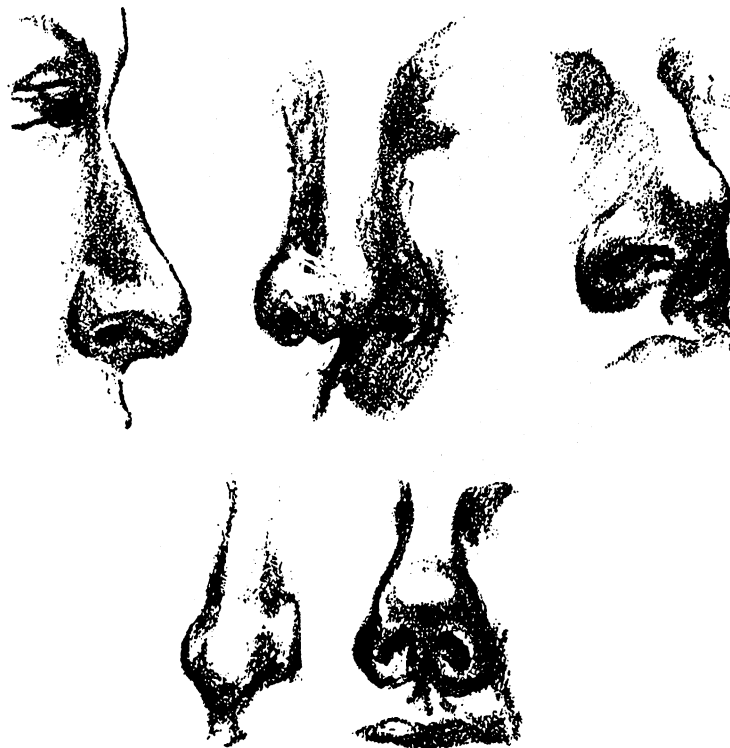

DMV30187

Figure 3-50.—Several drawings of noses.

Continued on next page

Facial Features, Continued

Mouth and chin The mouth, like the eyes, is very expressive. The upper lip is thickest in the center and thins downward to the corners. The upper lip is flat and angular compared to the lower lip which is more rounded. When the mouth closes, the center section of the upper lip thrusts forward and rests in the center of the lower lip. The lower lip rests under the upper lip. When seen in profile, the lips slope backward from near the top of the nose to the furrow at the top of the chin. A slight depression forms when the corners of the mouth meet the lower cheek. This depression is usually more pronounced in male faces. In a smile or laugh, the corners of the mouth pull back drawing the upper lip taut and curving the lower lip upwards. The upper teeth are normally visible during a smile. Rarely are the lower teeth seen except in extreme actions of the mouth. The chin bulges forward at the center. The shape of the chin usually matches the character of the rest of the face.

Figure 3-51 shows mouth and chin combinations.

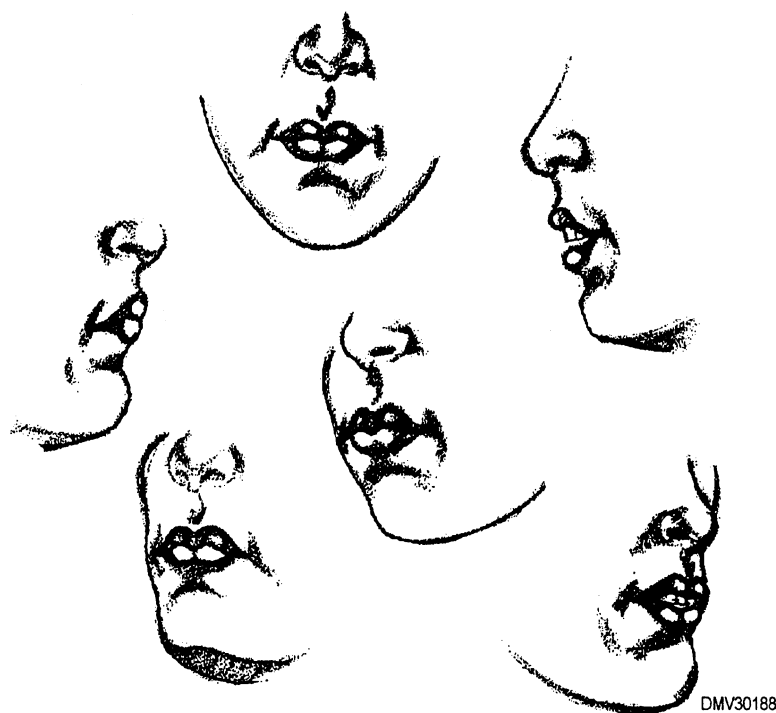

Figure 3-51.—Mouth and chin combinations.

Continued on next page

Facial Features, Continued

Ears

The ears are a mass of soft cartilage and flesh. They are wide at the top and narrow at the bottom, terminating in a fleshy lobe. The middle of the ear is bowl-shaped and surrounded by whorls and curves of flesh-covered cartilage. The four major shapes of the ear are the outer rim, the inner rim, the bowl area, and the lobe.

Figure 3-52 shows the four major shapes of an ear.

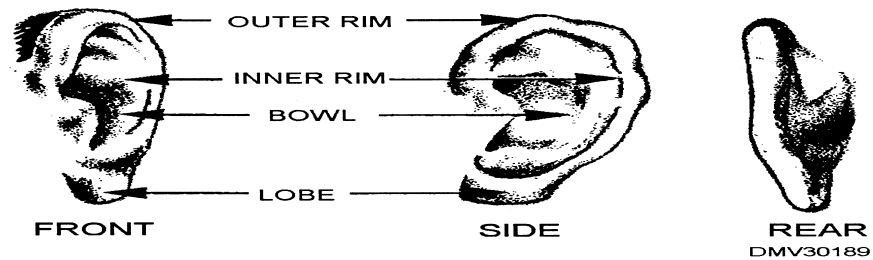

Figure 3-52.—The shape of ears in three perspectives.

Rendering Techniques for Figure Drawing

Introduction

At this point you have drawn a proportional figure that displays height, width, and length. Areas of mass and weight appear in substructure. Portraying the effects of light and shadow, and adding clothing to the figure adds to the realism of the drawing.

Light and shadow

Add light and shadow areas as you would for any of the other basic shapes. Locate the light source and make highlights and cast shadows consistent with it. Remember, the musculature under the skin layers interrupts light and creates shadows of its own. This is particularly true with well-defined musculature and dynamic posturing or figures in extreme actions.

Figure 3-53 shows shadows cast by well-defined musculature.

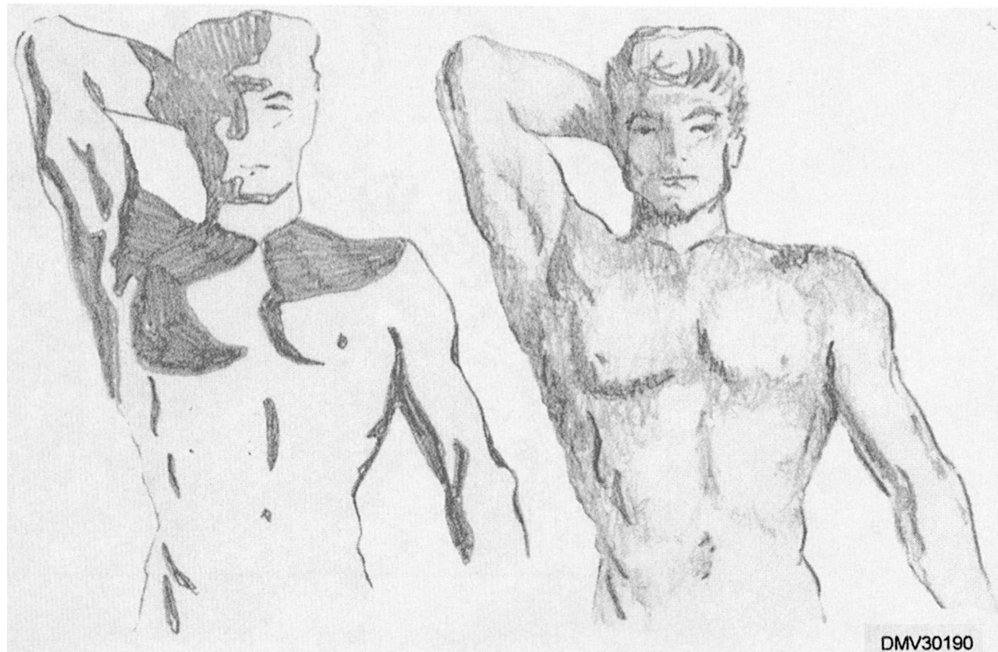

Figure 3-53.—Shadow areas cast by well-defined musculature.

Continued on next page

Rendering Techniques for Figure Drawing, Continued

Clothing

How successfully you draw the folds of clothing on a figure has a great deal to do with how realistic your drawings appear. Clothing on a figure does not change in amount but, condenses. Condensed cloth creates folds in different shapes and in different places. The shapes, place, and direction the folds take is determined by gravity, tension, and action.

Gravity folds

Shoulders for the coat, shirt, blouse, and the waist for the skirt and trousers form gravity folds. The coat, supported by the shoulders, hangs free at the waist. The action of the arms, and whether the coat is buttoned or unbuttoned, determine how and where the folds appear.

Figure 3-54 shows the folds of a buttoned and unbuttoned coat.

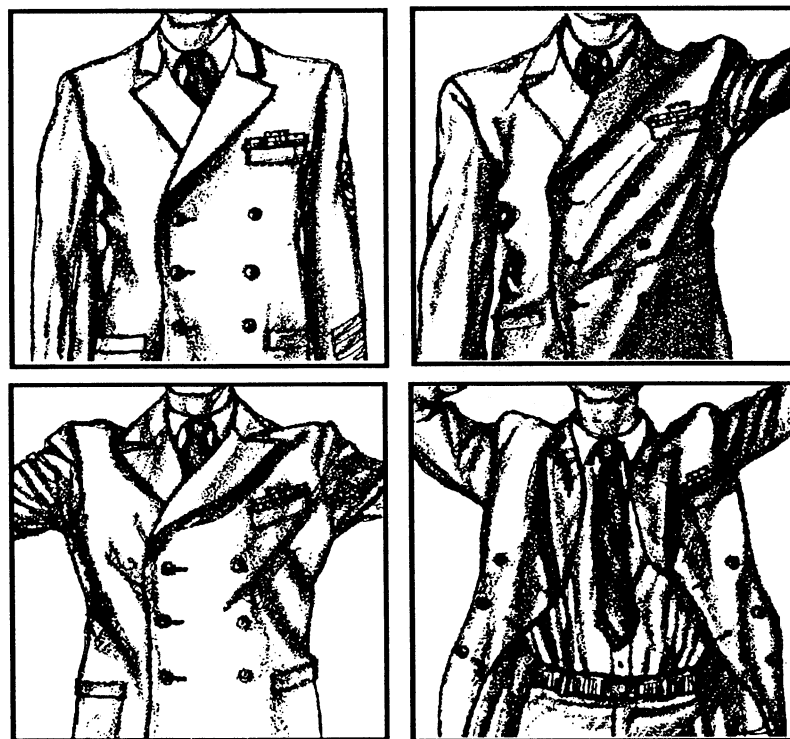

DMV30191

Figure 3-54.—Four examples of folds in a coat.

Continued on next page

Rendering Techniques, Continued

Gravity folds (Continued)

Shirts and blouses are supported at the shoulders, but are drawn tight at the waist. A variety of folds radiate from the waist to the shoulders. Body posture also effects how folds appear. Shirts and blouses worn by women have additional support from the bust line. Notice that most folds on the sleeves occur on the upper side of the arm at the elbow.

Figure 3-55 shows folds in shirts.

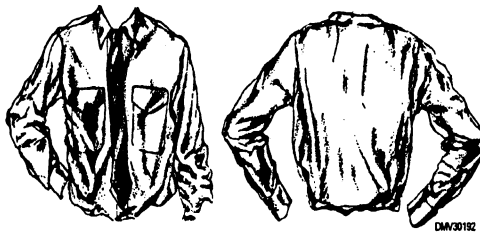

Figure 3-55.—Two perspectives showing folds in shirts.

Figure 3-56 shows the folds in women's blouses.

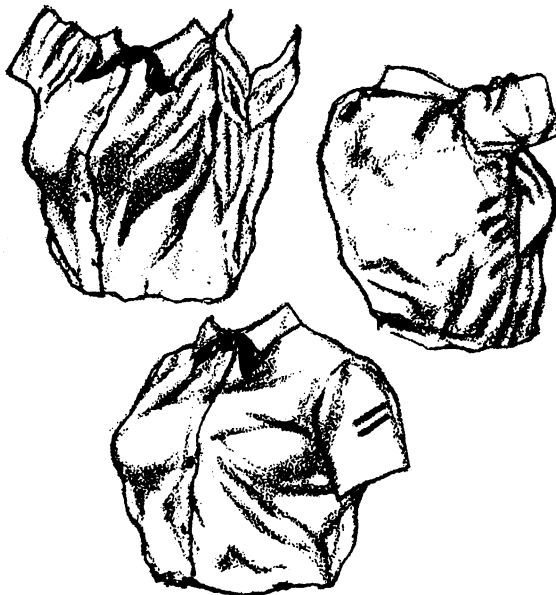

Figure 3-56.—Three perspectives showing folds in blouses.

Continued on next page

Rendering Techniques, Continued

Gravity folds (Continued)

The waist and hips support skirts and trousers. The bottom of the skirt hangs free. The design of a woman's skirt is sometimes restrictive and when movement reaches the limits of the material, strong lines of tension appear. Trousers hang free but, because of their closeness to the body, they are greatly affected by tension and action.

Figure 3-57 shows folds in skirts.

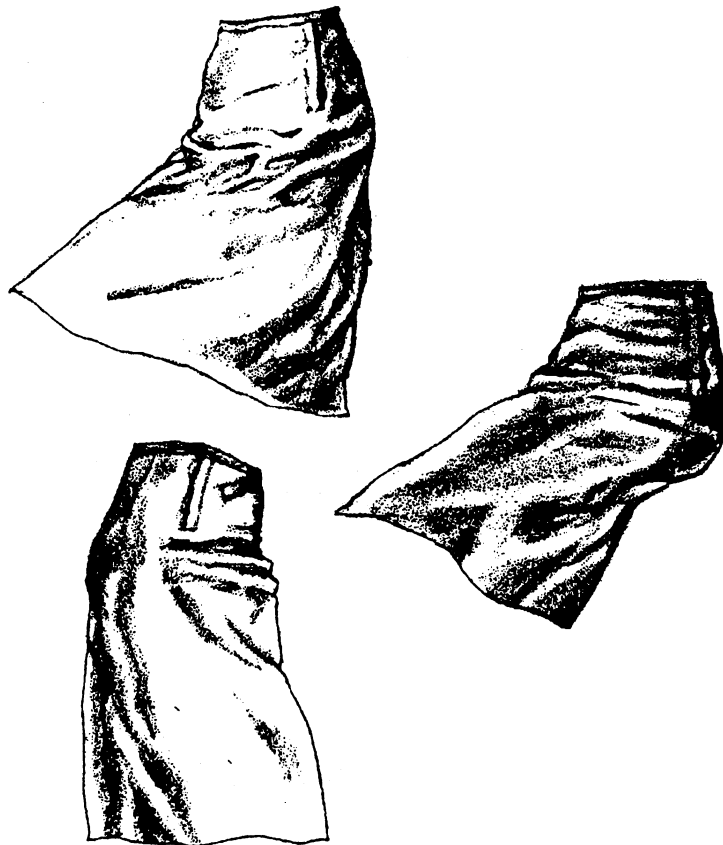

DMV30194

Figure 3-57.—Three perspectives showing folds in skirts.

Continued on next page

Rendering Techniques, Continued

Tension folds

Folds formed by tension are at the 'shoulder-arm junction, the elbow, the waist, the leg-torso junction, and the knee. Although trousers are supported at the waist, they display a significant amount of tension folds at the waist, the crotch, and the knee. Notice that some of the folds terminate at the seam of the pantleg which act like a point of support.

Figure 3-58 shows folds in pairs of trousers.

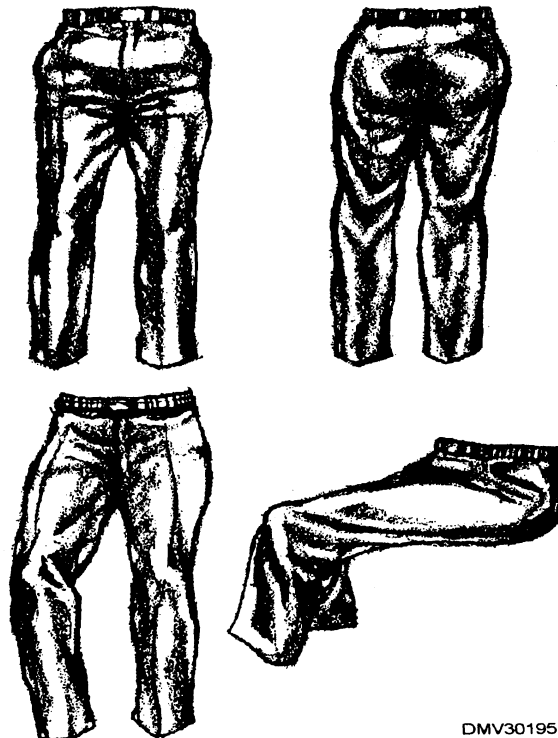

DMV30195

Figure 3-58.—Four perspectives showing folds in trousers.

Action folds

When the arm, the torso, or the leg bends or changes direction, the cloth slackens on the opposite side of the tension. Folds become strongly directional. Buttons may interrupt folds and create folds of their own. As tension or action increases, folds become tighter.

Expression

Introduction

Your drawings communicate by images alone. Use expression and gestures to imply emotions. Specific positions or changes in body posture emote feelings. Use directional lines to imply relationships and increase communications between figure elements.

Posturing

The human figure is constantly changing shape. The carriage or posture the body assumes when it changes, shape implies moods or feelings. Typically, a emaciated figure evokes weariness. A figure drawn with lines that appear uplifting portrays happiness or joy. The mood you attempt to capture in your drawing should be the one that best conveys your idea or emotional message to the intended audience.

Figure 3-59 shows methods of conveying five typical moods.

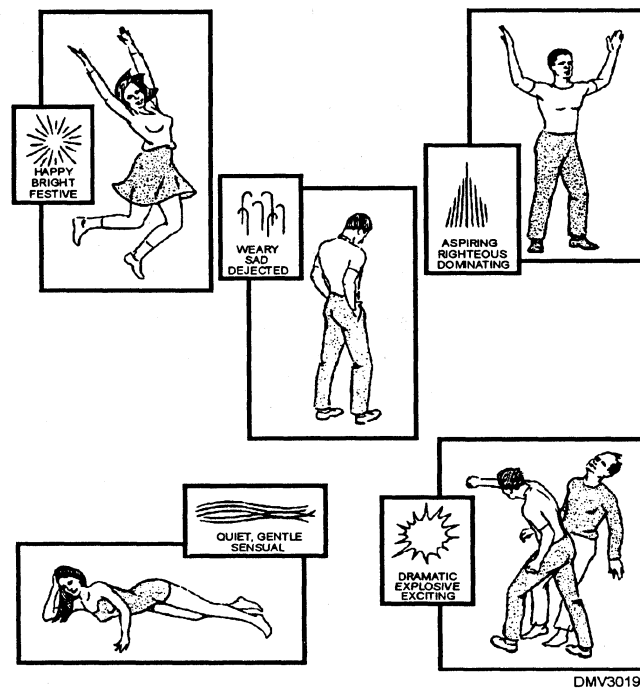

Figure 3-59.—Five typical moods.

Continued on next page

Expression, Continued

Directional lines

Directional lines are invisible lines that guide the eyes through the picture to a conclusion. Directional lines keep the viewer in the picture or lead the viewer out of the picture. Two figures placed facing each other look as if they are responsive to each other, perhaps conversing. If two figures are looking in the same direction, they appear to be looking at the same scene. Two figures looking in opposite directions may imply tension or aloofness.

Figure 3-60 shows how differently two figures may relate to each other and direct the viewer's attention.

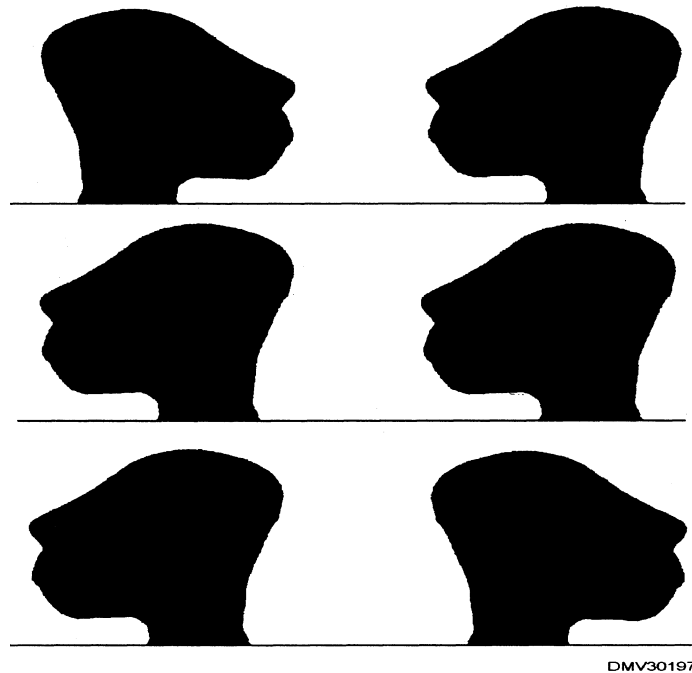

Figure 3-60.—How two figures relate to each other.

Settings

Introduction

Settings should compliment the figures you place in your pictures. Choose settings that help explain and strengthen the actions of the figures. Select a view for your picture that is clear and effectively communicates a meaningful statement about the feelings of the people shown.

Borders

Surrounding a picture is a border. Your placement of figures and objects should convince the viewer that the picture is part of the real world. Borders may confuse the viewer by partially obscuring figures. Figures placed near borders draw the attention of the viewer out of the picture. You can place figures facing inward from the border and still maintain viewer interest. Figures that face borders and gesture toward them also lead the viewer outside the picture area.

Figure 3-61 shows how the placement of figures inside a border areas affects viewer attention.

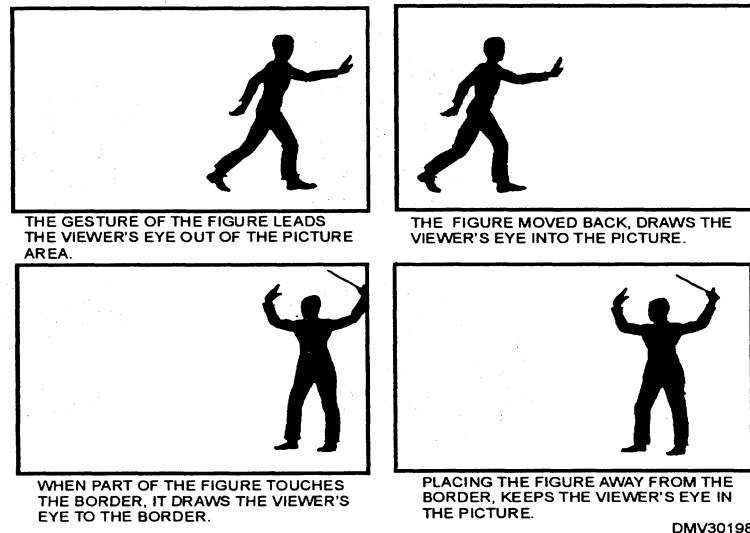

Figure 3-61.—How figures effect picture borders.

Continued on next page

Settings, Continued

Background

Images in the background may help clarify a picture or the action of the picture's figures. The background may serve to geographically locate figures. For instance, a combat corpsman looks very different in a nondescript jungle setting than with the Arc d'Triumph in the background. The two different backgrounds imply a time span of 30 years.

Figure 3-62 illustrates how background settings influence the perceptions of the viewer.

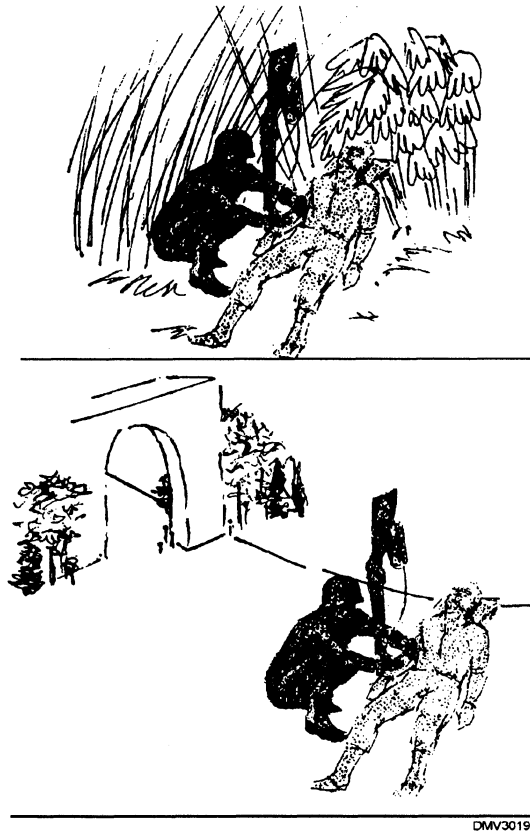

Figure 3-62.—Background settings influence the viewer.

Continued on next page

Settings, Continued

Perspective

Viewers automatically relate the proportion, the scale, and the size of objects to figures in the picture. Select the main figure in the picture and scale all other figures and objects to this main figure.

Figure 3-63 shows objects scaled to a main figure.

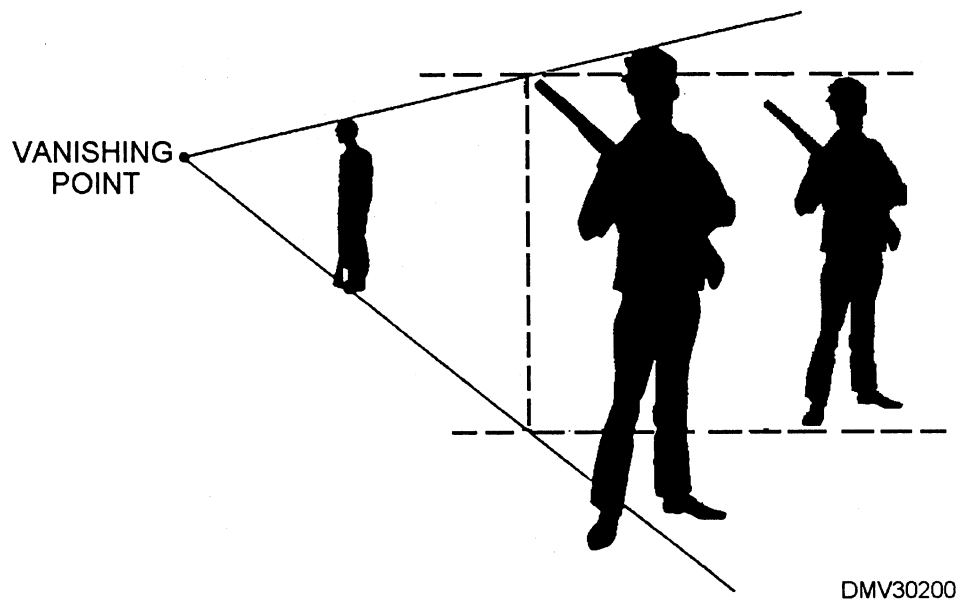

Figure 3-63.—Scaling objects to a human figure.

Continued on next page

Settings, Continued

Crowds

Whether you are composing one or two figures in an illustration or arranging a whole crowd of people, the same principles of figure drawing apply. A crowd, like an individual, may express any emotion. A crowd is never expressionless. A large group of people must always express some mood or feeling.

Figure 3-64 is a crowd of people expressing an emotion.



Figure 3-64.—A crowd of people express emotion.

Summary

Review

This chapter covers basic drawing techniques. It briefly outlines techniques designed to help you advance in figure drawing. The different types of contour drawing, gesture drawing, and composite drawings, when practiced regularly, will develop your perceptual skills required to draw realistic images.

Comments

Some believe the ability to draw well is a developed skill, others believe it is a gift or inborn talent. Even with advent of computer-generated graphics, the ability to draw well remains an invaluable skill. Drawing well is a talent computers can not emulate. Computers depend on the input of the system operator for compositional formulas, imagination, and creativity. The knowledge of composition, and the foresight to envision the end product are yours. Practice and develop your drawing ability. You will simultaneously develop compositional savvy and spark previously unrealized imaginative and creative resources.

CHAPTER 4

CARTOONING AND ANIMATION

Overview

Introduction Cartoons are natural attention getters. The ability to draw cartoons and animated images is important to the Illustrator Draftsman. You will often be asked to create cartoons for command functions or presentations.

Objectives The material in this chapter enables you to do the following:

- Translate emotions into typecast facial features.
- Match background props to cartoon styles.
- Exaggerate dominant facial features, expressions, or gestures to create caricatures.
- Use the standard television aspect ratio when creating animation.
- Calculate the required number of frames to create animation that runs smoothly.
- Differentiate between animation and video graphics presentations.

Continued on next page

Overview, Continued

In this chapter This chapter covers the following topics:

| Topic | See Page |
|-------------------------|-----------------|
| Cartoons | 4-3 |
| Caricature | 4-8 |
| Animation | 4-9 |
| Basic Equipment | 4-15 |
| Elemental Construction | 4-17 |
| Incidental Construction | 4-41 |
| Technique | 4-45 |

Cartoons

Introduction

There is a long history of the use of cartoons in the military. During World War II, popular cartoon characters adorned aircraft fuselages as nose art and squadrons patches identified squadrons and their missions. More recently, Half Hitch, a cartoon Sailor, and Grampa Pettibone, an old chief safety supervisor, appeared in Navy magazines. Cartoons are commonly found on safety posters and in some training manuals such as this one and the manual on *The Metric System*.

Advantages of cartoons

Cartoons are natural attention getters and hold viewer's attention long enough to deliver short messages. They liven up dreary subjects. Cartoons emphasize security and safety, 'add interest to training and briefing material, and promote recruiting and retention. Use a cartoon to subdue real tragedies that would normally frighten or repulse.

Figure 4-1 shows a cartoon safety poster depicting a real hazard and a potential tragedy.

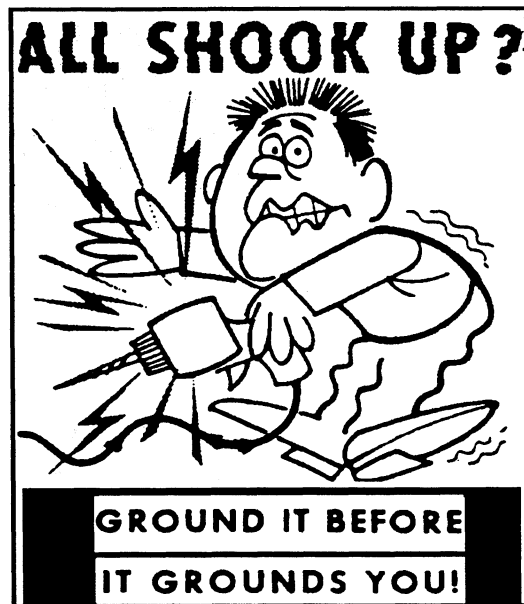

DMV30202

Figure 4-1.—A safety poster depicting a real hazard and a potential tragedy.

Continued on next page

Cartoons, Continued

Cartoons Cartoons are drawings depicting people and events in situations too dangerous, undesirable, impractical, or cruel to place humans. Cartoons are usually one panel or one image in size. The two forms of cartooning are the semi-realistic and the exaggerated.

Semi-realistic cartoons Semi-realistic cartoons are drawings where emphasis is on realism. The illustrations resemble line drawings. Exaggerations are slight and standard figure proportions are used. The danger in semi-realistic cartooning is that incorrect figure proportions or perspective negatively affect the impact of the cartoon by focusing attention on the incorrect proportion rather than the intended message.

Figure 4-2 shows an example of a semi-realistic cartoon.



DMV30203

Figure 4-2.—A semi-realistic cartoon head.

Continued on next page

Cartoons, Continued

Exaggerated cartoons

Exaggerated cartoons are drawings emphasizing and exaggerating facial features, body parts, speech patterns, demeanor, dress, or situations. Exaggerated cartoons are the types of cartoons with which you are most familiar. With exaggerated cartoons there is greater latitude for inaccurate proportions or perspectives as this can be attributed to personal style. Do not mix semi-realistic and exaggerated cartoons in the same picture or the cartoon will not seem believable.

Figure 4-3 shows how exaggerated cartoon images may become.



DMV30204

Figure 4-3.—Exaggerated cartoon figures.

Continued on next page

Cartoons, Continued

Cartoon strips Cartoon strips are a series of cartoons that show logical or storyboard progression. Each singular cartoon drawn in a strip is called a panel. Several panels, side-by-side, tell a story or make a point. The cartoon panels read from left to right. Cartoon strips appear in static form such as newspapers, magazines, and books.

Figure 4-4 shows a series of cartoon panels called a cartoon strip.

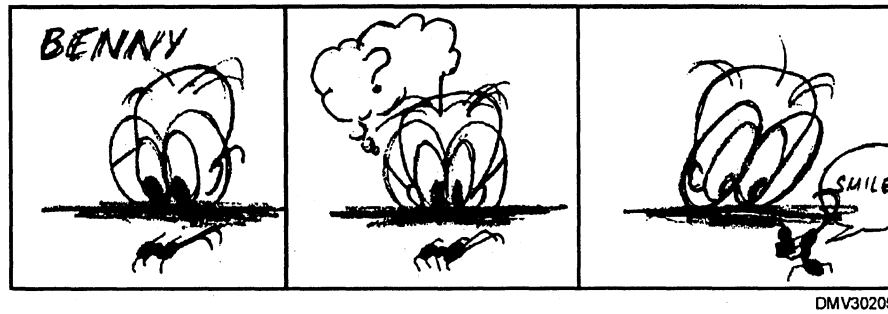

Figure 4-4.—A cartoon strip.

Continued on next page

Cartoons, Continued

Balloons

Cartoon strips use images and words to tell a story. In cartooning, balloons encase the words or thoughts of cartoon characters. The two types of balloons are: (1) the solidly drawn speech balloons with carot leading to the speaker, and (2) the cloud-like thought balloon using little round puffs leading to the thinker.

Figure 4-5 shows an example of a speech balloon and a thought balloon.

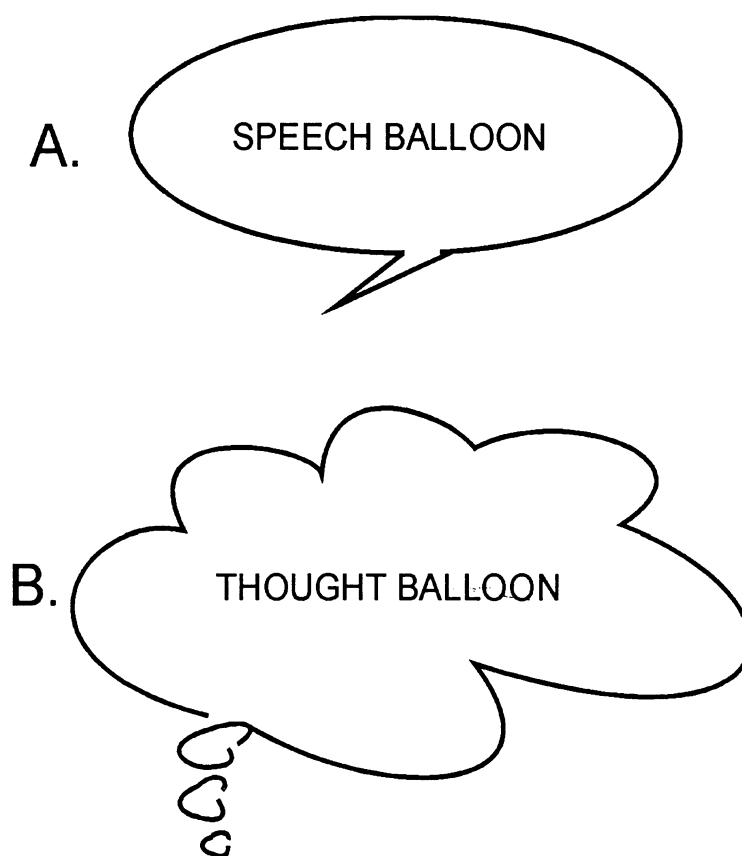

DMV30206

Figure 4-5.—Examples of balloons used in cartoons: A. Speech balloon; B. Thought balloon.

Caricature

Introduction

Caricature is one of the most popular forms of poking fun (known as *roasting* when targeting individuals). Accurate caricatures may say more about individuals than words on paper to readily and immediately communicate messages on personalities. A talented DM, well versed in caricature creation, is always busy in a command.

Caricature

Caricatures are cartoons primarily emphasizing an individual's prominent facial features, hair, demeanor, personality, or attitude. Caricatures may be humorous, severe, or sinister. When creating a caricature, think about what strikes you most about the individual. Exaggerate the feature which stands out from all the others.

Figure 4-6 shows examples of caricatures.

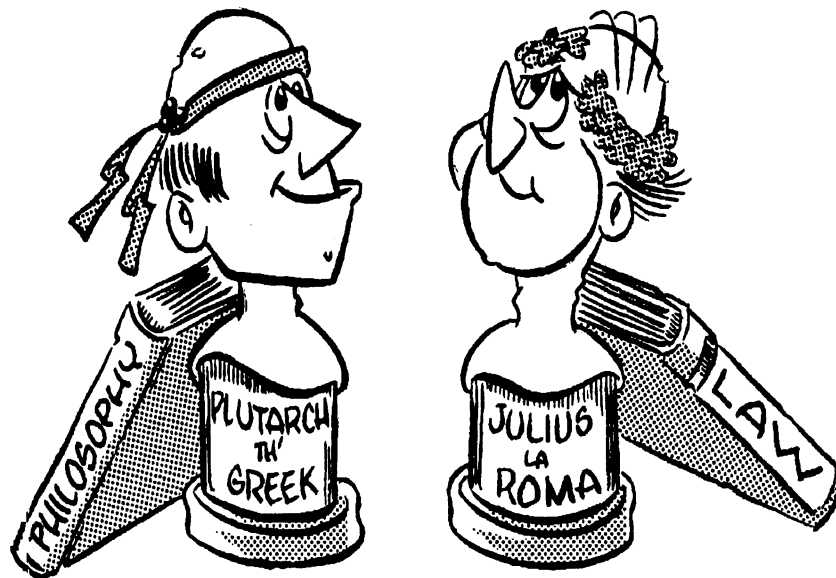

DMV30207

Figure 4-6.—Caricatures.

Animation

Introduction

Animation, imparting motion to otherwise static imagery, is gaining popularity in use in more applications than mere entertainment. The training community is starting to appreciate the versatility of animation as a teaching medium. Animation, once costly and time consuming, has become computerized and cost effective. For more information on animation, study the Kodak book, “*The World of Animation*” and books about Walt Disney and the Disney Studios.

Animation

Animation is cartoons or images put in motion. Similar to cartoons and cartoon strips, animation is first drawn or assembled as individual panels displaying a range of action. Viewed in rapid succession, the range of action becomes motion. Animation requires more cartoon illustrations than cartoon strips.

Pre-animation requirements

Before beginning the long process of animation, select a topic and develop a story line. Create a script for the story and lay out the sequence of events in the story in cartoons captioned with the words of the script. Normally, an originator requesting animation provides the story line and script. Your job is to illustrate and animate it.

Animation techniques

You may use photography, acetate sheets called *cels*, three-dimensional material, slides, or computers to create animation. The aspect ratio of art created for animation is 3 units high by 4 units wide. This is the same format used in television graphics.

PHOTOGRAPHY: Photographically created animation, sometimes called photoanimation, is a photographic sequence of standard photographic prints. Motion is implied by dissolving from one photo to another, fading in or out of focus, or segmentally dividing one image and displaying it sequentially. For example, documentaries often link still photos together to portray a time when movie film footage is not available, such as the Civil War.

CELS: Cel animation is the conventional method of animation. Artwork, transferred to acetate sheets (*cels*) and colored (inked) from behind, is placed on background art and shot on motion picture film or slide film. Cel animation, or a variation of it is commonly used in Navy graphics shops.

Continued on next page

Animation, Continued

Animation techniques (Continued)

THREE-DIMENSIONAL MATERIAL: Three-dimensional material used for animation refers to objects such as clay figures, puppets, or cutouts placed into the image areas and shot individually. The most popular three-dimensional medium used today is clay. Using clay for animation is called claymation.

SLIDES: Slide animation uses slides and slide projectors to portray motion and requires a slide programmer that can process at least 20 slides per second. The rapid projection of slides imitates the motion picture projector.

COMPUTER: Animation software programs offer limitless creativity and the ability to manipulate cartoons. Software programs can roll, twist, undulate, and color images. Some software programs allow a more detailed manipulation of parts by providing different mouth shapes to program for lip synchronization of sound.

Model sheets

After becoming thoroughly familiar with the text, develop character studies for each character in the production by drawing each character in multiple views and many positions on one sheet of drawing paper. This process develops the personality and expressions of the character and maintains consistency in character portrayal. Do this for each character in the animated film. The resulting drawing for each character is called a model sheet.

Continued on next page

Animation, Continued

Model sheets
(Continued)

Figure 4-7 shows an example of a model sheet.

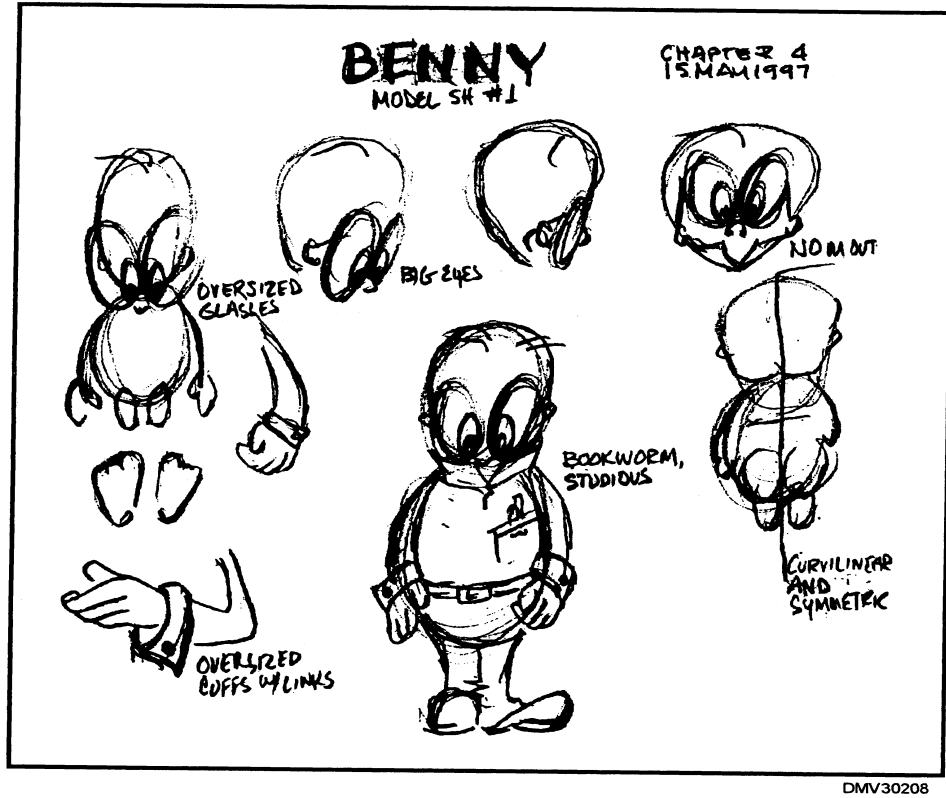

Figure 4-7.—A model sheet.

Continued on next page

Animation, Continued

Spacing guides The extreme parameters in a range of action performed by the characters and the amount of time allotted to complete each movement are laid out on paper and called spacing guides. Time translates into how many seconds at how many frames per second are required to complete the action from beginning to end. For a smooth transition in action sequences, make one drawing per frame. In action sequences of uncomplicated motion, you may draw every other frame. For example, a 3 second movement filmed at 16 frames per second requires 39 drawings to complete. Of the 39, approximately 19 drawings will display simple movement with little jerky action. Extended movements require more time, and therefore, more drawings than short movements. Once you determine the length of time to complete a movement, draw the key positions for the range of action.

Figure 4-8 shows how to compute the number of drawings required to complete a simple movement of a clock pendulum.

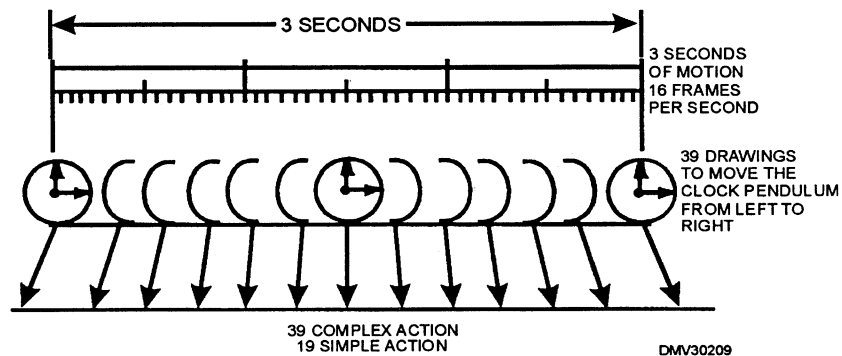

Figure 4-8.—Calculating the number of drawings required to complete an action.

Continued on next page

Animation, Continued

Range of action The range of action is defined as one extreme position to the final extreme position. Some animation sequences achieve the illusion of motion by first illustrating the extremes then, drawing the positions in between the extremes to complete the range of action. By drawing the extreme positions first, you can determine the amount of image area the character requires to move and the characters relationship to other characters and objects in the image.

Figure 4-9 shows extreme positions of the arm. The drawings in between the extremes help to smooth and define the range of action.

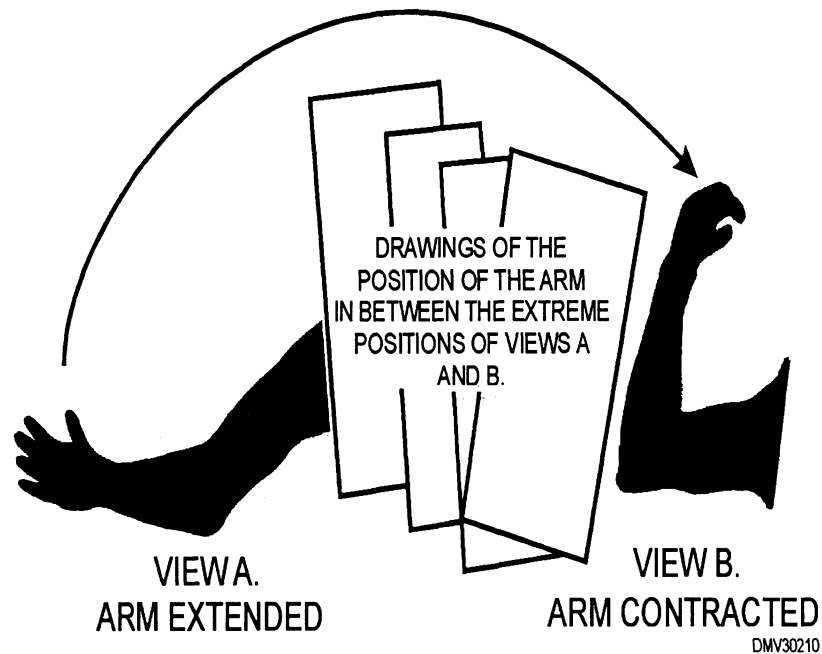

Figure 4-9.—Drawings requires to show a range of action made by an arm: A. Arm extended; B. Arm contracted.

Continued on next page

Animation, Continued

Flipping Flipping is the process of rapidly flipping through the completed drawings in rapid succession to make sure that action flows smoothly. Gather copies of original drawings, correctly sequenced, and rapidly leaf through them. If you notice jerky or unnatural movement, indicate corrections on the copies. Correct the original drawings after character movement on the copies appears to flow.

Creating the cel Creating the cel from the original artwork requires copying the art, either photographically, electronically, or by diazo onto a clear acetate base. The image should appear on the clear acetate base as a black line image.

Coloring the cel Because cels are acetate based, inks, oil, and acrylic paints will not adhere to them. Use specially formulated color paints, available in many colors, to paint on the cel. These paints are flexible and will not crack off when dry. Paint the reverse side of the cel (when the image is backward to you) and paint within the lines. Thoroughly mix paints before applying them to the cel or streaks may appear when viewed from the front side. Allow extra drying time for acetate-based paints to dry. Acetate-based paints dry slowly and may dissolve previous paint layers if they are not dry before you apply the next color. Use permanent markers to color acetate when you want to exaggerate texture and streak marks.

Photographing the cel Once painted, place the cel on prepared background images or textures and photograph with standard slide film. Be aware of the potential effects of glare from the camera lights. Finished slides may be shown in standard slide projectors, slide projectors equipped with a programmer (programmed up to 20 frame per second), or fed into computers.

Computer-generated animation Several animation software programs exist to greatly simplify creating animation graphics. The theory of animation remains unchanged. You still define the extreme range of action the character is to make, determine the amount of time to begin and complete the action, and translate time to frames per second. This is the number of separate images required to portray the action. You must draw the images at the beginning and end of the action sequence. The computer software draws the images in between the extremes.

Basic Equipment

Introduction

The equipment requirements to draw cartoons, cartoon strips, caricatures, and animation is similar. Most of this is standard equipment found in Navy drafting or graphics shops.

Equipment

The cartoonist's equipment is simple and each illustrator may have his or her own favorite tools. The following basic list does not include all the equipment you may prefer. Be flexible in your selection of tools and experiment with different products.

DRAWING BOARD: A drawing board (18-by-24 inches) small enough to tilt or turn will permit you to work on your cartoons at any angle.

T-SQUARE: Use a t-square in the layout of the cartoon.

TRIANGLE: Use triangles to draw vertical lines.

MASKING TAPE: A small roll of masking tape (approximately 1/4 inch wide) will hold paper to the drawing board securely.

RULER: Rulers help maintain straight lines and you may use them to guide brush strokes.

INK: Use black, waterproof ink, particularly if you are reproducing the cartoon.

OPAQUE WHITE: Opaque white covers inking errors.

PENCILS: Select sky blue pencils for drawing nonreproducible guidelines, general sketching, and layout. Very soft, dense black pencils blacken the reverse of images for transfer to another substrate. Dense, black-leaded pencils also create graded and halftone effects on rough surfaced papers. Choose brick red pencils for making notes to the printer on overlays.

ERASERS: For areas that are difficult to erase, use hard rubber erasers. Soft erasers work well for general-purpose work and art gum or kneaded erasers highlight and perform final clean-up chores.

Continued on next page

Basic Equipment, Continued

Equipment (Continued)

PENS: For hand lettering, round-nibbed pens create letters for cartoons.

BRUSHES: Watercolor brushes, particularly large and small red sables, allow versatility in inking and wash techniques.

BRISTOL BOARD: Two- or three-ply bristol boards work well for cartooning. Use plate finishes for pen and ink illustrations and kid finishes for brush and ink illustrations.

COQUILLE BOARD: Coquille board produces a rough or stipple pattern for graded and halftone effects.

In addition to tools and equipment listed above, cartoonists routinely use other media. Experiment with pastels, colored pencils, crayons, and watercolor. When working in color, use acrylic spray fixatives to keep colors from smudging, fading, or running.

Additional equipment

Two other items cartoonists keep close at hand are water and towels.

WATER: Cartoonists may keep up to four jars of clean water nearby. One jar of water is used to wash out ink-filled pens and brushes. One jar of water washes out brushes used with opaque white and thins the consistency of opaque white. The third jar of water flushes colored ink from brushes. And the fourth jar of water acts as a vehicle and reducing agent in watercolor.

TOWELS: Keep lint-free cloths nearby to wipe dry pen points, brushes, and tools when they become soiled or require washing.

Practice

No special tool substitutes for practice. Fancy pens will not disguise poor lettering. No amount of color or wash will improve bad composition. You must practice. **PRACTICE! PRACTICE! PRACTICE!**

Elemental Construction

Introduction

Cartooning and caricature drawing are supreme exercises for hand and eye coordination. Caricatures require astute observational skills and hand and eye coordination because cartooning and caricature are done freehand. Practice cannot be overemphasized.

Elemental construction

Elemental construction of cartoon figures involves the action lines, creating the head, adding features to the head, and drawing body parts. Consider the whole cartoon figure and the action that figure is to take. Begin with a foundation that clearly states the action required of the figure and work your way through the cartoon by drawing the head first, then arms, legs, upper torso, and lower torso.

Foundation

The foundation of cartoon figures starts with the construction of action lines. Determine the action that best represents the message or information you wish to convey. Use stick-figure construction or the action line method to frame the action and activity of the figure.

Figure 4-10 shows stick-figure construction or the action line method of creating the foundation of cartoon figures.

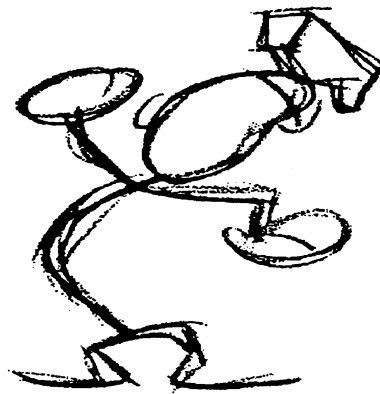

Figure 4-10.—Stick-figure construction or the action line method of creating the foundation of cartoon figures.

Continued on next page

Elemental Construction, Continued

Drawing the cartoon head

The cartoon head is the primary means of relating expression or emotion in the cartoon. Think of the head as a highly flexible balloon, slightly elliptical in shape. Practice drawing ellipses freehand. You do not need to draw perfect ellipses.

Figure 4-11 shows imperfectly shaped freehand ellipses that make perfectly good cartoon heads.

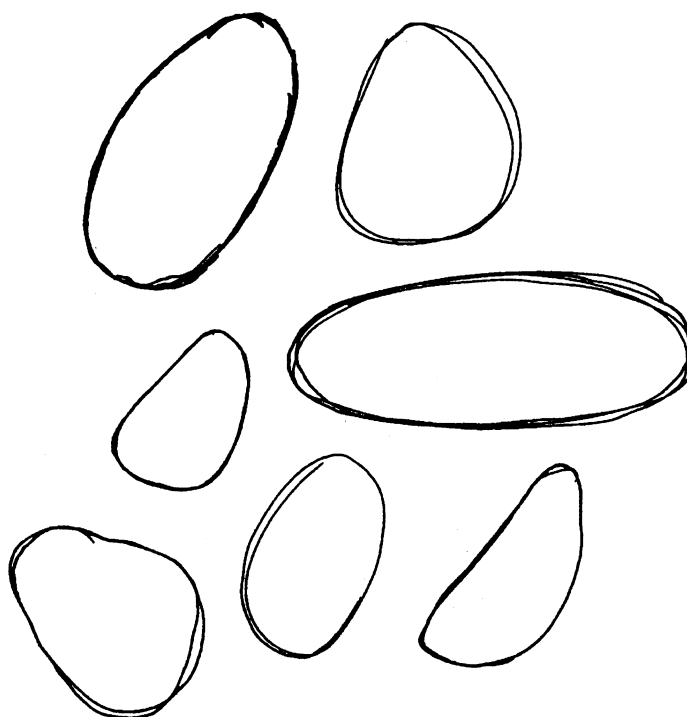

DMV30212

Figure 4-11.—Ellipses form the basis of cartoon heads.

Continued on next page

Elemental Construction, Continued

Drawing the cartoon head (Continued)

The basic head can be squeezed, stretched, flipped, flopped, or inverted at will to create character.

Figure 4-12 illustrates the flexibility of the cartoon head.

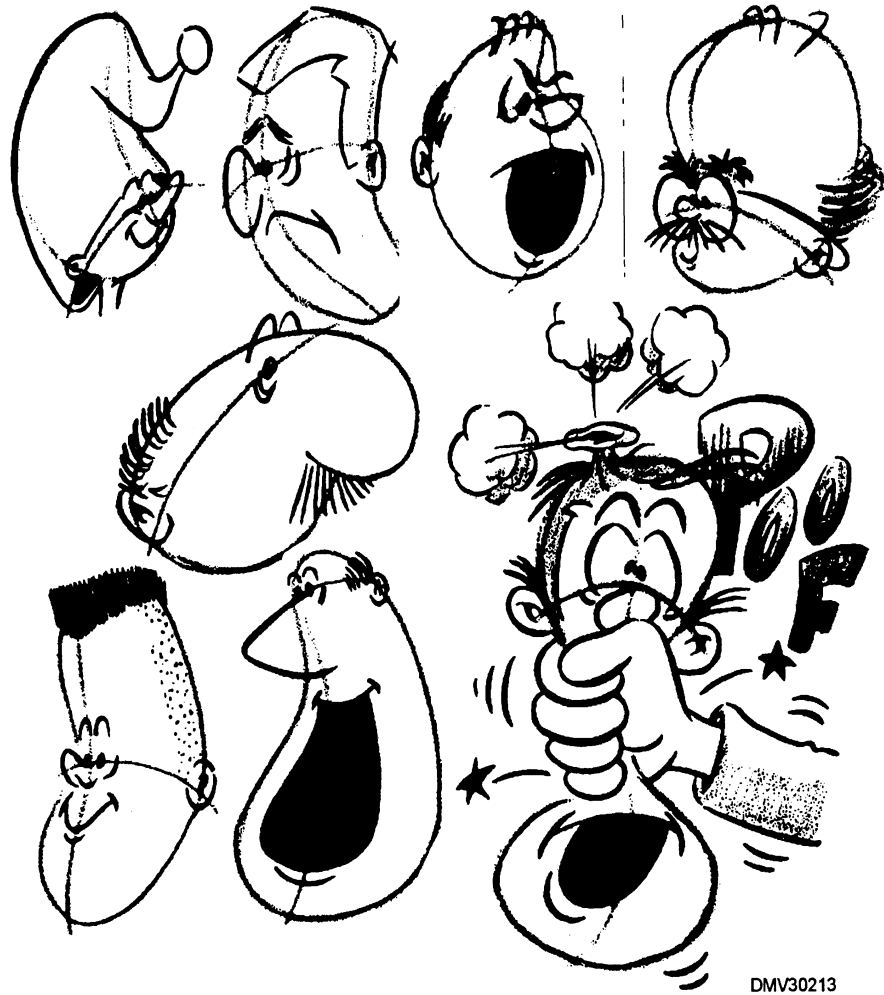

Figure 4-12.—The flexibility of the cartoon head.

Continued on next page

Elemental construction, Continued

Drawing the cartoon head (Continued)

After drawing the balloon, the next step in drawing cartoon heads is adding guidelines to locate the facial features and establish character. Guidelines follow the contour of the basic balloon shape forming other ellipses. Locate the facial features. Ink in details.

Figure 4-13 shows the steps for drawing cartoon heads.

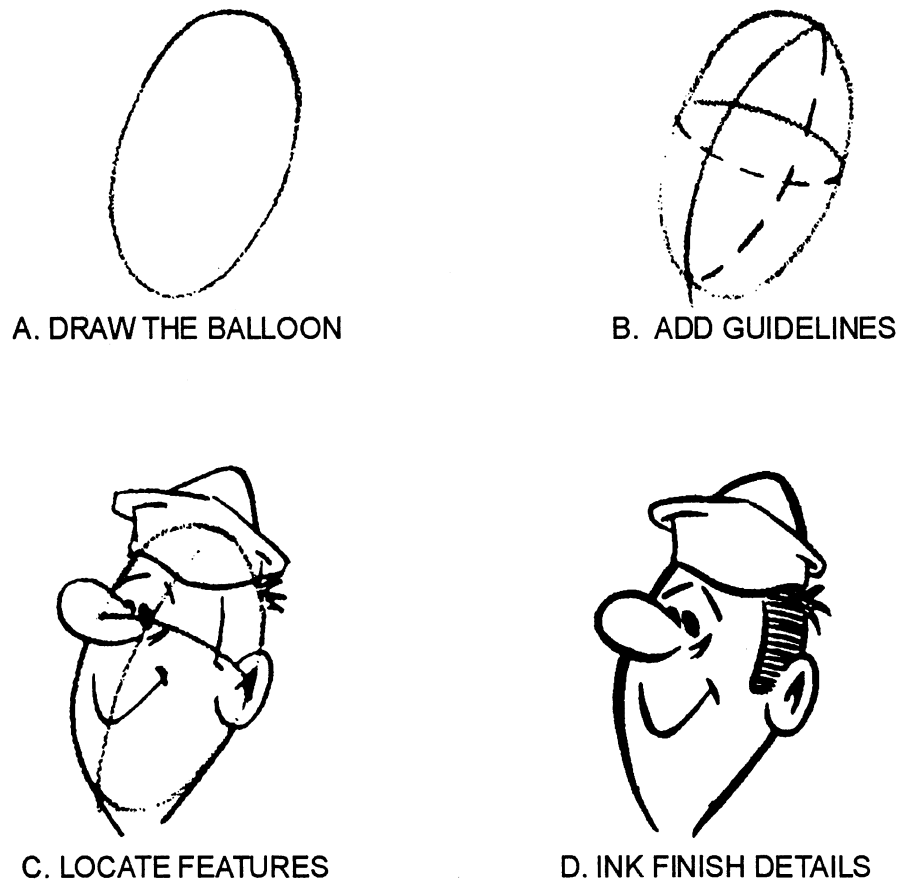

Figure 4-13.—The steps for drawing cartoon heads.

Continued on next page

Elemental Construction, Continued

Positioning cartoon heads

To change position of the head, change the position of the guidelines. Select views of the cartoon head that convey emotion or expression.

Figure 4-14 shows how changing guidelines changes the position of the head.

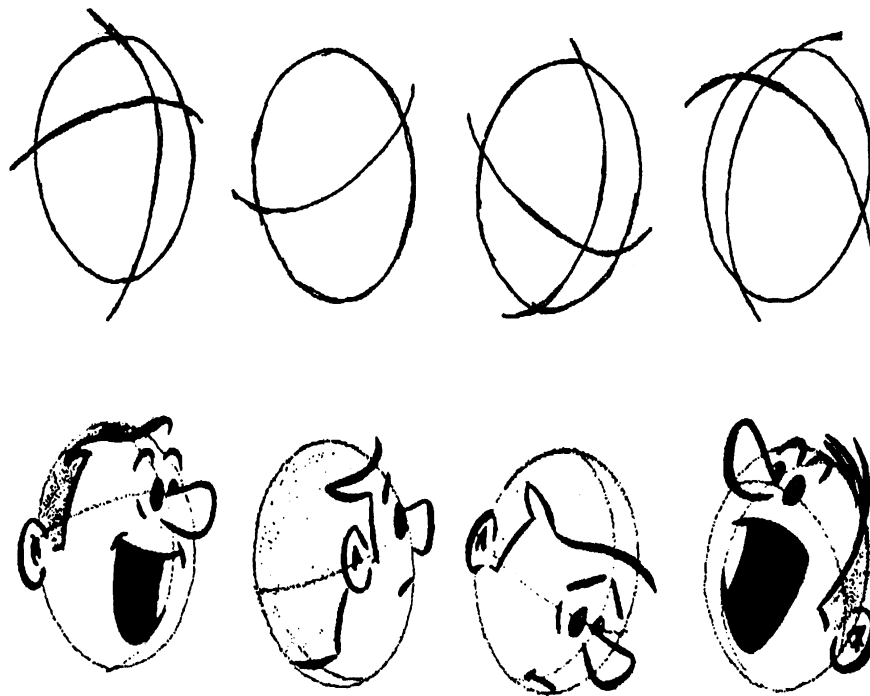

DMV30215

Figure 4-14.—How changing guidelines changes the position of the head.

Continued on next page

Elemental Construction, Continued

Positioning the cartoon head (Continued)

Use the position of cartoon heads to emphasize emotion. Drawing the head with an upward angle suggests hope. A lowered head suggests dejection. Thrusting the position of the head forward, chin first, implies anger or aggression. In surprise, the head leans forward and the neck stretches. Heads thrown backward invoke alarm or laughter. Avoid a flat, lifeless appearance of the head.

Figure 4-15 shows how the position of cartoon heads implies attitudes.

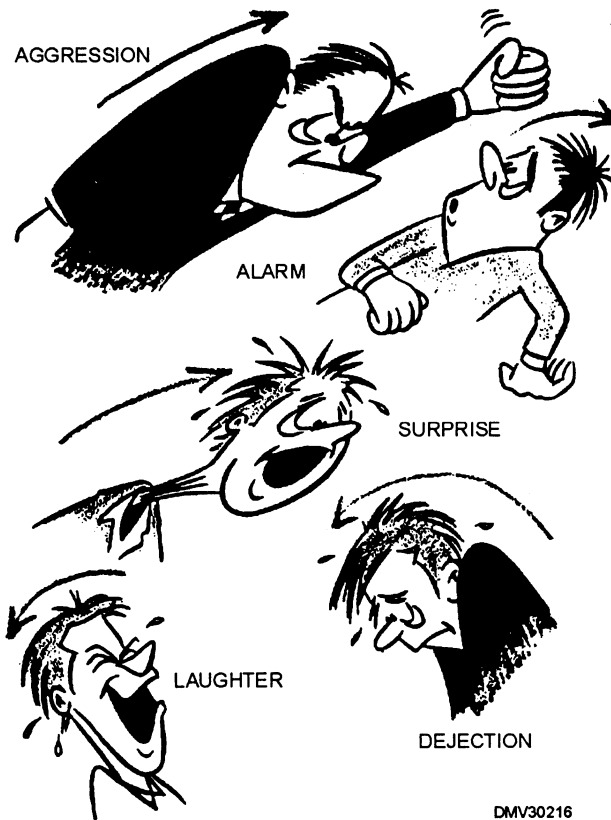

Figure 4-15.—How the position of cartoon heads implies attitudes.

Continued on next page

Elemental Construction, Continued

Positioning cartoon heads (Continued)

In addition to the attitude of the figure, the position of cartoon heads interacts with viewers. The following table lists the views and the effect of each view.

| View | Effect |
|----------------------------|--|
| Three-quarter view | The most common view of the cartoon head, the three-quarter view has depth and character. |
| Left- and right-side views | The left- and right-side views are flat and lifeless. Use the side views only to subordinate a character. |
| Front view | The front view is called a mug shot, or mugging. Mugging develops a direct relationship between the character and the viewer. This technique is useful in animation. |

Figure 4-16 shows the technique of mugging.



Figure 4-16.—The technique of mugging.

Continued on next page

Elemental Construction, Continued

Positioning cartoon heads (Continued)

Figure 4-17 shows a cartoon head as it revolves through various positions.

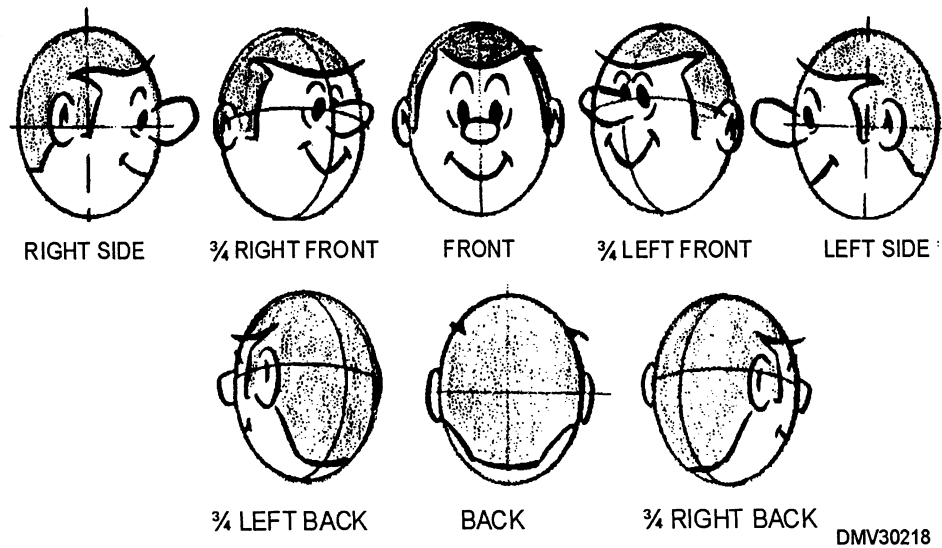

Figure 4-17.—A cartoon head as it revolves through various positions.

Continued on next page

Elemental Construction, Continued

Creating character with cartoon heads

Create character by distorting and combining various features. Everyone has ideas of what some characters look like (called typecasting). Cartooning is the extreme typecasting and exaggeration of prominent features. Make a list of character traits and the physical attributes you believe accurately imply or portray each character. The following table lists common typecast features.

| Character | Features |
|---------------------------------|--|
| Wrestler, numbskull, pugnacious | Bull-necked, heavy-jowled, cauliflower-eared, pug-nosed, heavy-browed, beady-eyed, pin-headed, and with little hair to hide the thickness between their ears |
| Hero, actor, sophisticate | Wavy full-bodied head of hair, clean-shaven, strong-chinned, grecian-nose |
| Loser | Pug-nosed, Jug-eared, weary-eyed, and weak-chinned |

Figure 4-18 shows how facial features create character.



Figure 4-18.—Facial features create character.

Continued on next page

Elemental Construction, Continued

Creating
character with
cartoon heads
(Continued)

Figure 4-19 shows how typecasting features portray characters.



DMV30220

Figure 4-19.—Typecasting.

Continued on next page

Elemental Construction, Continued

Features of cartoon heads

The features of the cartoon head define character, convey emotions, and send messages. The features include the moveable parts of the face like the mouth, eyes, and eyebrows, which carry the most emotive impact; and hair, nose, and ears, which add little to expression but develop character.

HAIR: Draw hair to conform to the shape of the head. An abundance of hair belongs on the heads of moppets, heroes, and playboys. Hair stands on ends when you are scared, becomes tousled when frustrated, and droops with despair. Even the lack of hair is a sign of many characteristics such as old age, worry, and wisdom. Do not draw each individual strand of hair or create masses of highlights. Draw the hair simply, with flowing strokes of the pen or brush.

EYEBROWS: Raised eyebrows indicate surprise or laughter. Lowered eyebrows imply sternness and anger. Bushy eyebrows go to the heavy or tough guys, the boss, and people with lots of hair on their heads. Thin, sparse eyebrows go with pretty women or handsome men.

EYES: Draw eyes as simple dots or circle them to represent eyeballs. When drawing eyes on women and children, keep the eyeline low on the basic balloon shape, a little over halfway down the vertical guideline.

EARS: Most ears are simple, except the outlandish, jug-ears of country bumpkins and cauliflower adornments of the tough guy. You can give women figures additional character by the type of earrings they wear. Flagrantly large, geometrically-shaped forms look better on “showgirl” types, while small, unobtrusive earrings are worn by “ladies.”

NOSE: Noses lend themselves well to exaggeration. Normally, noses are curvilinear forms and you should draw them simply. Some noses, such as the grecian nose, is geometrically angular.

MOUTH: Mouths are one of the most expressive features on the face. For example, you can shape a mouth to appear as though it is speaking particular words.

CHIN: Not often thought of, the chin, or lack of it, is a good indicator of character. Aggressive or belligerent chins thrust forward, while those of cowards tend to recede.

Continued on next page

Elemental Construction, Continued

Features of
cartoon heads
(Continued)

Figure 4-20 shows how basic facial expressions convey emotions.

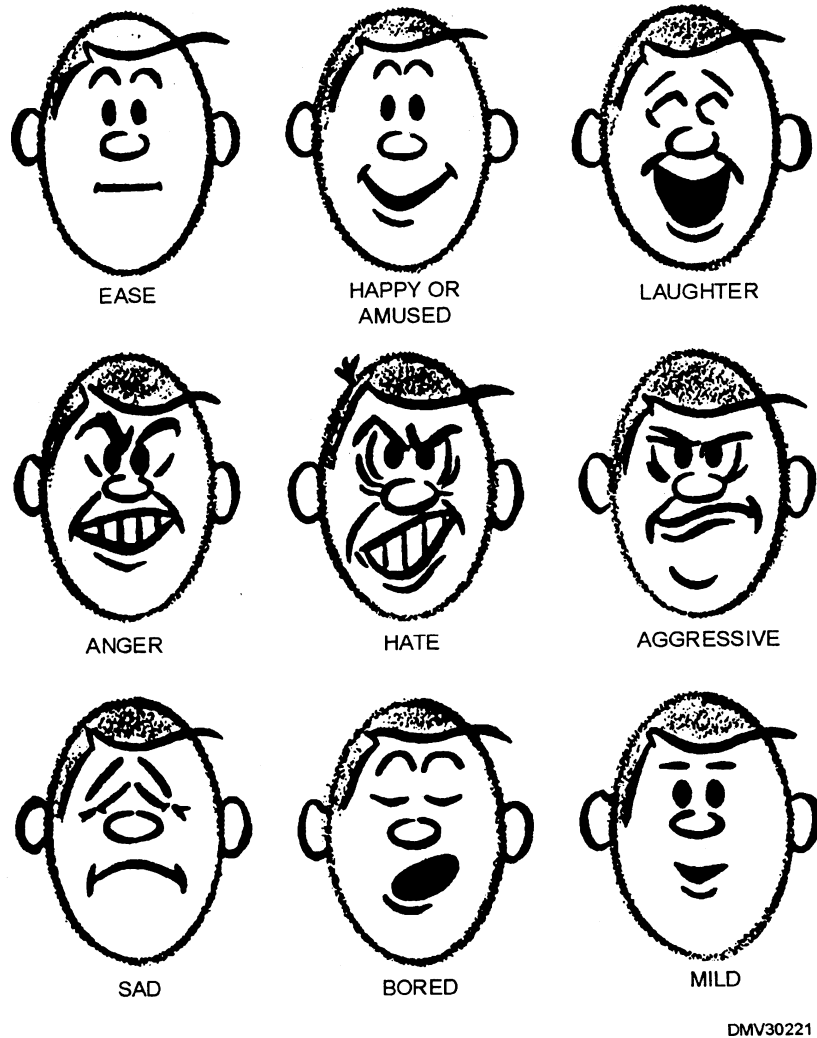

Figure 4-20.—Basic facial expressions.

Continued on next page

Elemental Construction, Continued

Features of the
cartoon head
(Continued)

Figure 4-21 shows more basic facial expressions.



Figure 4-21.—More basic facial expressions.

Continued on next page

Elemental Construction, Continued

Constructing the cartoon figure

You are now ready to begin constructing the cartoon figure. Return to the stick figure foundation drawing. Indicate, more specifically, the action of the arms, legs, hands, feet, and torso using the four basic shapes of the cube, cone, cylinder, and sphere. Although the basic forms can be stretched, condensed, or exaggerated, always begin with the basic forms.

Figure 4-22 shows basic shapes added to the foundation of a cartoon figure.

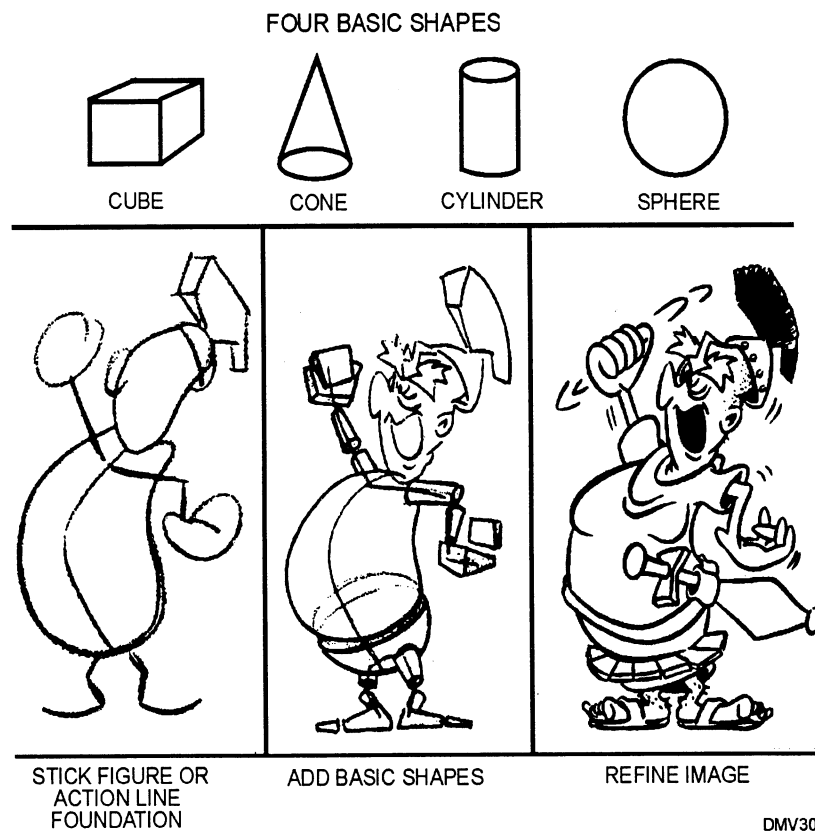

Figure 4-22.—Add basic shapes to the stick-figure foundation of a cartoon figure.

Continued on next page

Elemental Construction, Continued

**Constructing
the cartoon
figure
(Continued)**

Figure 4-23 illustrates how basic shapes are integral to cartoon construction.



DMV30224

Figure 4-23.—Basic forms are integral to cartoon construction.

Continued on next page

Elemental Construction, Continued

Constructing the cartoon figure (Continued)

Except in extreme cases, the upper arm should remain proportional to the lower arm and the upper leg to the lower leg. Rarely exhibit muscles on exaggerated cartoon figures except to suggest violent action (lifting, pulling, etc.), toughness, or masculinity. Regardless of muscularity or lack of it, bend all body parts where they are supposed to bend.

Figure 4-24 shows how even muscularity in cartoon figures is subject to exaggeration.



DMV30225

Figure 4-24.—Exaggerated muscularity.

Continued on next page

Elemental Construction, Continued

Foreshortening Foreshortening is the principle of perspective in which objects that slant toward or away from the viewer seems to diminish in size and change shape as they recede toward the background. Use foreshortening to proportionately alter body parts that go toward or away from the viewer. Foreshortening gives figures a three-dimensional appearance by creating depth and interest.

Figure 4-25 shows the effects of foreshortening.

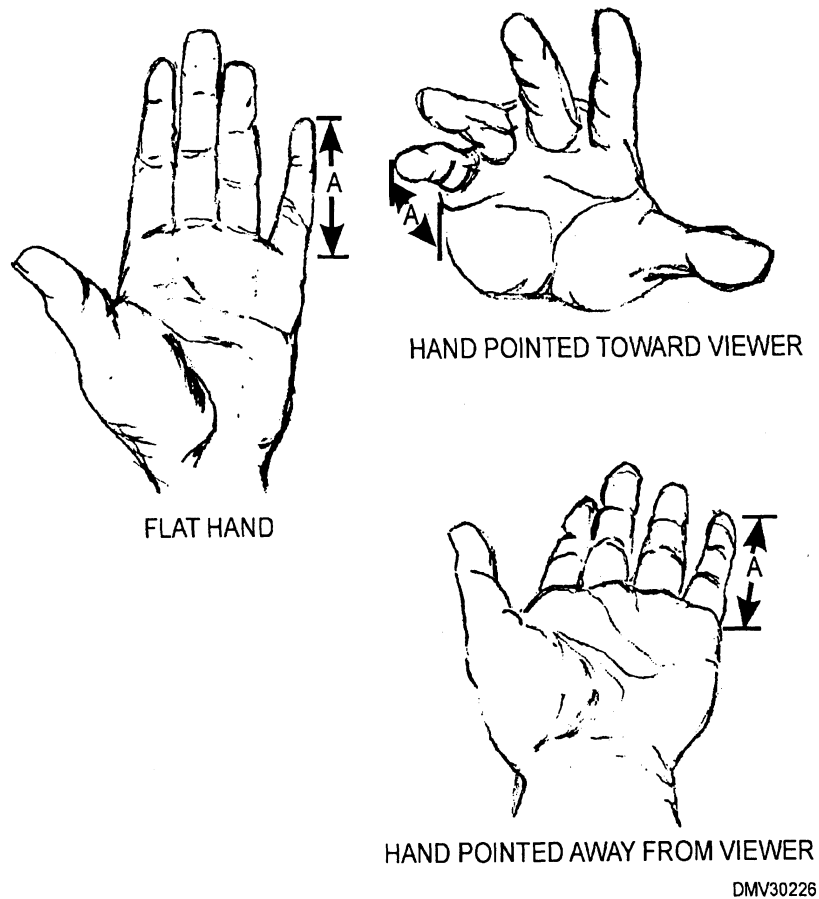

Figure 4-25.—A foreshortened hand.

Continued on next page

Elemental Construction, Continued

Drawing through

Drawing through means to draw shapes as if they are made of glass. This transparency allows you to see where and how to attach arms and legs. To locate the position of arms, legs, and other parts use the drawing through method and also use foreshortening.

Figure 4-26 shows how drawing through basic shapes helps to locate arms and legs.



Figure 4-26.—Drawing through shapes helps to locate arms and legs.

Continued on next page

Elemental construction, Continued

Hands

There is no one way to draw hands on cartoon figures. Notice how many fingers cartoon figures have the next time you read the funny papers. Some characters have three fingers, other characters have as many as ten. The number of fingers is as much an element of drawing style as it is figure action. Hands mirror emotions and punctuate expressions. Hands also reinforce character. For example, aging hands are bony and thin, while baby hands are pudgy. Block in the basic shape of the hand using the four basic shapes. The basic form is a hinged two-piece element with the thumb added as an extension. Exaggerate and detail the hands and fingers after you have them positioned and proportioned correctly.

Figure 4-27 shows fundamental forms detailed into hands.

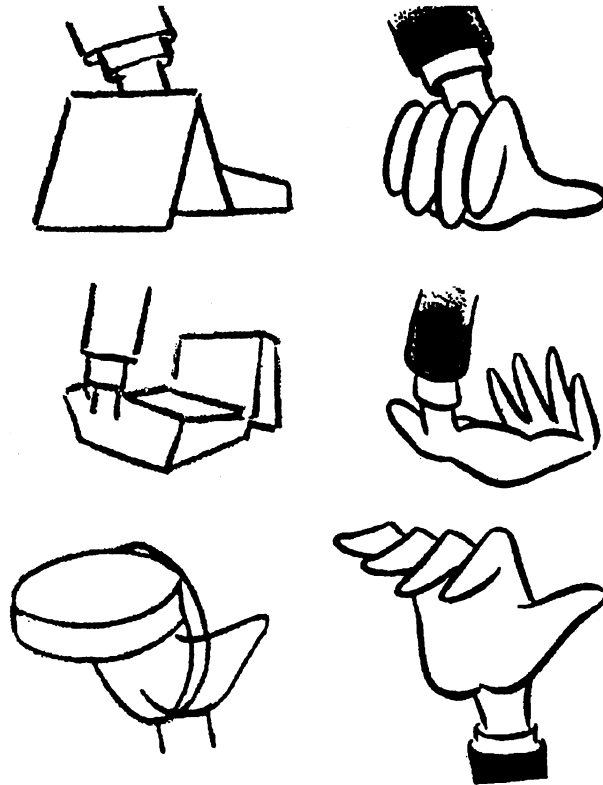

Figure 4-27.—Basic forms detailed into hands.

Continued on next page

Elemental Construction, Continued

Feet

Feet deserve as much attention as hands in drawing to portray character, emotion, or expression. Each foot is basically a wedge hinged to a small block or cylinders (toes). The foot moves easily from side-to-side because of the way the foot hinges to the ankle. Reduce the foot to basic shapes to draw the shape in correct proportion and position. Exaggerate and detail the feet and toes. Outlandish feet can lend a great deal of humor to a cartoon.

Figure 4-28 shows how humorous feet appear.

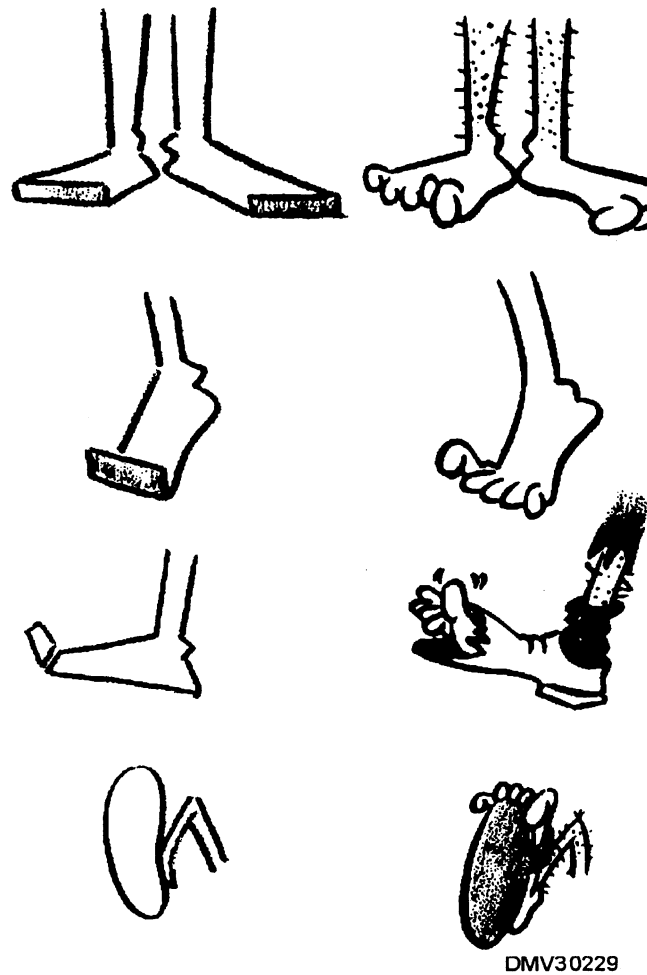

Figure 4-28.—Humorous cartoon feet.

Continued on next page

Elemental Construction, Continued

Animal forms

People attribute human qualities to their pets and other animals. The more human like you draw animals in a cartoon, the more interesting they become and the more people relate to them. You should know animal anatomy to draw animal cartoons. Reduce cartoon animals to basic shapes. Use ellipses (balloons) or combinations of balloons to draw animal bodies. Exaggerate extremities in the animal as you would for cartoon figures. Draw the action lines, head, legs, and torso. Once you have the basic shapes sized and positioned, you are ready to refine your drawing.

Figure 4-29 shows the basic shapes in the drawing of cartoon animal figures.



DMV30230

Figure 4-29.—Basic shapes in animal cartoons.

Continued on next page

Elemental Construction, Continued

Animal forms
(Continued)

Figure 4-30 shows the construction of animal heads using basic forms.

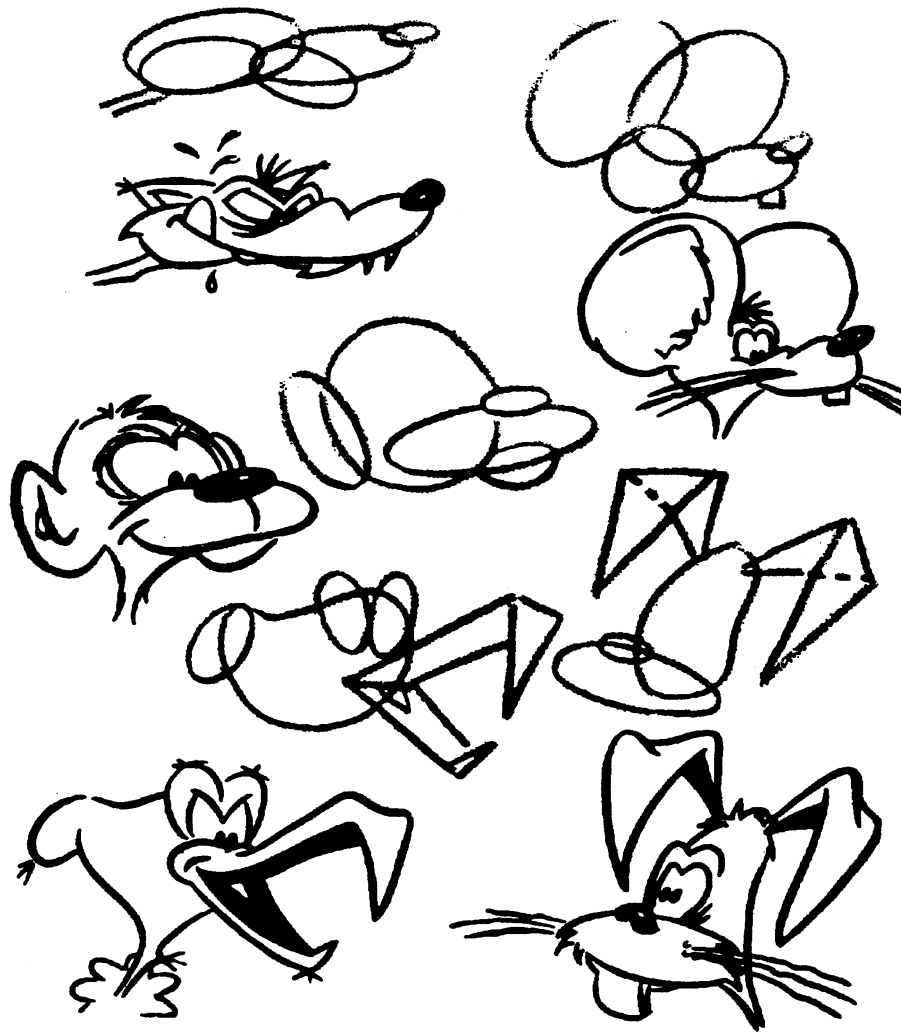

DMV30231

Figure 4-30.—Constructing animal heads using basic forms.

Continued on next page

Elemental Construction, Continued

Animal forms
(Continued)

Figure 4-31 shows an animal figure constructed with ellipses or balloons.



DMV30232

Figure 4-31.—An animal figure constructed with ellipses or balloons.

Continued on next page

Elemental Construction, Continued

Animal forms
(Continued)

Figure 4-32 shows an animal figure and an exaggerated animal figure.

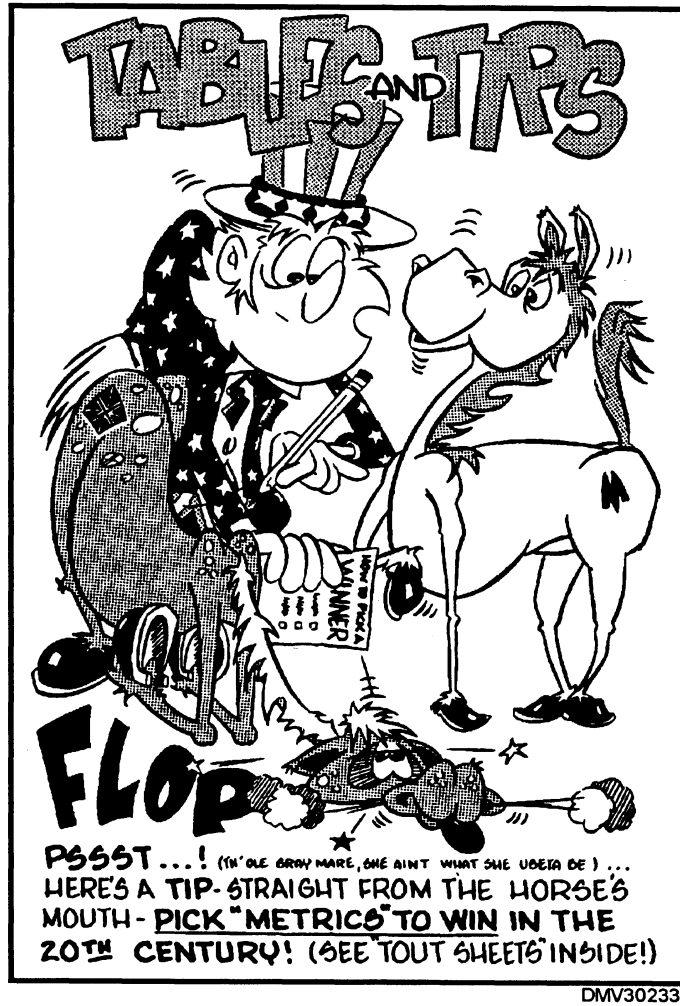

Figure 4-32.—An animal figure and an exaggerated animal figure.

Incidental Construction

Introduction

Incidental construction is the process of drawing of all other elements in a cartoon. Elements like clothing, settings, and props add to the cartoon, but they are subordinate to the figure. Clothing, settings, and props are added to the cartoon after you draw the main figure.

Clothing

Clothing plays an important part in creating character. Match the type of clothing to the character, especially in footwear and hats. Clothing should conform to the contour of the body. When you draw patterned or striped clothing, follow the body lines and draw just enough to recognize the pattern.

Figure 4-33 shows how clothing figures cements the character.



DMV30234

Figure 4-33.—Clothing creates character.

Continued on next page

Incidental Construction, Continued

Settings

Settings locate figures and explain situations. Settings in cartoon construction should be simple and not detract from the main character. Before drawing settings, draw thumbnail sketches to determine the best view of the cartoon. Look at the chosen view and determine the most advantageous use of tonal patterns and black areas. As black and white line art, the cartoon should present a balance of light, grey, and black areas.

Figure 4-34 indicates how carefully placed tonal values and areas of black and white accent images.

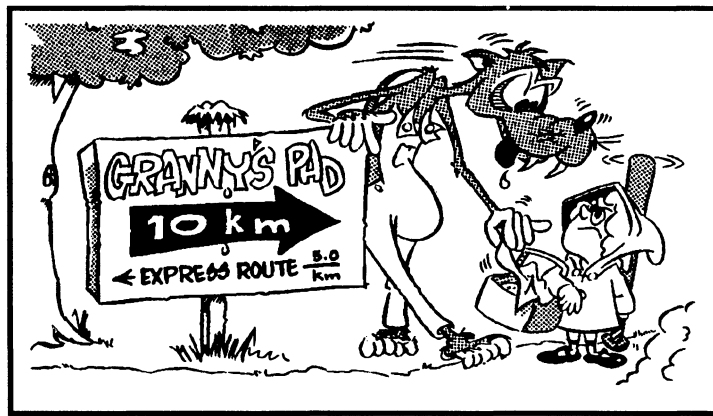

DMV30235

Figure 4-34.—Two examples of planned tonal values and areas of black and white.

Continued on next page

Incidental Construction, Continued

Settings (Continued)

If you are drawing elaborate backgrounds in the setting, reduce everything to basic forms, draw through these forms, and foreshorten perspective.

Figure 4-35 shows basic form as it applies to settings.

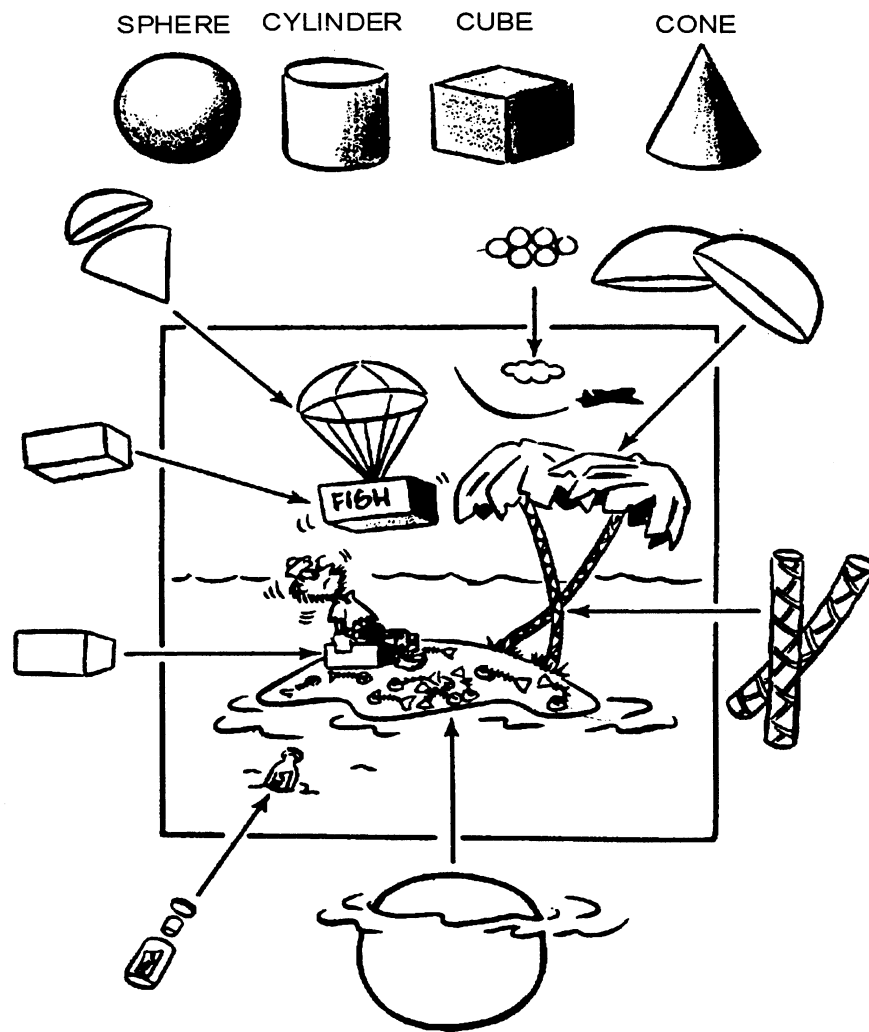

Figure 4-35.—Basic forms in settings.

Continued on next page

Incidental Construction, Continued

Props

Props are any additional item in the cartoon setting (excluding the figures) used to explain the cartoon or character action. Cartoon figures should never serve as props. Keep the props simple. Props help tell a story but, too many props make a cartoon hard to read. Too many props confuse the viewer and subordinate the figure. In rare compositions, elaborate props may be the center of interest.

Figure 4-36 shows how props can confuse communication.



DMV30237

Figure 4-36.—Props can confuse the viewer.

Technique

Introduction

Successful illustrators have developed a unique way of seeing and portraying, life. The humorist, political satirist, cartoonist, animator, illustrator each have fundamentally similar training and knowledge of tools in the trade. It is how they convert what they see in their mind's eye onto paper that sets them apart.

Technique

Technique is personal style developed through practicing the craft of illustration and cartooning. Personal style continually evolves through practice to redefine and refine technique. Only through constant practice can you develop an eye for what is visually correct and personally expressive.

Practice

It doesn't require a lot of equipment to practice cartooning and caricature. Keep a pad of drawing paper in the car for those extended waits on the road. Keep a small notebook in your pocket for the next time you have to hurry up and wait. Look for opportunities to practice drawing and look at the abundance of people around to draw.

Summary

Review

This chapter defines cartooning, caricature, and animation. Elemental construction of basic cartooning involving the action lines, head, hands, feet, and upper and lower torso in basic forms provide a foundation for the development of cartoons. Incidental construction of clothing, settings, and props explains the importance of setting the stage of cartoons. Technique emphasizes practice in the development of personal style.

Comments

Attributing art to an individual without first seeing a signature is a form of recognition. This recognition or personal style is something all DMs strive to attain, some with more success than others. We have all transferred to duty stations where we see work left by previous DMs. After we transfer, incoming, up-and-coming DMs will look at our work. Make sure the work you leave behind is your best. Practice to be the best.

Caricature drawing is one of the most sought after skills a DM offers. Once a DM's ability to draw caricatures becomes known, that individual will be repeatedly asked for art. Use your natural sense of humor in observing those around you. Cartooning and caricature drawing go a long way toward cementing your reputation as a talented and versatile Illustrator Draftsman.

CHAPTER 5

LETTERING

Overview

Introduction As an Illustrator Draftsman, you letter official publications, posters, lecture pads, and displays. You must know what makes one alphabet easier to read than another and what gives one alphabet more beauty and character than another. Lettering has often been called an art form in itself. This chapter will examine the geometry and presentation of lettering and calligraphy.

Objectives The material in this chapter enables you to do the following:

- Differentiate between lettering, typography, and calligraphy.
- Define typefaces.
- Distinguish between typefaces and type fonts.
- Duplicate the six basic strokes of freehand and calligraphic lettering.
- Distinguish between lettering used for text and lettering used for headlines.
- Recognize the importance of thumbnail sketches, roughs, and comprehensives in layouts with extensive lettering.
- Identify the uses of different type sizes.
- Evaluate the use of dry transfer lettering.

Continued on next page

Overview, Continued

Acronyms

The following table contains a list of acronyms you must know to understand the material in this chapter:

| Acronym | Meaning |
|---------|--------------------|
| CAPS | Capital Letters |
| CL | Center Line |
| LC | Lower Case Letters |
| Pixel | Picture Element |
| UC | Upper Case Letters |

In this chapter

This chapter covers the following topics:

| Topic | See Page |
|------------------------|----------|
| Lettering | 5-3 |
| Letter Nomenclature | 5-6 |
| Letter Geometry | 5-13 |
| Letter Classifications | 5-18 |
| Letter Strokes | 5-27 |
| Letter Compositions | 5-32 |
| Lettering Mediums | 5-43 |
| Lettering Aids | 5-50 |
| Calligraphy | 5-54 |

Lettering

Introduction

Alphabets derived from the hieroglyphics of ancient Egypt. Through the ages, letterers or scribes modified and decorated letters and their designs according to the preferences and fashions of the day. As printing replaced lettering, people lost the knowledge and understanding needed to make good letter forms.

Lettering versus printing

Lettering, not printing, is the correct term for making letters by hand. Lettering may be drawn freehand or by mechanical methods. Printing means the production of printed material on a printing press. Printed matter done with type is known as typography. Typography also involves the style, the arrangement, and the appearance of typeset material.

Lettering

Lettering is any letter created for display, headlines, flyers, name tags, banners, and signage, executed by hand or with lettering aids. Lettering may be plain or ornate. When selecting lettering, consider the image you want the job to convey and select a letter style consistent with the attitude of the material. Legibility should also be a primary concern.

Figure 5-1 shows legible and illegible letter selections.

LEGIBLE

United States Navy

United States Navy

United States Navy

United States Navy

ILLEGIBLE

UNITED STATES NAVY

UNITED STATES NAVY

UNITED STATES NAVY

DMV30238

Figure 5-1.—Legible and illegible letter selections.

Continued on next page

Lettering, Continued

Lettering on technical drawings

Lettering on technical drawings is a simple form of hand lettering that does not contain flourishes. Generally, the letter style on technical drawings is single-stroke gothic executed by hand with conically sharpened pencils. Sharpen pencils regularly to maintain an even width in the pencil stroke. The single-stroke gothic letter style is plain and geometrically unremarkable. You may use lettering aids to letter on technical drawings; however, lettering aids are cumbersome when speed is required.

Figure 5-2 is an example of single-stroke lettering.

SINGLE-STROKE GOTHIC

AaBbCcDdEeFfGgHhIiJjKkLlMmNnOoPpQqRrSsTtUuVvWwXxYyZz
0123456789 !@#\$%^&*()_+={}|~";?/><.,

DMV30239

Figure 5-2.—Single-stroke gothic letters used on technical drawings.

Continued on next page

Lettering, Continued

Calligraphy

Calligraphy is hand lettering in its most sophisticated form. The principles of geometric proportion, nomenclature, composition, and visual impact apply to calligraphy as they do to lettering. Calligraphy, however, allows more freedom and creativity than established, uniform typefaces. A portion later in this chapter covers calligraphy specifically and in more detail.

Figure 5-3 is an example of calligraphic letters.



DMV30240

Figure 5-3.—Calligraphic lettering.

Letter Nomenclature

Introduction

Knowledge of the nomenclature or terminology associated with lettering and typography is important. Understanding industry standard terms greatly increases your ability to effectively communicate lettering requirements to subordinates and any commercial shops.

Typefaces or type styles

Typeface or type style refers to the design of letters. Decorative and plain letters are named for their appearance or for the designer who created them.

Figure 5-4 shows two typefaces, one named for appearance and one named for the designer.

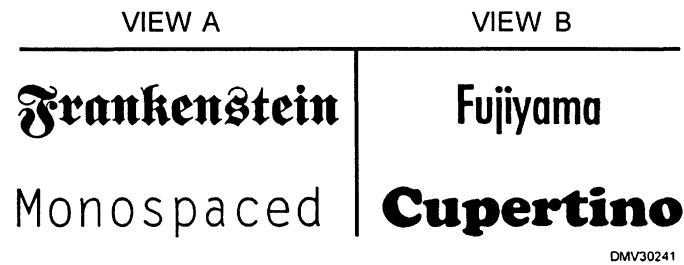
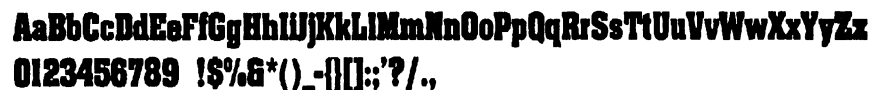

Figure 5-4.—Typefaces; A. Named for appearance, B. Named after the designer.

Type fonts

Type fonts are the collected alphabet, numbers 0 through 9, and selected punctuation marks in a particular typeface. Fonts are complete sets of characters in the same typeface and size.

Figure 5-5 shows that all the characters in a particular typeface are called a font.



DMV30242

Figure 5-5.—A font or collection of the complete alphabet, numerals, and punctuation for a typeface.

Continued on next page

Letter Nomenclature, Continued

Type series Type series are different sizes of the same typeface.

Figure 5-6 is an example of a type series.

Casablanca
Casablanca
Casablanca
Casablanca
Casablanca
Casablanca
Casablanca
Casablanca
Casablanca
Casablanca
Casablanca
Casablanca
DMV30243

Figure 5-6.—A type series.

Type families Type families are typefaces that share similar features and appear visually related. Differences in size are immaterial. Only similar features identify typefaces to a family.

Figure 5-7 shows that visually related typefaces create families.

BINNEY Old Style
BODONI Bold
BODONI Book
BODONI Bodoni
CASLON, True-Cut
CASLON Old Style
CASLON Bold
CASLON Old Style
CASLON No. 113, Condensed
CASLON Bold Condensed
CASLON Caslon
CENTURY Expanded
CENTURY Expanded Bold
CENTURY Schoolbook
CENTURY Schoolbook
CHELTENHAM Cheltenham
CHELTENHAM Bold Extra Condensed
CHELTENHAM Bold
CHELTENHAM Old Style
CHELTENHAM Wide
CLOISTER Bold Condensed
CLOISTER Oldstyle
CLOISTER Bold
DMV30244

Figure 5-7.—A family of visually related typefaces.

Continued on next page

Letter Nomenclature, Continued

Type size - height

In type size, height is expressed in points. A point is a unit of measurement that approximates one seventy-second of an inch (1/72). There are approximately 72 points to an inch. Typeface size is measured by its height from capline to baseline.

Figure 5-8 shows how point size affects letter height.

POINT SIZE

8 **A a B b C c D d E e F f**

12 **A a B b C c D d E e F f**

16 **A a B b C c D d E e F f**

18 **A a B b C c D d E e F f**

24 **A a B b C c D d E e F f**

DMV30245

Figure 5-8.—Point size is letter height.

Type size (height) on electronic or mechanical devices

In electronic or mechanical lettering devices, the type size of typeface fonts may be fixed or scalable. Fixed fonts are one size and cannot change. Scalable fonts allow you to electronically or mechanically alter the size of a font. These fonts may appear in points that equate to the printing industry standard of approximately 1/72 of an inch, pixels that represent one picture element on a computer monitor, or points on a computer monitor that closely resemble pixels in size. The choice of points or pixels is part of the software package installed in the computer. Be aware of the differences in electronic and mechanical lettering devices. Know the point size (industry standard of 1/72") equivalent in your software program.

Continued on next page

Letter Nomenclature, Continued

Typeface x-rating

A typeface x-rating refers to the height of the typeface as measured by the vertical space occupied by the lowercase letter x. This proportion varies for each typeface making some typefaces easier to read than others in the same point size.

Figure 5-9 shows how greater x-ratings in the same point size and same typeface may increase legibility.

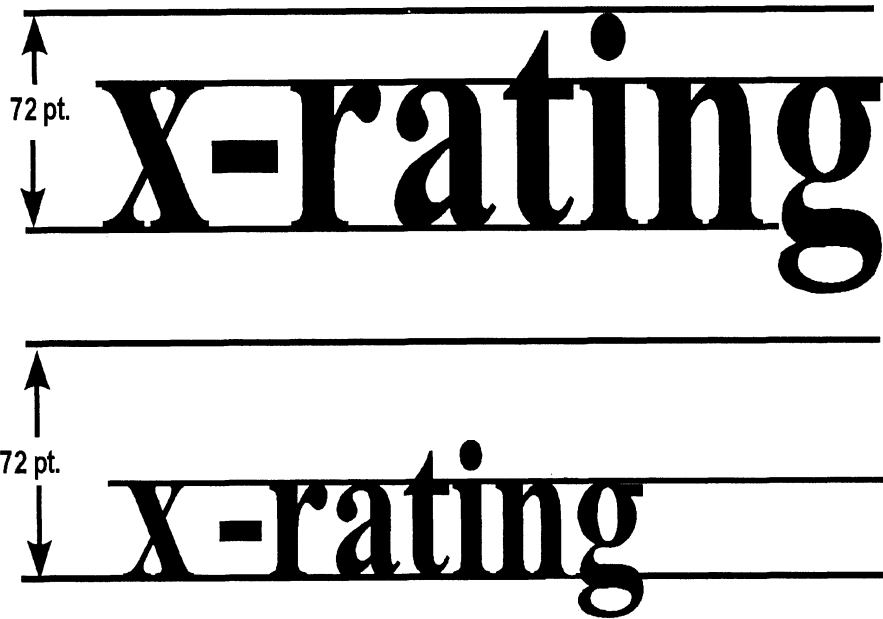

DMV30246

Figure 5-9.—How greater x-ratings result in increased legibility without changing point size.

Continued on next page

Letter Nomenclature, Continued

Font metrics

Font metrics refer to the placement of characters on a line to eliminate unwanted white space between the letters by increasing (letterspacing) or decreasing (kerning) the space between letters to visually improve legibility. Most letters are surrounded by some amount of space. The standard unit of measure for space around letters is the em-square, the space occupied by the uppercase M. Most letters are surrounded by space equal to one em-square. Some letters require less space. Other letters, when placed side-by-side, require more space.

Figure 5-10 shows combinations of letters that may require space alterations.

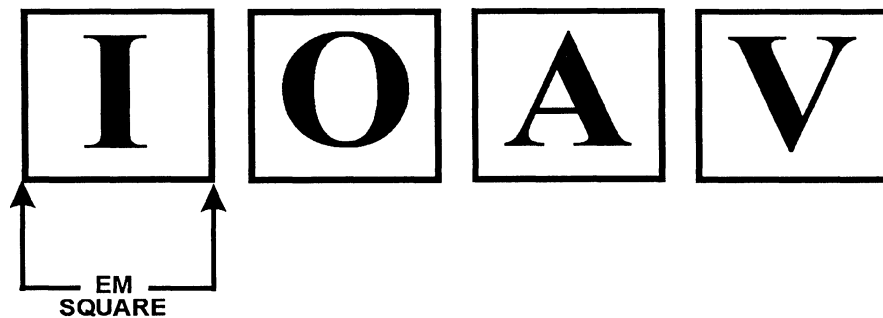

I O A V

DMV30247

Figure 5-10.—Combinations of letters that may require space alterations.

Continued on next page

Letter Nomenclature, Continued

Component parts

Each component part of typefaces or letters has a name. The combination of component parts determine letter characteristics and decoration.

| Part | Description |
|--------------|---|
| Arm | A horizontal stroke extending from the stem |
| Ascender | The stem of a lower case letter that extends above the waistline |
| Bowl or Loop | An enclosed round or oval stroke |
| Counter | Fully or partially enclosed white (negative) space |
| Crossbar | A horizontal stroke connecting two stems |
| Descender | The stem of a lower case letter that drops below the baseline |
| Kern | A cursive connecting stroke |
| Ear | Small strokes attached to the counter of a lowercase letter or stem |
| Serif | An ornamental stroke terminating letter forms |
| Stem | The main vertical stroke |
| Tail | A cross stroke |

Continued on next page

Letter Nomenclature, Continued

Component
parts
(Continued)

Figure 5-11 locates component parts and features of letters.



DMV30248

Figure 5-11.—Letter component parts.

Letter Geometry

Introduction

The appearance of letters depends upon geometry. Altering the ratio of one dimension to another of any component part of a letter will change style, attitude, and legibility. Understanding the effects of the changes you make is the foundation to creative and distinctive lettering.

Guidelines

There are six basic guidelines to layout before lettering. Draw guidelines lightly in pencil for easy erasure later. Before any lettering begins, set the guidelines that define the parameters of the letter.

BASELINE: The baseline is a guideline that aligns the bottom of each letter. With the exception of rounded letters (C, G, O, S, and Q), each letter terminates on the baseline. Rounded letters appear smaller than letters with linear dimensions therefore, extend them slightly below the baseline.

CAPLINE: The upper limit of capital letters (CL) is set by a capline. With the exception of rounded letters, each capital letter terminates at the capline. Extend rounded letters slightly above the capline to give them the appearance of being equal in size to other letters. The distance between the baseline and the capline is the point size of the letter.

WAISTLINE: A guideline called a waistline sets the upper limit of lower case (LC) letters. The waistline is also known as an x-rating. Place the waistline between the capline and baseline. Normally, the waistline is drawn two thirds the height between the capline and the baseline. In decorative letters, altering the waistline or x-rating of letters, increases or decreases legibility without changing the overall point size of the letter.

Figure 5-12 shows the placement of the baseline, capline, and waistline.

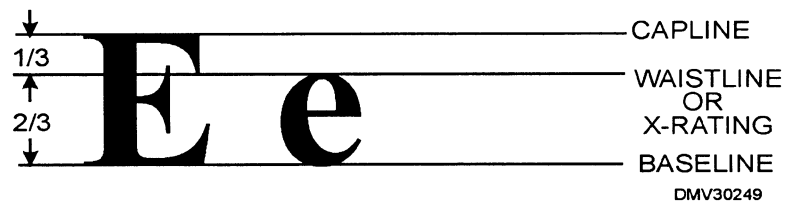

Figure 5-12.—Positioning the capline, waistline, and baseline.

Continued on next page

Letter Geometry, Continued

Guidelines (Continued)

LINE OF ASCENT: The line of ascent is drawn above the capline to set the height of lower case letters whose stems extend above the waistline such as letters like d, f, h, k, l, and b. The letter t often falls short of both the capline and the line of ascent. The line of ascent is drawn above or on the capline and equals approximately one third the distance between the capline and baseline. In some cases, the capline and the line of ascent are the same line. Ascender is the name given to the tall stems of lower case letters.

LINE OF DESCENT or DROP LINE: The line of descent or drop line is the line that terminates stems of letters that drop below the baseline such as q, y, p, g, and j. Draw the line of descent below the baseline at a position equal to one third the distance from capline to baseline. The portion of the stem that falls below the baseline is called the descender.

Figure 5-13 shows the placement of the lines of ascent and descent.

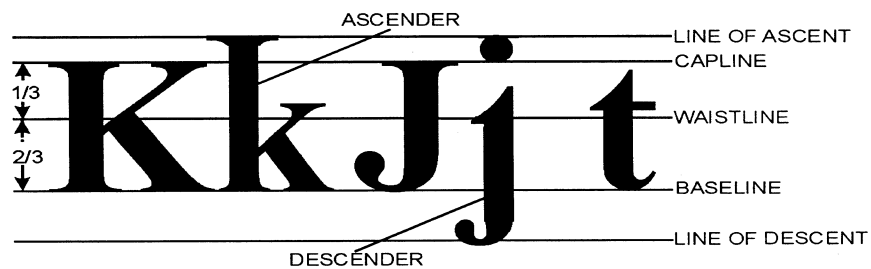

Figure 5-13.—Lines of ascent and descent.

Continued on next page

Letter Geometry, Continued

Guidelines (Continued)

DIRECTION LINES: Direction lines are randomly spaced vertically drawn guidelines or guidelines drawn at an incline that help maintain uniformity. Straight vertical lines assist even spacing and in keeping the strokes of the letters parallel. Inclined lines assist in spacing and in maintaining uniformity in the slant of the letter. Inclined lines may be drawn at any angle but normally do not exceed a maximum angle of 68 degrees. Letters drawn excessively inclined appear to be falling over and disorient viewers.

Figure 5-14 shows how vertical and inclined directional lines assist in maintaining uniformity.

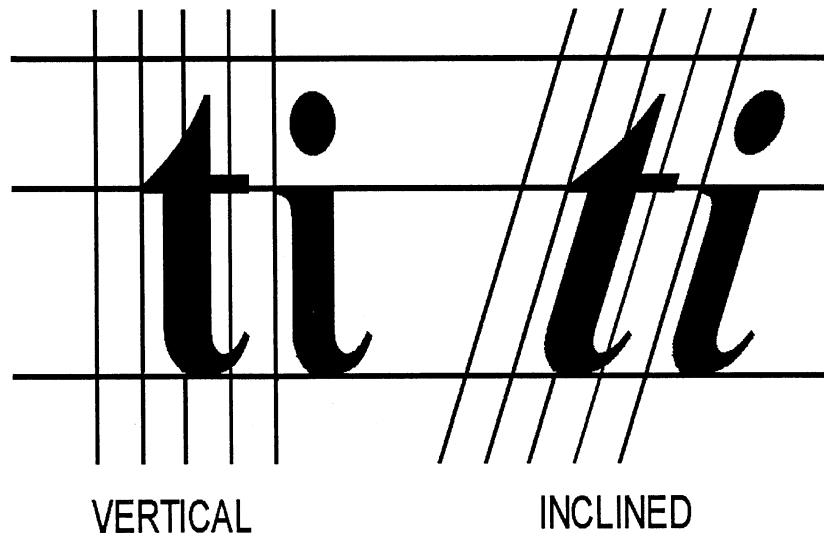

DMV30251

Figure 5-14.—Vertical and inclined lines assist in maintaining uniformity.

Continued on next page

Letter Geometry, Continued

Letter weight

The weight of letters directly influences legibility and appearance. The weight of letters may be lightface, open-face, regular weight, or boldface. Additionally, letter dimensions may be condensed, expanded, geometrically symmetric, or italicized.

LIGHTFACE: Thin, hairline strokes that give a light, airy illusion to the letter style are characteristic of lightface letters.

OPEN-FACE: Open-faced letters appear as outlines of letters with center portions left open. Open-faced letters, when left open, appear lighter in weight than letters filled in. You may fill in an open-faced letter with a contrasting color or colors for creative effect.

REGULAR WEIGHT: Neither too thick or too thin, regular weight letters reproduce with optimum legibility.

BOLDFACE: Boldface letters appear heavy and dense. They add emphasis and seem to jump at the viewer.

Figure 5-15 shows letter weight.

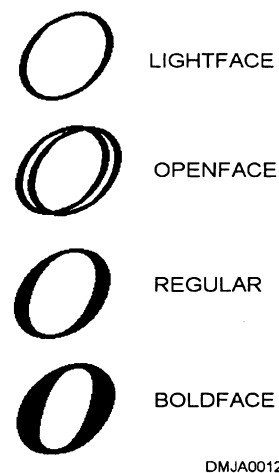

Figure 5-15.—Using the letter “O” to demonstrate letter weight.

Continued on next page

Letter Geometry, Continued

Letter weight (Continued)

CONDENSED: Letters that appear vertically squeezed or pinched are called condensed. Condensed letters give the appearance of being heavier than they really are.

EXPANDED: Horizontally stretched or flattened letters are called expanded. They appear lighter in weight than they really are.

GEOMETRICALLY SYMMETRIC: Geometrically symmetric letters have geometrically or mathematically correct dimensions and proportions. To determine if letters are geometrically proportioned, look at the letter “O” for perfect roundness and evaluate any distortions.

ITALICIZED: Italicized letters slant to the left or right of center. Before negatively affecting legibility, letters may lean a maximum of 68 degrees from center. Italicized letters add emphasis.

Figure 5-16 shows the letter “O” in various letter weights.

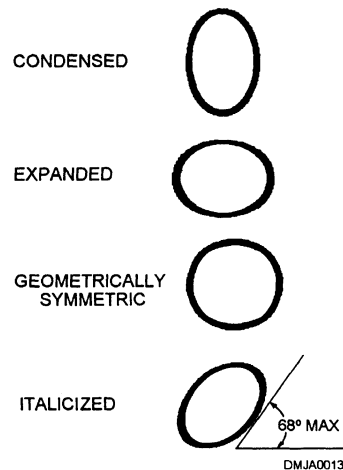

Figure 5-16.—Using the letter “O” to demonstrate geometric proportions of various typefaces.

Letter Classifications

Introduction

Alphabet styles reflect certain characteristics such as refinement, dignity, boldness, and strength. Properly used, letter styles convey the feeling or mode of messages. You should be able to recognize the different styles and know something of their general usage.

Capital letters

The first distinction between letters is between capital letters and lower case letters. Capital letters are referred to as caps or upper case (UC). Upper case letters fill the distance between the capline and baseline. Occasionally, letters between the waistline and baseline may appear as capital letters. Caps that extend only from the baseline to waistline are called small caps.

Figure 5-17 illustrates the differences in caps and small caps.



Figure 5-17.—Caps and small caps.

Letter Classifications

Lower case letters

Lower case letters (LC) are letters that appear as small letters whose main body lies between the baseline and waistline. The form of lower case letters is often altered from that of the cap. LC letters may extend from the line of ascent to the line of descent as in letters like i, j, k, l, and etc.

Figure 5-18 shows how lower case letters may reach the line of ascent or the line of descent.

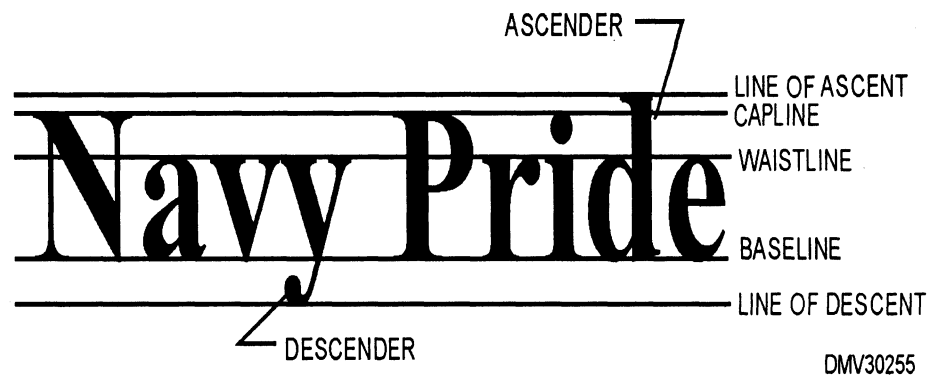

Figure 5-18.—Lower case letters reaching the lines of ascent and descent.

Continued on next page

Letter Classification, Continued

Major groupings

Most letter styles fall into one of six major groupings. Each grouping further subdivides into series, families, sizes, and weights. The six major groupings of letter styles are roman, gothic, script, text, italic, and contemporary.

Figure 5-19 shows the six major groupings of letters.

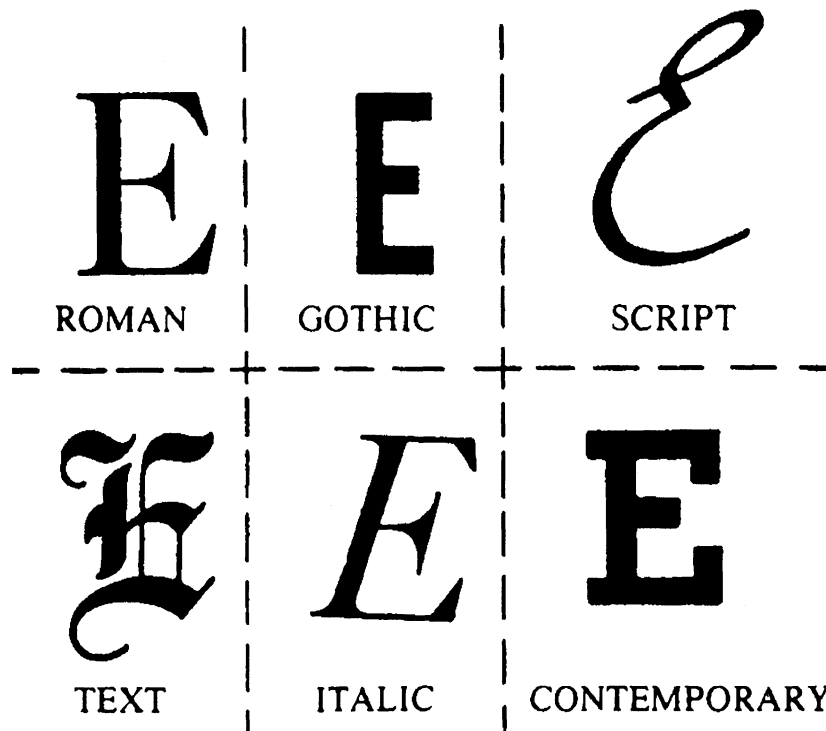

DMV30256

Figure 5-19.—Major letter groups.

Continued on next page

Letter Classification, Continued

Roman letter group

Roman letters are composed of thick and thin lines terminated with small crosstrokes called serifs. The serifs lend unity to letters and blend the letters into easily read words. Roman typefaces are divided into two styles: old style and modern. The chief difference between old style and modern roman letters is the serifs. Old style roman letters have soft-rounded serifs, while the serifs on modern roman letters are heavier with clean-cut hairlines. Roman typefaces are used in the text of magazines, newspapers, and books. Roman letters suggest dignity, refinement, or stateliness.

Figure 5-20 is an example of letters in the roman style.



Figure 5-20.—The roman letter group.

Continued on next page

Letter Classifications, Continued

Gothic letter group

The gothic letter, sometimes called block letters, are constructed of strokes relatively even in weight. Slightly thinner strokes join main stems and curves to avoid giving the letter a dense look. There are no serifs on gothic letters. A letter without serifs is referred to as sans serif. Sans serif letters of even weight also belong to the contemporary letter grouping. Gothic style letters are used for letterheads, envelopes, cards, announcements, and many kinds of office forms.

Figure 5-21 is an example of the gothic letter grouping.

CONDENSED TITLE GOTHIC NO. 11
BANK GOTHIC CONDENSED BOLD
FRANKLIN Gothic Extra Condensed
POSTER GOTHIC
FRANKLIN Gothic Condensed
RAILROAD GOTHIC
BANK GOTHIC CONDENSED MEDIUM
NEWS Gothic
GOTHIC NO. 520 TO 526
LINING Gothic No. 545
ALTERNATE Gothic No. 1
ALTERNATE Gothic No. 2
ALTERNATE Gothic No. 3
NEWS Gothic Extra Condensed
SANS Serif Bold
COPPERPLATE GOTHIC BOLD NO. 132
GOTHIC No. 544
NEWS Gothic Condensed
GOTHIC No. 3 Gothic No. 3
COPPERPLATE GOTHIC NO. 342, HEAVY
LINING PLATE GOTHIC, HEAVY

DMV30258

Figure 5-21.—The gothic letter group.

Continued on next page

Letter Classifications, Continued

Script letter group

The script letter group includes script letters, cursive letters, and swash letters. Each letter style has its foundation in handwriting. Letters in the script letter grouping should not be used as all caps. Straight cap letters in this group are illegible.

SCRIPT LETTERS: Script letters, composed of thick and thin strokes, have hairlines connecting one letter to another. These hairlines are called kerns. Kerns connect letters allowing the letters to flow into words. Script letters may be basic or formal. Basic script retains the curvilinear letter form without thick and thin variations of stroke. The strokes of formal script letters have thick main stems and thin connectors. Script letters give the impression of elegance, dignity, and refinement suitable for announcements or invitations.

Figure 5-22 is an example of basic and formal script.

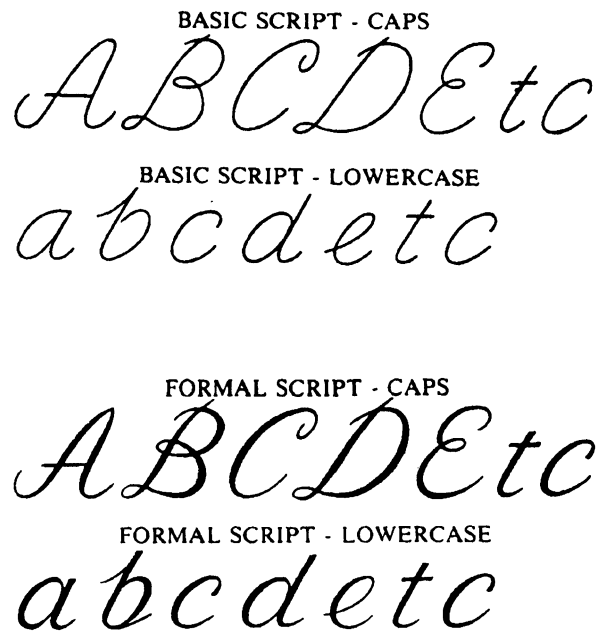

DMV30259

Figure 5-22.—Basic and formal script.

Continued on next page

Letter Classifications, Continued

**Script letter
group
(Continued)**

CURSIVES: Cursive letters are similar to script letters except that cursive letters do not have kerns. Cursive letters add elegance and charm to advertisements, and showcard lettering.

Figure 5-23 is an example of cursive lettering.

The image shows the words "Lydian Cursive" written in a highly decorative, flowing cursive script. The letters are interconnected with elegant loops and flourishes, characteristic of a cursive typeface.

DMV30260

Figure 5-23.—Cursive letters.

SWASH: Swash letters are script and cursive letters with additional flourishes or embellishments. Swash letters have vitality and boldness. Use swash letters with italics to dress up layouts that otherwise might be bare or unattractive.

Figure 5-24 is an example of swash lettering.

The image shows the words "Type No. 16" written in a bold, swashy script. The letters are thick and feature prominent, decorative flourishes, particularly in the 'T' and 'N', giving it a vintage, hand-drawn appearance.

DMV30261

Figure 5-24.—Swash lettering.

Continued on next page

Letter Classifications, Continued

Text letter group

Text style letters are synonymous with Old English letters. Text lettering is one of the oldest letters styles in use. Text letters consist of solid main stems with solid block serifs. Text letters have strong vertical lines. Do not use text letters in all caps or words will be illegible. Limit the use of text letters to layouts that require religious or formal presentations. Use text lettering for prayer books, programs, and invitations.

Figure 5-25 shows examples of the text letter group.

Engravers Old English Bold

Engravers Old English Open

Engravers Old English

Engravers Text

Wedding Text Shaded

Wedding Text

Inland Copperplate

Tudor Black No. 2

Typo Text

Cloister Black

Modern Text

Shaw Text

American Text

WEDDING TEXT *

* WORDS SET IN TEXT CAPS ARE ILLEGIBLE.

DMV30262

Figure 5-25.—The text letter group.

Continued on next page

Letter Classifications, Continued

Italic letter group

Letters in the italic letter group represent letters that incline left or right of center. Letters in this group may come from any family. Use italic letters to add emphasis to information or the impression of speed. Italics work well in any layout.

Contemporary letter group

The contemporary letter group includes hundreds of modern letters. These modern faces represent stylish alterations to traditional letters influenced by fashion and taste. Contemporary letters are used chiefly in display composition. Two letter styles in the contemporary letter group are the sans serif letter and the square or slab serif letter.

SAN SERIF: Sans serif letters are similar to the gothic letter style but are even in weight. Sans serif letters have perfect geometric proportions and have no flourishes.

Figure 5-26 is example of sans serif letters in the contemporary letter group.

FUJIYAMA Extra Bold

DMV30263

Figure 5-26.—A contemporary san serif letter style.

SQUARE or SLAB SERIFS: Square or slab serif letters may have the same even strokes as the sans serif letter or have thick and thin main stems with serifs terminating the letter. The serifs resemble a square or block.

Figure 5-27 is examples of square or slab serif contemporary letters.

MEMORANDUM

DMV30264

Figure 5-27.—A contemporary square- or slab-serif letter style.

Letter Strokes

Introduction

Lettering is not like handwriting. With practice, you can learn to letter well and legibly even if your handwriting is not particularly good. The order in which you draw the strokes that form letters are as important as the individual letters themselves. How you execute the strokes and in what order will affect the ease and rapidity of your lettering.

Strokes

Strokes are the vertical, horizontal, and curvilinear movements made by your hand as you draw letters. Strokes are made with a coordinated arm, wrist, and finger action. Vertical and slanted strokes are made by drawing the stroke toward you. Horizontal strokes are made from left to right. Curved strokes are made by rolling the drawing implement with the fingers in the direction of the stroke. All letters follow the same basic sequence of execution. Some letters require a combination of all strokes.

| Step | Action |
|------|--|
| 1 | Draw the vertical strokes. |
| 2 | Turn the drawing tool sideways and draw the horizontal strokes. |
| 3 | Make the left half of any curved letter first. Hold the drawing tool between the thumb and forefinger and twirl the drawing tool in the direction of the stroke as indicated in figure 5-28. |
| 4 | Connect any curves as required to finish the letter. |

Figure 5-28 illustrates the sequence for making basic lettering strokes.

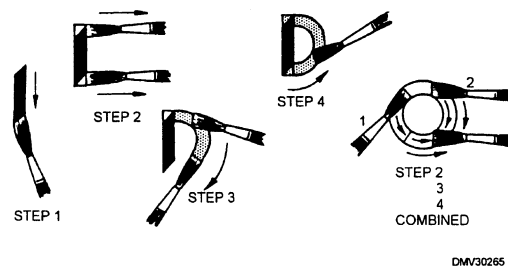

Figure 5-28.—The sequence for making basic lettering strokes.

Continued on next page

Letter Strokes, Continued

Practice lettering strokes

The carpenter's pencil is the ideal tool to practice the solid stroke of the gothic alphabet, the thick-and-thin strokes of the roman-style alphabet, and script letters. Sharpen the carpenter's pencil to a square chisel point. Sit comfortably with your work directly in front of you. Do not twist or turn your hand as the strokes turn. There are six basic lettering strokes that combine to form all letters. Practice these strokes individually, then combine strokes to form letters.

Figure 5-29 shows the six basic lettering strokes.

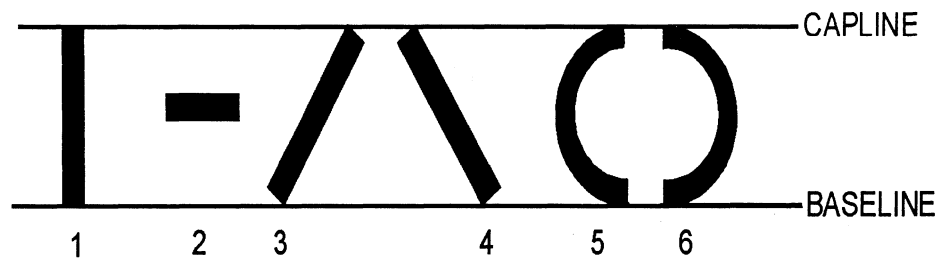

DMV30266

Figure 5-29.—Six basic lettering strokes.

Continued on next page

Letter Strokes, Continued

Basic strokes of gothic letters The letter style created by solid strokes with little variation in letter width is the gothic style.

Figure 5-30 shows the six basic strokes and how they combine to form letters in the solid stroke of the gothic style.

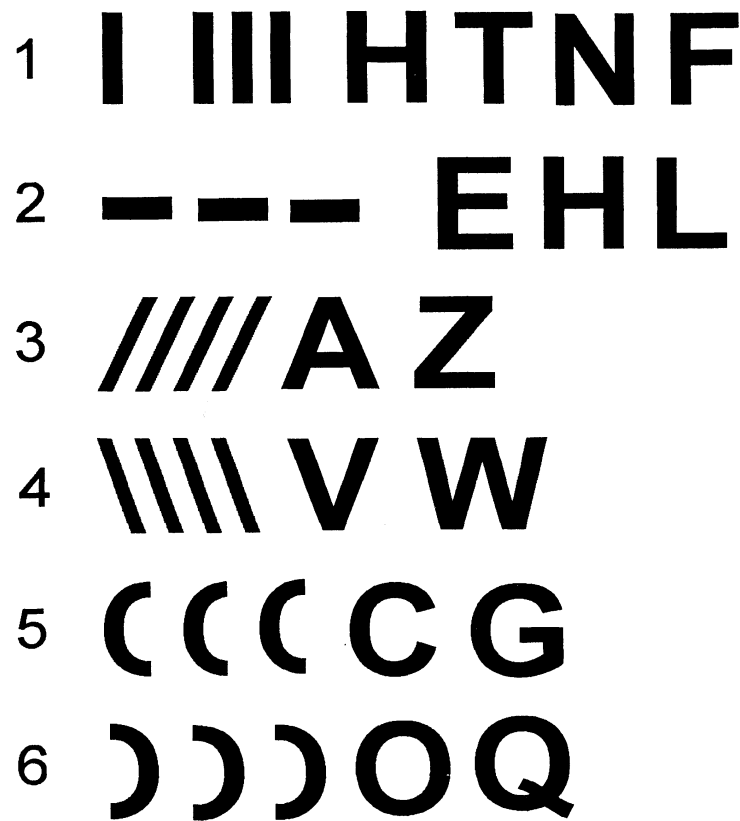

DMV30267

Figure 5-30.—Six basic strokes of letter gothic.

Continued on next page

Letter Strokes, Continued

Basic strokes of roman-style letters

Roman-style letters are thick-and-thin letters without extensive ornamentation; therefore, it is a good alphabet to begin hand lettering. Hold the carpenter's pencil so that the square-chiseled point makes an approximate 30-degree angle to the lettering guidelines. Practice the six basic strokes of hand lettering. Notice that the pencil lead automatically makes the strokes thick or thin based on the direction of stroke. Once comfortable with the basic strokes, begin combining strokes to form letters.

Figure 5-31 shows the six basic strokes, the sequence, and the direction each stroke is made to form the roman-style alphabet.

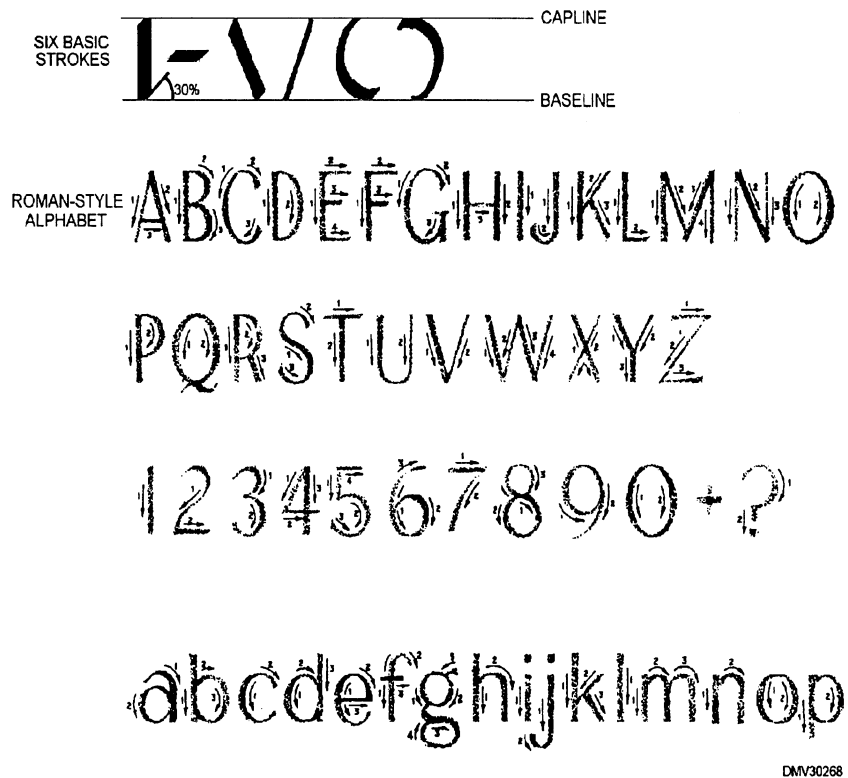

Figure 5-31.—The six basic strokes in the formation of the roman-style alphabet.

Continued on next page

Letter Strokes, Continued

Basic strokes of script

Script letters are based on handwriting. The letter forms made by the six basic strokes are rounded and flowing. One letter leads into another with hairlines that sweep up to join main stems. These hairlines are called kerns. Kerns should join the main stems at exactly the same height on every stem. The angle kerns form at letter stem bases should be uniform. To make kerns, allow your stroke to suddenly and decisively sweep up toward the position of the next letter stem. This upward sweep forms the curve at the bottom of the stem. Do not expect to complete the kern in one action. Draw the main stem of the next letter. Return to the stem of that letter and with one downward stroke, draw a hairline to meet the kern extending up from the base of the previous letters stem.

Figure 5-32 illustrates the steps for drawing kerns in script lettering.



Figure 5-32.—Steps for drawing kerns in script letters.

Letter Compositions

Introduction

The overall effectiveness of your work depends upon its composition. To determine the proper arrangement of lettering, use standard rules of design. Lettering compositions may be formal or informal.

Compositions

How you compose lettering on layouts directly contributes to or detracts from the intended message. Lettering should be an integral part of the composition, not added after the main art is done. Once you have all the information for the layout, begin brainstorming ideas that fit the attitude of the message. Sketch several possible layouts. These sketches may be comprehensive or rough so long as you can evaluate the effectiveness of the composition. These preliminary layouts are called thumbnail sketches. Thumbnail sketches prevent having to redo work because the lettering will not fit or appears awkward.

Figure 5-33 shows how even rough thumbnail sketches are invaluable for assessing an effective composition.

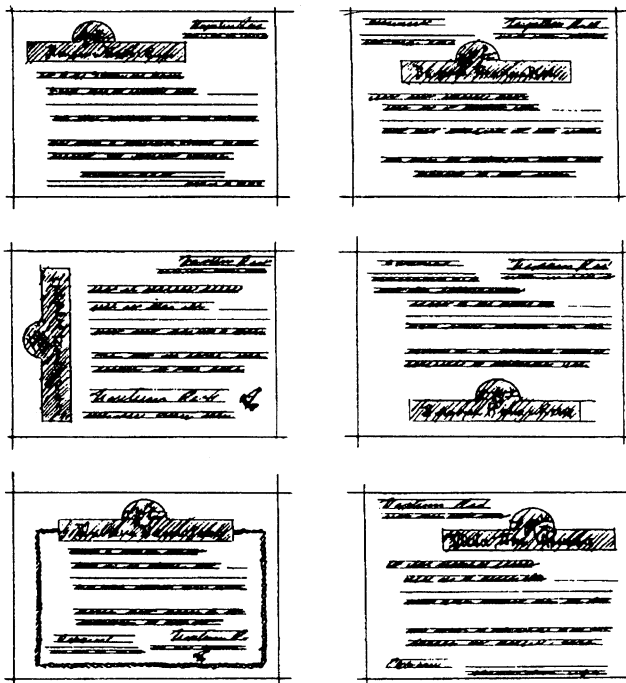

DMJA0019

Figure 5-33.—Thumbnail sketches.

Continued on next page

Letter Compositions, Continued

Formal lettering composition

Formal lettering compositions are compositions that follow rigid rules of design. Intended primarily for serious or dignified layouts, formal lettering compositions present letters in centered, flush left, or flush right positions. Lettered information often appears as pyramids or inverted pyramids placed one-tenth page length above the exact center of a page. This elevated position is referred to as optical center. Any element placed at the optical center of a page will receive maximum attention, while letters placed at the exact center appear as if they were below the center of the page.

Figure 5-34 shows examples of formal lettering layouts.

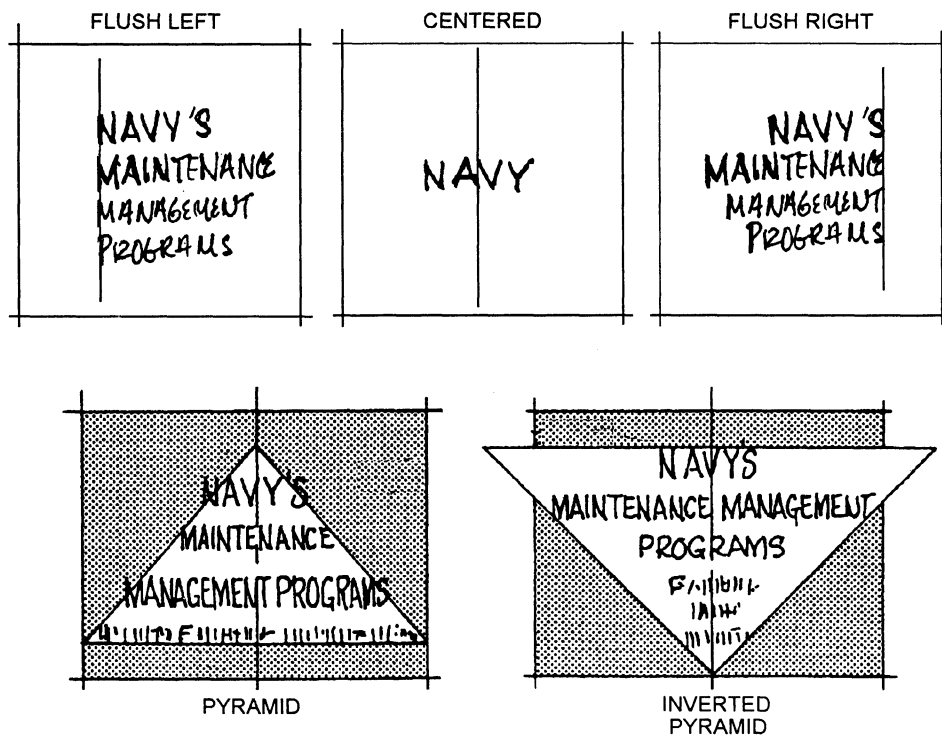

DMV30271

Figure 5-34.—Formal lettering layouts.

Continued on next page

Letter Compositions, Continued

Informal lettering composition

Informal lettering compositions make use of off-center arrangements to add interest, freshness, and motion to copy. Elements are arranged so that the eye is naturally led from one element to another. Eye-leading arrangements are particularly important in display work. In spite of their casual appearance, the elements of the layout are arranged in an visually balanced order.

Figure 5-35 shows examples of informal lettering layouts.

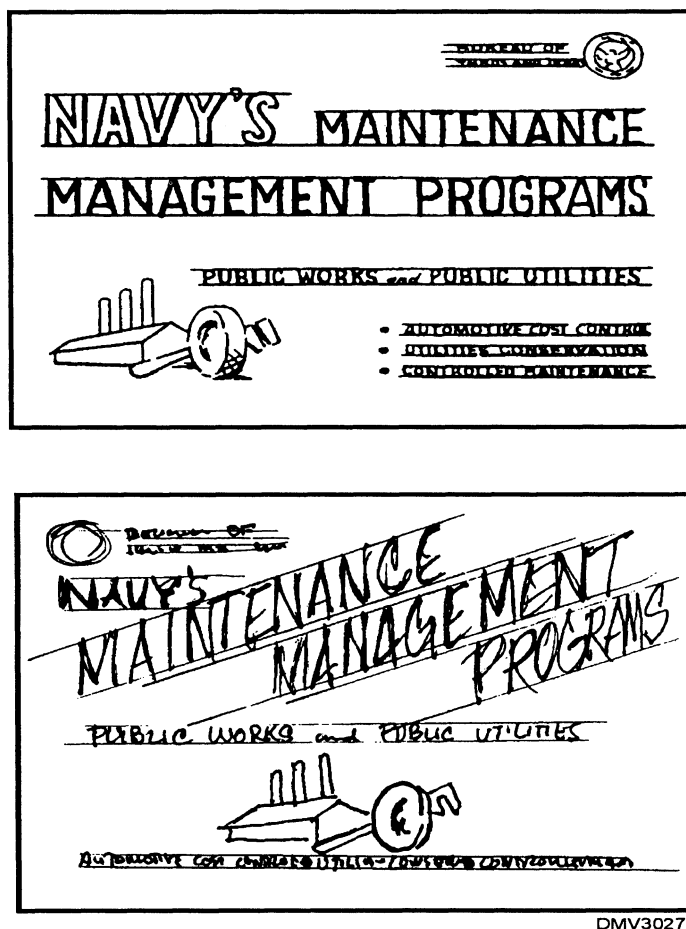

DMV30272

Figure 5-35.—Informal lettering layouts.

Continued on next page

Letter Compositions, Continued

Legibility

Legibility is a primary concern in the selection of letter style and the layout of lettering on a page. Factors having the greatest bearing on legibility are the style and size of the letter and the space between letters, words, and lines of lettering.

STYLE: Open, clean-cut letters, simply designed, provide maximum legibility. On projects that do not require specific letter styles, style selection is left to the DM. When composing layouts with extensive amounts of lettering, limit the selection of letters to no more than three different styles to avoid a haphazard appearance or visual overload. Use different letter sizes to subordinate some information to other information when you have a great amount of lettering.

Figure 5-36 shows how to subordinate letters of the same style to primary text.

Saufley Field
Command Picnic — PRIMARY
26 JULY 1997 — SECONDARY

DMV30273

Figure 5-36.—Subordinating secondary information to primary information using type size.

Continued on next page

Letter Compositions, Continued

Legibility (Continued)

SIZE: Letter size affects how easily text is read. Inappropriately small letters strain the viewer's eyes and patience and will likely not be read. Limit lettering to essential information. Limit lettering on art intended for viewgraphs or slides to approximately 8-10 words per frame. If letter size is set, change the x-rating of the letter to improve legibility without changing letter size or style.

SPACING BETWEEN LETTERS: To give words the appearance of having uniformly spaced letters, make the areas between letters nearly equal. Equal spacing between letters is called *mechanical spacing*. Sometimes equal amounts of space between letters create too much white space and breaks up the appearance of the word. If this occurs, reexamine the areas between adjacent letters and increase or decrease them accordingly. Arbitrarily adjusting space between letters based on overall appearance is referred to as *optical spacing*. *Letterspacing* refers to the addition of space between letters. Letterspacing makes short words or titles appear longer. Decreasing space between letters is called *kerning*.

Figure 5-37 illustrates the difference between mechanical spacing and optical spacing.

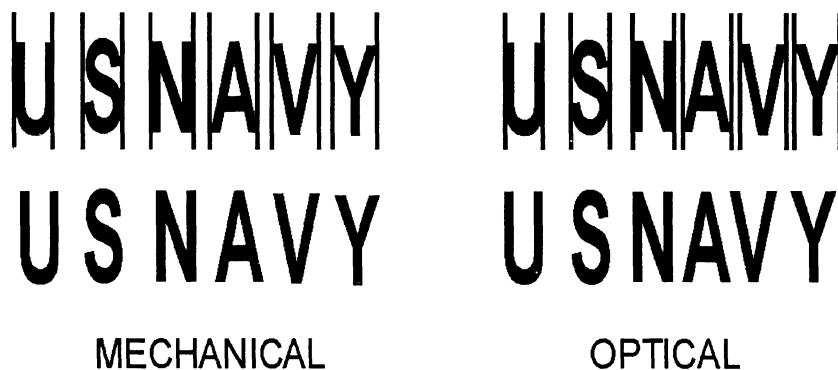

DMV30274

Figure 5-37.—Mechanical and optical spacing.

Continued on next page

Letter Compositions, Continued

Legibility (Continued)

Areas between adjacent letters vary according to the shape of the letter and of the previous letter. Draw adjacent straight-sided letters (such as H, I, M, N) farther apart. Draw adjacent rounded letters (O, Q, C, G) and slanted letters (A, V, W) closer together. Where open letters (L, T, J) are beside slanted letters, the top of one may be drawn above the bottom of the other to avoid spaces that appear like breaks in the word. Refer to the following chart for general corrections to common letterspacing problems.

| Problem | Correction | Reason |
|--|-------------------|--|
| Round beside round (OOOOOOOOOO) | Decrease space | Spacing appears greater where letters curve away from each other |
| Round beside slant (OVOVOVOVOV) | Decrease space | Spacing appears greater where letters move away from each other |
| Round beside vertical (OIOIOIOIOIOI) | Decrease space | Spacing appears greater where round letters curve away |
| Vertical beside vertical (HIHIHIHIHIHI) | Increase space | Spacing appears less at the top and bottom, particularly if serifs are present |
| Vertical beside slant (HVHVHVHVHV) | Decrease space | Spacing appears greater at the top and bottom where letter slant away from the other |
| Slant beside slant (AVAVAVAVAV) | Decrease space | Spacing appears greater at the top and bottom particularly if the letters slant away from each other |

Continued on next page

Letter Compositions, Continued

Legibility
(Continued)

Figure 5-38 illustrates common spacing problems.



Figure 5-38.—Common spacing problems.

WORD SPACING: Word spacing is the spacing between words. Allow enough space between words and sentences to keep them from running together. A good practice to follow is making the space between words equal to the space the letter “O” occupies.

Figure 5-39 illustrates word spacing using the letter “O.”

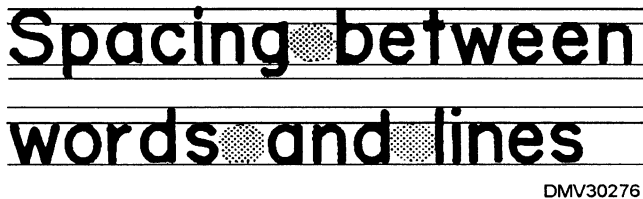

Figure 5-39.—Using the letter “O” to space between words.

Continued on next page

Letter Compositions, Continued

Legibility (Continued)

LINE SPACING: Line spacing is the space between lines of lettering. Line spacing may also be called leading. The distance between lines of lettering should not be exactly the same dimension as letter height, but there should be enough air space between lines of lettering to make it easy to read. The space between lines may vary from $\frac{1}{2}$ to $1\frac{1}{2}$ times the height of the letter. Generally, a good distance for space between lines of lettering is two-thirds letter height. This leaves sufficient space for ascenders and descenders.

Figure 5-40 shows different line spacing.

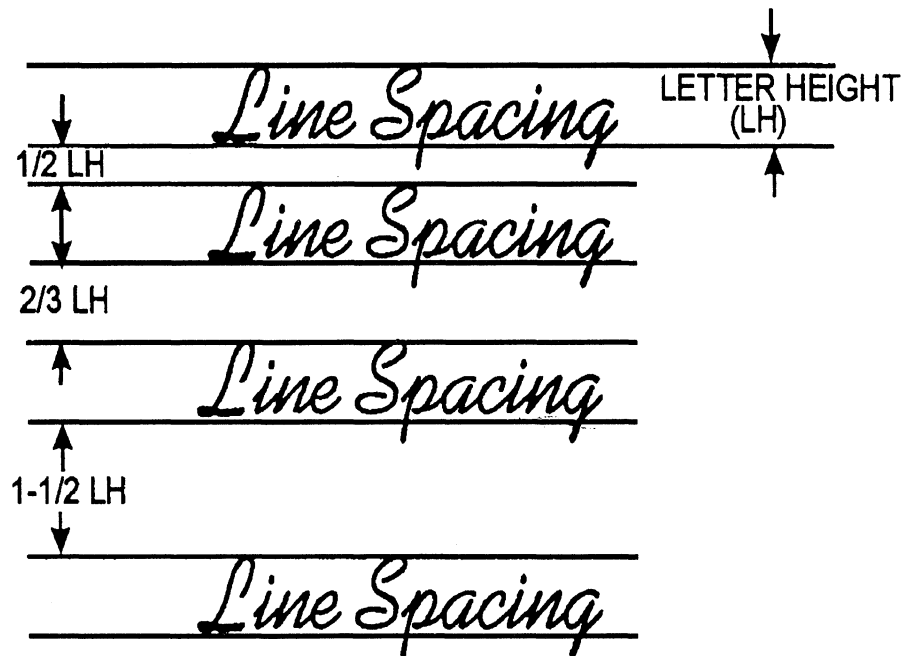

DMV30277

Figure 5-40.—Letter spacing or leading.

Continued on next page

Letter Compositions, Continued

Centering

Centering letters, in both formal and informal page layouts, presents a pleasing and easily understood hierarchy of information. Since the letters of an alphabet vary in width, the location of the first and last letters of words you want to center is difficult to project. There is more than one method for centering letters on a page. One method of centering letters on a page is to letter a piece of scrap paper, fold the paper in half to find the centerline (CL), and transfer the letters to the original.

Figure 5-41 illustrates how to find the center of a lettered piece of scrap paper.

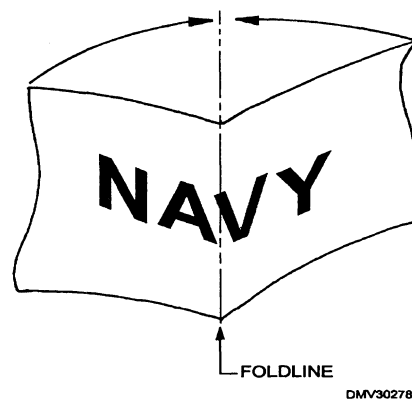

Figure 5-41.—Folded scrap paper locates centerline.

Another method of centering letters on a page involves counting the number of characters on a line and dividing them in half. Punctuation, lower case "l," and the letter "i," in both upper and lower case, count only as $\frac{1}{2}$ a letter because they take up less space.

Figure 5-42 illustrates the counting method of centering words.

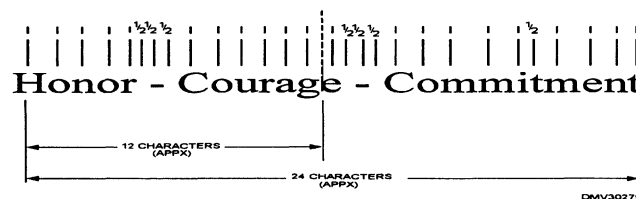

Figure 5-42.—Counting characters to center words.

Continued on next page

Letter Compositions, Continued

Justification

Justification is an adjustment in spacing that makes lines of lettering equal in length regardless of the number of characters per line. Each line starts and stops on the same margin line as every other line. Although symmetrical in appearance, overuse of this technique becomes monotonous.

Figure 5-43 shows three lines of type justified.

Tradition, valor, and victory are the Navy's heritage from the past. To these may be added dedication, discipline, and vigilance as the watchwords of the present and the future. Never have our opportunities and responsibilities been greater. Service to God and Country is our special privilege. We serve with honor.

DMV30280

Figure 5-43.—Justification.

Flush left or right

Lettering set flush left or right have a common beginning (flush left) or end (flush right). Flush set lettering is very effective and offers an asymmetrical balance more typical of informal lettering layouts.

Figure 5-44 shows how lettering set flush left or right enhance informal lettering layouts.

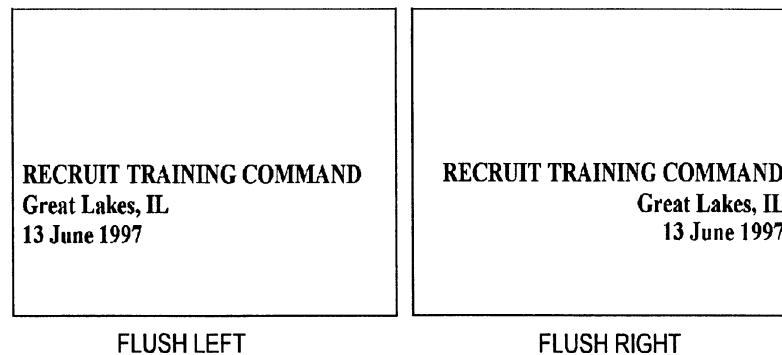

DMV30281

Figure 5-44.—Flush set lettering.

Continued on next page

Letter Compositions, Continued

Overlapping letters

Overlapping letters is a valid design concept particularly with informal lettering layouts. When overlapping letters, take care not to overly deform the integrity of the letters and render them illegible. Allow enough letter form to remain so that the eye can fill in the remaining parts and identify the letter.

Figure 5-45 is an example of properly overlapped letters.



DMV30282

Figure 5-45.—Properly overlapped letters.

Negative letters

Letters rendered in negative format are simply letters where the space around them is filled in and the letters themselves appear empty. Negative letters are more appropriately suited to informal lettering layouts.

Figure 5-46 shows a negative letter format.



DMV30283

Figure 5-46.—Negative letters.

Lettering Mediums

Introduction

The style of lettering is directly influenced by the tools used to produce it. The type of tool you use determines the type of paper you select to letter on. Selecting a tool compatible with the paper surface makes the job of lettering much easier.

Lettering surfaces

Lettering surfaces include a great variety of papers and surfaces such as posterboard, masonite, and plywood. When selecting paper for pen and ink lettering, choose a smooth-surfaced bristol board. Medium and rough surfaced bristol or paper is more suited to paints and brushes, pencils, pastels, charcoal, crayon, and felt-tipped pens. When selecting more rigid substrates like metals and woods, prepare the surface with multiple base coats of paint and lightly sand surfaces smooth in between coats. A smooth surface allows the brush to deposit paint without drag, which causes ragged letters.

Media

The purpose of the finished product dictates the media and tool you letter with. Finished letters should be sharp, clean, and opaque. Pencils, pen and ink, paints and brushes, and chalks, crayons, pastels, and felt-tipped pens are all common tools capable of producing a finished letter.

Figure 5-47 are common lettering tools.

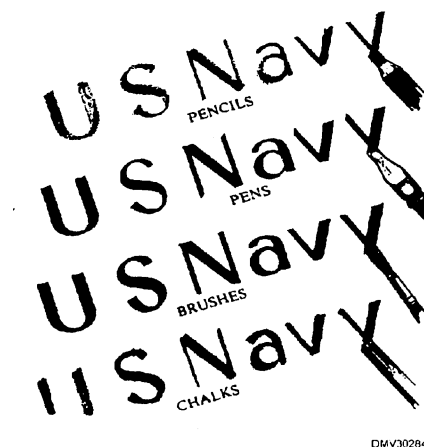

Figure 5-47.—Common lettering tools.

Continued on next page

Letter Mediums, Continued

Pencil letters

Lettering pencils should produce dense black strokes. Select hard lead pencils for papers with tooth. Soft lead pencils are better suited to smooth surface papers, but lead should not be so soft that it requires continued sharpening. For large letters, use carpenter's pencils sharpened to a square chiseled point. Hold the pencil with the thumb, forefinger, and second finger of the hand in a normal writing position. Place the lead of the pencil at a 30-degree angle to the letter guidelines. Experiment with a number of different pencil grades to find a pencil you can use comfortably.

Figure 5-48 shows how to hold a carpenter's pencil when you letter.

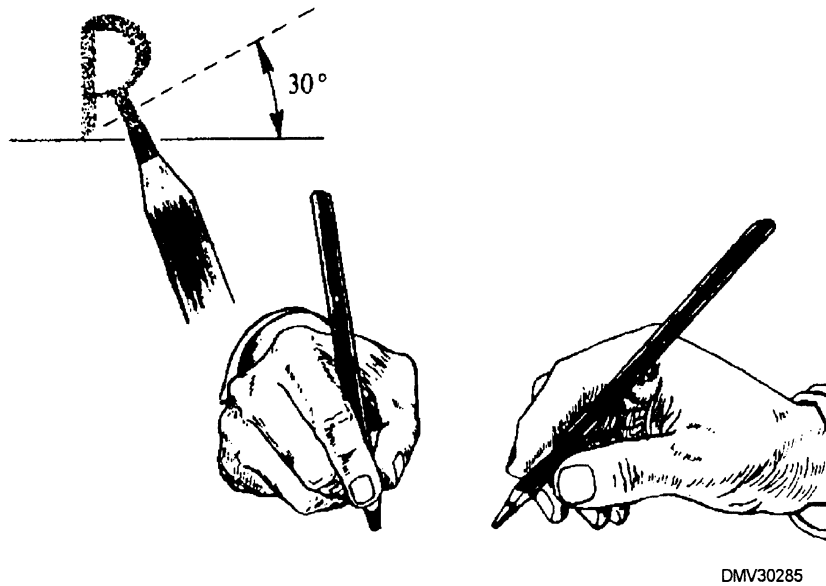

Figure 5-48.—Holding a carpenter's pencil to letter.

Continued on next page

Letter Mediums, Continued

Pens and ink letters

Pens and ink produce dense black, opaque strokes. Pens have differently shaped nibs that determine how easily serifs will execute. Standard lettering nibs are used for letters up to 72 points in height. Larger letters require especially large nibs. Left-handed DMs will want to purchase pen nibs particularly suited to left-handed letterers. These nibs have angled tips cut opposite to standard lettering pens. Hold lettering pens as you would pencils. Do not grip the handle too tightly or you lose the sense of feel necessary to execute proper letter forms. Wipe nibs often with soft tissue to remove paper fibers that cause ragged edges. Always follow manufacturer's instructions for cleaning before putting pens away.

Figure 5-49 shows different types of lettering nibs.

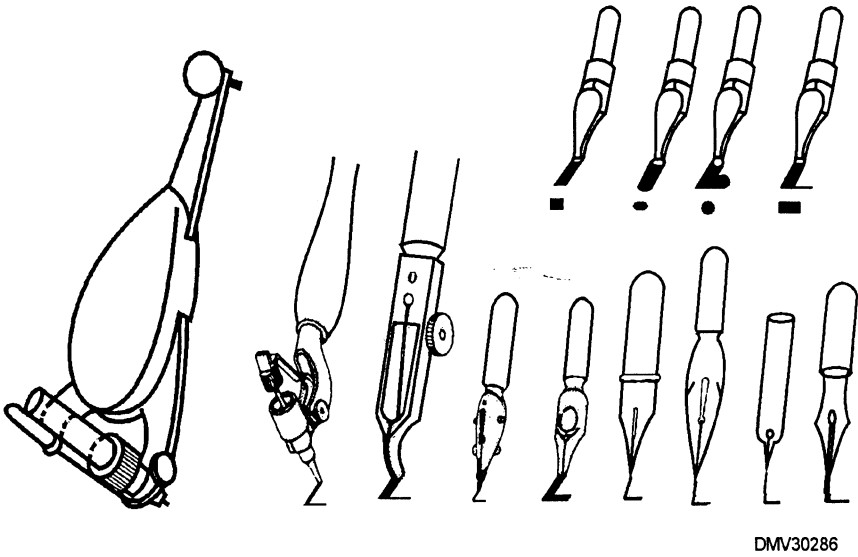

DMV30286

Figure 5-49.—Lettering nibs.

Continued on next page

Letter Mediums, Continued

Brush letters

Lettering with brushes requires more skill and patience than lettering with pens. Two types of brushes are common to lettering. One type brush is red sable brushes with round ferrules and square tips ranging in size from very small (No. 1) to very large (No. 24). This brush is called a rigger. The second type of preferred brush is red sable brushes with flat ferrules ranging in size from small (1/8 inch) to large (1 inch). Choose a brush size equal to the desired width of the stroke. You may hold brushes in the same way you hold pencils or you may use a two-finger grip on the middle of the ferrule. The brush bristles should form approximately a 90-degree angle to the lettering surface.

Figure 5-50 shows a brush held 90 degrees from the lettering surface with a two-finger grip.

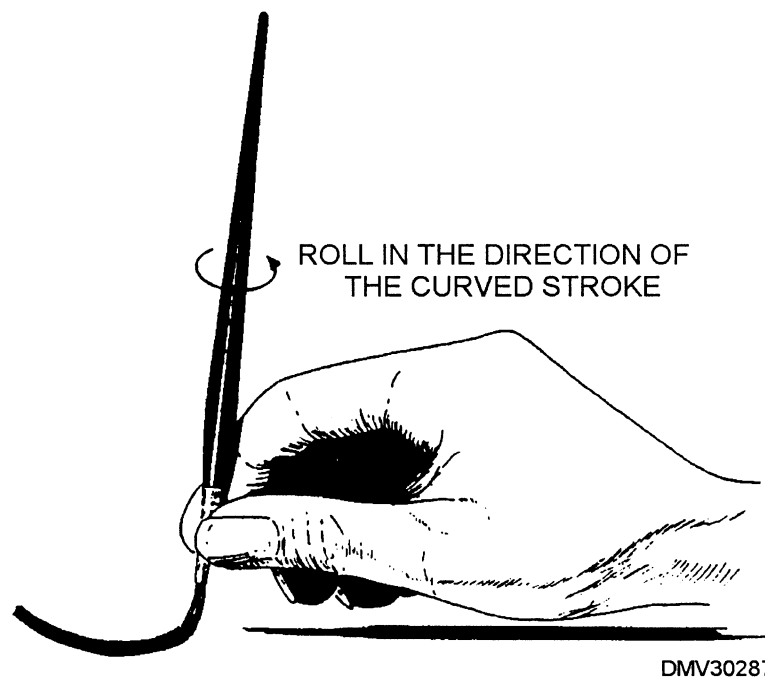

DMV30287

Figure 5-50.—A rigger brush held with a two-finger grip.

Continued on next page

Letter Mediums, Continued

Brush lettering (Continued)

For more stability when hand lettering, use a sign painter's mahlstick to brace the lettering hand over the surface. A mahlstick is a long stick with a rubber tip to prevent sliding that supports a sign painter's wrist above the lettering surface.

Figure 5-51 illustrates how to use mahlsticks.

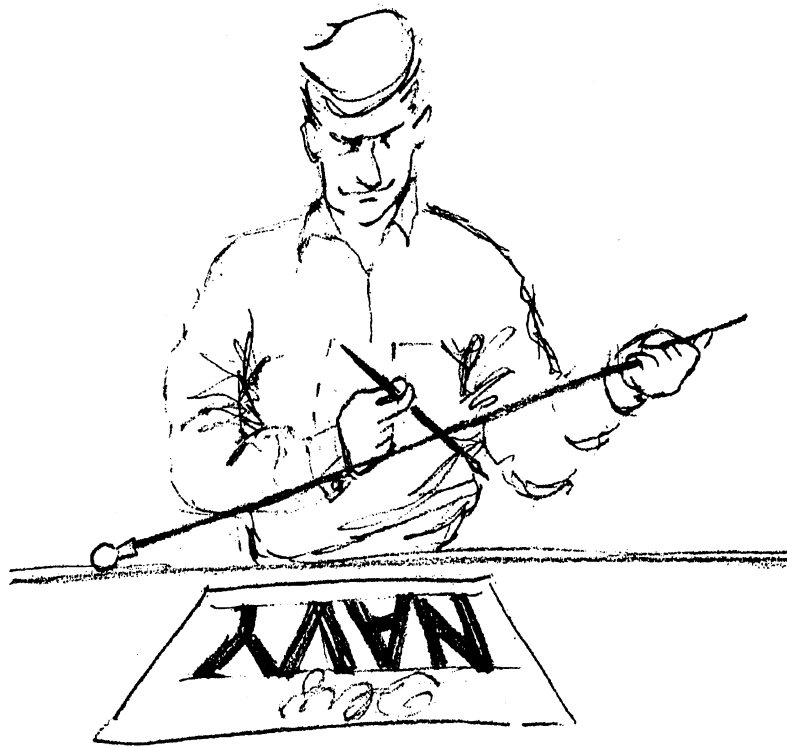

DMV30288

Figure 5-51.—Using a mahlstick.

Continued on next page

Letter Mediums, Continued

Brush letters (Continued)

To prepare brushes for lettering, load the brush with pigment and palette the brush back and forth across a piece of scrap paper. Form each stroke with the tip of the brush. Make sure the brush has a sufficient amount of pigment and that the pigment is properly positioned near the flags or tip of the brush.

Figure 5-52 illustrates how to palette brushes to position the load of pigment near the flags.

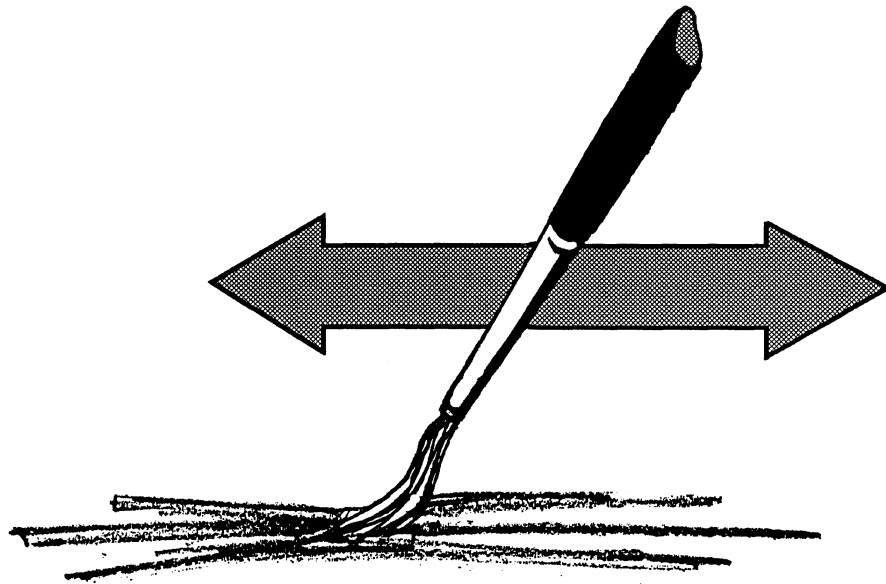

DMV30289

Figure 5-52.—Palette brushes to position paint.

Continued on next page

Letter Mediums, Continued

Chalk, charcoal, pastel, and felt- tipped pen letters

Letters made with chalk, charcoal, pastel, and felt-tipped pens are similar in execution to letters created with pencils. A wide variety of colors are available. When you use the sides of the chalk, charcoal, and pastels, it creates wide strokes. When you use chalk, charcoal, and pastels, spray fixative over the finished letters to prevent smudging and smearing. Felt-tipped pens come with small, medium, and large tips. Some markers specifically designed for lettering already have angled tips or split tips. Paint markers that imitate brush strokes are also on the market. Check to make sure whether the marker you choose is opaque or transparent, waterproof or water soluble.

Figure 5-53 shows different tips on felt-tipped markers intended specifically for lettering.

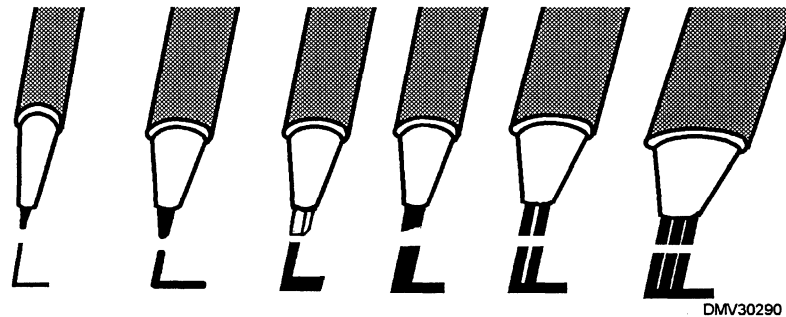

Figure 5-53.—Different lettering nibs on felt-tipped markers.

Lettering Aids

Introduction Several mechanical devices assist the DM in creating finished lettering suitable for display or reproduction. These devices include lettering guides, photolettering machines, and mechanical lettering devices.

Letterguides Letterguides are clear plastic templates pierced with holes that automatically lay out lettering guidelines. One of the most basic lettering aids available, letterguides eliminate the constant measurement of guidelines.

Lettering templates Lettering templates ensure that letters and figures made by them are absolutely uniform. There are two main styles of lettering templates. Letterspacing is accomplished optically. One style of templates is packaged as lettering sets consisting of a series of engraved templates with a groove along the bottom. Scribes, sometimes called bugs, fit a tailpin into the template groove and trace letters on the template with a tracer pin to the paper surface. Only technical pens with conical tips fit the scriber pen holder. Do not apply an excessive amount of hand pressure when you are lettering. This causes the pen to dig into the paper surface.

Figure 5-54 shows a template and scriber.

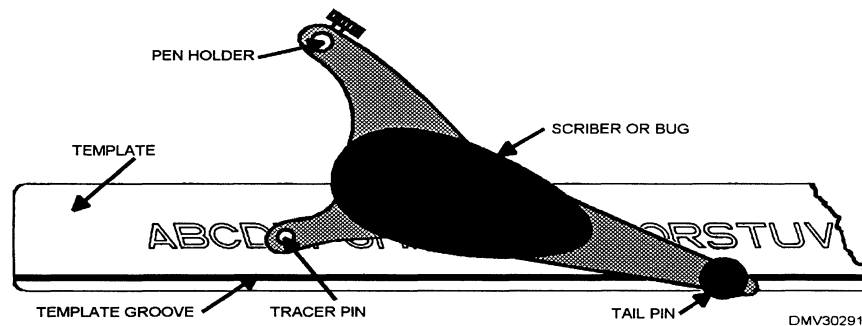

Figure 5-54.—A template and scriber.

Continued on next page

Lettering Aids, Continued

Lettering templates (Continued)

The second set of lettering templates have letter forms cut directly out of the template. The DM traces the letter form in the template onto the paper surface. Technical pens with either conical or tubular tips may be used in the template.

Figure 5-55 shows a lettering template with letter forms cut out.

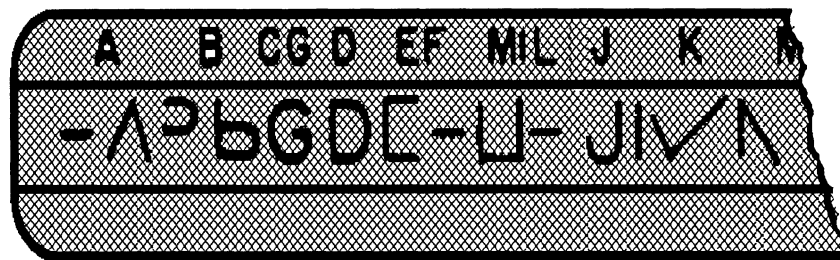

DMV30292

Figure 5-55.—A lettering template with forms cut out.

Continued on next page

Lettering Aids, Continued

Photolettering devices

Photomechanical lettering devices use the principles of photography to produce uniform letters. Most photolettering machines control font selection, letter size, line length, letter density, word, line, and letter spacing, type position, and leading. Some devices produce display as well as body type. The output of photolettering devices is strips or pages of black letters on white paper or film.

Computer-generated letters

Letters produced by computers are uniform and dense when printed with laserjet printers. Letters produced on dot matrix printers are not suitable as finished lettering. You may compose the layout of the finished product on the computer screen, or you may cut and paste the letters together later. Difficulty arises when your requirements exceed the capability of the software in the computer. Remember, the definition of point size in the printing industry is very different from the definition of point size in the computer arena. Computers may also refer to letter size in pixels. Both points and pixels in the computer language are much smaller and do not equate to the printing industry definition.

Figure 5-56 illustrates the great difference between a 72-point letter and a computer version of a 72-pixel/point letter.

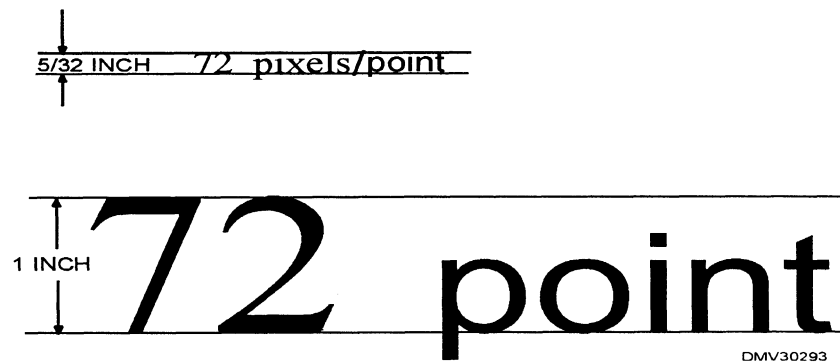

Figure 5-56.—The difference between a 72 pixel/point letter and a 72 point letter.

Continued on next page

Lettering Aids, Continued

Pressure process lettering devices

Pressure process lettering devices create letters you can cut and paste into place on layouts. Pressure process lettering machines may be automatic or manually operated. Automated pressure process lettering machines have a keyboard, limited memory storage, and a monitor. These lettering devices produce letters on strips of paper and film. Some papers and films are adhesive backed.

Transfer letters

Transfer letters are preprinted letters on adhesive-backed acetates sheets. The adhesive is a repositionable, wax-based adhesive that allows some latitude in positioning letters until burnished over the acetate surface with a burnisher. Some transfer letters require cutting the acetate around the letter and burnishing the patch onto the layout. Transfer lettering that requires cutting is similar to paste up lettering. The major disadvantage to transfer letters is the tendency to run out of frequently used letters.

Figure 5-57 shows examples of transfer letters.

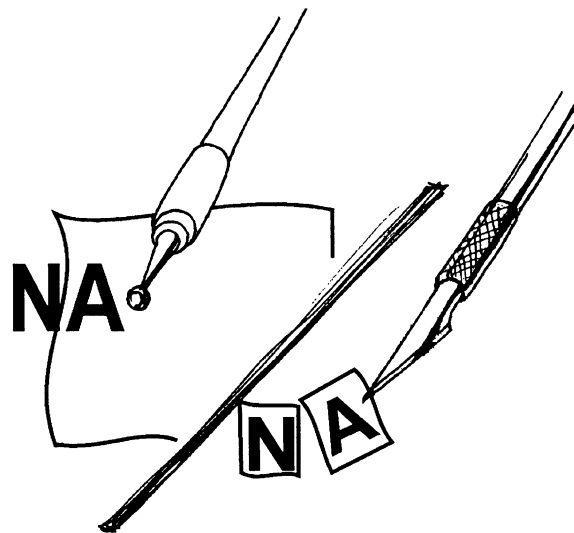

DMV30294

Figure 5-57.—Transfer letters.

Calligraphy

Introduction Calligraphy is a special artform. International organizations exist to promote calligraphic skills. Calligraphy is having a resurgence in popularity. Even with poor handwriting skills, you can develop a serviceable calligraphic hand that will prove valuable in your career as an Illustrator Draftsman.

Calligraphy Calligraphy is the art of beautiful hand lettering. Although letter styles have geometric standards, an individual's personal taste, style, and creativity alter static letter forms to impart life and vitality into letters. For further study of calligraphy, study the work of world renown calligraphers such as Sister Jeannine Klemm, OP, Margaret Shephard, and Scott Kim.

Calligraphic terms In addition to referring to capital letters as uppercase, UC, or caps, calligraphic capitals are called majuscule letters. Majuscule letters decorated more ornately than letters in the body of text are called illuminated letters. Lower case or LC letters are called minuscule letters.

Figure 5-58 is an example of an illuminated letter.



DMV30295

Figure 5-58.—An illuminated letter.

Continued on next page

Calligraphy, Continued

Left-handed calligraphy

Left-handed DMs have slightly more difficulty in lettering. Left-handed DMs have three options that will make lettering easier to execute. The first option is lettering with the hand above the top of the paper. The second option is to purchase special pens with left oblique nibs and turn the sheet of paper slightly to the left. Lastly, left-handed DMs may use the same nib right-handers use but may need to turn the sheet of paper 90-degrees clockwise. Write from top to bottom taking care not to smear previously executed letters.

Figure 5-59 illustrates the different lettering options open to left-handed letterers.

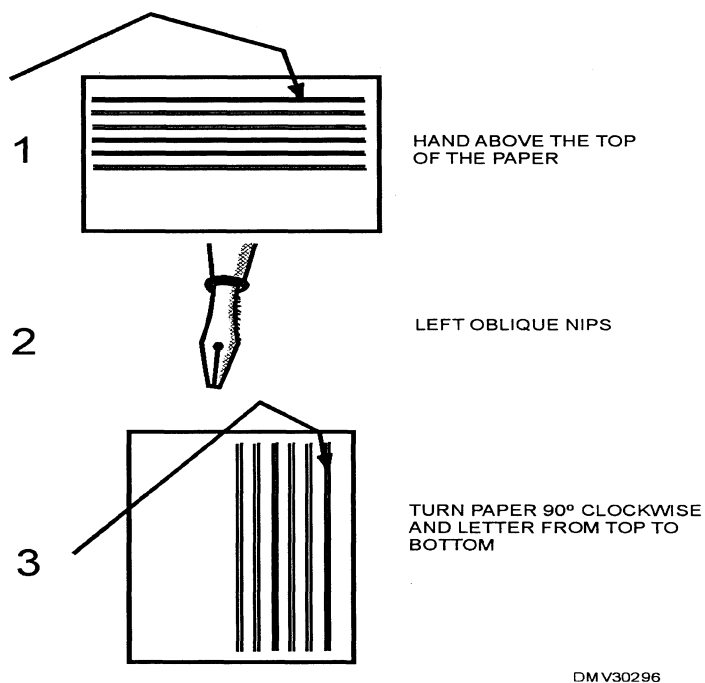

Figure 5-59.—Lettering options for left-handed letterers.

Continued on next page

Calligraphy, Continued

Holding the pen Let the pen rest on the knuckle of your middle finger and hold the pen with your thumb and forefinger. Your forefinger should remain arched. If your forefinger straightens, you are pressing too hard. There should be very little pressure of your fingers on the penholder, between the pen nib and the paper, and your hand on the tabletop.

Figure 5-60 shows how to correctly hold a lettering pen.

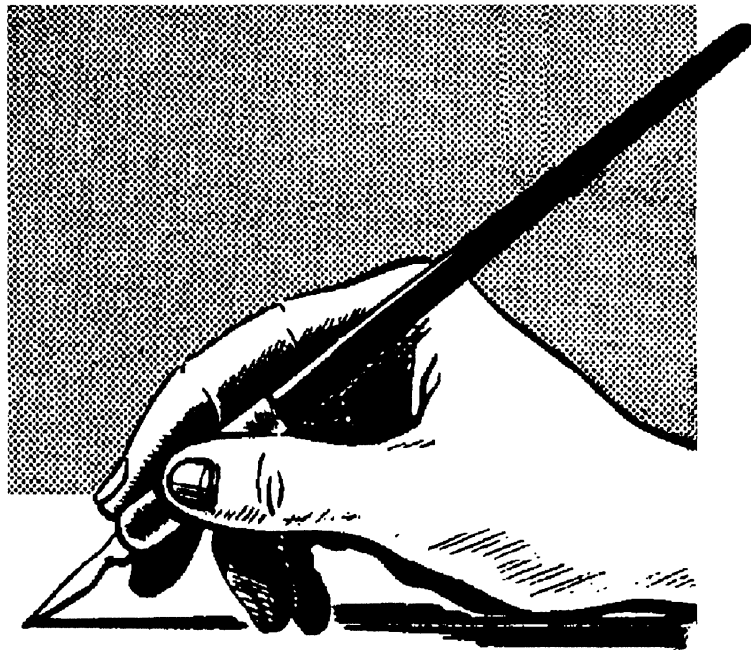

DMV30297

Figure 5-60.—Holding a lettering pen correctly.

Practice

There is no substitute for practice in calligraphy. It takes time to develop the forearm, wrist, hand, and eye coordination required to letter beautifully. Practice regularly. When tired or tense, stop practicing until more rested. Plan to practice uninterrupted.

Continued on next page

Calligraphy, Continued

Guidelines

Guidelines for calligraphy are the same as the guidelines for general lettering. There is a capline, baseline, waistline, line of ascent, and line of descent. Vertical guidelines or lines of inclination indicate the vertical orientation of letters. If you are lettering letters with kerns, you may want to add a branch line. A branch line uniformly indicates where kerns are to meet letter stems. Draw a branch line at an arbitrary distance between the waistline and baseline.

Figure 5-61 shows the placement and purpose of branch lines.

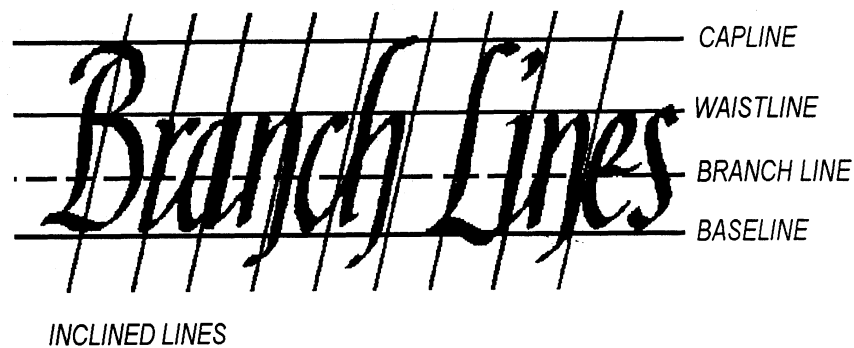

DMV30298

Figure 5-61.—The placement of branch lines.

Continued on next page

Calligraphy, Continued

Distance between guidelines

The distance between guidelines is determined by the width of the pen nib you intend to use to execute the letters. Penwidth is shown by lining up pen widths in a stack at the left side of the guidelines. The penwidth ratio for most letter styles is shown in figure 5-62.

Figure 5-62 illustrates penwidth distance for letter guidelines.

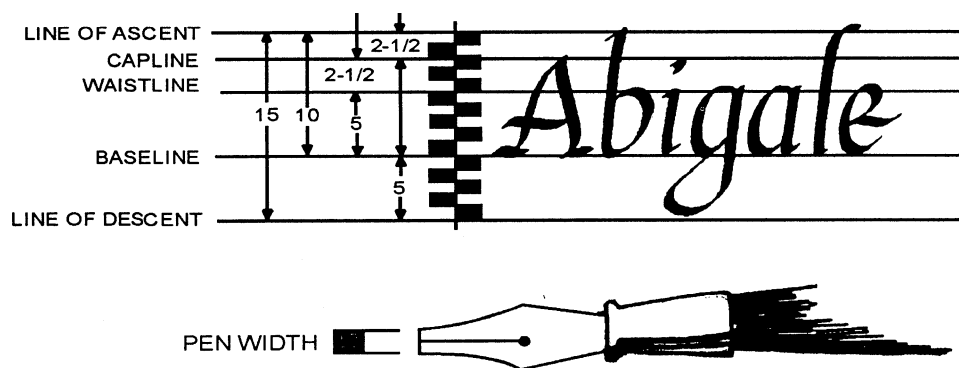

DMV30299

Figure 5-62.—Penwidth distance sets letter guidelines.

Continued on next page

Calligraphy, Continued

Basic strokes

Practice the six basic lettering strokes. All letters are some variation of these basic strokes. Get comfortable using the six basic strokes before attempting letters and words. Listening to music makes the task of repetitiously practicing the basic strokes less monotonous. As you practice, select the strokes in a sequence that reflects the rhythm of the music. You will soon realize that calligraphic lettering has a pattern and a rhythm of its own.

Figure 5-63 illustrates the practice of rhythmically practicing basic lettering strokes.

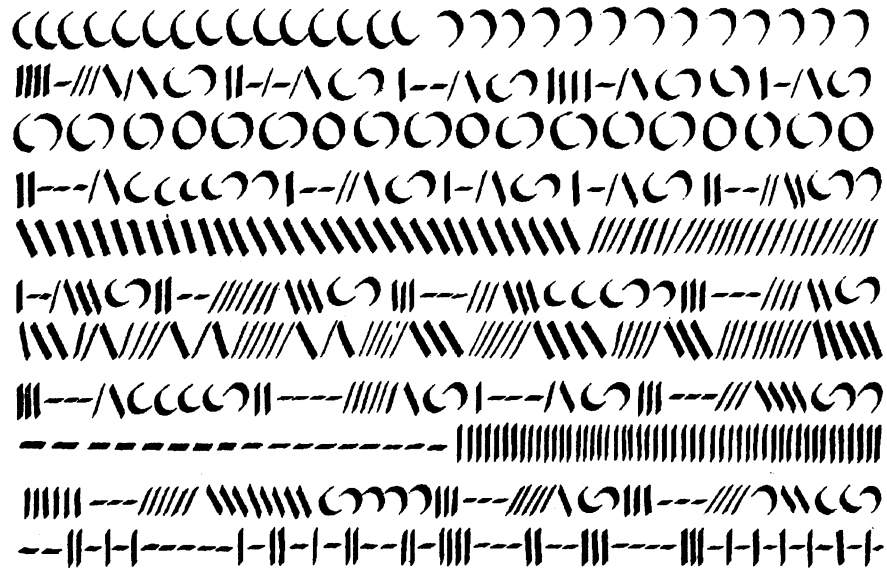

DMV30300

Figure 5-63.—A practice sheet of basic lettering strokes.

Continued on next page

Calligraphy, Continued

M-chain method

Practicing letter forms with a lower case “m” between each letter is called the m-chain method. When you are ready to begin creating letters, start by lettering lower case letters. In between each minuscule, place the lower case letter “m.” The letter “m” will accustom you to a sense of space around each form. Once comfortable with lower case letters, begin lettering the uppercase letters. Again, place a lower case “m” between each majuscule.

Figure 5-64 is an example of how practice sheets of the m-chain method should appear.

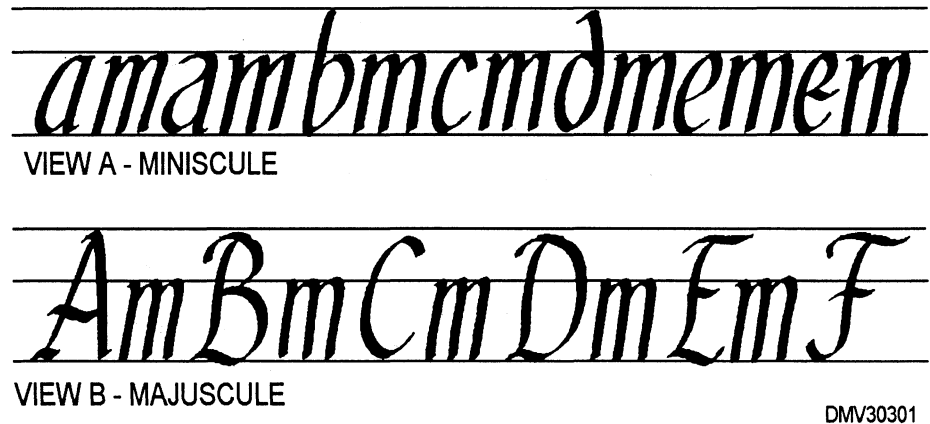

Figure 5-64.—M-chain practice sheets: A. Minuscule letters, B. Majuscule letters.

Continued on next page

Calligraphy, Continued

Progressing from the m-chain

Once you understand letter forms and the space they require, stop placing the letter “m” between the letters. As you draw each letter form, attempt to optically space individual letters beside each other. Starting with the letter “a,” repeat the letter until you have executed a correct form. Move to the next letter of the alphabet only after execution of a correct letter “a.” Progress through the entire alphabet and include the numbers 0 through 9. A good way of practicing without the m-chain is to copy manuscripts.

Figure 5-65 shows a practice sheet without the m-chain and a manuscript of lower case letters.

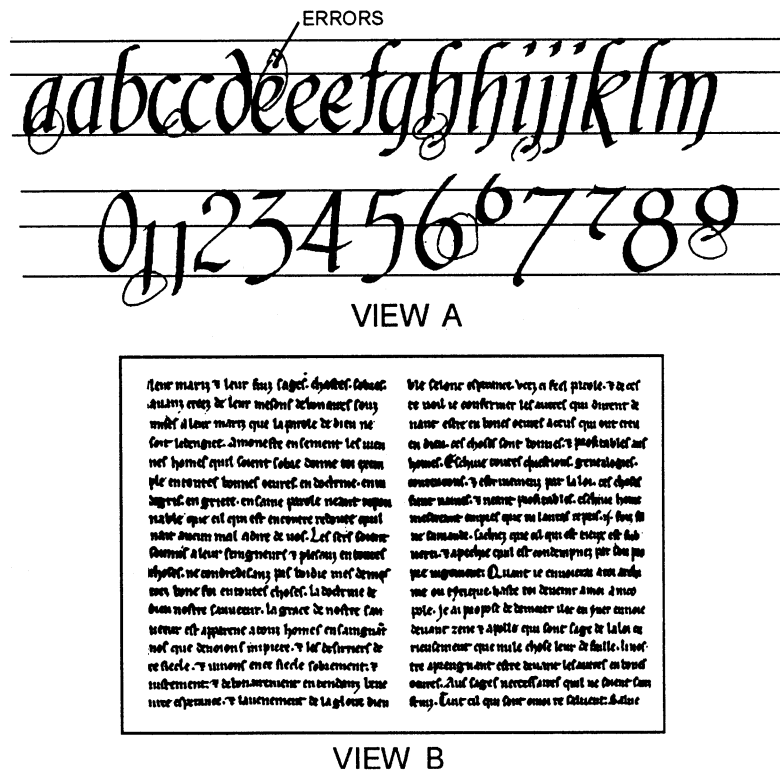

Figure 5-65.—A practice sheet: A. Without an m-chain, B. Manuscript copy. ^{DMV30302}

Continued on next page

Calligraphy, Continued

Forming words in sequence - returning to the m-chain

Forming words after extensive practice lettering lower case letters is a relatively easy progression. It is the spacing between words you have yet to understand and develop. Return to the m-chain, inserting the lower case letter “m” between each word. Once comfortable with the space that the letter “m” creates, stop using the m-chain for words.

Figure 5-66 shows practice sheets with and without the m-chain between words.

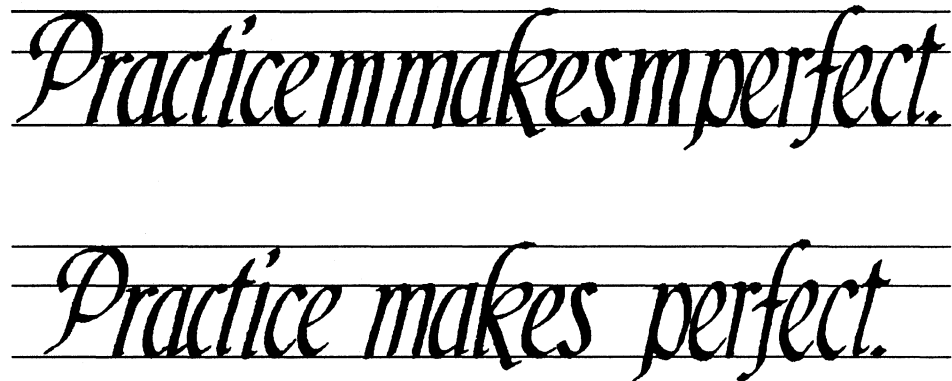

DMV30303

Figure 5-66.—Word practice sheets with and without the m-chain.

Continued on next page

Calligraphy, Continued

In-the-round lettering

Lettering in-the-round is letter forms in a circular format. Lettering in-the-round creates a whole new set of spacing challenges. Letters composed in a round format have spaces expanded at the top and condensed at the bottom of the letter. Begin by establishing a center point and drawing the basic guidelines as concentric circles. Draw the vertical guidelines as radii projecting from the center point of the circles the basic guidelines form. As you letter, rotate the paper so that the letter form you are currently creating is oriented to you as it would normally be.

Figure 5-67 illustrates the format for lettering in-the-round.

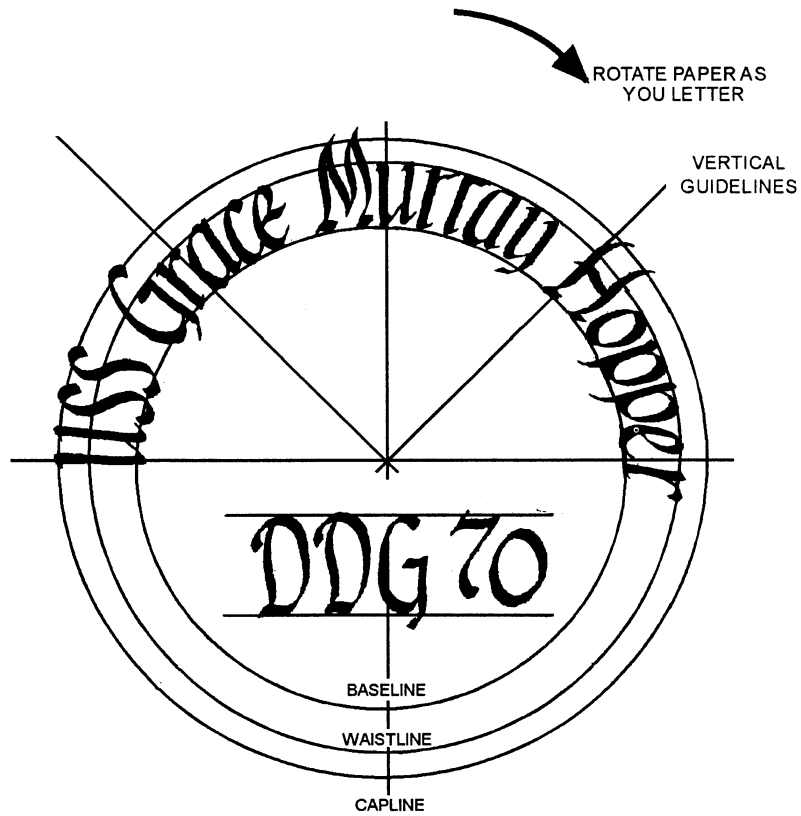

Figure 5-67.—Lettering in-the-round.

Continued on next page

Calligraphy, Continued

Variations

Once you learn the basic strokes, are able to create well-formed letters, and compose letters into words and phrases, you may begin the alteration of letter forms based on personal taste. Extend the serifs, change the geometric proportion of the serif to letter, or add extensive flourishes to letters to create a letter style of your own. Once you develop a personal letter style, create an entire alphabet, the numerals 0 through 9, and punctuation and record it as a style sheet for later reference.

Figure 5-68 is a style sheet for a letter form created with a felt-tipped pen.



DMV30304

Figure 5-68.—A style sheet for a letter created with a felt-tipped pen.

Summary

Review

This chapter covers lettering and calligraphy. Lettering terms are clearly defined. Lettering procedures are divided into manageable tasks such as drawing guidelines and practicing the six basic strokes. There is a brief discussion on letter classifications and their purposes. Lettering should be an integral part of the composition. Compositions containing letters in the layout deserve careful planning with an understanding toward formal and informal presentations. Lastly, there is an overview of calligraphy and its associated procedures and terminology from which the student should examine and develop lettering skills.

Comments

Throughout your career, one question that surfaces once someone finds out that you are a DM is, can you do those fancy letters? Everyone needs something lettered, be it a boat, car, or nameplate. One retired DM has a commercial business grossing more than \$300,000 a year by lettering. Sister Jeannine Klemm, OP, financed and maintained an art studio, print shop, and entire art-oriented wing of a private college through her work as a calligrapher. Local sign painters possess great hand lettering skills. Hang around and watch how the sign painter plies his craft. Learn from the experience. You can develop your lettering skills and enjoy the art form of calligraphy even if you do not have the benefit of learning from a world class master calligrapher.

CHAPTER 6

AIRBRUSH

Overview

Introduction

Airbrush art is a unique and meticulous art form that is experiencing a rebirth in popularity. Even if your shop does not have airbrush capabilities, chances are you use computer software programs with airbrush effects or occasionally use cans of spray paint. With a fundamental knowledge in the mixture of air and paint, it is possible for you to create art using the subtle effects only airbrushes or air painting can produce.

Objectives

The material in this chapter enables you to do the following:

- Identify airbrushes and airbrush component parts.
 - Install moisture traps and regulators to air sources.
 - Select pigments for airbrush illustrations.
 - Discuss the importance of comprehensive thumbnail sketches in airbrush illustrations.
 - Identify the procedures for varying background density in airbrush illustrations.
 - State the differences in paint application for creative effects.
 - Describe procedures for preparing photographs for airbrush retouching.
 - Learn how to remove or reduce unwanted backgrounds by silhouetting or vignetting with the airbrush.
-

Continued on next page

Overview, Continued

Acronyms

The following table contains a list of acronyms that you must know to understand the material in this chapter.

| Acronym | Meaning |
|----------------|------------------------|
| PSI | Pounds Per-Square-Inch |

In this chapter

This chapter covers the following topics:

| Topic | See Page |
|-------------------------|-----------------|
| Airbrushes | 6-3 |
| Component Parts | 6-11 |
| Maintenance | 6-15 |
| Airbrush Pigments | 6-20 |
| Preparing to Airbrush | 6-21 |
| Even Tones | 6-26 |
| Graduated Tones | 6-28 |
| Spot Effects | 6-30 |
| Metallic Effects | 6-32 |
| Special Effects | 6-35 |
| Basic Shapes | 6-40 |
| Pictorial Rendering | 6-45 |
| Technical Illustration | 6-51 |
| Photographic Retouching | 6-57 |

Airbrushes

Introduction

Airbrush art combines the graphic qualities of illustration with the continuous tones of photography. Although you may not have the opportunity to practice traditional airbrush techniques, you probably have an airbrush effects option in the graphics software of your computer. Understanding the principles of traditional airbrush rendering will help you maximize computer-generated airbrush options. For further study of airbrush art, review the work of contemporary super-realist Audrey Flack or the forties pin-ups of Vargas.

Airbrushes

Airbrushes are precision tools that combine liquids such as paints, inks, and water with compressed air to create a fine mist or spray. The spray from the airbrush applies paint in soft tonal gradations ranging from the highest discernable tint of color to complete opacity. All airbrushes have a color cup or bottle to hold pigment, an inlet for compressed air, a nozzle through which paint is sprayed under pressure, and a release valve (finger lever) that enables the operator to use air to propel the paint and to control the amount of air and paint that comes out of the nozzle. The three basic types of airbrush are the single-action, the double-action, and the oscillating airbrush. The main differences in airbrushes are their sensitivity and control.

Figure 6-1 shows the parts of an airbrush.

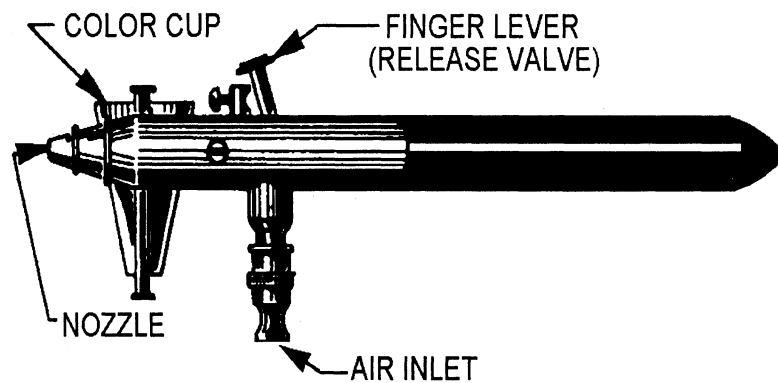

DMV30306

Figure 6-1.—Airbrush nomenclature.

Continued on next page

Airbrushes, Continued

Single-action airbrushes

The single-action airbrush, sometimes known as a poster brush, is simple in design. With single-action airbrushes, downward pressure on the finger lever releases the flow of air and paint. Some models of single-action airbrushes allow adjustment of the nozzle to regulate the amount of fluid flow. You may also adjust the finger lever to regulate the amount of air passing through the airbrush. These airbrushes work well for simple illustrations and large backgrounds. Single-action airbrushes may use heavy-bodied pigments such as tempura or casein.

Figure 6-2 is an example of a single-action airbrush.

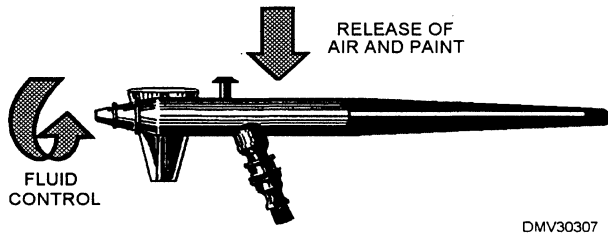

Figure 6-2.—Adjustments on a single-action airbrush.

Adjust the spray pattern of single-action airbrushes before use. After adjustment, only increasing and decreasing the distance between the airbrush and the paper surface will vary the spray pattern.

To adjust single-action airbrushes:

| Step | Action |
|------|--|
| 1 | Turn off the fluid control at the nozzle. |
| 2 | Hold the airbrush ½ inch in front of a scrap of paper. |
| 3 | Depress the finger lever and slowly open the nozzle (fluid control) until a wisp of color appears. |
| 4 | To make the spray pattern wider, continue to open the fluid control. |

Continued on next page

Airbrushes, Continued

Double-action airbrushes

Double-action airbrushes allow control and variation of the spray pattern during each stroke. Two separate finger actions control the spray pattern of double-action airbrushes. The first action is to depress the finger lever releasing air only. The second action is to pull the finger lever back releasing pigment. Pulling the lever further back releases more pigment and enlarges the spray pattern. Increasing or decreasing the distance between the airbrush and the paper surface will also vary spray pattern. The double-action airbrush, sometimes called a pencil brush, is a good general-purpose brush.

Figure 6-3 shows the parts of a double-action airbrush.

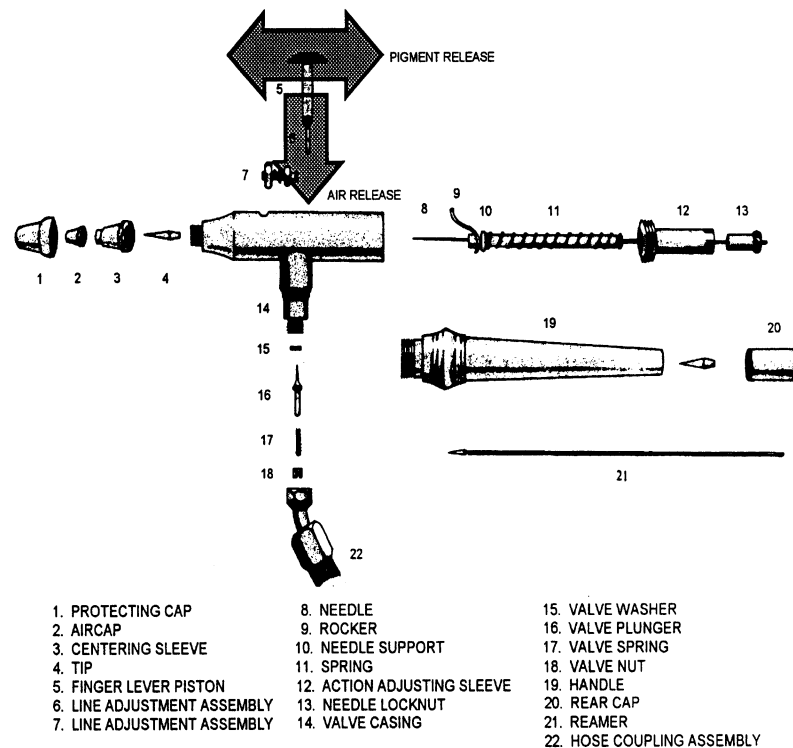

DMV30308

Figure 6-3.—Parts of a double-action airbrush.

Continued on next page

Airbrushes, Continued

Double-action
airbrushes
(Continued)

Figure 6-4 illustrates different spray patterns.

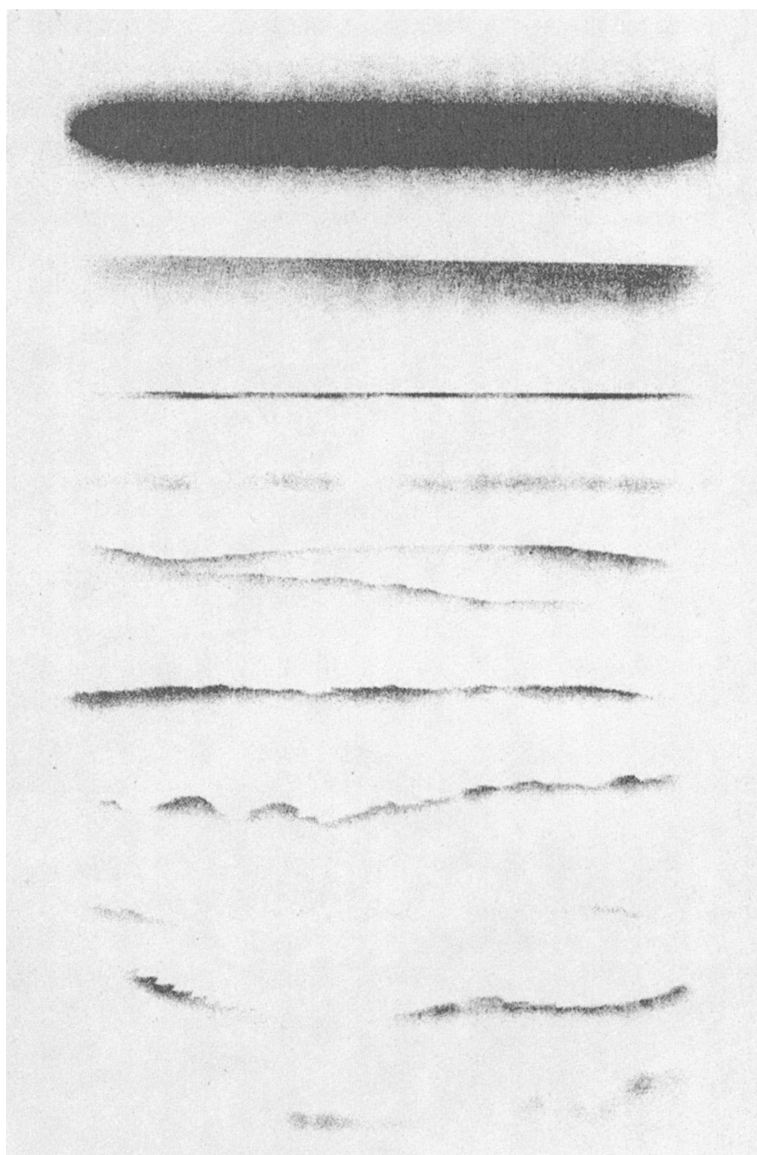

Figure 6-4.—Varying the spray pattern.

Continued on next page

Airbrushes, Continued

Double-action airbrushes (Continued)

Adjust the spray of double-action airbrushes before use. After adjustment, control the spray pattern by how far back you pull the finger lever (pigment flow) or increasing or decreasing the distance between the airbrush and paper. Setting the adjustment screw, located on the side of the airbrush near the finger lever, makes the flow of pigment constant. The double-action airbrush then works like a single-action airbrush and only requires the depression of the finger lever to release air.

To adjust the spray pattern of double-action airbrushes:

| Step | Action |
|------|--|
| 1 | Turn off fluid control at the nozzle. |
| 2 | Hold the airbrush ½ inch in front of a scrap of paper. |
| 3 | Depress the finger lever and slowly open the nozzle (fluid control) until a wisp of color appears. |
| 4 | To make the spray pattern wider, continue to open the nozzle. |

Using a double-action airbrush

Three distinct motions control and coordinate the use of double-action airbrushes. During these three actions, keep your hand and arm in motion until the end of a stroke. At the end of a stroke, allow the finger lever to move forward to stop paint flow, then, release the lever to stop the air. Each action must follow the others closely. The entire movement should be slow, smooth, and steady. Move the whole arm across the paper from the shoulder, not the wrist. Do not dip your hand, turn your wrist, or change the angle of the brush. Begin working about 8 inches above and at a 90° angle to the paper surface.

Continued on next page

Airbrushes, Continued

Using a double-action airbrush (Continued)

To use double-action airbrushes:

| Step | Action |
|------|---|
| 1 | Adjust the airbrush. |
| 2 | Position yourself comfortably with the airbrush in your hand and the hose out of the way. |
| 3 | Set the hand in motion. |
| 4 | Press the finger lever down, releasing air not paint. |
| 5 | Gently pull the finger lever back to release paint. Running all three actions together results in a sudden burst of paint at the beginning of a stroke. |

Figure 6-5 illustrates how to hold a double-action airbrush above the paper surface.

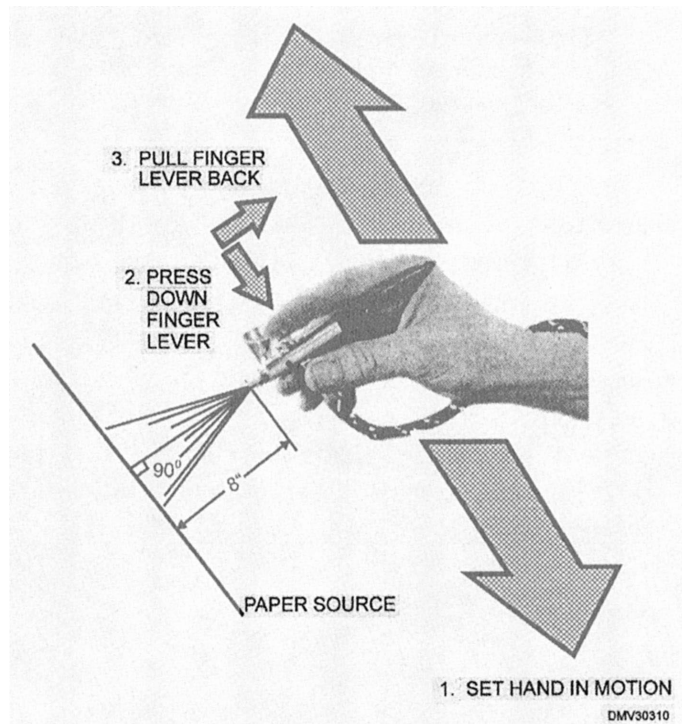

Figure 6-5.—Holding and moving the airbrush.

Continued on next page

Airbrushes, Continued

Oscillating airbrushes

Oscillating airbrushes are small airbrushes with a reciprocating needle that allows precise applications and minute spray patterns. The slow action of the needle provides better spray control. The fine spray pattern eliminates the need for masking massive areas of the illustration to prevent unwanted coloration. You may rest the bottom of the color cup on the illustration to increase stability and facilitate accuracy. The oscillating airbrush is the ideal tool for portraits, still lifes, landscapes, and photographic retouching. You can also use oscillating airbrushes in freehand work. Operation of the oscillating airbrush is similar to that of the double-action airbrush.

Holding an airbrush

Hold an airbrush with your thumb, middle, ring, and little fingers on the air inlet. Position the index finger above and lightly on top of the finger lever. Wrap the air hose below the thumb, over the wrist (toward the inside of your body) and under the elbow to keep the hose behind you and out of the way. Move the whole arm across the paper from the shoulder, not the wrist, in a slow, smooth, steady stroke. Do not dip your hand, turn your wrist, or change the angle of the brush. Begin the release of air and pigment before reaching the edge of the paper surface. Stop the flow of air and pigment after passing the opposite edge of the paper. Work approximately 8 inches above and at a 90° angle to the paper surface.

Left-handed airbrushes

Airbrushes are available that have the color cup or bottle on the left side of the airbrush. These airbrushes allow the left-handed artist to paint less awkwardly and with less fatigue. If you are left handed, place the holder for the airbrush on your left to prevent draping the air hose across your lap while you paint.

Pressure-fed airbrushes

Pressure-fed airbrushes have nine, 2-ounce color bottles in a pressurized canister. The canister connects to a multiple hose and selection valve that allow selection of one of the nine bottles or a mixture of any two adjacent colors. Pressure-fed airbrushes are intended for professional use in a production environment.

Continued on next page

Airbrushes, Continued

Gravity-fed airbrushes

Gravity-fed airbrushes have the color cup positioned on top of the airbrush or over the nozzle. The color cup is out of the way of your hand and does not obstruct your view of the illustration. Gravity-fed airbrushes may use thicker pigments. Less air pressure is required to disburse paint and the airbrush clogs less often.

Figure 6-6 is an example of a gravity-fed airbrush.

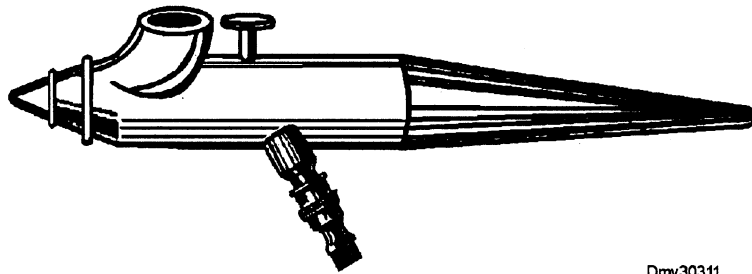

Figure 6-6.—A gravity-fed airbrush.

Siphon-fed airbrushes

Siphon-fed airbrushes have side-mounted color cups or bottles and use air passing through the airbrush to suck paint from the base of the color cup. This is the most common type of airbrush system. Changing colors is as easy as removing one color cup and replacing it with a color cup filled with another color. The size of color cups or bottles varies.

Figure 6-7 is an example of a siphon-fed airbrush.

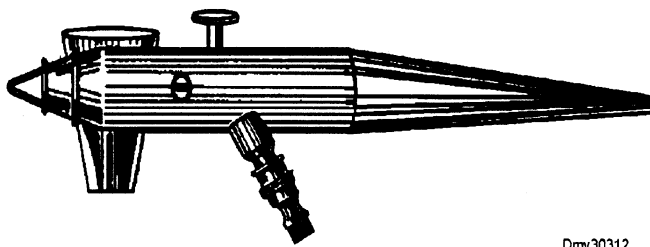

Figure 6-7.—A siphon-fed airbrush.

Component Parts

Introduction

The component parts of an airbrush system include an air source, air hoses, moisture traps, and regulators.

Air sources

Any nonflammable air source capable of generating enough pounds per square inch (PSI) pressure to propel pigment in air is suitable for airbrush use. **DO NOT USE FLAMMABLE GASES SUCH AS OXYGEN.** Air supplies may include pressurized aerosol cans, cylinders of inert gas, inner tubes, or air compressors with or without air storage tanks. Compressors without tanks operate continuously. Compressors with tanks operate until air builds to a specified pressure, then shuts off. If air pressure drops, the motor on the compressor turns on. Air compressors are the preferred source of air supply because the air pressure is continual and can be regulated and stored. Air compressors may be located away from the airbrush artist to maintain a quiet work environment.

Figure 6-8 shows an air compressor with a storage tank.

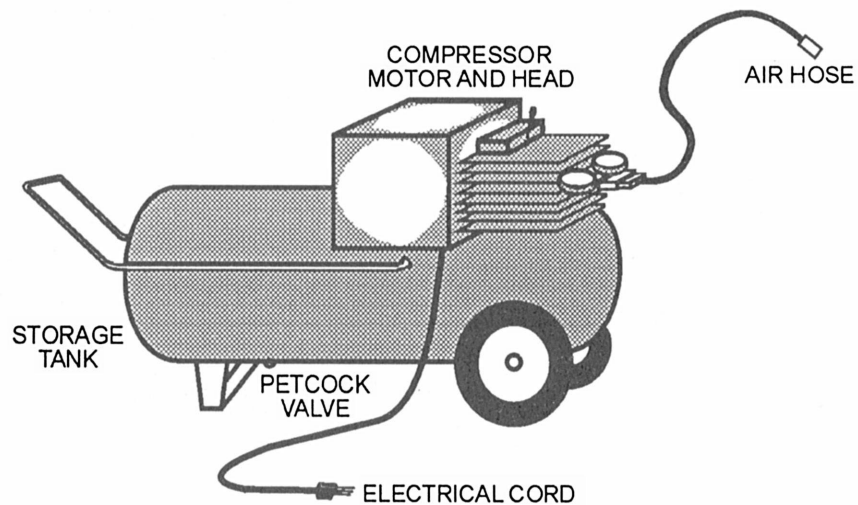

DMV30313

Figure 6-8.—An air compressor with a storage tank.

Continued on next page

Component Parts, Continued

Air hoses

Connecting the air source to an airbrush is a flexible air hose. Air hoses are available in different lengths. Some air hoses are permanently curled to eliminate the hazards of someone crimping or stepping on hoses. A multiple hose for a pressure-fed air painting system allows pigment to be removed from two color bottles simultaneously. The ends of air hoses are capped with brass screw fittings that attach to the air inlet of the airbrush and the air outlet of the air compressor. Inspect the condition of air hoses for cracks and wear. Replace worn or weak air hoses before they burst under pressure causing injuries.

Figure 6-9 shows common end cap fittings for standard air hoses.

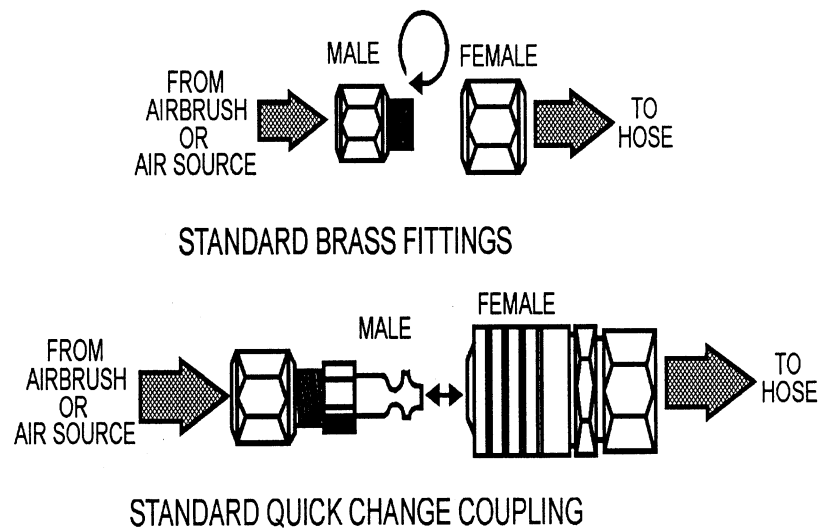

DMV30314

Figure 6-9.—Common fittings.

Continued on next page

Component Parts, Continued

Regulators

Regulators control the amount of air the air supply provides to the airbrush. They do not control how much air the air source produces. Regulators, located on air compressors or cylinders, are adjustable and may vary air pressure creating special effects or compensating for pigment viscosity. An ideal working air pressure for an airbrush is 25 to 30 PSI. Once the compressor reaches the desired air pressure, excess air is released by a valve (on air compressors without tanks) or diverted into a storage tank. Unregulated air supplies provide uneven air flow that is sometimes more or less than the ideal PSI for airbrush use. Lowering air pressure produces stipple or granulated effects. Fluctuating pressure produces splattered spray patterns. The greater the increase or decrease in pressure, the more pronounced the effect on the spray pattern. Most regulators have a brass screw fitting that attaches to the top of the air outlet of an air compressor or cylinder of gas.

Figure 6-10 shows how the dial of a regulator may appear.

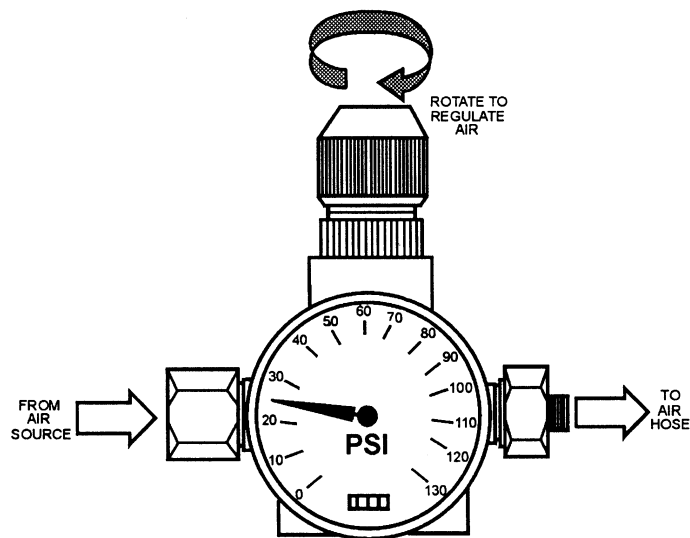

Figure 6-10.—A regulator dial.

Continued on next page

Component Parts, Continued

Moisture traps Moisture traps filter moisture from the air provided by the air source before the air reaches the airbrush. Although not having a moisture trap does not prevent you from using an airbrush system, they are invaluable in areas of high humidity and prevent your art from receiving water droplets with the pigment. Install moisture traps on air hoses between the airbrush and air source. The air hose may have to be severed and recapped with fittings contained on each end of the moisture trap. Periodically inspect moisture traps for rust or debris.

Figure 6-11 illustrates the position of the moisture trap.

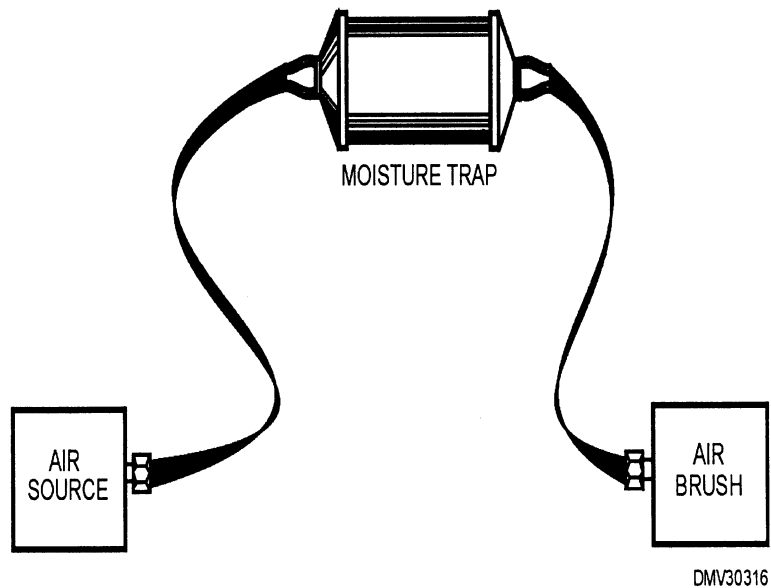

Figure 6-11.—The positioning of the moisture trap.

Maintenance

Introduction Maintaining an airbrush system in peak condition is the key to trouble-free operations in the field. Always refer to the manufacturer's instruction book for maintenance procedures for the airbrush and air compressor.

Cleanliness Keep your equipment and work area clean. Small bits of debris are magnified by sprayed pigment and may ruin illustrations.

Cleaning airbrushes Most airbrush system breakdowns occur when paint clogs air passages. Thoroughly clean airbrushes immediately after use. If you are air painting and spraying is interrupted for any length of time, flush pigment from the airbrush and color cup or bottle. A small amount of petroleum jelly, NOT OIL, on the threads of the nozzle will help prevent pigment encrustation.

To flush color from the airbrush and color cup:

| Step | Action |
|------|--|
| 1 | Dump out remaining paint and rinse color cup with appropriate solvent. Use a small bristle brush to loosen any dry or encrusted pigment. |
| 2 | Open the nozzle to allow air and solvent to flow freely. |
| 3 | Add clean solvent to the color cup and blow solvent through the airbrush. |
| 4 | Repeat step 3 until the solvent comes out of the nozzle clear. |
| 5 | Remove the color cup and blow only air through the airbrush to remove remaining solvent and dry internal parts. |

Continued on next page

Maintenance, Continued

Cleaning airbrushes (Continued)

Cleaning an airbrush with a bottle is slightly different from cleaning an airbrush with a color cup.

To flush color from the airbrush and bottle:

| Step | Action |
|------|--|
| 1 | Hold a sponge tightly against the nozzle of the airbrush. |
| 2 | Depress the finger lever. This will blow color back into the bottle. |
| 3 | Remove the bottle of paint and attach a bottle of solvent. |
| 4 | Blow solvent through the airbrush into the sponge until the solvent comes out clear. |
| 5 | Remove the bottle and blow only air through the airbrush to remove any remaining solvent and dry internal parts. |
| 6 | Clean the bottle thoroughly, removing dry or encrusted pigment with a small bristle brush. |

Airbrushes do not require disassembly for cleaning, but you should occasionally check the airbrush internally to see if the needle is properly seated. Always protect the needlepoint. Damage, no matter how slight, will cause the airbrush to malfunction. Replace damaged needles.

To check the position of the needlepoint:

| Step | Action |
|------|---|
| 1 | Unscrew the handle (figure 6-12). |
| 2 | Loosen the needle locknut by turning it counterclockwise (figure 6-13). |
| 3 | Remove the needle gently from the airbrush nozzle (figure 6-14). |

Continued on next page

Maintenance, Continued

Cleaning airbrushes (Continued)

Figure 6-12 shows how to expose the needlepoint.

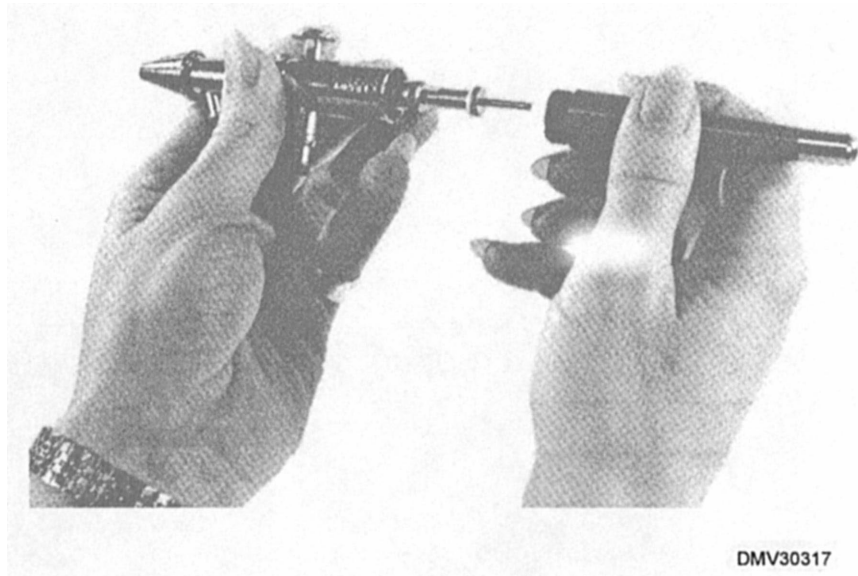

Figure 6-12.—Exposing the needlepoint.

Figure 6-13 illustrates the loosening of the needle locknut.

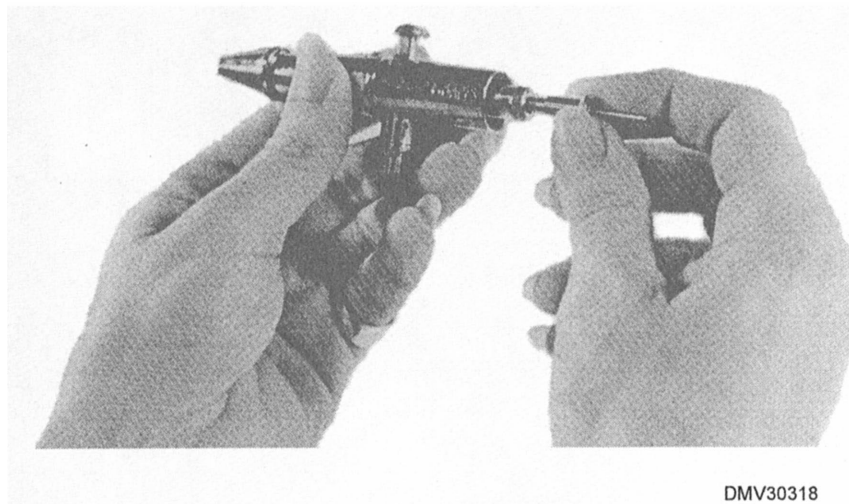

Figure 6-13.—Loosening the needle locknut.

Continued on next page

Maintenance, Continued

Cleaning airbrushes (Continued)

Figure 6-14 shows the needlepoint removed from the airbrush.

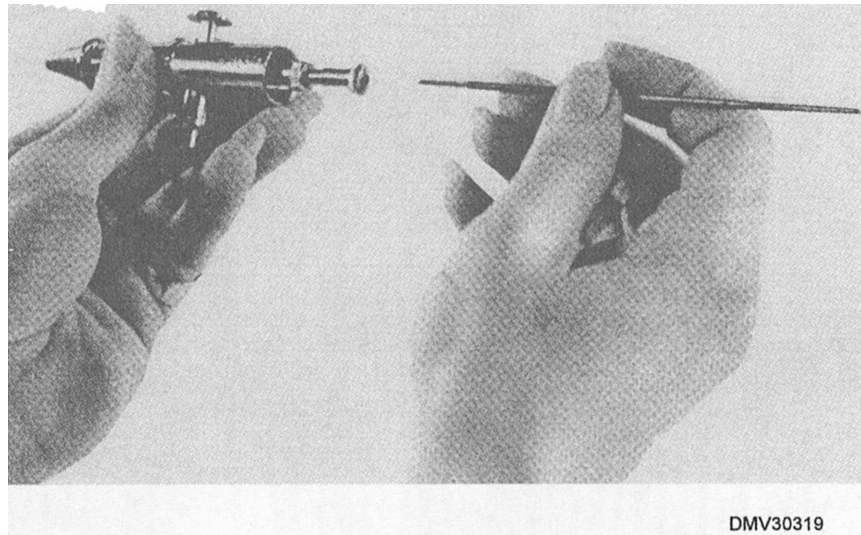

Figure 6-14.—Removing the needlepoint from the airbrush.

To reinsert the needlepoint:

| Step | Action |
|------|---|
| 1 | Push the finger lever forward. |
| 2 | Carefully push needle forward until it seats in the nozzle tip. |
| 3 | Replace the locknut turning it clockwise. Make sure the needlepoint is secure. Do not over tighten. |
| 4 | Replace handle of airbrush. |

Continued on next page

Maintenance, Continued

Cleaning airbrushes

Occasionally during operation, you may experience some equipment malfunctions. The following table lists typical problems, causes, and remedies.

| Problems | Causes | Remedies |
|--|---|---|
| Airbrush spits moisture | Very moist or humid working conditions Moisture in air passages | Install a moisture trap between the air source and airbrush |
| Airbrush fails to spray | Clogged fluid control Fluid too thick Insufficient air pressure | Clean or disassemble airbrush and soak in solvent Thin fluid with appropriate solvent Increase air pressure |
| Airbrush sprays in intermittent spurts | Air leaks in hose connections Clogged airhole in lid of paint bottle | Inspect and tighten connections Clean airhole |

Compressor maintenance

Air compressors are normally maintenance free. However, air compressors with storage tanks do require draining the storage tank of air. Failure to drain the air from the storage tank causes rust in the tank from condensate build-up. Rust weakens the tank walls causing a rupture under pressure. Drain the air from the air compressor storage tank by turning the petcock valve located on the underside of the tank to the full open position. You will hear the rush of air. When the hissing subsides, the tank is empty. Close the petcock before using the compressor again.

Airbrush Pigments

Introduction Not all paints are suitable for airbrush application. Knowing what paints your airbrush can handle will extend the useful life of the equipment. Refer to the manufacturer's instructions for the type of pigments your airbrush is designed to use.

Pigments Pigments for the airbrush are liquids such as watercolors, retouch greys, inks, dyes, and oil colors. Pigments must be finely ground, thoroughly mixed, and free of lumps or impurities. Make it a practice to routinely strain pigments through a nylon stocking or fine mesh screen before using. Normally, standard airbrushes cannot handle lacquers or enamels. There are special airbrushes for lacquers or enamels that can withstand the deleterious effects of caustic solvents.

Pigment viscosity Pigment viscosity refers to how thick or thin the mixture of pigment and solvent or vehicle in the color cup is mixed. If paint is too thick, it will not atomize and spray from the nozzle; therefore, add thinners to the paint. If paint is too thin, it will not cover properly and will run very quickly. Overly thinned paint may also dry too rapidly. Judging paint correctly requires practice and patience.

Solvents for pigments Solvents thin or dilute the consistency of pigment. Water-based paints, inks, dyes, and retouch greys require water for thinning or clean-up. Oil-based pigments require solvents for dilution or clean-up. Make sure you match the pigment to the solvent or the pigment will curdle and may permanently ruin the airbrush.

Mixing pigments When preparing pigments for airbrushing, mix enough pigment to cover an entire area. If the paint is a custom-mixed color, the likelihood of preparing a second-batch, exact match is slim. Also, stopping in the middle of an air painting session is an inconvenient time to stop to remix color.

Pigment stain Colors with chemically composed pigmentation have strong residual colors that may stain other colors. Pigment dried or encrusted in the color cup or bottle may redissolve when saturated with another color of the same solvent base and bleed into the other color.

Preparing To Airbrush

Introduction

Proper preparation before sitting down to airbrush saves many hours of frustration. Gather the materials you need to airbrush. Have the assorted equipment and consumables readily available and arrange time when you will have the least interruptions.

Thumbnails

Thumbnail sketches are small images of how you expect the finished art to look. Prepare preliminary thumbnail sketches to determine layout. Select an appropriate layout and create a comprehensive thumbnail sketch indicating the areas of light, dark, and color. Use a thumbnail sketch as you would a map, veering only slightly and when necessary. Do NOT attempt to make decisions on shading and color as you air paint because corrections are almost impossible once you begin spraying.

Painting surfaces

Select a paper or substrate on which to paint. Substrates include masonite, metal, canvas, or fabric. Mount paper or substrates to a solid surface if you feel the moisture of painting will warp the surface. The paper or substrate must be free of fingerprints, cuts, holes, glue, paints, or other imperfections. Any texture on the paper or substrate will show. Spraying on a textured surface at an angle other than 90° magnifies texture. For example, crumpling paper, then spraying at a low angle creates an affect resembling mountain ranges.

Figure 6-15 illustrates how crumpling paper and spraying at a low angle resembles mountain ranges.



Figure 6-15.—Crumpled paper sprayed at an angle less than 90 degrees resembles mountain ranges.

Continued on next page

Preparing to Airbrush, Continued

Masks

Masks are moveable patterns or patches, similar to templates and may be made of acetate or heavy weighted paper. Masks protect areas that are NOT to be painted. Cut a mask in any desired shape and place over the area of the drawing. Setting the mask directly on the drawing surface and spraying on it will create a hard-edged line. Raising the mask from the drawing surface allows paint overspray to seep under the edge of the mask softening the line.

Figure 6-16. shows a hard-edged line created by a mask.

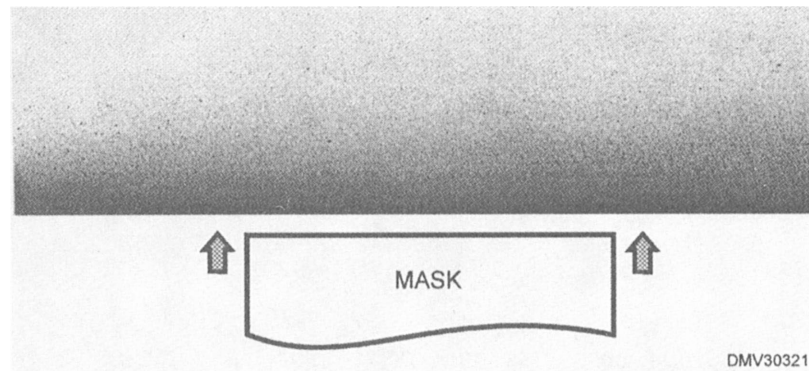

Figure 6-16.—A hard-edged line created by a mask.

Figure 6-17 shows a soft-edged line created by raising the edge of the mask off the drawing surface.

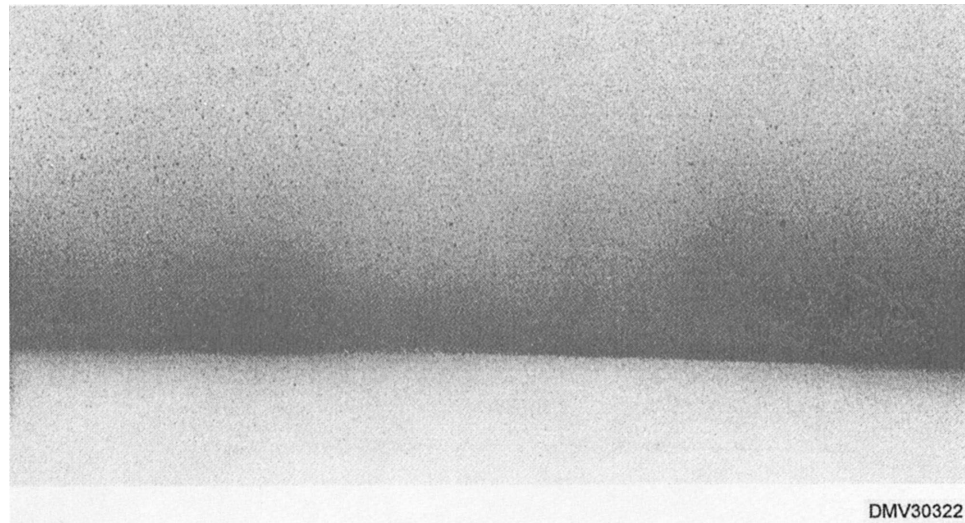

Figure 6-17.—A soft-edged line created by a raised mask.

Continued on next page

Preparing to Airbrush, Continued

Friskets

A frisket is a transparent or translucent adhesive-backed sheet used to protect areas of the drawing you do NOT want painted. Place a frisket over the drawing, gently cut and remove the areas of the frisket to be painted. Use a sharp blade and only enough pressure to cut through the frisket. Excessive pressure scores or scars the drawing, or worse yet, may slice all the way through the substrate. Apply pressure lightly to the frisket. No air bubbles should remain under the frisket. Make sure the edges of a frisket are firmly in place to prevent overspray from seeping under them. Remove friskets from painted surfaces carefully and remove excess adhesive with your finger or a rubber cement pick-up.

To apply friskets:

| Step | Action |
|------|--|
| 1 | Place the frisket over the drawing. |
| 2 | Carefully cut the frisket on the outline of the drawing. |
| 3 | Remove the frisket from the areas you wish to paint. |
| 4 | Apply light pressure to the frisket squeezing out all air bubbles. |
| 5 | Make sure all edges of the frisket are firmly adhered. |

To remove friskets:

| Step | Action |
|------|--|
| 1 | Allow the pigment to dry before removing frisket. |
| 2 | Carefully peel the frisket away from the drawing surface. |
| 3 | Discard the frisket or return the frisket to its backing sheet for storage if you must reuse the same frisket later. |
| 4 | Touch up any scratches or pick-off from the outline of the shape that was painted. |

Continued on next page

Preparing to Airbrush, Continued

Friskets (Continued)

Figure 6-18 shows a frisket on a wheel.

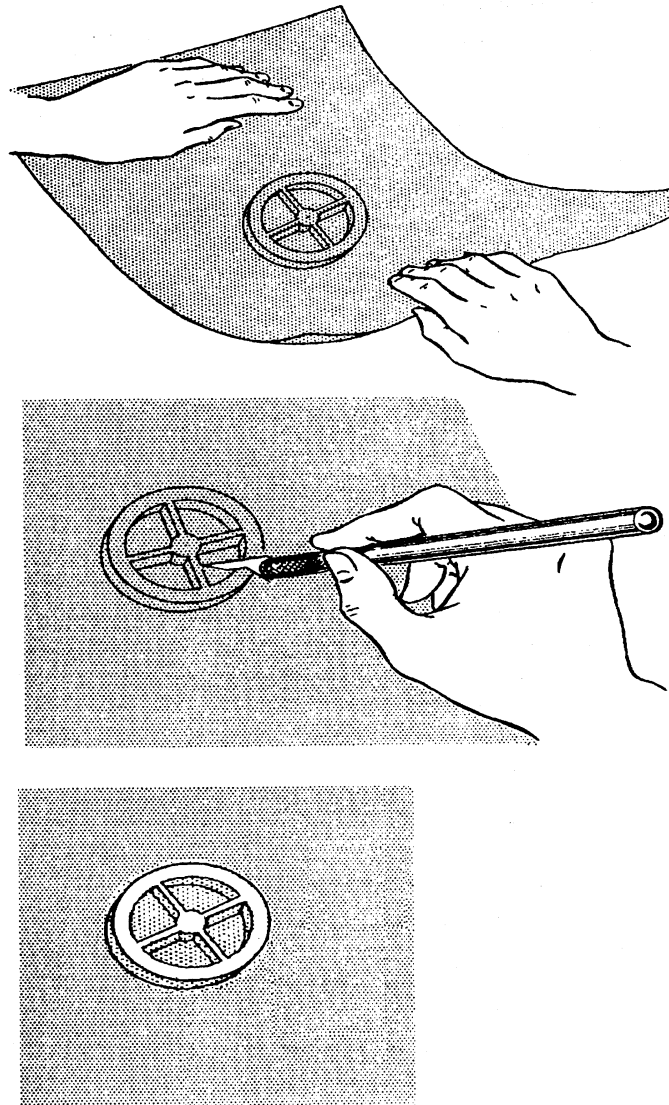

DMV30323

Figure 6-18.—Placing frisket over an illustration.

Continued on next page

Preparing to Airbrush, Continued

Steps in airbrushing

Steps in airbrushing follow a logical sequence. The following table lists a series of steps that will assist you in developing airbrush illustrations.

To airbrush illustrations:

| Step | Action |
|------|--|
| 1 | Prepare a comprehensive thumbnail sketch indicating desired color and shading. |
| 2 | Prepare a full sized illustration on a suitable substrate. |
| 3 | Cover areas you do NOT want painted with masks or friskets. |
| 4 | Mix pigments to proper consistency and strain out lumps or imperfections. Test the mixture on a piece of scrap paper. |
| 5 | Adjust your work center. Arrange your table so that you hold the airbrush at a 90° angle to the work surface and sit upright. |
| 6 | Place the airbrush in your hand and begin air painting. The painted areas should dry almost immediately. If paint runs, blow dry with airbrush held approximately 10 inches from the painting surface. |
| 6 | The first coverage of paint should be light. Build up tones gradually using successive layers of paint. |
| 8 | Allow the paint to dry. |
| 9 | Remove masks and friskets. |
| 10. | Remove residual adhesive from the friskets. |
| 11. | Touch up areas disturbed by the frisket. |
| 12. | Add small details by hand with brushes or other tools. |
| 13. | Add highlights. |

Even Tones

Introduction

Creating an even tone is a demanding task with the airbrush, particularly when air painting in transparent color. An even tone is less difficult to accomplish with an opaque medium. Practice rendering even tones on cheap drawing paper.

Even tones

Even tones have no modulation in color or visual texture. It is a solid blanket of color. Even tones applied gradually 'by successive layers appear to have more depth than heavily applied pigment.

To airbrush even tones:

| Step | Action |
|------|--|
| 1 | Prepare a simple paper mask. |
| 2 | Using masking tape, tape the mask to the paper surface allowing the tape to overlap onto the paper by 1/8 inch. |
| 3 | Press tape down firmly to avoid paint seepage. |
| 4 | Air paint across the top of the paper from left to right, allowing the spray to overlap the top of the tape. |
| 5 | Direct the return stroke from right to left and proceed down the paper until the last stroke overlaps the tape. All strokes should overlap slightly. |
| 6 | Keep the first coverage light, increasing darkness with successive strokes. |
| 7 | Allow both the paper and the mask to dry before carefully removing the mask. |

Continued on next page

Even Tones, Continued

Even tones
(Continued)

Figure 6-19 illustrates the procedure for airbrushing even tones.

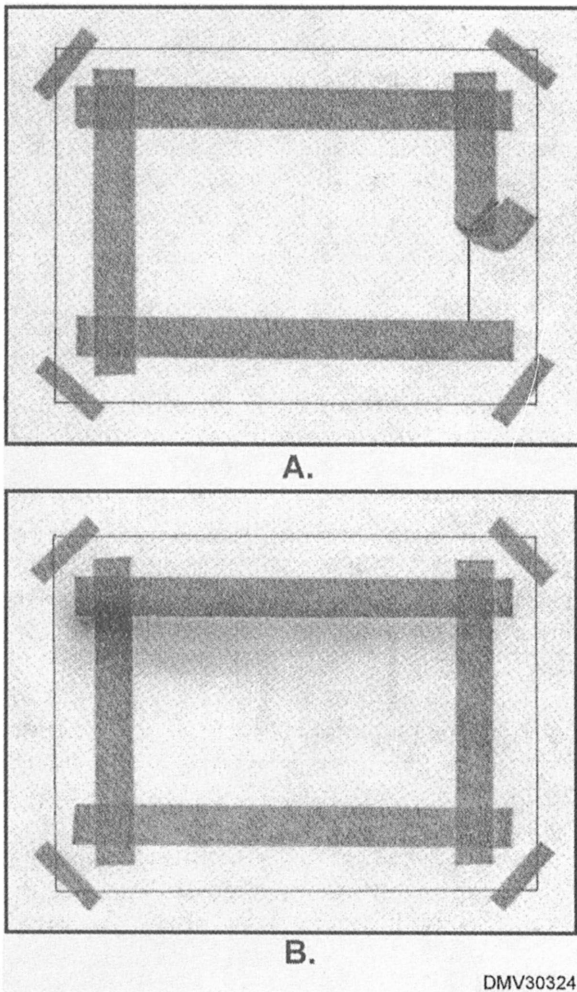

Figure 6-19.—Airbrushing even tones: A. Mask the borders; B. Spray from top down.

Graduated Tones

Introduction

Control of the airbrush is a matter of practice. After you learn to paint even tones, begin practicing the techniques for applying graduated tones.

Graduated tones

Graduated tones have colors that vary in density. The colors may go from light to dark, dark to light, or fluctuate back and forth. Air paint graduated tones working from dark to light.

To airbrush graduated tones:

| Step | Action |
|------|--|
| 1 | Prepare a simple paper mask. |
| 2 | Using masking tape, tape the mask to the paper surface allowing the tape to overlap onto the paper by 1/8 inch. |
| 3 | Working from left to right, begin airbrushing dark values at the top of the page working into light values at the bottom of the page. |
| 4 | Return stroke from right to left. Allow the paint to fade off completely before reaching the light areas at the bottom of the page. |
| | Continue to airbrush, starting this time from the bottom of the page. |
| | Proceed up the page stopping just short of the first pass. |
| | Continue to airbrush from the bottom of the page stopping short of each of the previous passes each time. Builds up values by repeated coverage. |

Continued on next page

Graduated Tones, Continued

Graduated
tones
(Continued)

Figure 6-20 shows a graduated tone.

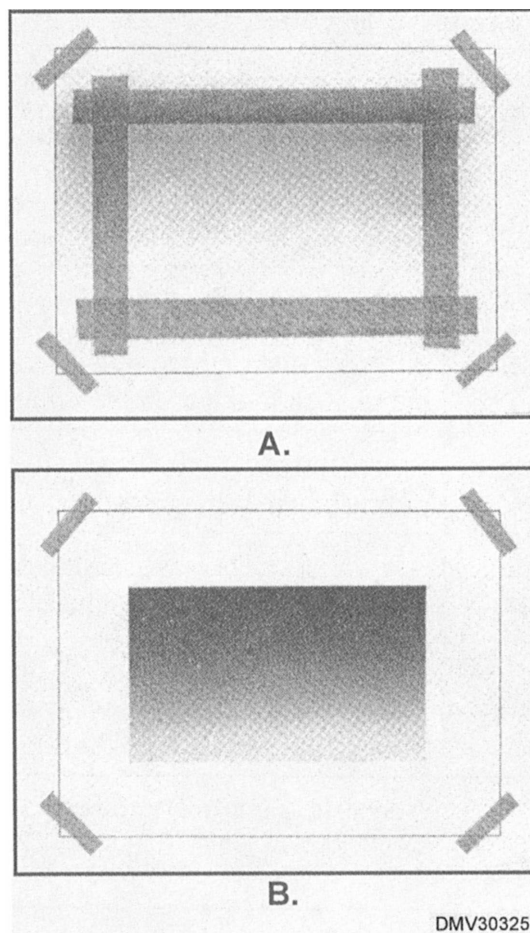

Figure 6-20.—Airbrushing graduated tones: A. Airbrush dark values at the top; B. Build up values.

Spot Effects

Introduction The spot effect is simple to produce and effectively adds depth to an illustration.

Spot effect The spot effect appears as a spot of light on a darker field. The most important thing to remember about creating a spot effect is to bend your wrist upward without moving your entire arm, raising the spray pattern slightly. This movement rounds the corners and forms the spot in the center.

To airbrush a spot effect:

| Step | Action |
|------|---|
| 1 | Cut a simple paper mask with a square opening. |
| 2 | Tape the edges of the mask to the paper surface. |
| 3 | Turn the paper counterclockwise so that one corner faces you. |
| 4 | Airbrush two or three passes across the corner. Most of the pigment should fall on the mask at this point. |
| 5 | Rotate the paper (counterclockwise), taking each corner in turn and airbrush two or three passes in each corner. |
| 6 | After all four corners are sprayed, air paint about ½ inch of each corner in color fading gradually into the highlight area. The transition should be smooth with the spot fairly light and about ½ inch of solid color at each corner. |
| 7 | Spray a light tone along the edge of the mask. |
| 8 | Allow the paint to dry thoroughly before removing the mask. |

Continued on next page

Spot Effects, Continued

Spot effects
(Continued)

Figure 6-21 illustrates how to airbrush a corner and the finished spot effect.

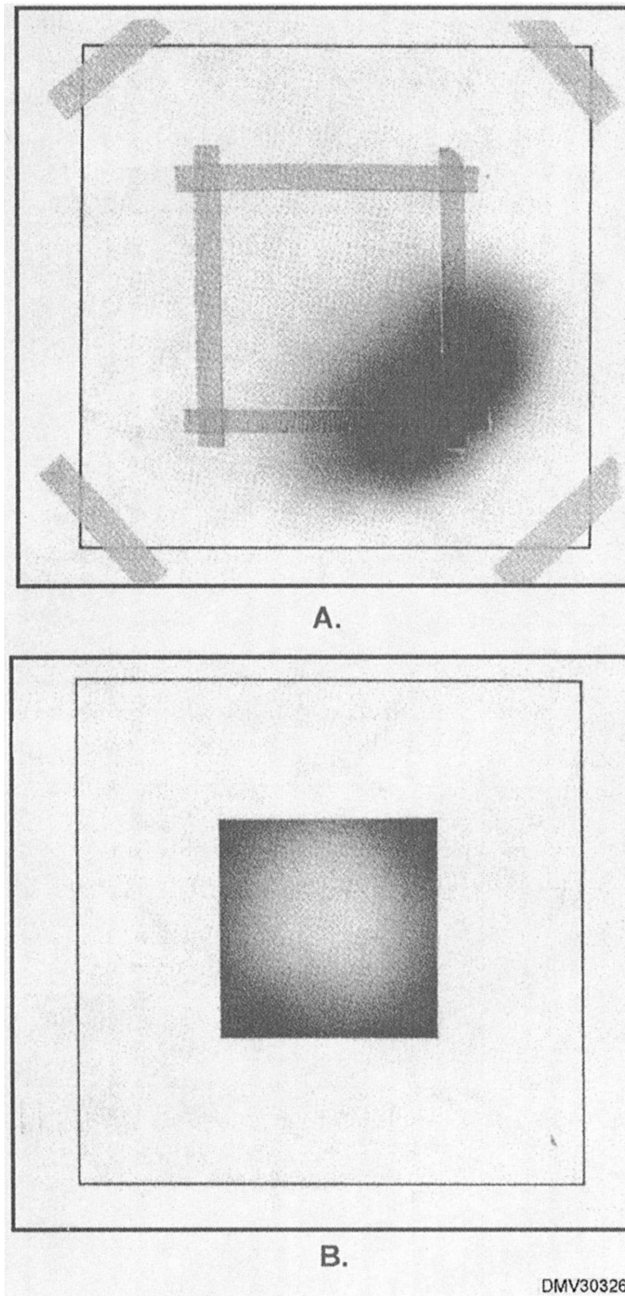

Figure 6-21.—Airbrushing: A. A corner of the spot effect; B. The spot effect.

Metallic Effects

Introduction

As your airbrush skills develop, you should attempt more difficult effects like a metallic shine. The harder an effect is to produce, the more essential it is to have a comprehensive sketch or layout to follow. With metallic effects, concentrate on defining the contrasts between dark and light tones on reflective surfaces. Airbrushed metallic effects come very close to visually portraying mirrors, glass, and chrome.

Metallic effects

Metallic effects are the shine or reflectance from metal objects struck by intense light. Shiny objects have little or no local color of their own but reflect the color of the objects that surround them. The sharp contrasts in dark and light tones are defined by hard-edged lines. Work from dark to light when creating metallic effects.

To airbrush metallic effects:

| Step | Action |
|------|--|
| 1 | Place a mask or frisket over your illustration. |
| 2 | Remove the frisket from the areas to be painted in the darkest tone (black in figure 6-22). Paint and allow to dry. |
| 3 | Remove the frisket from the areas to be painted in grey (figure 6-23). Paint and allow to dry. |
| 4 | Remove the remaining frisket and recover the illustration with a new sheet of frisket. |
| 5 | Cut along the outline of the object and remove the frisket covering the background. |
| 6 | Spray shadows freehand. Spraying in a shadow area creates depth and provides a three-dimensional impression (figure 6-24). |
| 7 | Lightly spray over the entire background. Allow to dry. |
| 8 | Remove the frisket (figure 6-25). |
| 9 | Clean and touch up illustrations with highlights. |

Continued on next page

Metallic Effects, Continued

Metallic effects (Continued) Figure 6-22 shows a drawing with the darkest tone (black) painted.



DMV30327

Figure 6-22.—A line outline with the darkest tone (black) painted.

Figure 6-23 shows the drawing with a lighter tone (diluted black) painted.



Dmv30328

Figure 6-23.—Illustration with a lighter tone (diluted black) added.

Continued on next page

Metallic Effects, Continued

**Metallic effects
(Continued)**

Figure 6-24 illustrates how shadows sprayed behind the object lend depth.



Figure 6-24.—Shadows sprayed behind the object lend depth.

Figure 6-25 is the finished illustration with the background evenly sprayed behind the object.



Figure 6-25.—The finished illustration with an evenly toned shadow area.

Special Effects

Introduction Any effect the airbrush produces may be used for special effects in the right situation. Selectively create special effects and use them to enhance your illustrations.

Special effects Special effects are effects created to enhance illustrations by emphasizing texture, color, or shapes. You may create special effects by varying air pressure, raising or moving masks, increasing or decreasing the distance between the airbrush and paper, and changing the angle of airbrush to paper surface.

Varying air pressure Reducing the air pressure from the air source to the airbrush will make the pigment heavier to transport in the air. This results in a granulated or stipple effect.

Figure 6-26 is an example of granulation resulting from reduced air pressure.

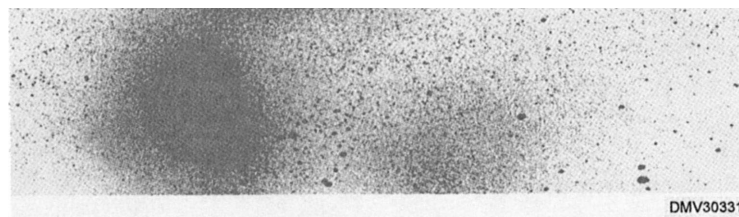

Figure 6-26.—Granulation resulting from air pressure less than 25-30 PSI.

Increasing air pressure from the air source to the airbrush provides more air than the pigment needs to reach its destination. The result is a random spatter with a fine mist of over spray.

Figure 6-27 is an example of splatter.



Figure 6-27.—Splatter created by air pressure in excess of 25-30 PSI.

Continued on next page

Special Effects, Continued

Raising, lowering, or moving masks

Raising, lowering, or moving masks will create different edge definitions. Creating a mask with a patterned edge will also create special effects. Raising a mask creates a soft edge. The higher a mask is raised, the softer the edge created. Raising the edge of masks permits the fine spray of paint to seep under the edge of the mask to the paper.

Figure 6-28 is an example of raised masks.

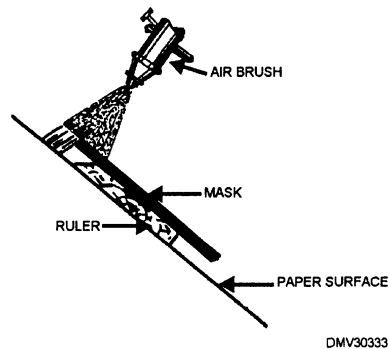

Figure 6-28.—A raised mask.

Lowering a mask creates a hard-edged line. Any weight or tape may hold a mask in place on a drawing.

Figure 6-29 is a line created by a mask placed directly on the paper surface.

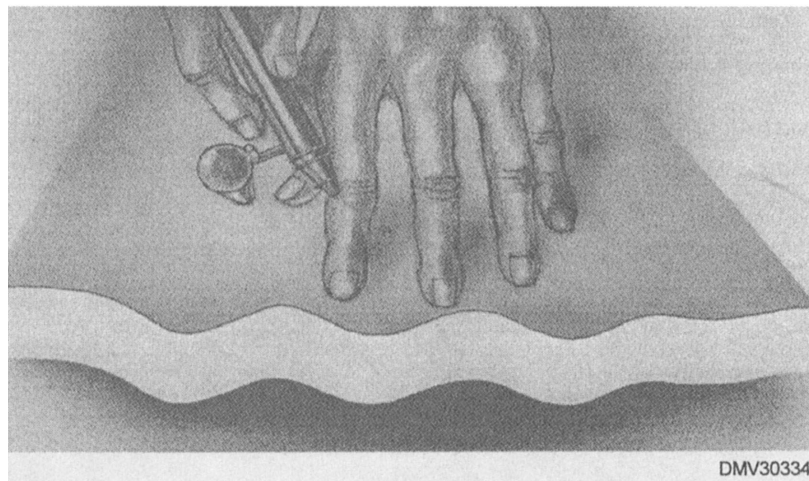

Figure 6-29.—Using a direct contact mask to create a hard edge.

Continued on next page

Special Effects, Continued

Raising, lowering, or moving masks (Continued)

Moving masks creates a layering effect that was popular in the thirties and forties. The pigment may be sprayed in the same color or in different colors.

Figure 6-30 shows a layering effect created by moving masks repeatedly around an illustration.



Figure 6-30.—Layering masks in an illustration.

Continued on next page

Special Effects, Continued

Increasing or decreasing distance between the airbrush and the paper surface

Increasing or decreasing the distance between the airbrush and the surface of the paper affects the width and wetness of the spray pattern. Increasing distance between the airbrush and the paper surface will increase the spray pattern. It will also apply a lighter tone, which dries faster creating a fine barely discernable wisp of color. Decreasing the distance between the airbrush and paper surface lessens the spray pattern applying a heavier, wetter layer of paint that the air from the brush further disburse in spidery lines. This effect is called the centipede effect.

Figure 6-31 illustrates the centipede effect resulting from the airbrush held closely to the paper surface.

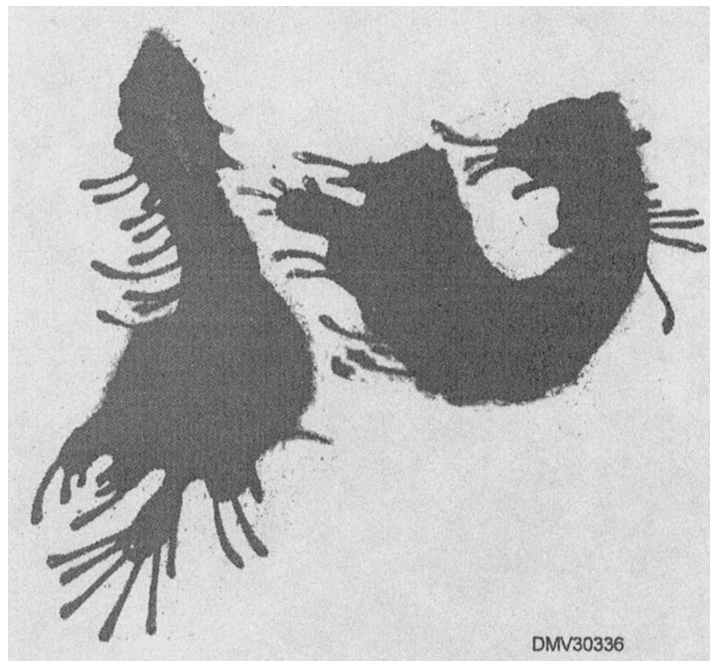

Figure 6-31.—The centipede effect.

Continued on next page

Special Effects, Continued

Changing the angle between airbrush and paper surface

Changing the angle between the airbrush and the paper surfaces can create an effect enhanced by any texture in the paper.

Figure 6-32 is examples of patterns sprayed at various angles over differently textured paper surfaces.

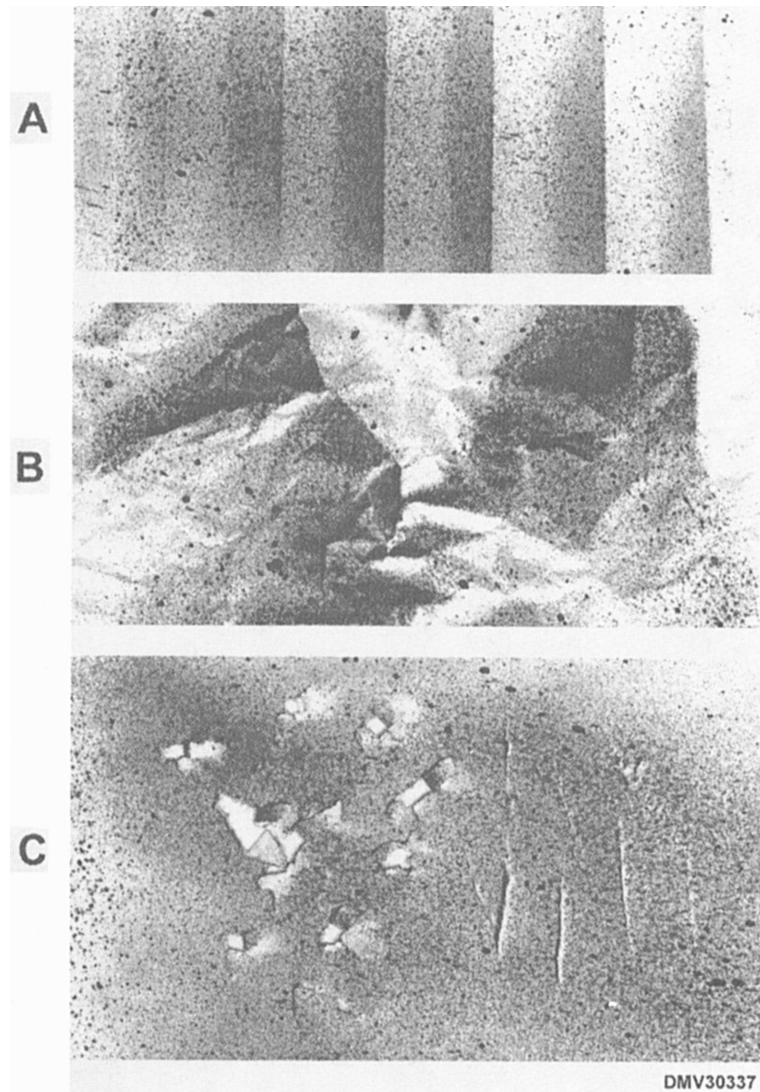

Figure 6-32.—Spray patterns on variously textured surfaces: A. Accordion folded; B. Crumpled paper; C. Torn paper.

Basic Shapes

Introduction

Airbrushing areas of light and shadow emphasizes the three-dimensional character of the four basic shapes; cubes, spheres, cylinders, and cones. Since everything you draw is a composite of the four basic shapes, understanding how light affects basic shapes helps your understanding how to airbrush light and shadow on other objects.

Cubes

Rendering basic cubes with an airbrush makes the three dimensions of height, width, and depth easier to see. When airbrushing cubes, start with the darkest plane first to serve as a value guide on which to base the other values. Starting with the darkest plane also saves masking certain areas when progressing to the lighter planes. Begin each plane in the darkest corner fading to the opposite corner. When finished, there should be as much contrast as possible between the intersections of the three planes.

To airbrush a basic cube:

| Step | Action |
|------|---|
| 1 | Draw a sharp, dark outline of a basic cube and place a frisket over it. Leave ample border all around. |
| 2 | Select which plane will be the darkest and remove the frisket from this area. |
| 3 | Turn the drawing so that the darkest corner is in front of you. This will make it appear as if your strokes diagonally cross the cube. |
| 4 | Apply pigment to this corner fading out as you progress to the corner directly opposite. Allow to dry. |
| 5 | Remove the frisket from the middle-toned plane. |
| 6 | Apply pigment to the darkest corner working diagonally across the block and fading the pigment out before reaching the opposite corner. Allow the pigment to dry. |
| 7 | Remove the frisket from the third plane. |

Continued on next page

Basic Shapes, Continued

Cubes
(Continued)

| Step | Action |
|------|--|
| 8 | Apply a lighter pigment than the first two tones. Do not apply paint to the far corner of the third plane letting it remain white. |
| 9 | Once dry, remove the remaining frisket from the cube illustration. |
| 10 | Clean up the illustration and apply any touch-ups or highlights by hand and brush. |

Figure 6-33 illustrates the steps in airbrushing a cube.

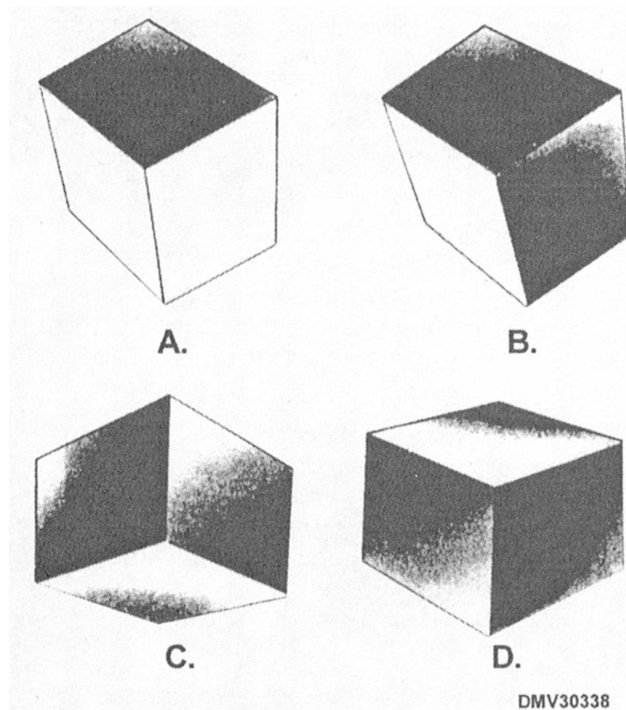

Figure 6-33.—The steps in airbrushing a cube.

Continued on next page

Basic Shapes, Continued

Spheres

Air painting spheres accents their roundness. Build up the tones on spheres gradually. Use short strokes in both directions as longer strokes on curved surfaces are hard to control. Curve your strokes to match the roundness of the sphere. When air painting spheres, progress from light to dark tones. Highlights on spheres should remain white.

To airbrush spheres:

| Step | Action |
|------|--|
| 1 | Draw a dark outline of a circle. Cover this drawing with frisket. |
| 2 | Remove the frisket from the circle. |
| 3 | Apply a light tone around the edge of the sphere allowing the spray to overlap the frisket. |
| 4 | Carry this tone up from the bottom of the sphere leaving the highlight as white as possible. |
| 5 | Apply a darker tone to the lower right side a short distance from the frisket. |
| 6 | Apply the same dark tone across the bottom and up the left side overlapping the frisket. |
| 7 | Apply a darker tone to the top of the sphere off the edge of the frisket and the lower right side. Continue to create a crescent of dark tone near the bottom of the sphere. |
| 8 | Once dry, remove the frisket. |
| 9 | Clean up the drawing and add touch-ups or details by hand with a brush. |

Continued on next page

Basic Shapes, Continued

Spheres (Continued)

Figure 6-34 illustrates the steps in airbrushing spheres.

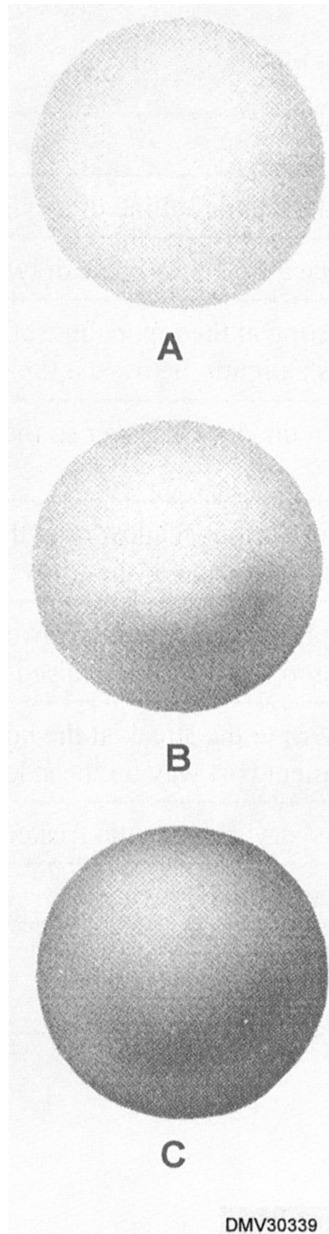

Figure 6-34.—The steps in airbrushing spheres.

Continued on next page

Basic Shapes, Continued

Cylinders

Cylinders reflect light at the bottom and top. The soft, graded edges make the flat rectangular shape have a definite round appearance. Using a raised mask on a cylinder body works better than using a frisket. When airbrushing cylinders, work from light to dark.

To airbrush cylinders:

| Step | Action |
|------|--|
| 1 | Make a dark outline of a cylindrical (rectangle) form. |
| 2 | Place a frisket over the drawing and cut out the area to be painted. |
| 3 | Starting at the top, paint a slight shadow over the raised edge of the mask slightly below the top of the cylinder. |
| 4 | Turn the drawing over so that the bottom of the cylinder is now the top. |
| 5 | Paint a slight shadow over the raised edge of the mask and slightly below the edge of the frisket. |
| 6 | Apply pigment slightly lower, leaving a light streak between it and the top stroke using a raised mask. Turn the drawing over again. |
| 7 | Return to the streak at the bottom of the cylinder and extend the pigment part way up the side. |
| 8 | Once dry, remove the frisket. |
| 9 | Clean up the drawing. |

Continued on next page

Basic Shapes, Continued

Cylinders
(Continued)

Figure 6-35 is an airbrushed cylinder.

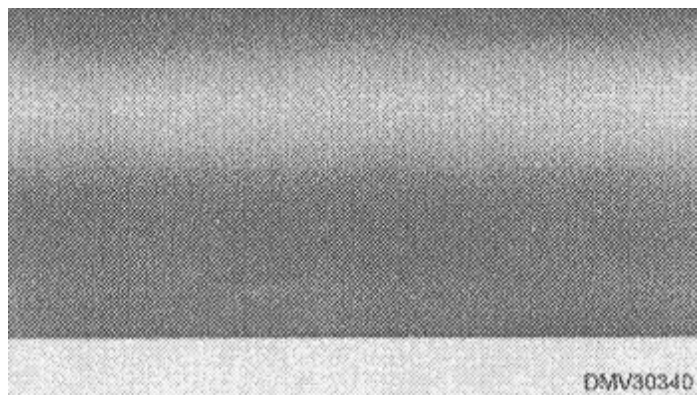

Figure 6-35.—The airbrushed cylinder.

Continued on next page

Basic Shapes, Continued

Cones

Cones are less easy to airbrush for they require some judgment in the shape of irregular forms. When airbrushing cones, work from light to dark.

To airbrush cones:

| Step | Action |
|------|---|
| 1 | Draw a dark outline of a cone. |
| 2 | Place a frisket over the drawing and remove the area to be painted. |
| 3 | Apply a light tone to the left and right side of the cone extending slightly along the base. |
| 4 | Using the same tone. Paint triangular shapes on each side of the cone from the apex to the base slightly in from the frisket. A raised mask will soften the edges of the paint. |
| 5 | Apply a darker tone on each side overlapping the frisket. |
| 6 | Use a raised mask and apply a dark tone to the center of the light-toned triangular shapes. |
| 7 | Once dry, remove the frisket. |
| 8 | Clean up the drawing, touch up by hand with a paint brush. |

Figure 6-36 illustrates the steps in airbrushing cones.

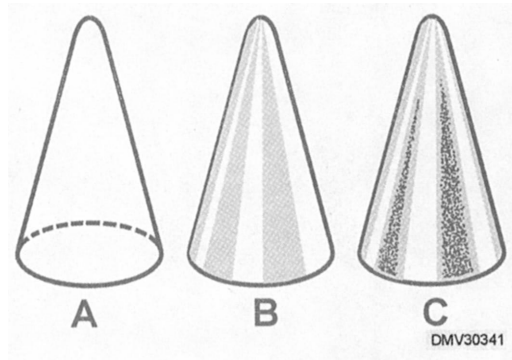

Figure 6-36.—Steps in airbrushing cones.

Pictorial Rendering

Introduction

Rendering illustrations with an airbrush produces very fine tonal gradations resembling photography. There is a definite procedure or sequence of actions to follow to successfully render imagery in airbrush.

Pictorial rendering

Pictorial rendering with an airbrush requires advance planning and meticulous preparation. Generally, you air paint light tones first, working toward the darkest. Work the illustration starting in the background, then the middle ground, and finally, the foreground. Details and highlights almost always require the use of a hand brush.

To airbrush pictures:

| Step | Action |
|------|--|
| 1 | Work out shading and detail on a comprehensive thumbnail sketch. |
| 2 | Draw out the image on illustration board. You may draw the image on paper and transfer it to illustration board by covering the back side with graphite and tracing it to the board (figure 6-37). |
| 3 | Place a frisket over the drawing and expose the background area. |
| 4 | Apply tone starting with the lightest area and progressing to the darker tones (figure 6-38). |
| 5 | Use a hand brush to add details. Allow to dry. |
| 6 | Cut away the frisket over the middle ground. |
| 7 | Cover the background with a partial frisket. |
| 8 | Apply paint to the middle ground starting with the lightest tones and progressing to the darker tones (figure 6-39). |
| 9 | 1 Use a hand brush to add details and allow to dry thoroughly. |

Continued on next page

Pictorial Rendering, Continued

Pictorial rendering (Continued)

| Step | Action |
|------|---|
| 10 | Remove the frisket from the foreground (figure 6-40). |
| 11 | Place a partial frisket over the middle and background. |
| 12 | Apply the lightest tones, then darker ones. |
| 13 | Use a hand brush to add details. Allow to dry. |
| 14 | Remove all friskets. |
| 15 | Emphasize highlights with a hand brush. |
| 16 | Clean up the illustration (figure 6-41). |

Figure 6-37 shows a drawing on illustration board ready to airbrush.

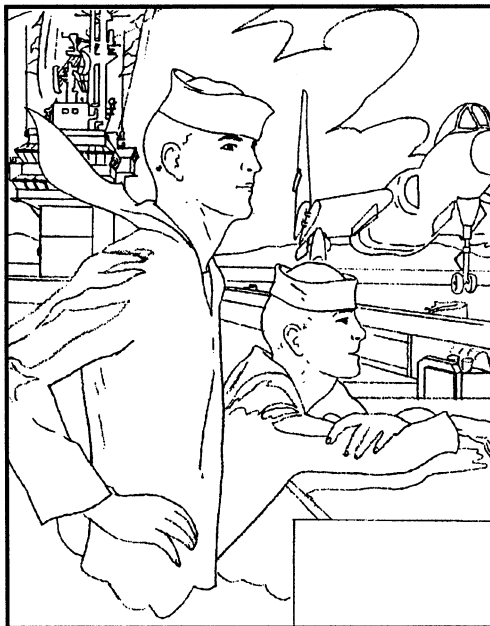

Dmw30342

Figure 6-37.—The basic drawing on an illustration board.

Continued on next page

Pictorial Rendering, Continued

**Pictorial rendering
(Continued)**

Figure 6-38 shows the illustration with the background airbrushed.

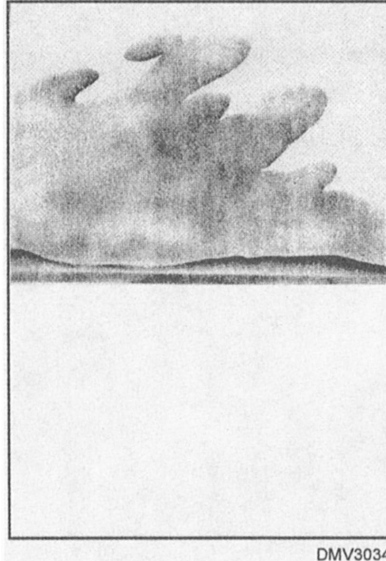

DMV30343

Figure 6-38.—The airbrushed background.

Figure 6-39 show the middle ground airbrushed.

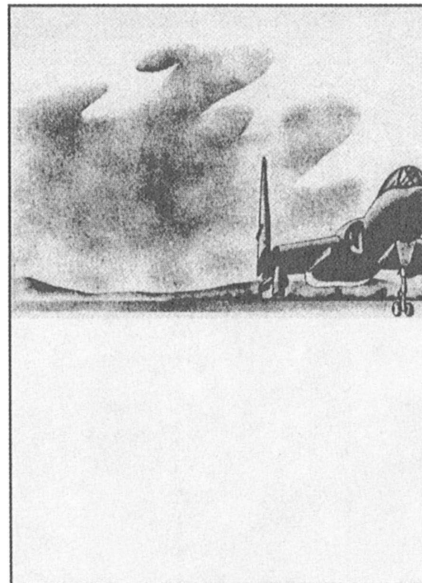

DMV30344

Figure 6-39.—The middle ground airbrushed.

Continued on next page

Pictorial Rendering, Continued

Pictorial rendering (Continued)

Figure 6-40 shows the foreground in the illustration exposed and ready to paint.



Figure 6-40.—The exposed foreground.

Figure 6-41 is a finished airbrush illustration.

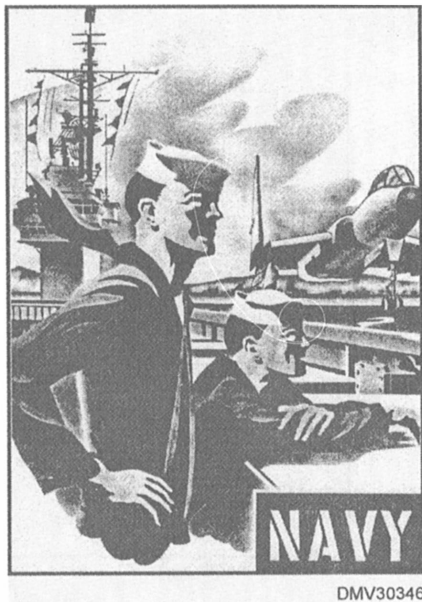

Figure 6-41.—The finished airbrush illustration.

Technical Illustrations

Introductions

Realistically rendering machine parts, mechanisms, or systems requires more precision in certain applications than pictorial rendering. In the illustrations that appear in operating instructions, manuals, visual aids, or medical journals, accuracy and correctness are imperative.

Technical illustrations

Technical illustrations factually or symbolically illustrate the construction, function, or operation of a machine, a physical phenomenon, an industrial process, or a biological theory. Accuracy is essential. Even the colors of the object are often dictated by the object itself, leaving little opportunity for creative licence.

The technique used to render technical illustrations depends on the way the illustration is used or reproduced and the time allotted for the job. Airbrush is particularly suited to technical illustration because of its flexibility, ease of control, shading, and color blending capabilities.

Make the initial drawing on paper. Do all corrections on the paper drawing before transferring it to illustration board. Any irregularities caused by corrections, abrasions, and dirt will show on illustration board. Indicate detailed shading on the paper drawing. Trace the line outline to illustration board and ink in using any drafting tools required.

Since shading has been predetermined, you may begin airbrushing anywhere on the drawing. Generally, start at the top of the illustration and work down or from the left side to the right in order not to disturb completed areas. You may expose more than one section of the drawing if the sections are not adjacent to each other and the spray pattern is not large.

Once the drawing is inked onto the illustration board, cover selected areas with frisket and cut the frisket only along the black outline of the object. Should the frisket pull away some of the black outline, it will be easy to correct with an ink pen.

In rendering technical illustrations, your knowledge of rendering the four basic shapes with an airbrush is invaluable. Approach each section as a basic form remembering always from where the light originates.

Continued on next page

Technical Illustrations, Continued

Technical illustrations (Continued)

To airbrush technical illustrations:

| Step | Action |
|------|---|
| 1 | Make an outline drawing on paper (figure 6-42). |
| 2 | Indicated detailed shading. Make sure the drawing is correct. |
| 3 | Transfer the drawing to illustration board using graphite on the reverse side of the drawing. The illustration board must be free of all imperfections. |
| 4 | Ink in the line outline of the drawing. |
| 5 | Beginning from the top to bottom or left to right, cover a section with frisket. |
| 6 | Cut the frisket with a sharp blade along the line outline of the object (figure 6-43). |
| 7 | Approach the airbrushing of sections as you would basic shapes. |
| 8 | Allow pigment to dry. |
| 9 | Continue this procedure as many times as necessary to complete the drawing (figure 6-44). |
| 10 | Remove all friskets. |
| 11 | Add details and highlights by hand with a brush. |
| 12 | Clean up the drawing surface. |

Continued on next page

Technical Illustrations, Continued

Technical illustrations (Continued)

Figure 6-42 shows a technical drawing outline.

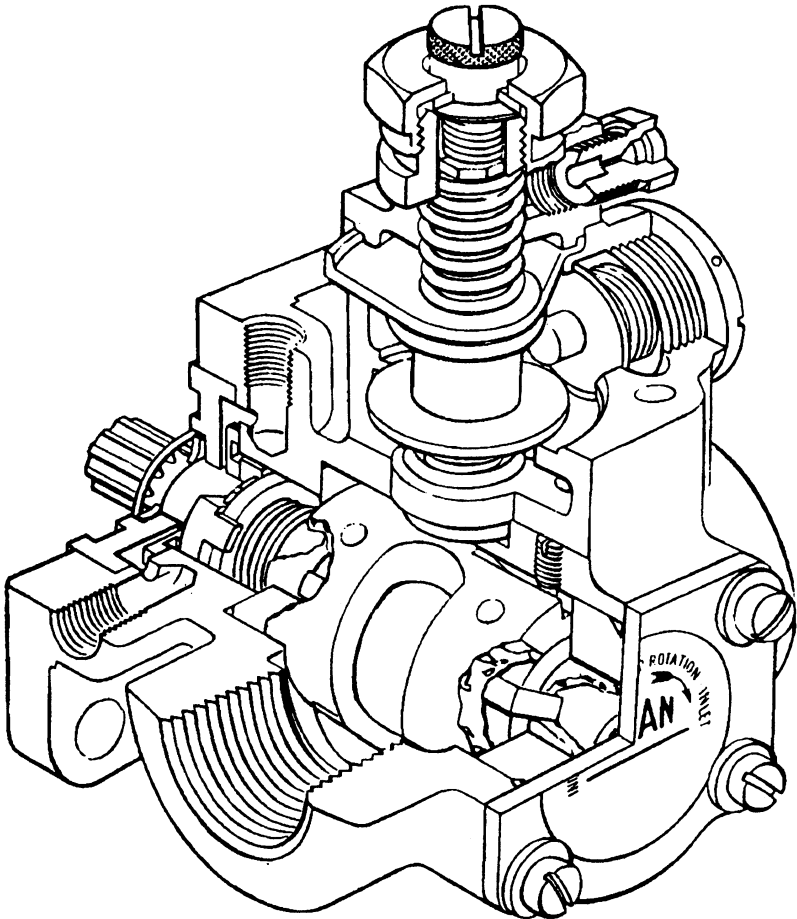

DMV30347

Figure 6-42.—Technical drawing outline.

Continued on next page

Technical Illustrations, Continued

Technical
illustrations
(Continued)

Figure 6-43 illustrates the technique of cutting a frisket on the illustration outline.

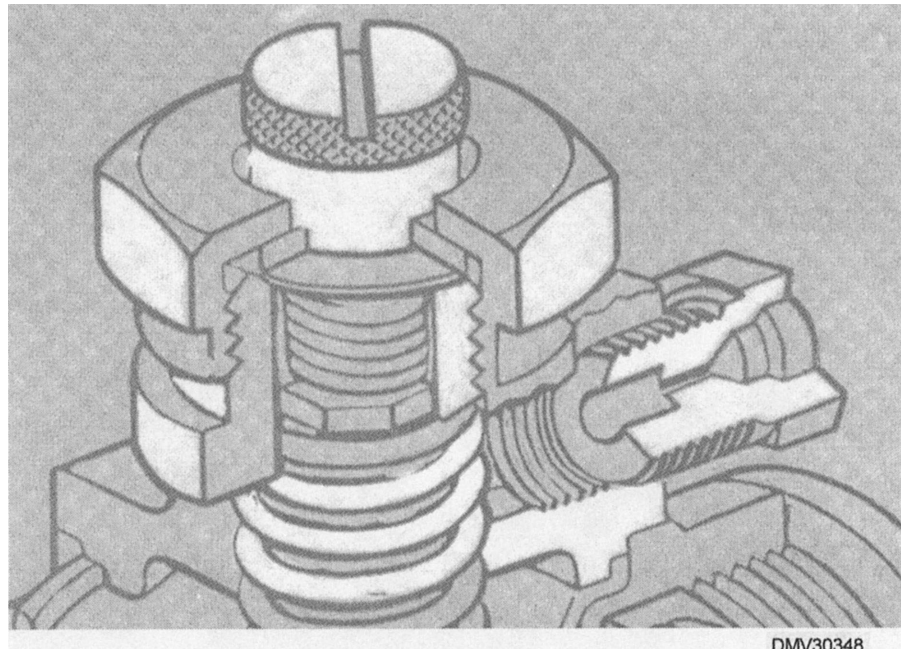

Figure 6-43.—A frisket cut out to expose a segment of the illustration for airbrushing.

Continued on next page

Technical Illustrations, Continued

**Technical
illustrations
(Continued)**

Figure 6-44 shows the frisket applied section by section until the illustration is complete.

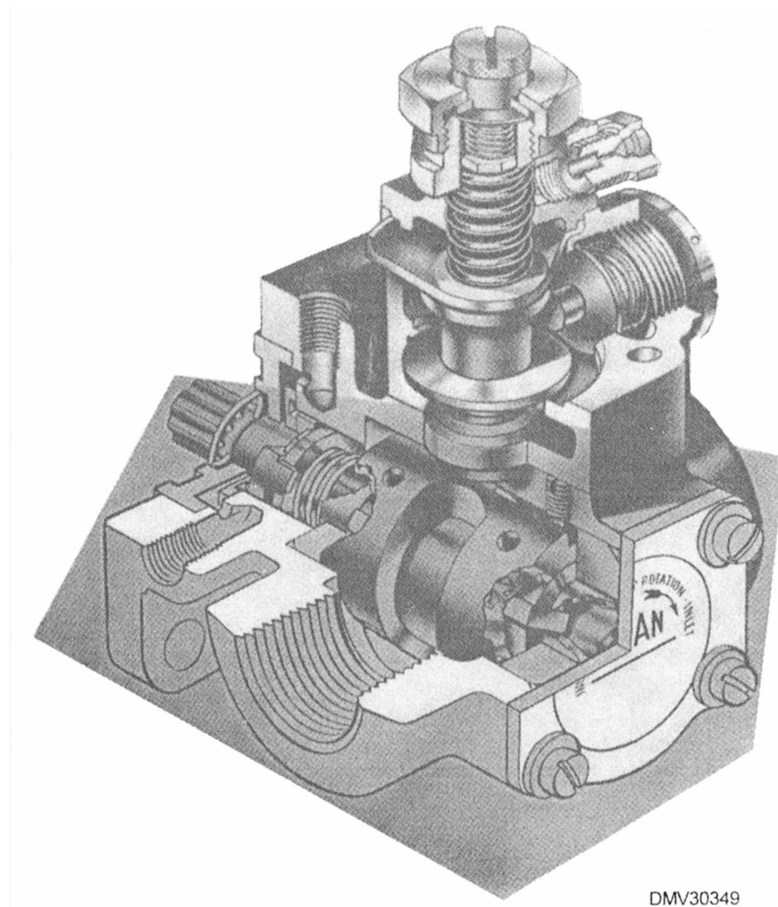

Figure 6-44.—Airbrush by sections until the illustration is complete.

Continued on next page

Technical Illustrations, Continued

Technical illustrations (Continued)

If airbrushing a complicated technical illustration with threaded areas and bolt heads, airbrush each thread or bolt one at a time until the entire section is finished.

Figure 6-44 illustrates the procedures for airbrushing inside threads.

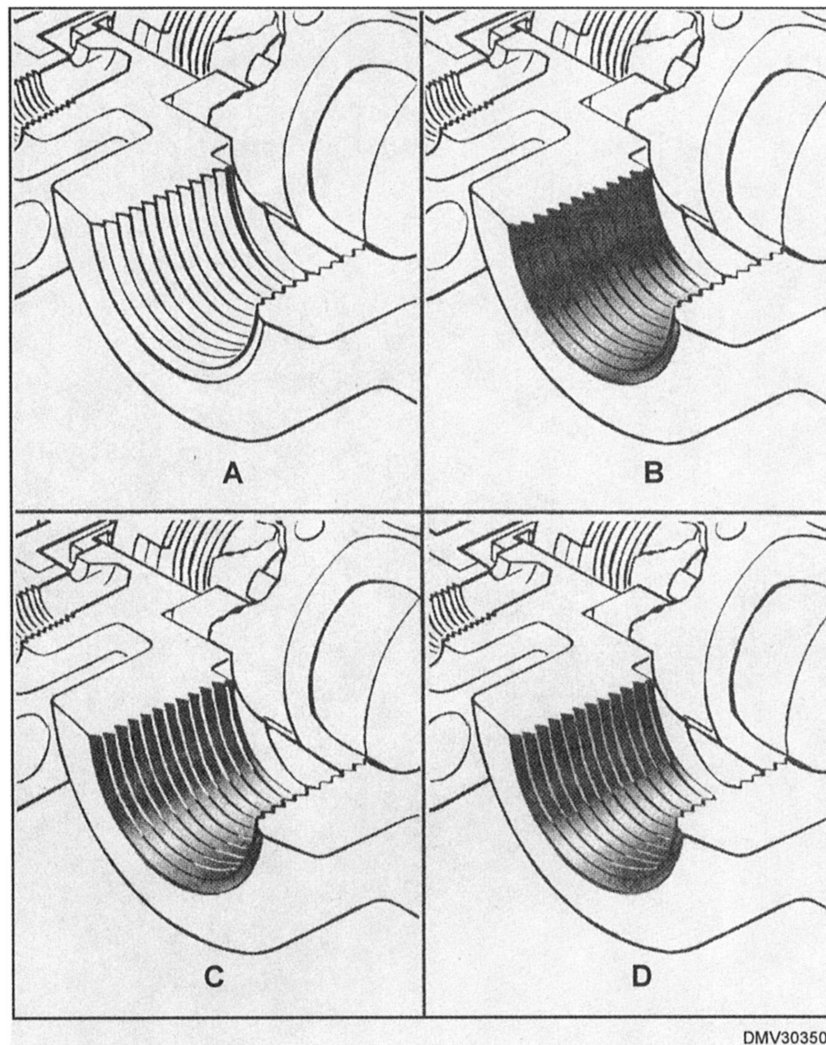

Figure 6-45.—Airbrushing inside threads.

Photographic Retouching

Introduction

There are many reasons to alter photographs with an airbrush. One reason is to combine one photograph with another. Another reason is to eliminate or reduce background images. And still another reason for altering photographs is to create a halo or vignette around the central image. Knowing how to alter photographs with an airbrush allows you to use otherwise mediocre photographs effectively.

Photographic retouching

The most important phase of photographic retouching is the preparation of the photo before you begin painting.

Mount photographs on illustration board allowing at least a 2-inch border all around the photo. The border will make handling the photograph easier during painting.

Modern photographic papers are covered with a thin layer of resin leaving a glossy surface that does not take pigments well. Using a talcum powder or Fuller's Earth on a cotton pad, rub the face of the photograph. This will slightly abrade the surface and provide tooth to hold pigments.

Make sure there are no fingerprints or scratches on the surface of the photograph. Place a piece of clean paper under your wrist as you paint to prevent depositing oils from your hands on the paper surface.

Apply pigments as you would on any airbrushed illustration. Should you make an error, wrap a small piece of cotton around the end of a paint brush or pencil and wipe off the pigment.

Clean up the photograph of overspray and spray a fixative over the photo if necessary.

Summary

Review

This chapter on airbrushes covers the types of airbrushes you are likely to find in a Graphics shop. The double-action airbrush, the most common brush, is explained in detail. Information on component parts associated with airbrush use, their assembly, and maintenance should help the novice set up and maintain an airpainting system. The DM will also find helpful, the sections on even tones, graduated tones, and different effects possible with the airbrush. The chapter ends by outlining procedures for creating effective pictorial renderings, technical illustrations, and photographic retouching.

Comments

Less than half of the shops in the fleet have airbrushes. Many shops have bits and pieces of airbrush paraphernalia but no longer have a complete system. If your shop has potential airbrush capabilities, it is worthwhile to develop the skills to use them. Airbrush art appears on license plates, motorcycle gas tanks, ballcaps, t-shirts, and just about everything. Airbrush art is everywhere and is a lucrative business in the civilian marketplace.

CHAPTER 7

PHOTOGRAPHY

Overview

Introduction You may think all you need to know as an Illustrator Draftsman is how to illustrate. However, you must also have a rudimentary knowledge of photographic principles (exposure, development, and printing) and film types. Your knowledge may save many hours of labor for you or for the Photographer's Mates or Lithographer's Mates in support shops. Obtain copies of the *Photography (Basic)*, NAVEDTRA 12700, and *Lithographer's Mate*, NAVEDTRA 10451, training manuals. For further study in photography, review the work of Ansel Adams, Edward Weston, Berenice Abbott, and Julia Margaret Cameron.

Objectives The material in this chapter enables you to do the following:

- State the procedures for positioning unexposed film or paper in process cameras.
- Define digital photography.
- Relate exposure time to f/stop settings.
- Identify film types and match them to specific purposes.
- Distinguish between reversals and negatives.
- Recognize film types used to photographically reproduce line art and continuous-tone art.
- Describe the effect enlarging or reducing photographs has on resolution and grain.
- Distinguish between cropping photographs and scaling photographs.
- State the purpose and procedures for indicating crop marks on photographs.

Continued on next page

Overview, Continued

Acronyms

The following table contains a list of acronyms that you must know to understand the material in this chapter.

| Acronym | Meaning |
|----------------|-------------------------------------|
| CCD | Charged Coupling Device |
| CD | Compact Disks |
| IR | Infrared Light |
| ISO | International Standards Association |
| mm | Millimeter |
| PMS | Planned Maintenance System |
| pixel | Picture Element |
| RC | Resin Coated |
| RH | Relative Humidity |
| SLR | Single-Lens Reflex |
| TTL | Through the Lens Metering |
| UV | Ultraviolet Light |

Continued on next page

Overview, Continued

In this chapter This chapter covers the following topics:

| Topic | See Page |
|--------------------------|-----------------|
| Cameras | 7-4 |
| Process and Copy Cameras | 7-8 |
| Electronic Cameras | 7-14 |
| Small-Format Cameras | 7-15 |
| Shutter Speed | 7-22 |
| Aperture | 7-25 |
| Lenses | 7-28 |
| Films | 7-34 |
| Papers | 7-41 |
| Finished Prints | 7-44 |

Cameras

Introduction You may have to operate cameras in the shop or small-format adjustable cameras in the field. Knowledge of camera types and basic functions of camera parts is essential. The theory of operation and maintenance procedures for different camera types is similar.

Camera theory Cameras are mechanical optical instruments that use light to record latent images on film or paper. Light, reflected from object surfaces or scenes, enters the camera through a lens. Lenses funnel light through a series of convex and concave, optically pure glass until the light reaches the film surface. Controlling the amount of light and the length of exposure to light determines how films register light until chemicals develop the image on the film.

Camera maintenance All cameras require maintenance. To keep cameras in your shop in optimum working condition, you should perform regular camera maintenance. The Navy Planned Maintenance System (PMS) has PMS cards detailing maintenance procedures and periodicities. Maintenance on process, copy, and small-format cameras may consist of any of the following actions.

Inspect all electrical cords for fraying or bare wire.

- Check the battery compartment for battery status:
 - is the battery present,
 - is the battery fresh, and
 - is the battery swollen or leaking.
 - Clean optical surfaces with lint-free cloths or chamois.
 - Clean mirrored surfaces with soft camel hair brushes.
 - Remove debris and lint from bellows, copyboard, and film plane.
 - Lightly oil rotating handwheels, cranks, and worm gears.
 - Wipe down camera body with lint-free cloths or chamois.
 - Dust inside film back with soft camel hair brushes.
 - Remove batteries before storing the camera for any length of time.
-

Continued on next page

Cameras, Continued

Camera planes Cameras consist of three parallel planes: the copy plane, the lens plane, and the focal plane.

COPY PLANE: The copy plane is where the copy, object, or scene exists. For small hand-held cameras, it is the scene or object. For copy or process cameras, it is a glass copyboard that holds the original copy in place. The most common size copyboard is 18 by 24 inches, with gridded reference lines to help align the original copy. A vacuum creates suction to pressure flatten copy placed on the copyboard. On process and copy cameras, the copy plane may move on tracks for proportional reductions or enlargements.

LENS PLANE: The lens plane is where the lens is located. On small adjustable cameras and some process and copy cameras, the lenses are interchangeable. On copy and process cameras, the lens plane moves on tracks for proportional reductions or enlargements.

FILM or FOCAL PLANE: The film plane holds the film in place in the back of the camera. The film plane is sometimes called the focal plane because the image focuses on ground glass or mirrors located at the focal plane before exposure. On process or copy cameras, the film plane may also have a filter attachment for halftone or color separation work.

Figure 7-1 shows the different parallel planes of a camera.

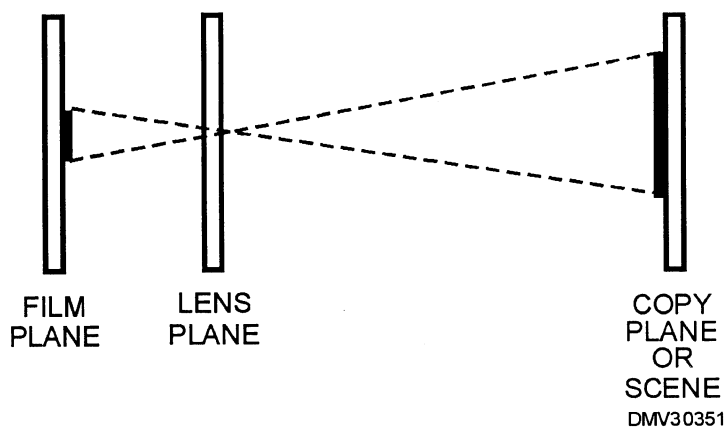

Figure 7-1.—The three parallel planes of a camera.

Continued on next page

Cameras, Continued

Camera adjustments

Each of the three parallel planes of a camera has further adjustments to control the size, sharpness, brightness, and contrast of images. Scales control 'image size. Focus and aperture rings, along with shutter speed and film speed dials, control image resolution.

SCALES: Scales on process and copy cameras control percentages of reduction or enlargement. Most of these cameras reduce to 50% and enlarge to 300%, or any range in between. Scales are usually located on the head of process and copy cameras.

FOCUSING CONTROL: Except for cheaply made cameras, most cameras can focus or adjust the sharpness of images striking the film or focal plane. Images on the ground glass of copy or process cameras appear fuzzy until you rotate the handwheels or cranks of the three planes. You may need a loup or magnifier to focus sharply. On small adjustable cameras, the image appears in the viewfinder as a ghost or double image, or as broken images that you align into one image. To align images, rotate a sleeve on the lens until the two images appear superimposed (directly on top of the other). Specialty focusing screens, such as hairlines and grids, are available to accommodate individual preferences.

Figure 7-2 illustrates the most common focusing screen images.

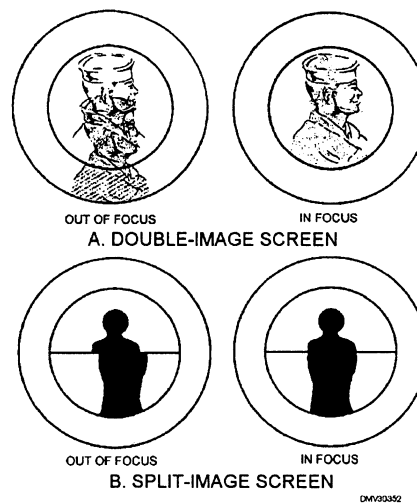

Figure 7-2.—Common focusing screens: A. Double-image; B. Split-image.

Continued on next page

Cameras, Continued

Camera adjustments (Continued)

BELLOWS: Bellows are accordion-folded segments between the lens and the film plane of most process and copy cameras. Bellows maintain light-tight integrity during enlargements and reductions. The use of bellows on small adjustable cameras is limited to macro (close up) or copy work.

EXPOSURE CONTROLS: Exposure controls involve shutter speed dials and aperture rings. Once the copy plane, lens plane, and film plane are correctly positioned, select the settings for exposing film to the light. The length of exposure is called *shutter speed*. The amount of exposure is called *aperture*. Automated cameras may set shutter speed, aperture, or both for you. Cameras that require you to select the aperture and automatically set the corresponding shutter speed are called *aperture priority*. Cameras that automatically select apertures based on your shutter speed-selection are called *shutter priority*. The shutter speed dial is located on the head of the camera. The aperture ring is a collar around the lens. Most cameras allow manual manipulation or override of the automatic mode.

FILM SPEED: Film speed indicates how sensitive or receptive film is to light. Every film type has a rated speed set by the International Standards Organization (ISO). The film speed is referred to as *ISO*. Set the camera film speed dial to reflect the ISO of the film. Generally, the lower the ISO rating, the slower the film records light. A slow film requires more light and either longer shutter speeds or larger aperture openings to achieve proper film exposure. Slow film has a less grainy appearance in print, which results in increased resolution or sharpness in enlargements.

Process and Copy Cameras

Introduction

Some Navy graphics shops and most Navy print shops use process or copy cameras. You should understand the limitations and capabilities of these cameras before you begin creating art intended for photographic reduction or enlargements.

Process cameras

Process cameras are large studio-type cameras that use sheet film or paper. These cameras may be horizontal or vertical in construction. Horizontal process cameras are either darkroom cameras or gallery cameras. Darkroom cameras have the film plane built into a wall. The other side of the wall is in the darkroom. Darkroom cameras are loaded with film from the darkroom. Repositioning copy requires you to exit the darkroom and enter the part of the shop or studio that houses the forward part of the camera. Gallery cameras are free-standing horizontal units. Vertical process cameras take up less space. Both horizontal and vertical process cameras are available with fully automated exposure control. Some of the newer process cameras automatically develop the film or paper after exposure.

Figure 7-3 shows examples of the two types of process cameras.

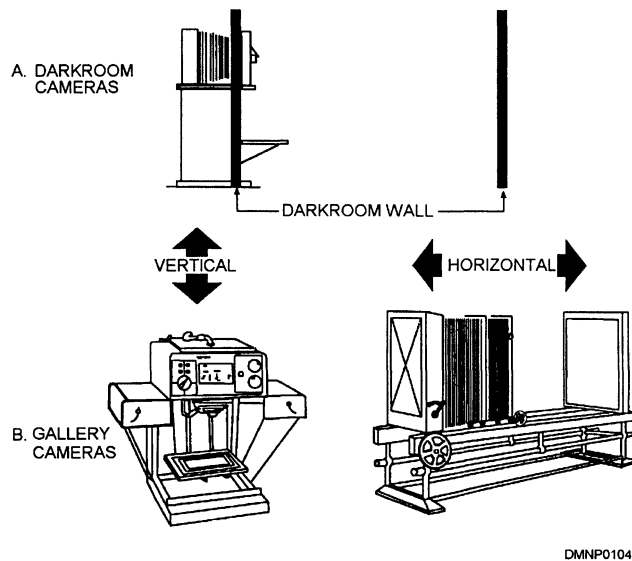

Figure 7-3.—Process cameras: A. Darkroom cameras;
B. Gallery cameras.

Continued on next page

Process and Copy Cameras, Continued

Process camera major components and adjustments

The major components of a process camera are a copy plane, a film plane, and a lens plane. Adjustments include scales (the ratio of reduction or enlargement), shutter speed (timer), and aperture. Copy or process cameras may also have an optional built-in lighting system.

Figure 7-4 shows a basic process camera with the major components and adjustments identified.

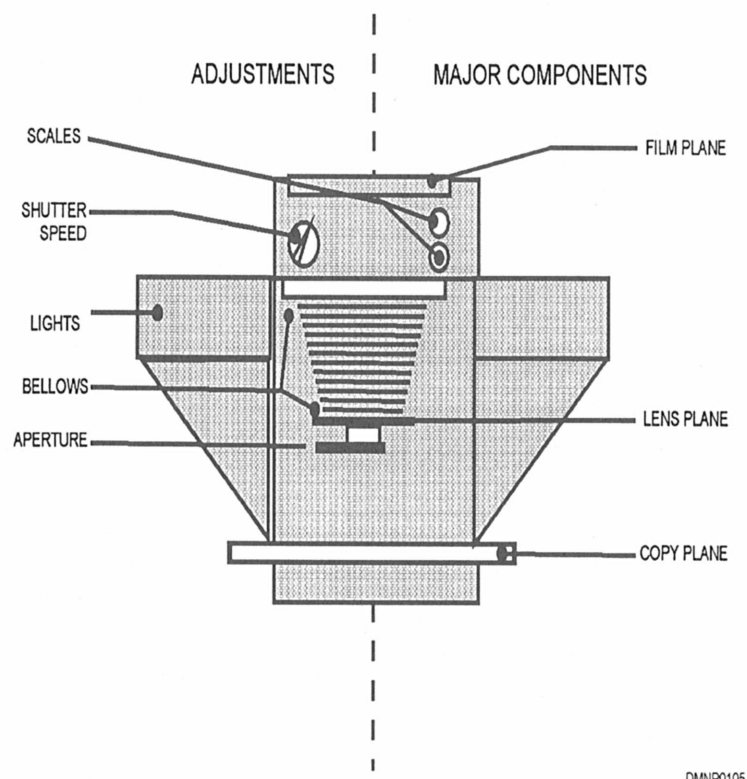

Figure 7-4.—Process camera nomenclature.

Continued on next page

Process and Copy Cameras, Continued

Using a process camera Using a process camera can be frustrating if you approach the task without regard for accuracy.

To use a process camera:

| Step | Action |
|-------------|--|
| 1 | Visually inspect the camera. Clean the camera of any lint and replace any burned-out bulbs. |
| 2 | Set the scales on the head of the process camera to reflect the amount of reduction or enlargement you require in the finished image. Make sure the scales are accurately set. |
| 3 | Lift the glass from the copyboard and position the original copy. |
| 4 | Open the aperture wide open. This will increase the amount of light through the bellows and make focusing easier. |
| 5 | Adjust camera lights for even illumination. |
| 6 | Focus the image on the ground glass of the focal plane. Use a loup for critical focus. |
| 7 | Select an aperture setting and adjust the aperture ring. |
| 8 | Select a shutter speed and set the camera timer. |
| 9 | Turn off the lights in the darkroom. |
| 10 | Position the film on the film or focal plane with the emulsion facing the light source and close the camera back. |
| 11 | Turn on the vacuum to the copyboard and the film back. |
| 12 | Expose the film by tripping the shutter release activating the timer. |
| 13 | Turn off vacuum and lights. |
| 14 | Remove the film from the film plane. |
| 15 | Develop the film. |

Continued on next page

Process and Copy Cameras, Continued

Sheet film and print development

Sheet films and papers can be developed conventionally in a four-tray manual process or with an automatic processor.

Four-tray development

Conventional development of photographic sheet films and papers is a four-tray process. The first tray contains *developer*. Developer is a chemical that reacts with the film or paper to make images appear. The second tray contains *stop bath*, a weak acetic acid that neutralizes the action of the developer. The third tray contains *fixing agent*. The fixer stabilizes the developed image by chemically removing undeveloped light-sensitive crystals. The fourth tray contains *water*. Water removes chemicals from the film or paper. Allow films or papers to thoroughly rinse in water after development. If the water wash is insufficient, the film or paper continues to chemically change resulting in uneven streaking or brownness.

Figure 7-5 illustrates the process for conventional development of sheet films and papers.

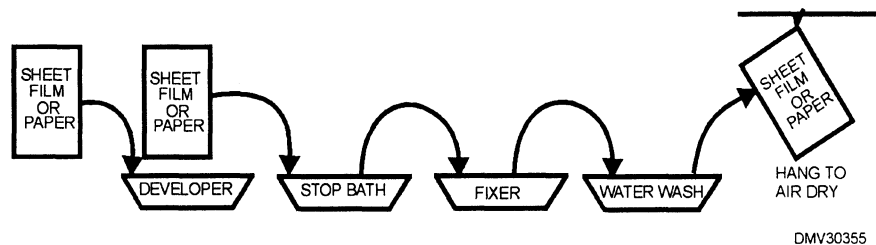

Figure 7-5.—Conventional development of sheet films and papers.

The temperature of each tray's contents should be approximately 70 degrees. Temperature variation between trays should not exceed 5 degrees. The warmer the liquids in the trays, the faster action takes place. The disadvantage of excessively warm temperatures is rapid overdevelopment. The disadvantages of cooler than required temperatures is slow development and weak images. Extreme temperature variations cause increased grain or reticulation. Do not put your hands into the chemicals. The warmth of your hands will raise the temperature of the solutions. Moving your hand from one tray to another will contaminate them. Use tongs to move the film or paper through the development process. Hang films and papers by one corner to air dry.

Continued on next page

Process and Copy Cameras, Continued

Automatic sheet film and paper processing

Processing sheet films and papers with automatic processors is a two-step process involving *activation* and *stabilization*. After exposure, place the film or paper between the rollers of the automatic processor. The rollers guide the film or paper first through a tray of activator that develops the image, then through a tray of stabilizer. Finally, the rollers squeegee the excess chemical from the film or paper surface. Wash the film or print with clean cool water before hanging the print to dry.

Figure 7-6 shows the process of film or paper development in an automatic processor.

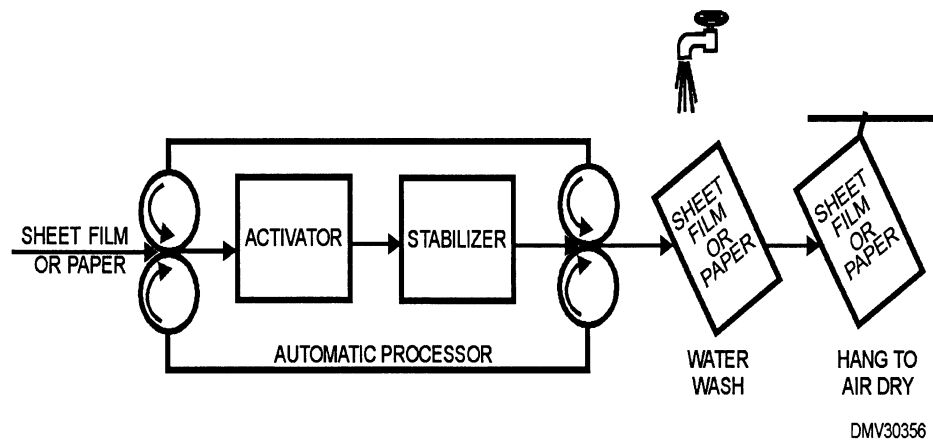

Figure 7-6.—An automatic processor for sheet films and papers.

Printing

Normally prints made from sheet films exposed by process cameras are on a one-to-one (same size) ratio. The print is later cut and pasted onto a layout and prepared for alteration or reproduction. Development procedures for prints is the same as development of sheet films.

Continued on next page

Process and Copy Cameras, Continued

| | |
|--------------------------------|--|
| Copy cameras | Copy cameras are similar to process cameras but smaller. Many copy cameras are simply small-format cameras (lens and focal plane) on stands with copyboards (copy plane) and adjustable light systems. |
| Copy camera lenses | Lenses for copy cameras are usually not interchangeable unless the camera used in the stand is a detachable small-format camera. Generally, copy camera lenses are 50mm in length with some lenses having super close-up (macro) capabilities. |
| Copy camera film backs | The camera back or film plane may house 35mm, 120mm, or instant-imaging film. The film type used in the film back may be negative- or positive-imaging or color or black-and-white film or paper. |
| Copy camera adjustments | Copy cameras adjust in the same way as small-format cameras. Load the film into the film back. Set the ISO and select a shutter speed and/or aperture. |
| Copy camera exposure | Copy cameras have a shutter-release button or a cable release connected to the shutter-release button. The cable release minimizes camera movement when the shutter is depressed. |

Figure 7-7 compares a shutter-release button with a cable release.

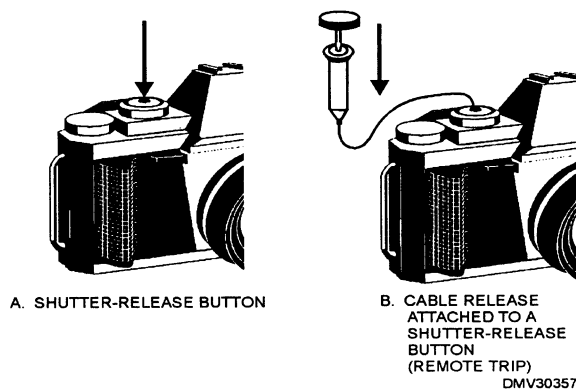

Figure 7-7.—Shutter releases: A. Shutter-release button; B. Cable release.

Electronic Cameras

Introduction

Computer technology has spawned a new photographic theory based on the principles of capture, enhancement, and display. With fleetwide restrictions on hazardous material and chemistry, you may find less traditional photographic methods and more electronic photography in graphics shops.

Electronic photographic capture

Electronic photography captures images as magnetic impulses. The two types of electronic cameras currently used in the Navy are the still-video camera and the digital camera.

STILL-VIDEO CAMERAS: The still-video cameras record images as magnetic impulses and place them on 2-inch floppy disks. Images are captured by two charged-coupled device (CCD) chips. One chip stores luminance information and the other separately records chrominance information. Still-video disks provide a 720,000-pixel image. Images are stored on the floppy disk as either a frame or a field. When selecting frame storage, each picture records on two tracks, and up to 25 images fit on one disk. Selecting field storage records each picture on one track, allowing up to 50 images on a disk. Recording in the field mode reduces clarity and resolution.

DIGITAL CAMERAS: Digital cameras capture images and transfer them to a highly sensitive CCD that converts them directly into digital information for storage in computer memory or on disks. Digital images easily download to computers for manipulation, enhancement, printing, or transmission without a loss in resolution.

Electronic imagery capture

Another form of electronic imagery capture is conventional photographic exposure and development, followed by electronic scanning, to convert the image into a digital format.

Electronic imagery enhancement

With the digital information in computer memory, processing software allows for corrections and enhancement similar to the alteration of photographs in the darkroom.

Electronic imagery display

Electronic images may be displayed on computer screens, transferred to slides or video tape, or printed on paper or film. Images may also be directly imported into documents using desktop publishing software. Store electronic images on floppy disks, compact disks (CD), or in harddrives.

Small-Format Cameras

Introduction Often DMs are required to fill in for the duty photographer or to create and duplicate slides. The camera you use for this work is most often a small-format portable camera.

Small-format cameras Small-format cameras refer to any cameras that produce negatives on a film size of 35mm or less. Generally hand-held and portable, small-format cameras allow maximum freedom of movement and large numbers of exposures without reloading the camera. The accessories, lenses, and flash equipment are easily carried. The most popular professional small-format cameras are the 35mm rangefinder and single-lens reflex (SLR).

Rangefinder cameras Rangefinder 35mm cameras focus images on the film or focal plane after diverting light reflected from surfaces through a series of angled mirrors. The viewing lens and the lens through which the exposure is made are not the same. The difference between the offset position of the two lenses is called *parallax*. What you see in the eyepiece is not necessarily what you record on film. Most 35mm rangefinder cameras automatically correct any differences in parallax.

Figure 7-8 shows how images pass through rangefinder cameras.

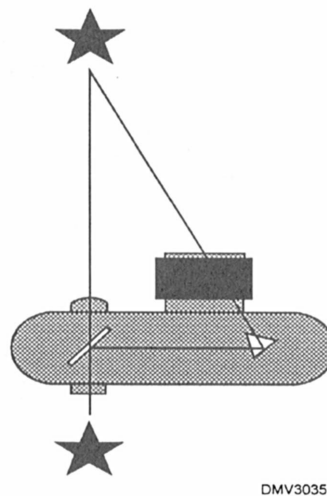

Figure 7-8.—How images pass through a rangefinder camera.

Continued on next page

Small-Format Cameras, Continued

Single-lens reflex cameras

In single-lens reflex cameras, or SLRs, the viewing lens is the same as the lens that records the image; hence the name, single-lens reflex. The viewing and exposure system of SLRs consists of three main elements: a hinged mirror, a matte focusing screen, and a five-sided glass prism called a pentaprism. Images enter the lens and strike the mirror. The mirror deflects the image through the pentaprism onto the matte focusing screen in the eyepiece. During exposure, the mirror flips out of the way allowing the light to record on film at the film plane.

Figure 7-9 shows how images pass through an SLR.

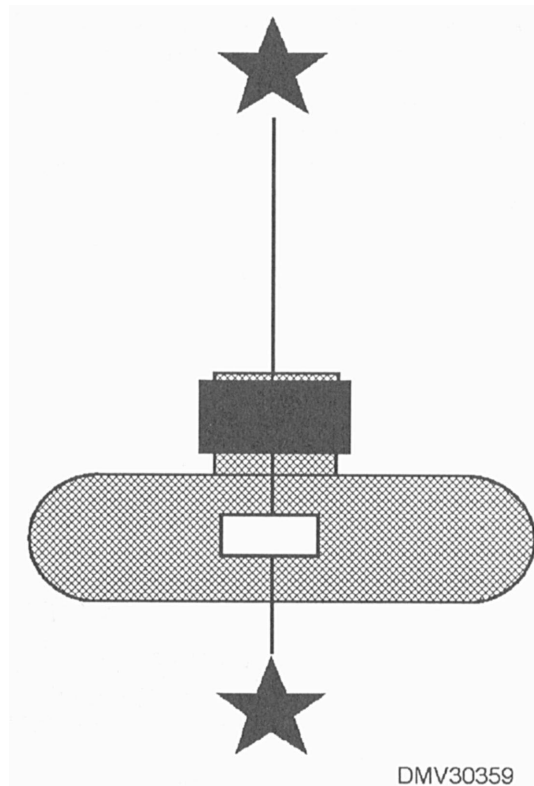

Figure 7-9.—How images pass through an SLR camera.

Continued on next page

Small-Format Cameras, Continued

Camera adjustments

The body of 35mm cameras with interchangeable lenses have an ISO selection dial, a focal plane (shutter speed dial), a frame indicator, a film release, and a light meter. Focus rings and aperture rings are usually part of the lens.

ISO selection dial

The International Standards Organization rates each film for sensitivity by assigning it a numerical code. Located on top of a camera body is a small dial with numbers that incrementally increase or decrease by hundreds, for example, 200, 400, or 1000. Set the dial to the number that most closely corresponds to the ISO ratings on the film cassette you are using. Some cameras require the operator to lift the dial before turning it to the appropriate ISO number.

Figure 7-10 is an example of a film-speed dial.

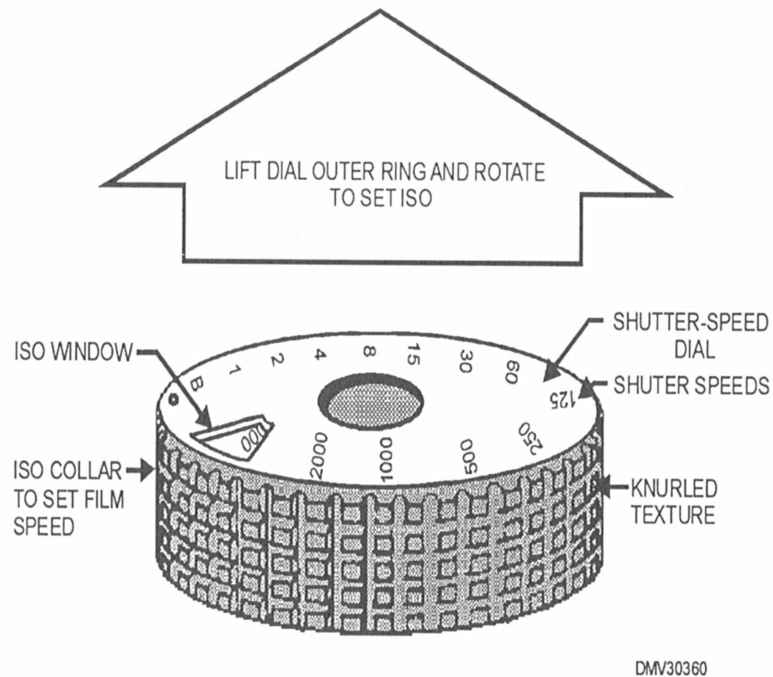

Figure 7-10.—Film-speed dial.

Continued on next page

Small-Format Cameras, Continued

Shutters

Camera shutters control both the exact instant film is exposed to light and the duration of exposure. The two types of camera shutters are the leaf shutter and the focal-plane shutter.

Leaf shutters

Leaf shutters consist of several blades of spring steel that overlap each other. Pressing the shutter release button rapidly moves the blades apart or open to allow light to strike the film. The blades remain open for the duration of the preset exposure time (shutter speed) before springing shut again. Leaf shutters may be used with a flash unit at all shutter speeds.

Figure 7-11 illustrates the operation of leaf shutters.

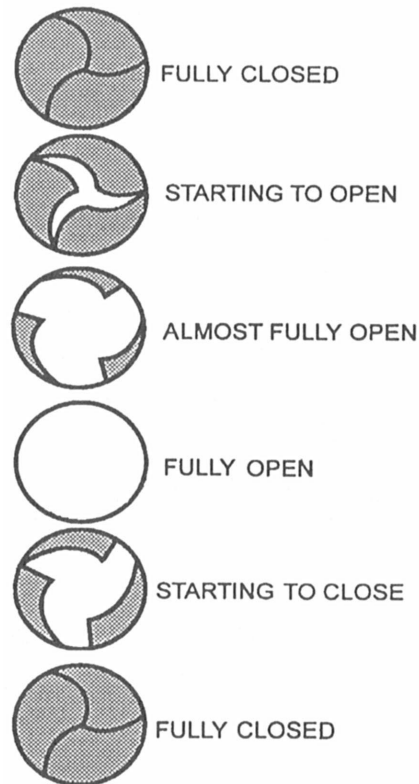

Figure 7-11.—Leaf shutter operation.

Continued on next page

Small-Format Cameras, Continued

Focal-plane shutters

Focal-plane shutters are essentially two light-proof cloth or thin metal curtains in front of the film plane that move across the film in the same direction. As the first curtain moves from one side to the other, the second curtain follows. The speed at which the curtains move is called shutter speed. When a slow shutter speed is set, the second curtain waits a relatively long time and the space between the first and second curtain is wide. Shutter speed dials are located on the camera body and indicate time in fractions of a second. Shutter, aperture, and mirror work together in a precise sequence that repeats each time the shutter release trips. Most 35mm cameras have focal-plane shutters. Focal-plane shutters simplify camera construction and make interchangeable lenses smaller, lighter, and less expensive than leaf shutters.

Figure 7-12 shows a focal-plane shutter.

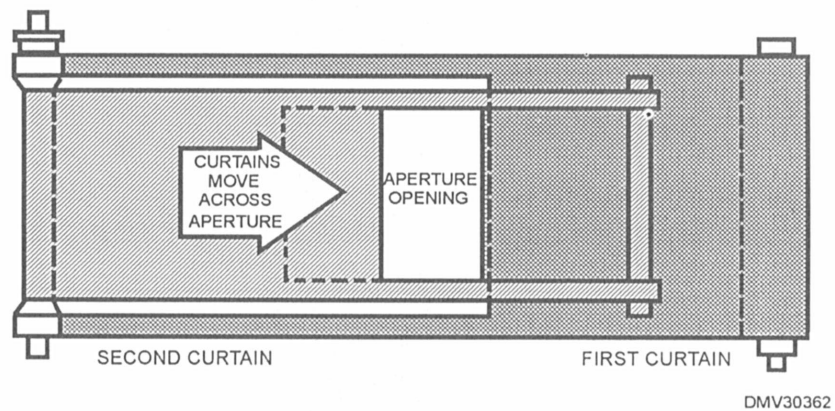

Figure 7-12.—Focal-plane shutters.

Frame indicator

The frame indicator is a small window near the shutter-speed dial that displays the number of pictures taken. Each time the back of the camera opens, the number resets to “0.”

Continued on next page

Small-Format Cameras, Continued

Film release

The film-release button, located on the bottom of camera bodies, releases the tension on the film roll winding inside the camera body. Make sure you depress the film release before attempting to rewind film into the canister or preparing a double exposure. Not releasing tension on the film will tear film and sprocket holes. The film release does not open the film back or expose film.

Light meters

A light meter inside the camera body reads the amount of light entering the lens and recommends an overall ideal aperture setting. Most 35mm SLRs have built-in light meters that read through the lens (TTL). Light meters may read light falling on the mirror, the shutter curtain, the focusing screen, or the film surface and produce a display in the viewfinder indicating the correct exposure setting. In the manual mode, set the lens aperture to correspond with the meter reading. In the automatic mode, the camera sets the exposure and informs you of the setting. To compensate for unusual lighting conditions or for creative effect, override the automatic selection and manually set the aperture. Light meters in 35mm cameras are ordinarily powered by batteries.

Figure 7-13 shows a light meter reading from the eyepiece of a camera.

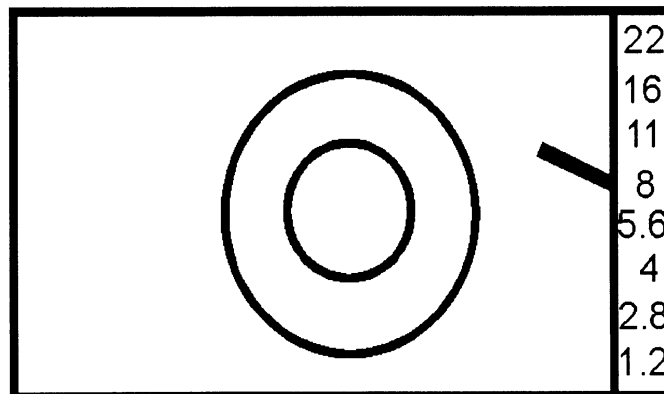

DMV30363

Figure 7-13.—A TTL light meter reading of f/8 from the eyepiece of a camera.

Continued on next page

Small-Format Cameras, Continued

Using a 35mm camera

To use a small-format or 35mm camera:

| Step | Action |
|------|---|
| 1 | Check the camera for cleanliness and battery freshness. Clean camera and replace battery, if required. |
| 2 | Set the ISO dial to correspond with the ISO rating of the selected film. |
| 3 | Open the film back and insert the film, with the leader on the bottom. Be sure to engage the film sprockets so that the film winds correctly on the empty right-hand spool. |
| 4 | Close the film back. Trip the shutter release and wind the film until it indicates the first frame in the frame counter. |
| 5 | Assess local conditions and set the shutter speed for the desired speed of exposure. |
| 6 | Select the proper lens and place it on the camera body clicking it into place. |
| 7 | Look through the lens at a subject for a test meter reading. Pushing the shutter release button partially down produces a meter reading in the eyepiece without tripping the shutter. |
| 8 | If you are not manually operating the camera, set the camera to the automatic mode by placing the "A" on the lens aperture ring across from the aperture indicator mark. |
| 9 | Expose the film. Make sure to wind to the next frame after each exposure so that you are always ready to shoot. |
| 10 | Depress the film release button before rewinding exposed rolls of film back into their canister and opening the film back to remove the film. |

Shutter Speed

| | |
|-------------------------------|--|
| Introduction | Shutter speed and aperture settings control the quality of exposure in photography. Understand the effect one has on the other. |
| Shutter speed | Shutter speed is the amount of time, in fractions of a second, that it takes the opening in the shutter curtain to pass across the film surface. |
| Shutter speed settings | <p>A dial on the camera body is marked with industry standard shutter-speed settings of T or \checkmark, B, 1, $\frac{1}{2}$, $\frac{1}{4}$, $\frac{1}{8}$, $\frac{1}{15}$, $\frac{1}{30}$, $\frac{1}{60}$, $\frac{1}{125}$, $\frac{1}{250}$, $\frac{1}{500}$, $\frac{1}{1000}$, and $\frac{1}{2000}$. Select the interval you want the shutter to remain open by moving a lever or dial to that particular setting. It should easily click into place. You cannot select a shutter speed in between two indicated speeds.</p> <p>T or \checkmark: At the setting marked “T or \checkmark,” the shutter opens the first time the shutter-release button is pressed and remains open until the shutter-release button is pressed again.</p> <p>B: At the setting marked “B,” the shutter remains open as long as the shutter-release button is held down and closes when released.</p> <p>$\frac{1}{30}$: This setting is the longest recommended shutter speed for hand-held exposures. For any setting longer than $\frac{1}{30}$ second, set the camera on a tripod or sturdy support.</p> <p>$\frac{1}{60}$: This is generally the recommended shutter speed for flash photographs. At this speed, the shutter speed, aperture, and flash are synchronized for optimum exposure. Flash synchronization may also be indicated by numbers in red or another color or by a lightning bolt on the shutter speed dial.</p> <p>Long (slow) shutter speeds: Slower shutter speeds (T or \checkmark, B, 1, $\frac{1}{2}$, $\frac{1}{4}$, $\frac{1}{8}$, $\frac{1}{15}$, and $\frac{1}{30}$) require more stable platforms or tripods to minimize blur. Not intended to stop action, slow shutter speeds work best in low light situations with little movement. The results can be very fine grain, overall image sharpness, and subtle gradations of tone.</p> <p>Short (fast) shutter speeds: With faster shutter speeds ($\frac{1}{60}$, $\frac{1}{125}$, $\frac{1}{250}$, $\frac{1}{1000}$, and $\frac{1}{2000}$), the faster the shutter speed, the more likely you are to stop action. One drawback to faster shutter speeds is that less of the overall image will be focused.</p> |

Continued on next page

Shutter Speed, Continued

Shutter speed dial

Figure 7-14 shows a shutter-speed dial.

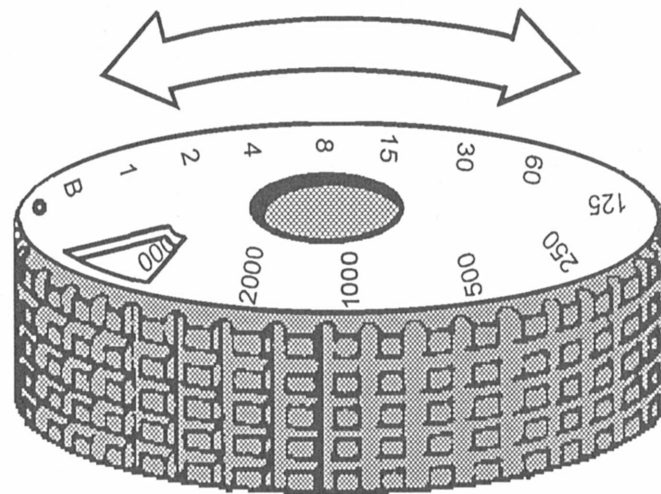

DMV30364

Figure 7-14.—A shutter-speed dial.

Trouble-shooting causes of blur

The following table lists common shutter-speed problems resulting in blur.

| Appearance | Cause | Correction |
|---|--|--|
| Subject blurry, background or some of the picture in focus. | Subject moved. Photographer focused on wrong subject. | Stabilize subject. Refocus on subject. |
| Background blurry, subject or central image in focus. | Out of depth of field. | Use a slower shutter speed or different f/stop. |
| Everything blurry. | Camera moved. | Stabilize camera. Use a faster shutter speed. |

Continued on next page

Shutter Speed, Continued

Recommended shutter speeds

The following table lists recommended shutter speeds for objects moving in the scene.

| Speed MPH | Action | Distance (in feet) | Direction of action across field of view/diagonally/straight toward or away | | |
|-----------|--|--------------------|---|--------|--------|
| 5 | Slow walk, moving hands | 12 | 1/500 | 1/250 | 1/125 |
| | | 25 | 1/250 | 1/125 | 1/60 |
| | | 50 | 1/125 | 1/60 | 1/30 |
| | | 100 | 1/60 | 1/30 | 1/15 |
| 10 | Fast walk, slow-moving vehicles | 12 | 1/1000 | 1/500 | 1/250 |
| | | 25 | 1/500 | 1/250 | 1/125 |
| | | 50 | 1/250 | 1/125 | 1/60 |
| | | 100 | 1/125 | 1/60 | 1/30 |
| 25 | Running, sports, very active people, vehicles moving at a moderate rate of speed | 12 | 1/2000 | 1/1000 | 1/500 |
| | | 25 | 1/1000 | 1/500 | 1/250 |
| | | 50 | 1/500 | 1/250 | 1/125 |
| | | 100 | 1/250 | 1/125 | 1/60 |
| 100 | Very fast activity | 12 | 1/2000 | 1/2000 | 1/1000 |
| | | 25 | 1/1000 | 1/1000 | 1/500 |
| | | 50 | 1/500 | 1/500 | 1/250 |
| | | 100 | 1/250 | 1/250 | 1/125 |

Aperture

Introduction

Aperture settings are related to and work in conjunction with shutter speeds. Understanding the relationship between the two factors should improve your ability to shoot correctly exposed films and papers with less effort.

Aperture

The aperture regulates the diameter of a lens opening. The diameter of the lens opening controls the amount of light or luminance that strikes the film plane. Aperture is also referred to as *f/stop*. The term *f/stop* expresses the relationship between the focal length of the lens and the diameter of the aperture opening. The most commonly used aperture-control device is the *iris diaphragm*.

Iris diaphragm

The iris diaphragm is an adjustable device that fits into the barrel of a lens or shutter housing. It consists of a series of thin, curved, metal blades that overlap each other and fasten to a control ring on the lens barrel. The blades of the diaphragm move in unison as the control ring rotates, forming an aperture opening of any size. An iris diaphragm resembles the iris in the human eye; hence the name, iris diaphragm.

Figure 7-15 shows how similar the iris diaphragm is to the human eye.

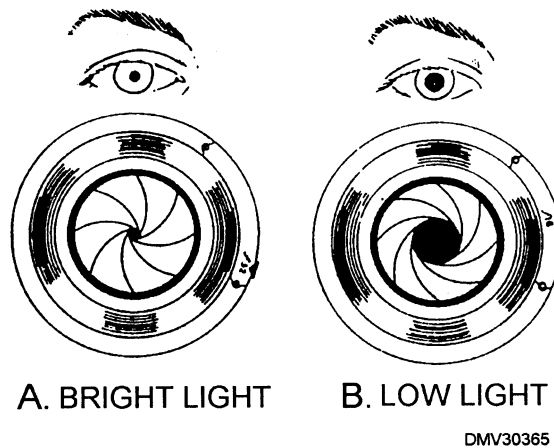

Figure 7-15.—Iris and iris diaphragm under light:
A. Bright light; B. Low light.

Continued on next page

Aperture, Continued

Aperture settings

Aperture settings (f/stops) regulate the intensity of light allowed to strike the film surface. The aperture control ring on the lens barrel is marked in a series of f/stops that relate to the openings of the iris diaphragm. F/stops control overall image sharpness, depth of field, and partially correct lens aberrations. Adjacent numbers in the series of f/stops admit light in a proportion of 2 to 1. For example, changing aperture setting from f/5.6 to f/8 changes the amount of light by decreasing the light by half, a procedure called *stopping down*. Changing from f/5.6 to f/4 doubles the light. This change is called *opening up*. When the diaphragm is set to its smallest numerical aperture, it is said to be *wide open*. The larger the f/stop numbers, the smaller the opening and the less light admitted.

Figure 7-16 illustrates the differences between f/stop openings.

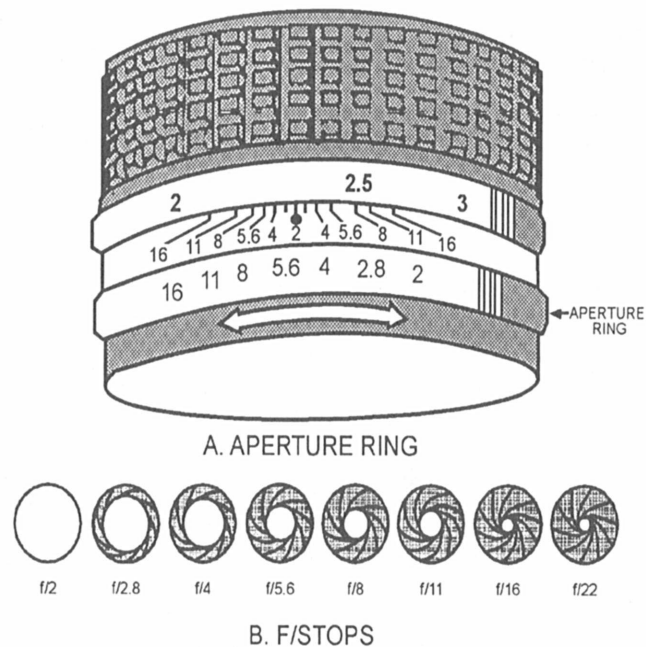

Figure 7-16.—Aperture: A. Aperture ring; B. Aperture openings at various f/stops.

Continued on next page

Aperture, Continued

Aperture settings without light meters

There may be times when you do not have access to light meters or the light meter in your camera is not working. You can improve your chances of taking usable exposures if you follow the f/16 rule. The f/16 rule is based on the correct exposure for an average front-lighted subject under bright, sunny conditions.

To use the f/16 rule:

| Step | Action |
|------|--|
| 1 | Set the aperture of the camera to f/16. |
| 2 | Set the shutter speed on the camera to most closely approximate the rated ISO of the film. For example, if the film is rated at ISO 125, set the shutter speed at 1/125 of a second. |

The f/16 rule is a way to calculate alternate f/stops should environmental conditions deteriorate. The following table lists different aperture settings for daylight conditions.

| Condition | f/stop |
|---------------------------------|--------|
| Bright sun, light sand, or snow | f/22 |
| Bright sun | f/16 |
| Cloudy but bright | f/11 |
| Cloudy | f/8 |
| Overcast or open shade | f/5.6 |

Lenses

Introduction

Selection of the appropriate lens for the job ensures optimum resolution in reproduction. If you duplicate slides or photographs without available negatives, your selection of lenses could mean the difference in doing a good job or not being able to do the job at all. Review *Illustrator Draftsman* Volume 1, chapter 1, for elementary information on lenses.

Lens interchangeability

Lens interchangeability is one of the best features of SLR cameras. When you cannot change your viewpoint or the position of the camera, or when different focal-length lenses will enhance your subject, change lenses. Most SLRs are designed with an manufacturer-exclusive method of lens attachment. Some SLR manufacturers use screw-mounts; others use bayonet mounts. Lenses from different manufacturers are either incompatible or require special adapters to fit the camera body or align electronic contacts. Do not force lenses onto camera bodies. Forcing lens mounts may irreparably damage the electric contacts that feed light meter, shutter speed, and aperture information into the camera.

Lens characteristics

Lens characteristics define lenses. Focal length, aperture and lens speed, and depth of field are characteristics that combine to influence the images you create.

Focal length

Focal length is the distance between the optical center of a lens and the focal plane (film plane) of the camera when the lens is focused at infinity. To understand this definition, you must fully understand the terms *focal plane*, *optical center*, and *infinity*.

- Focal plane -The surface or area at the back of the camera occupied by film on which images transmitted by a lens are brought into sharp focus.
 - Optical center -The optical center of a lens is a point, usually (although not always) within a lens, where light rays from two different sources entering the lens are assumed to cross.
 - Infinity -Infinity is a distance so far removed from the camera that the light rays may be regarded as parallel. Infinity is expressed by the symbol ∞ and is a setting on a camera focusing scale.
-

Continued on next page

Lenses, Continued

Focal length (Continued)

Figure 7-17 shows the focal length of a standard 50mm lens.

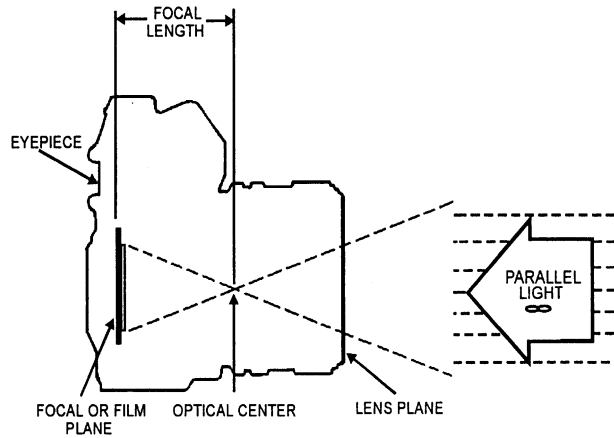

DMV30367

Figure 7-17.—The focal length of a standard lens.

Focal length, imprinted on the lens mount at the front of the lens barrel, is sometimes expressed in inches, sometimes in millimeters (mm), and occasionally in both systems.

Figure 7-18 shows a lens barrel with the imprinted focal length of the lens clearly visible.

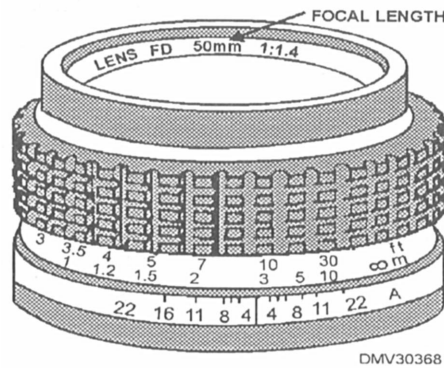

DMV30368

Figure 7-18.—A lens barrel showing the focal length designation.

Continued on next page

Lenses, Continued

Lens range Lens range refers to focal length, or the distance between the lens plane and the focal plane. Lens ranges may be fixed or variable. Fixed lenses have focal lengths that do not change. Lens ranges may be long, short, standard, or macro. Variable lenses have changeable focal lengths to zoom images closer or farther away.

Long-range lenses Long-range lenses are lenses with focal lengths greater than 58mm. Most long-focal-length lenses are called *telephoto* lenses. Use these lenses to draw images closer. Lenses ranging from 85mm to 105mm are used for portraiture because they create the most natural images of people, without excessive distortion. Ideal for action or sports photography, long-range lenses require more light and faster film than standard lenses.

Short-range lenses Short-range lenses are lenses with focal lengths less than 50mm. Short-range lenses include wide-angle lenses (less than 40mm in focal length), and ultra-wide-angle lenses, called *fisheye* lenses, with focal lengths of 17mm or less. Shorter focal-length lenses magnify features nearest the camera to the point of apparent distortion. Wide-angle lenses are indispensable for filming in confined spaces and panoramic views. Use a lens hood to shade wide-angle lenses from glare.

Standard-range lenses Standard-range lenses have focal lengths between 50mm and 58mm, with the most common focal length being 50mm. Standard-range lenses most closely record images as the human eye would see them. Distortion is negligible.

Macro lenses The most popular macro lenses have focal lengths of 50mm and 100mm. Use a macro lens for close-up photography such as copy work. With 100mm macro lenses, you do not have to get as close to the subject as with 50mm macro lenses. The extra distance 100mm macros provide is especially useful when taking pictures that present hazards. Macro lenses perform well and offer greater versatility when used as general-purpose lenses in routine shoots.

Continued on next page

Lenses, Continued

Variable lens Lenses with changeable focal lengths are called *variable* or *zoom* lenses. The photographer pulls, pushes, or twists a sleeve around the barrel of the lens. The aperture and focusing rings are coordinated and move in unison with the focal-length sleeve. This lens is indispensable when shooting in conditions that change too rapidly to manually change lenses.

Lens coverage Focal length is a determining factor in the coverage of the lens. The maximum image coverage at the focal plane of a lens is expressed in degrees and known as the *angle of field*. The angle of field is the widest angle at which light entering a lens produces a usable portion of illumination at the focal plane. Beyond the angle of field, light becomes less intense and image sharpness decreases. The angle of field is similar but not the same as the angle of view. The angle of view (also in degrees) is the amount of image coverage of a lens on the focal plane within a particular film size. The angle of view should not exceed the angle of field.

Figure 7-19 illustrates the different angles of view.

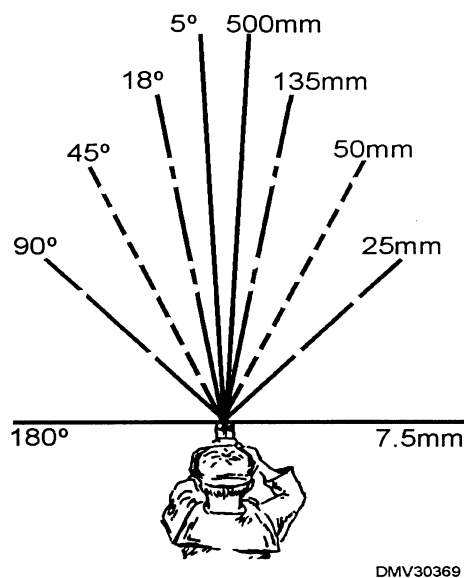

Figure 7-19.—Angles of view available with focal lengths shown.

Continued on next page

Lenses, Continued

Lens apertures Aperture openings are located on a ring or collar around the lens barrel. The size of the largest opening, called the maximum working aperture of the lens, is referred to as *lens speed*. Apertures also influence depth of field.

Depth of field Depth of field is the distance from the nearest point of acceptably sharp focus to the farthest point of acceptably sharp focus. Depth of field depends on the focal length of the lens, the f/stop setting, and the distance at which the lens is focused. Depth of field is greater with short-focal-length lenses than with long-focal-length lenses. As aperture decreases, depth of field increases. It is more important to focus accurately on nearby objects than for distance objects. When you want maximum depth of field, focus the lens on the hyperfocal distance or infinity for the f/stop used, not on the subject. To preview depth of field before exposure, depress the preview button or partially depress the shutter release to stop down the aperture. An estimate of depth of field is shown on the aperture ring on most cameras. The ring shows an approximate range for depth of field.

Figure 7-20 shows depth of field.

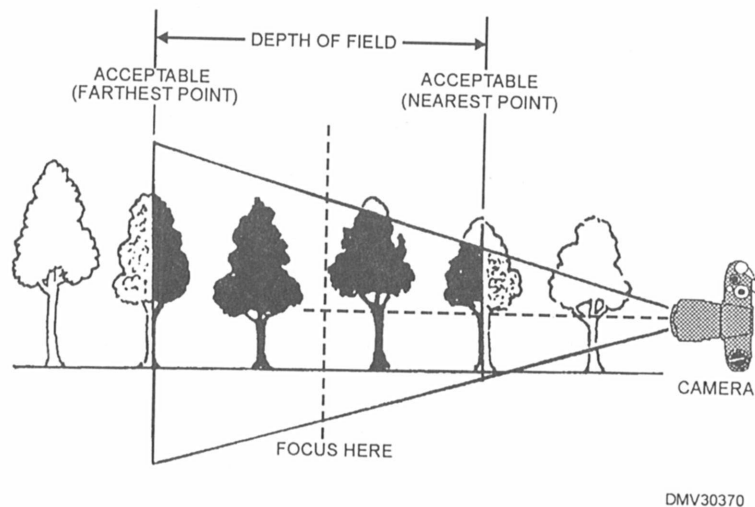

Figure 7-20.—Depth of field.

Continued on next page

Lenses, Continued

Depth of field (Continued)

Figure 7-21 shows the aperture set at $f/8$ on a standard lens. The depth of field when focused on a centered subject extends from just in front of the subject (at $2\frac{1}{2}$ feet) to just behind the subject (at $5\frac{1}{2}$ feet). At $f/16$, the depth of field increases to just over 2 feet to $10\frac{1}{2}$ feet.

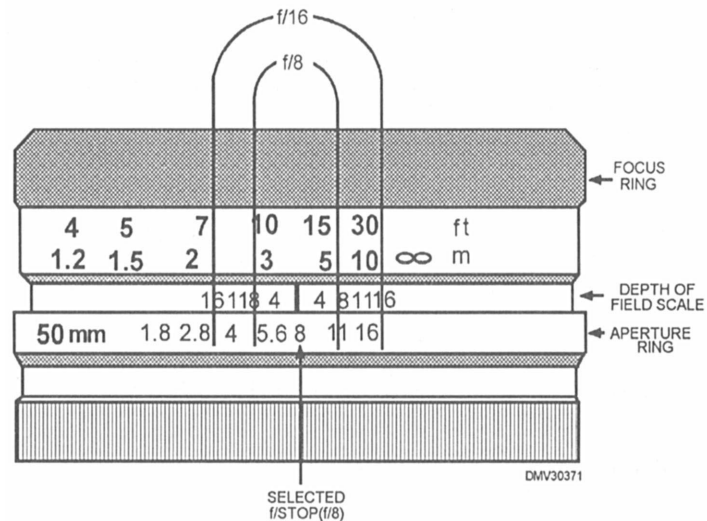

Figure 7-21.—Reading depth of field.

Use this table for guidance in increasing or decreasing depth of field.

| Decreasing depth of field | Increasing depth of field |
|-------------------------------------|--|
| Use a larger f/stop (lower number). | Use a small f/stop (higher number). |
| Use a longer focal-length lens. | Use a short-focal length lens. |
| Move closer to the subject. | Use a faster film or slower shutter speed or a smaller f/stop. |
| | Focus at the hyperfocal distance or infinity. |

Films

Introduction

Selection of an appropriate film requires knowledge of film characteristics, lighting situations, and potential compromises. There are many types of conventional films to choose from as well as video disks.

Film

Film is an emulsion of light-sensitive silver halide salts on a translucent or transparent acetate base. When struck by light, the emulsion hardens and deforms recording a latent or invisible image. Chemical additives in the emulsion determine the range or wavelength of light to which the film responds. The image visibly appears only after chemical development.

Black-and - white film composition

Black-and-white film is a light-sensitive emulsion on a transparent or opaque base used to photograph reversals (positive) or negative images. In addition to the emulsion and the base, there are three additional layers of substances that perform special functions. Overcoating, antihalation backing, and noncurl coating complete the five component parts of black-and-white photographic film.

EMULSION: The emulsion contains light-sensitive silver salts called silver *halides*. Silver halides react to ultraviolet (UV) radiation, violet, and blue light only. They can be made sensitive to other colors of light and infrared radiation (IR) by the addition of dyes. A gelatin evenly disperses the silver halides and dyes onto a base.

BASE: The film base holds or supports the emulsion.

OVERCOATING: Overcoating is a clear layer of gelatin that protects film from friction, scratches, or abrasion. The overcoating is sometimes called the antiabrasion layer.

ANTIHALATION BACKING: The antihalation backing prevents light from reflecting from the base back into the emulsion.

NONCURL COATING: The noncurl coating is a hardened gelatin applied to the back of the film that prevents the film from curling during the drying process.

Continued on next page

Films, Continued

Color film

Color film also consists of a light-sensitive emulsion on a transparent or opaque base used to record images. The main difference between color and black-and-white films is that color emulsion consists of three distinct layers. Each of the three layers of emulsion records one of the three additive primaries - red, green, or blue. Modern films have fast and slow emulsion layers for each primary color to improve film speed and resolution. Color films produce reversals (positive) or negative images.

COLOR REVERSALS: Color reversal films produce positive images in densities directly proportional to the objects in a scene. Reversal films contain the suffix “chrome” in their name. Development of color reversal films is a two-stage process. Developed color reversal film can be used as transparencies (slides) for direct viewing, printed directly onto color reversal paper, copied on black-and-white films for producing black-and-white prints, or copied onto color internegative (copy negative) for producing color prints.

COLOR NEGATIVES: Color negatives record scenes in image densities opposite to the brightness of objects in a scene. Most color negatives have an orange mask that increases color separations producing colors more accurately. Color negative films contain the suffix “color” in their name. Color negative images can be printed on color positive materials such as color-paper and color-print film to produce color prints or transparencies. Color negatives can also be printed on special panchromatic black-and-white paper to produce black-and-white prints.

Film format

The two basic film formats commonly used in the Navy are roll film and sheet film. Both formats come in a variety of sizes. Both film formats are available in black-and-white or color.

Roll film

Roll film is film packaged so that it may be loaded and unloaded from a camera in daylight. Number 120 roll film has a paper backing that prevents inadvertent exposure; 35mm film is wound in light-tight cassettes. The most common film size, 35mm, comes in prepackaged cassettes in lengths producing 12, 20, 24, and 36 exposures or frames per roll. Also, 35mm film comes in 100-foot rolls for bulk loading into reusable cassettes.

Continued on next page

Films, Continued

Sheet or cut film

Sheet or cut film is made in a variety of sizes from 4 by 5 to 11 by 14 inches and larger. Sheet film does not have a paper backing and must be loaded and removed from film holders in total darkness. Most sheet films have notches in one edge of the film to identify film type and emulsion side when in the dark. Emulsion to emulsion contact or emulsion toward the copy produces the sharpest images. The emulsion is toward you when the notches are on the top edge, upper-right corner of the film or the bottom right edge, lower-right corner of the film. For sheet films without notches, the emulsion side of the film can be identified by its lighter color when viewed under a safelight. If the emulsion side of the film must be identified in total darkness, wet your lips and place the edge of the film between them. The emulsion side of the film will stick to one of your moistened lips.

Video disks

Most electronic cameras use compact, 2-inch, still-video floppy disks to record images as magnetic impulses. Video disks do not contain emulsions or a base. The camera and the printer determine whether an image is black and white or color. Pictures are recorded in either the frame or field mode in the camera. The frame mode records each image on two tracks. Twenty-five images fit on one disk in the frame mode. In the field mode, each image records on one track so 50 images fit on one disk. The quality of frame-recorded images is superior to that of the field-recorded photograph. Floppy disks used in electronic imaging may be reused endlessly. No chemicals or darkroom techniques are required. Once captured on disk, an image can be transmitted over telephone lines, edited, and printed - all under normal room light.

Film characteristics

Film characteristics are determined by the film's degree of sensitivity to light, response to various colors of light (color or spectral sensitivity), contrast, exposure latitude, emulsion latitude, and emulsion definition. The characteristics and use of black-and-white films depend largely on the construction of the emulsion.

Emulsion sensitivity

Film emulsions are very sensitive to low levels of light. The light causes invisible changes to the emulsion. These changes or images are called *latent images*. Latent images become visible after chemical development. The property of a film emulsion to respond to light is termed *film speed*.

Continued on next page

Films, Continued

Film speed

Film speed indicates the ability of the film emulsion to record latent images. The International Standards Organization (ISO), a federation of all the national standard bodies of the world, uses a uniform set of film speed standards to rate film. This is referred to as an ISO number. This ISO number generally looks like the following: ISO/21°. The ISO number assigned to the film is displayed on the film canister, packing material, and exterior packaging. Lower ISO numbers indicate slow films, while high ISO numbers indicate faster films.

FAST FILMS: Films considered “fast” is film that requires little light for correct exposure. These low-light film speeds have ISOs of 400 and higher. Image resolution is good in small prints; however, pronounced graininess appears in enlargements. Some of the very fast films, ISO/1000° and faster, need very little light and extremely short exposure times. Fast films are difficult to handle in bright light situations but highly desirable for dimly lit subjects.

SLOW FILMS: Slow films require more light or longer exposures to record images. Slow films, such as ISO/25°, display very fine grain that remains fine even in enlargements. These films are ideal in controlled studio environments.

Spectral sensitivity

The response of an emulsion to specific colors of light or radiant energy is termed *color* or *spectral sensitivity* including ultraviolet and infrared radiation as well as visible light. Color sensitivity in black-and-white films controls the way colored objects record as tones of grey in the negative or print. Color sensitivity determines how a film is classified into the four general categories of monochromatic (colorblind), orthochromatic, panchromatic, and infrared.

MONOCHROMATIC (COLORBLIND) EMULSIONS: Monochromatic emulsions are sensitive only to UV radiation, violet, and blue light. Used for copying and graphic arts continuous-tone and line (halftone) photography, monochromatic films may be assigned three or more ISO values; for example, ISO/50° for daylight, ISO/8° for tungsten light, ISO/20° for white-flame arcs, and ISO/12° for pulsed xenon lighting. The ISO value you use depends upon the lighting system of your copy or process camera.

Continued on next page

Films, Continued

Spectral sensitivity (Continued)

ORTHOCHROMATIC: Orthochromatic films are sensitive to ultraviolet radiation, violet, blue, and green light. The emulsion provides approximately correct reproductions of blue and green objects in corresponding tones of grey in daylight or tungsten light. Used primarily for copy work and graphic arts photography, orthochromatic film trade names usually contain the word “ortho.” Ortho-type films may be used as continuous-tone or halftone (line) film.

PANCHROMATIC: Panchromatic films are sensitive to UV radiation, violet, blue, green, and red light. Panchromatic films are used for copy work, portraiture, and general photography. These films have only one ISO speed.

INFRARED: Infrared film emulsions are sensitive to UV radiation, violet, and blue light, with little sensitivity toward yellow-green light. Sensitivity to red and infrared light is heightened. Infrared film is used for aerial and medical photography. Since infrared radiation does not focus at the same point as visible light, a lens focus adjustment is necessary for critical focusing. Most lenses have a calibrated IR-focusing position on the depth-of-field scale marked by a small dot or the letter “R” in red.

Figure 7-22 shows the calibrated focus adjustment required to compensate for infrared film.

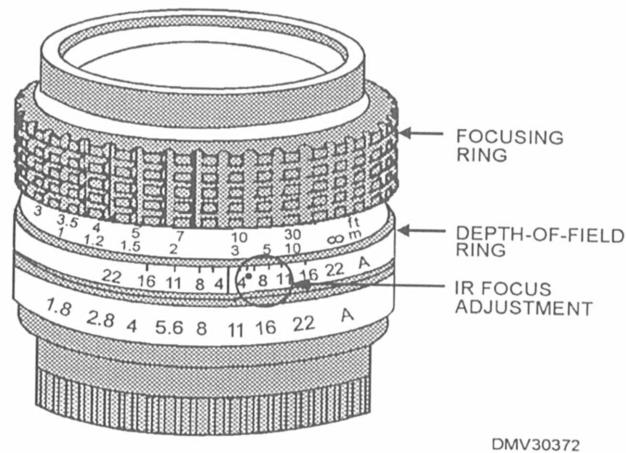

Figure 7-22.—The calibrated focus adjustment indicator for infrared films.

Continued on next page

Films, Continued

Film contrast Film contrast is the difference in density between areas in negatives. After development, grains of silver halides remain in film but are redistributed to create tonal areas of grey. These grey areas range from very dense to very thin, depending on the brightness of the objects in the scene. The portions of negatives where the most silver halides are affected are referred to as *highlights*. The portions that are least affected are called *shadows*. Light reflections from objects other than the brightest and the darkest are referred to as *midtone*s. The amount of metallic silver deposited in any portion of a negative is referred to as *density*. Density describes the light-stopping ability of a negative.

Film emulsion latitude Emulsion latitude is the ability of a film to record a range of scene brightness differences as density differences. Normal- and low-contrast emulsions record a wide range of brightness. High-contrast films record a short range of brightnesses and are considered to have a narrow latitude.

Film exposure latitude Exposure latitude is the amount of departure (increase or decrease) from the ideal exposure setting the film will allow while still producing negatives of acceptable contrast.

Film emulsion definition Emulsion definition is the ability of films to produce clear, sharp images. Emulsion definition includes graininess, resolving power (resolution), and acutance (the ability to produce sharp edges).

GRAININESS: Graininess is a speckled, mottled, or granular appearance on the surface of negatives that is magnified in prints. The amount of apparent grain depends on the size of silver halides, the exposure the film received, and the clumping of the silver grains during development. Extreme graininess is called *reticulation* and may be used creatively to add interest to a layout.

RESOLUTION: Resolution is the ability of films to record fine detail. The resolution or resolving power is expressed as line pairs per millimeter. As negatives are enlarged, resolution lessens and grain increases. This softening of the image becomes most apparent when cropping 35mm negatives and enlarging them in print.

Continued on next page

Films, Continued

Film emulsion definition (Continued) ACUTANCE: Acutance is the objective measure of the ability of photographic material to show a sharp linear demarcation between contiguous areas receiving low and high levels of exposure to light.

Color film balance Color film balance is the acceptable relationship among the three color primaries in positive color prints or slides. In other words, if the color appears correct, the color is visually balanced. Color films are referred to as daylight (outdoor) or tungsten (indoor) film indicating their broad use without filters. Daylight film is specifically balanced for use in sunlight or with electronic flash. Tungsten films are balanced for use with artificial illumination from camera or copystand lights. Using the wrong color balance film will make slides and prints appear off-color.

Film handling Handle film only by the film edges to minimize fingerprints and the build-up of static electricity, which appear on prints as white (undeveloped) areas. Keep film in its protective package or canister until needed. Protect film surfaces from dust, lint, fingerprints, abrasions, and scratches.

Film date expiration Films are manufactured to provide optimum color balance when purchased. That is when a film is said to be fresh. Film emulsions are made up of many different chemicals that deteriorate slowly over time. From the day of manufacture, all films begin to change; and as films age, film characteristics change. Manufacturers mark expiration dates on film packaging to indicate when film is no longer fresh. Film is intended for prompt processing to prevent any significant shift in color balance before development.

Film storage Store film as a first-in first-out product and refrigerate, if possible. Use film with near expiration dates first. Refrigeration keeps film near the optimum color balance, retarding deterioration, until used. Remove film from refrigeration approximately 90 minutes before loading into a camera. Allowing films to attain room temperature will prevent brittleness and cracking. It will also prevent condensation from forming on film surfaces that may fog pictures taken before the film has a chance to warm.

Papers

Introduction

Papers, like films, have different characteristics. Some basic knowledge and common sense regarding the handling of light-sensitive papers will make your darkroom experiences less frustrating.

Black-and-white paper emulsion

Black-and-white papers consist of emulsion on a paper base. Images on black-and-white films are usually negative or recorded in tones of grey in reverse of the reflective brightness of a scene. Projecting negative images onto black-and-white papers results in positive images recorded in tones of grey relative to the reflective brightness values in the original scene.

Color paper emulsion

Color papers consist of a three-layered emulsion on a paper base. Color printing papers are for printing color negatives or color transparencies. Like color films, color printing papers can be identified by the suffixes “color” for color prints and “chrome” for color transparencies.

Paper format

Photographic printing papers (both in black-and-white and color) are manufactured in various cut-sheet sizes ranging from 5 by 7 to 20 by 24 inches and rolls up to 1,000 feet long.

Paper characteristics

Paper characteristics are similar to film characteristics and these characteristics are emulsion sensitivity, spectral sensitivity, contrast, and paper surfaces. The performance and use of photographic printing papers depend on the characteristics of the paper.

Paper emulsion sensitivity

Paper emulsion sensitivity refers to the responsiveness of a paper to light. The emulsions used for printing papers are slower or less sensitive to light than most film emulsions. A high sensitivity to light is not required or desirable. Slower paper emulsion sensitivity allows for some exposure manipulation during the printing process to correct incorrectly exposed negatives. Exposure manipulation that results in more light given to an area is called *burning in*. *Dodging* is the term used when light is selectively shielded from specific areas on the paper during exposure.

Continued on next page

Papers, Continued

Paper spectral (color) sensitivity Paper spectral sensitivity is the ability of a paper to respond to specific colors of light. The terms *monochromatic* (colorblind), *orthochromatic*, and *panchromatic*, used to describe the spectral sensitivity of films, also apply to photographic papers. In selecting black-and-white papers for printing, spectral sensitivity is not a factor. Black-and-white papers may be handled in the darkroom under a (manufacturer-recommended) soft light called a *safelight*. In selecting color-print papers, spectral sensitivity determines whether or not to use a safelight and what color safelight to use.

Paper contrast Paper contrast is the ability of a paper to produce images that replicate the highlights, shadows, and midtones found in the original scene. Navy imaging facilities and graphic shops use papers called *variable-contrast* papers. These papers have two emulsion layers, a high-contrast layer and a low-contrast layer, that make achieving the correct contrast in prints easier.

Paper surface Paper surface refers to the physical texture of paper and the coating on the surface of paper. Photographic papers are available in a wide variety of paper surfaces, such as matt, semimatt, lustre, high lustre, pearl, and glossy. Textured papers that resemble canvas, linen, and brush strokes are also available. The most common papers in graphics shops are glossy and matt.

GLOSSY: Papers that have smooth glossy surfaces provide prints with high contrast and high-density color saturations, resulting in apparently sharper images. This occurs because glossy papers reflect light directly. Glossy papers are used for photographic prints that must show fine details, such as equipment damage, intelligence photos, or small photographs of cluttered scenes.

MATT: Light reflected from matt papers is diffused, providing softer, lower contrast in the images. Details do not appear sharp. Matt-surfaced papers are commonly used in portraiture and expansive scenes.

The surfaces of papers used by the Navy are coated with either polyethylene or resin. Papers are coated on both sides of the base. This clear coating protects papers from abrasion and from sticking to each other during the processing procedure. You may write on polyethylene papers with pencils, pens, or markers. Resin-coated (RC) papers require you to use markers with special inks that adhere to slick RC surfaces.

Continued on next page

Papers, Continued

Paper handling When handling photographic papers, take care not to leave fingerprints, abrasions, or scratches on paper surfaces. Handle photographic papers only by their edges. Prevent unnecessary contact with the emulsion side of papers. Protect papers from dust and lint by leaving the paper in its protective packaging until needed.

Paper expiration Paper emulsions, like any light-sensitive materials, should be exposed and printed before they pass the manufacturer's recommended expiration date. Use papers on a first-in first-out basis. Leave papers in their packages until needed. Papers stored in unfavorable conditions or that have expired may have a loss of emulsion speed, undesirable contrast changes, stains, color shifts, or high gross or intense fog.

Paper storage Store paper packages in a refrigerator, if possible. Papers are packaged in humidity-sealed boxes to protect papers from relative humidity (RH). When the RH exceeds 60 percent, packages, labels, and emulsions become damaged by molds and fungi. Do not store foods or liquids in the same refrigerator as films and papers because they raise the relative humidity of the refrigerator. After removing photographic paper packages from the refrigerator, allow them to warm to room temperature before use. This warm-up period should be from 10 hours to overnight. Papers used before they have sufficiently warmed to room temperature may be difficult to process or exhibit high gross fog.

Finished Prints

Introduction You may not need to use the entire image in a photograph. You should know how to select portions of or scale photographs inside and outside the darkroom.

Cropping Cropping is the procedure of defining a desired image area within a larger image area. Crop photographs when the original image contains more information than desired and select a specific portion of the image to enhance the finished print. Photographs may be cropped in the darkroom or outside of the darkroom.

Cropping in the darkroom To crop photographs in the darkroom requires a negative. The negative is necessary to project and enlarge the image before exposure to paper. Place the negative in the enlarger and raise the enlarger head until the selected portion of the image appears in the desired size on the print frame. Turn off the light in the enlarger, place the print paper in the print frame, and expose. The developed print will be cropped as you desired. One of the advantages of cropping in the darkroom is less paper waste. A disadvantage of cropping in the darkroom is that by increasing the image in the enlarger, grain also increases in the print and lessens resolution.

Cropping outside of the darkroom If you have been given prints to work with instead of negatives, you may have to crop images outside of the darkroom. A simple method of cropping involves two pieces of white cardstock, each cut in an “L” shape. By maneuvering these two pieces of angled paper, called *cropping arms*, you may frame the desired portion of the image in many ways. If possible, mount photographs on cardstock. Place the cropping arms on the image and move them until you have framed the desired portion. Indicate crop marks on the cardstock border.

Indicating crop marks Indicate crop marks on photographs by lightly marking the borders around the photograph, marking an overlay attached to the print, or cutting a window in opaque masking paper to expose the desired portion of the print. If you must mark on photographs, use a grease pencil so that the marks may be easily removed. Do not mark more than one set of crop marks on an image.

Continued on next page

Finishing Prints, Continued

Scaling artwork Scaling is a term used for calculating dimensions for the reduction or enlargement of an entire given image. The entire image is proportionately enlarged or reduced. The most common methods of scaling outside of a darkroom are the diagonal line method and the scaling wheel, which is often called a *proportional scale*.

Scaling images in the darkroom If you have a negative to print images from, scaling is easily accomplished in the darkroom as part of the projection and exposure process. It is simply a matter of selecting the finished size of the print and projecting the image to that size on the print frame before exposure. An advantage of scaling images in the darkroom is that grain and resolution enlarges or reduces proportionately. The disadvantage is not seeing the final scaled image before developing the print.

Scaling images outside of the darkroom The diagonal line method and the proportional scale are used for scaling hard-copy images outside of the darkroom. Detailed explanations of both methods are found in DM Volume 4, chapter 1. If possible, you should mount the photograph to a solid backing, such as a piece of cardstock. An advantage in scaling artwork from prints is that as images are reduced, so are details. A disadvantage is that flaws are magnified in enlargements.

Marking enlargement or reduction on a print Indicate the enlargement or reduction of images on the border around a print or on an overlay on the photograph. Enlargements and reductions may be indicated in percentages or in ratios.

Figure 7-23 illustrates examples of scaling percentages and ratios.

50% REDUCE
10% ENLARGE

A. PERCENTAGES

2:1 (REDUCTION)
1:2 (ENLARGEMENT)

B. RATIOS

DMV30373

Figure 7-23.—Indicating scale: A. Percentages; B, Ratios.

Summary

Review

This chapter covers the operation and maintenance of process, copy, and small-format cameras. Lens descriptions are given to aid in the appropriate selection of lenses to maximize lens capabilities. Understanding lens speed and range gives you advantages that make your photographic experiences easier. Text on shutter speeds and apertures provides you with a fundamental understanding of how and why films record light as they do. Films and papers may be the end product or just a transitional step in a complicated creative process.

Comments

Photography is an integral part of graphic arts. The fundamentals of photography and the theory of light do not change, but technology surrounding the equipment and consumables changes regularly. Recent technological changes rapidly infiltrating the industry are chemical-free electronic and digital imagery. The impact of these changes in the graphic arts world is great. Stay abreast of changes.

CHAPTER 8

COMPUTER GENERATION

Overview

Introduction Breakthroughs are being made in the graphic arts world through the use of computers. New wave imagery is replacing tired cliches. This innovative art world captivates our imagination with fantastic images that look surrealistic. Computer imagery or enhancement is rapidly becoming the norm in Navy graphics shops and presentations departments.

- Objectives** The material in this chapter enables you to do the following:
- Identify software and assign and protect classified data contained on disks.
 - Identify computer viruses.
 - Differentiate between common software features, options, and commands.
 - Evaluate the differences between directories and subdirectories.
 - Identify the steps needed to convert conventionally conceived images to digital imagery.
 - Create, modify, save, and retrieve tags in desktop publishing software.
 - Create, modify, save, and retrieve frames.
 - Create, modify, save, and retrieve style sheets.
 - Modify text attributes.
 - Create, modify, save, and retrieve web pages.
-

Continued on next page

Overview, Continued

Acronyms

The following table contains a list of acronyms that you must know to understand the material in this chapter.

| Acronym | Meaning |
|-------------|--|
| ASCII | American Standard Code for Information Interchange |
| Bit | Binary Digit |
| CPU | Central Processing Unit |
| CRT | Cathode-Ray Tube |
| CYMK | Cyan, Yellow, Magenta, and Black |
| DPI | Dots Per Inch |
| DTP | Desktop Publishing |
| E-mail | Electronic Mail |
| EMR | Electra-Magnetic Radiation |
| EPS or EPSF | Encapsulated Postscript Format |
| FAQ | Frequently Asked Questions |
| GB | Gigabyte |
| GIF | Graphic Images Format |
| GUI | Graphical User Interface |
| HTML | Hypertext Mark-up Language |
| http | Hypertext Transfer Protocol |
| JPEG or JPG | Joint Photographic Experts Group |
| KB | Kilobyte |
| LPI | Lines Per Inch |

Continued on next page

Overview, Continued

Acronyms (Continued)

| Acronym | Meaning |
|---------|------------------------------|
| | |
| PC | Personal Computer |
| PDF | Portable Document File |
| RAM | Random Access Memory |
| RGB | Red, Green, Blue |
| RIFF | Raster Image File Format |
| RIP | Raster Image Processor |
| ROM | Read-Only Memory |
| SYSOP | System Operator |
| SVGA | Super Video Graphics Array |
| TIFF | Tag Image File Format |
| TSR | Terminate-and-Stay Residents |
| VGA | Video Graphics Array |
| WYSIWYG | What You See Is What You Get |
| WWW | World Wide Web |

Continued on next page

Overview, Continued

In this chapter

This chapter covers the following topics:

| Topic | See Page |
|--------------------------------|-----------------|
| Software | 8-5 |
| Viruses | 8-12 |
| Common Software Features | 8-14 |
| Common Software Options | 8-24 |
| Common Software Commands | 8-26 |
| Directories and Subdirectories | 8-30 |
| File Formats | 8-34 |
| Word Processing Software | 8-37 |
| Graphics Software | 8-38 |
| Desktop Publishing Software | 8-51 |
| Web Pages | 8-53 |

Software

Introduction

Computers can do nothing without a set of instructions the system operator inputs to the central processing unit. These instructions allow the computer to perform many functions including sorting, saving, and processing information with remarkable speed. Review *Illustrator Draftsman (DM)* Volume 1, chapter 3, or read NEETS Module 22, *Introduction to Digital Computers*, before studying this chapter to familiarize yourself with computer hardware systems.

Software

Software is the set of instructions, program parameters, or data. Hard drives and floppy disks are hardware; the data on the disk is software. The two categories of software are operating system software and applications software.

Operating systems software

Operating systems software manages the operation of the entire computer system. Its primary job is managing the system and system resources such as the disks, the printers, and the modems. Operating system software links computer hardware to applications software. Operating systems software exists primarily in read-only memory (ROM).

Installing operating systems software

Install operating system software onto the system hard disk drive before attempting to load applications programs. Follow the manufacturer's owner/user manual. The owner/user manual will tell you setup commands that lead you through the installation process from the display screen. The display screen prompts you to enter the appropriate keystrokes or mouse movements to place the software into the hard drive. Once you have operating system software installed, put the original distribution disks or CD ROM disks in a safe place. You may need the original operating system software distribution disks later.

Applications software

Applications or user software are program disks that help you accomplish specific tasks. Distribution disks for applications software require information about the microcomputer configuration or what devices make up the computer system. Applications software is created using WORM (Write Once/Read Many) technology and stores in ROM. This allows you to use the program without altering the original program's instructions.

Continued on next page

Software, Continued

Installing applications software

Before installing applications software, make sure the operating system software is properly installed. Applications software won't install if there are problems with the operating system. Refer to the manufacturer's owner/user manual before installation to determine if the memory requirements of the program exceeds your hard drive capacity. Once you install applications software, put the original distribution disks in a safe place.

Using software wisely

To use software wisely, familiarize yourself with the capabilities and limitations of each software program and consciously develop good, systematic approaches in your work habits. The following list contains several smart work habits to develop that help you avoid common problems.

- Define document parameters before entering images or text. Defining document parameters allows applications software to paginate the document. Pagination includes setting the margins, page numbering, and selecting text attributes before entering the data into the document. Pagination saves the extra effort required to rearrange pages later. Once set, the computer memory retains the format settings and applies it to each page of the document without further prompting.
 - If the software allows, display reveal codes (codes indicating selected functions) on the screen as you work by selecting this option from VIEW. This process allows you to see any coding errors made during the creation of the document. Not every software program displays reveal codes.
 - Eliminate unused codes. If you are able to display reveal codes on the screen, remove erroneous or unused codes. Maintain only required coding in documents to make it easier to edit or modify text later. Unused or incorrect coding in documents affects the amount of control you have over the finished product.
 - Do not use the SPACE bar to position text. Set tabs to indent text into documents. This procedure allows you to maintain control of the text if you must modify it later.
-

Continued on next page

Software, Continued

Using software wisely (Continued)

- Break the habit of hitting the ENTER or RETURN key to move the cursor to the left margin before completing a line of text. Using this key unnecessarily enters a hard return into the coding of the document. As you enter text, the cursor automatically returns to the left margin when the line of text fills. This feature, called *word wrap*, enters a soft return vice a hard return into the document.
- Hit the SAVE option periodically. Although most computers have a timed back-up feature, this is a crash-protection feature only that saves data if you turn off the machine or close the document before saving it properly. Make it a habit to save data whenever you must look away from the document to answer the phone, hold a conversation, or look up reference material. Habitually saving material, in addition to the timed backup feature, lessens data loss should unforeseen circumstances cause the computer to crash, freeze, or lock up.
- Use working copy disks. Using working copy disks saves memory space, and facilitates safeguarding and protection of classified or sensitive material. If the computer develops a virus or loses data during power fluctuations, the damages would be recoverable.
- Make back-up disks. At the end of the work day and even if you save data on the hard drive, make a back-up disk. This disk may save you hours of work if your hard drive crashes and you must swap out hard drives.
- Label disks. Label disks when created with the correct security marking and file names. This prevents inadvertently using disks that have data already stored, mixing classification levels, or misplacing data by mixing unlabeled used disks with unused disks.
- Select file names that can be identified by another SYSOP. Refer to the *Department of the Navy, Standard Subject Identification Codes* in SECNAVINST 5210.11 for the five sections and 13 major subject groups used in Navy graphics shops. Select file names that identify or easily cross reference to information on the disk.

Continued on next page

Software, Continued

Using software wisely (Continued)

In sea-going environments, secure computer hardware to desks or tabletops to prevent damage from heavy rolls and pitching during high sea states.' Excessive movement of CPUs may cause Video Graphics Array (VGA) cards and SVGA (Super Video Graphics Array) cards to loosen causing the color balance of monitors to shift or blink erratically. A drop from a height of approximately 3 feet (desk height) may cause substantial and irreparable damage to hardware.

Keep liquids and foodstuffs away from computer equipment. Place drinks and food below the keyboard or on another surface to prevent accidental spills and debris from ruining equipment.

Software or disk security

Often the data on disks is classified or sensitive to national security. Graphics and text created electronically and stored on disks require protection. The procedures for protecting and marking disks, disks drives, and work stations differ slightly from the procedures for marking graphics, photographs, and documents. Security procedures for electronic data are found in the *Department of the Navy, Automated Data Processing Security Manual*, OPNAVINST 5239.1.

Security

The three levels of data processed electronically are Level I, Level II, and Level III. If your command processes Level I and/or Level II data, it must provide a specific degree of protection. The following table defines the 3 levels of data:

| Level | Meaning |
|-----------|--|
| Level I | Classified; Confidential, Secret, and Top Secret |
| Level II | Unclassified; requires special protection, such as For Official Use Only and data covered by the Privacy Act of 1974 |
| Level III | Unclassified |

Continued on next page

Software, Continued

Level I

Level I data (classified) handling requirements and procedures are similar to those for handling hard copy classified material. You are responsible for safeguarding this information at all times. Within Level I, the four modes of secure electronic processing of classified data are *system high*, *dedicated*, *multilevel*, and *controlled* mode. The following table specifically defines the four security modes:

| Mode | Definition |
|-------------|--|
| System high | All computers on the network and connected peripherals protect data according to the requirements for the highest classification category and type of material contained in the system. System high requires a security clearance but not necessarily a need-to-know for all material in the system. |
| Dedicated | Specific users or a group of users with a security clearance and a need-to-know for the processing of a particular type of classified material exclusively use and control all of the computers and peripherals on a system. |
| Multilevel | Various types and categories of classified material stored and processed concurrently in a computer system that permits selective access to material by unclassified users and users with differing security clearances and need-to-know. This is a function of the operating system and associated system software. |
| Controlled | A computer system in which at least some users with access to the system have neither a security clearance nor a need-to-know for all classified material in the system. |

Continued on next page

Software, Continued

Level II Level II data is unclassified data that requires special protection. To assure protection for processing Level II data, the Navy established the limited automated information system access security mode. A system or network operating in the limited access security mode restricts the access to data only to individuals who by their job function have a need to access the information.

Level III Level III does not require the safeguards of Level I or Level II data. It does however, require proper handling to make sure that data is not lost or destroyed.

Electronic media security Computer systems and their associated peripherals require control and safeguarding at all times. This protection includes the disks, diskettes, disk drives, monitors, printer ribbons, and generated hard copies. In general, the two types of electronic media are *working copy media* and *finished media*.

WORKING COPY MEDIA: Working copy media is temporary information. It stays within the confines and control of your activity. After creating a working copy, retain it for 180 days before destruction. Examples of working copy media are information used and updated at frequent intervals.

FINISHED MEDIA: Finished media is permanent information. It can be released to other commands and activities. Finished media contains information that does not change or is pertinent for more than 180 days.

Security controls Date and mark classified electronic media when you create it. Assign disks classified Secret or Top Secret a sequential identification number to make tracking them easier. Control electronic media in the same manner prescribed for classified material. Protect electronic media according to the highest classification ever recorded on the disk. For media classified Top Secret or Secret, maintain a master list including the overall security classification and the identification number permanently assigned to the disk.

Continued on next page

Software, Continued

Disk security markings

To avoid confusion, set aside groups of disks for recording classified data at each security level. Mark each disk or diskette with stick-on labels identifying the overall security classification and permanently assigned identification numbers. When you declassify and degauss disks, remove all external labels indicating the classification unless you immediately use the disks to store information of the same classification level.

Figure 8-1 shows how the different levels of classification should be clearly marked on the exterior labels of disks.

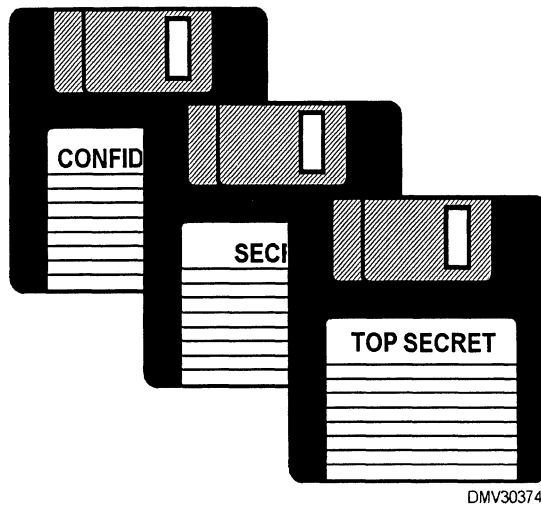

Figure 8-1.—Classification markings clearly marked on disk labels.

Media disposition

Magnetic media, such as disks, eventually wear out or become damaged. If disks contain classified material, degauss or erase them before destruction. Handle and dispose of printer ribbons and carbon papers used to print/transfer classified information according to the highest classification level of the data printed by that ribbon or carbon. Follow the requirements and instructions outlined in the *Department of the Navy, Information and Personnel Security Program Regulation, OPNAVINST 5510.1*.

Viruses

Introduction

Just as humans are infected by ingested viral agents, so, too, are computers vulnerable to suspect data entered into the CPU. Suspect data is referred to as viruses. Left untreated, viruses seek and destroy data and may cause eventual collapse of the infected computer system.

Viruses

Viruses are data parasites written and released into programs with the intention of creating mahem. These parasites seek data stored in hardware and software (hosts) to infect or destroy. Some viruses infect every file, others infect only applications software, data files, or operating system software. Viruses duplicate and reproduce themselves into legitimate files and may spread rapidly or sit in the system for months before attacking. Viruses may activate when you initially start or boot up the computer or immediately upon entering the system.

Virus transmission

Copying or erasing infected floppy disks, downloading data from infected computer bulletin boards, or accessing programs or networks via modems are all ways of acquiring viruses.

Virus identification

Sudden and unexplained pictures or messages appearing on the monitor screen or the disappearance of programs and data may indicate the presence of viruses. Investigate any unusual behavior in computer performance. New viruses appear regularly and may take any shape or form.

Virus elimination

Antivirus programs are software programs designed to detect and eliminate viruses. Some antivirus programs require activation each time you want the program to seek and destroy viruses. Other antivirus programs, called “terminate-and-stay resident (TSR)” programs, remain in ROM automatically activating each time you boot up or insert disks into the computer. Installing TSRs into the hard drive of the computer may interfere with software programs already in memory. If this happens, removing the antivirus program should return the software to normal.

Continued on next page

Viruses, Continued

Virus protection

To prevent or reduce exposure to computer viruses, take the following precautions:

- Use only commercially available disks.
- Avoid exchanging disks with another SYSOP.
- Limit the number of computers your computer contacts (via modem or floppy disk exchange).
- Back up your disks regularly as you work to minimize the amount of data lost should you contract a virus.
- Write-protect disks whenever possible. The write-protect feature locks up disks preventing inadvertent changes by virus infection.
- Use antivirus programs regularly and when borrowing disks from other computer users.
- Scan the hard drive weekly and create infection-free back-up disks.

Is it important to guard against viruses, to find and destroy viruses, and to disinfect any disk that may be infected also. Simple precautions minimize virus infections. Viruses are easier to prevent than to isolate and treat.

As good as antivirus programs are, they require updating to stay abreast of new viruses. The fear of virus infections should not cripple your interaction with computers and software so long as you invest in good antivirus software and use precautions.

Common Software Features

Introduction

The variety of software programs used by the Department of Defense and the U. S. Navy make it impractical to discuss each program and undesirable to select only one program for inclusion in this chapter. There are, however, several features and options common to a majority of software programs. There is no attempt to identify individual programs in this section. Your software may or may not have any of these features.

Cursors and pointers

Cursors and pointers indicate a current position on the screen. Common cursors are blinking horizontal or vertical bars and are usually moved by the keyboard or mouse. Pointers are usually associated with the mouse and appear as arrowheads, trailing arrowheads, crosshairs, hourglasses, I-beams, prohibiting circles, hands, and sometimes bars and cross hairs with directional arrows.

Figure 8-2 shows a variety of common cursers and pointers.



Figure 8-2.—Common cursers and pointers.

BLINKING BAR: A blinking, heavy-weighted bar usually precedes text. Its place is to the left of the next character. A mouse (rapid action input device) pointer may also appear on the screen, but as a non-blinking I-beam. The I-beam moves as the mouse moves. The blinking bar moves by operating the keyboard, cursor control keys, or by repositioning the bar with the mouse and clicking to anchor it in place.

ARROWHEADS and TRAILING ARROWHEADS: Arrowheads appear when you use a mouse to move around the screen in graphics software programs. The tip of the arrowhead must touch the section or item you intend to alter. If the image of the arrowhead tail lingers, it is said to be trailing.

CROSSHAIRS: Crosshairs representing the cursor or pointer appear when using the draw feature of graphics programs or desktop publishing programs. Crosshairs allow more precise positioning by focusing on a picture element (pixel).

Continued on next page

Common Software Features, Continued

Cursors and pointers (Continued)

HOURGLASSES: The appearance of an hourglass on the monitor screen indicates that the computer is accessing memory or a function. While the hourglass is displayed, the keyboard or mouse is inoperable. Hourglasses with an arrow indicate the computer is working, but you are free to access another function. The hourglass or hourglass with arrow disappears when the computer completes the requested activity.

DIRECTIONAL ARROWS on bars or cross hairs: Directional arrows attached to bars or cross hairs indicate that the cursor may shift selected items or lines in the direction of the arrows to another position in documents. Directional arrows also allow you to resize information windows.

PROHIBITING CIRCLES: Circles crossed diagonally by a line that may or may not have an additional icon let you know that the application or function you request is prohibited.

HANDS: Hands or question marks indicate that clicking in a particular space, phrase, or image accesses the HELP feature of the software program. On the Internet or web pages, these helpers indicate internal and external links to web sites.

Icons

Icons are small graphic images representing functions or applications of software. Icons eliminate memorizing multiple keystrokes by replacing the keystrokes with pictures. Icons speed up selection and execution of options. The ability of software to use graphics to make software more user friendly is part of the software graphical user interface (GUI).

Screen displays

Screen displays are the entire monitor face capable of showing information. Some screens show only a portion of text requiring the viewer to scroll. Screens that show a portion of the whole image are difficult to work with and make it hard to develop a feel for page aesthetics. Monitors having more pixels and larger working monitors may allow you to see exactly how pages will appear when printed. Monitor resolution is adjustable. On-screen information appears and disappears through what are called windows.

Continued on next page

Common Software Features, Continued

Windows

Windows are enclosed areas on the screen and are called application windows. Within the application window, other open windows display the file that is currently open, the features available to change the file, the software tools to change the file, and the file itself. Clicking into features and options opens windows that contain all the information required to access software applications. Multiple windows can appear side-by-side, made smaller or larger, or be temporarily placed elsewhere on the screen until required.

Program and file name

A window called a *title bar*, usually located across the top of the screen, displays the name of the software program and the particular file currently open. Preceding the file name is a designator indicating which drive or disk the file is on.

Figure 8-3 shows a program and file name (volume 3, chapter 8) in the hard drive (C:) in a window at the top of a screen.

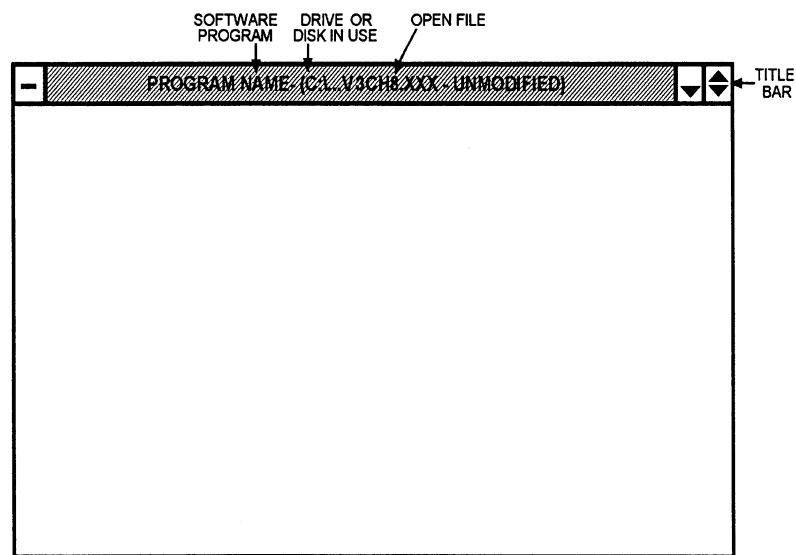

DMV30376

Figure 8-3.—The onscreen title bar.

Continued on next page

Common Software Features, Continued

Minimize and maximize

Minimizing windows reduces the image to a preset smaller size. Maximizing windows fills the screen monitor with the document image and may make menus and toolbars disappear altogether.

Figure 8-4 shows the position of the minimize and maximize features.

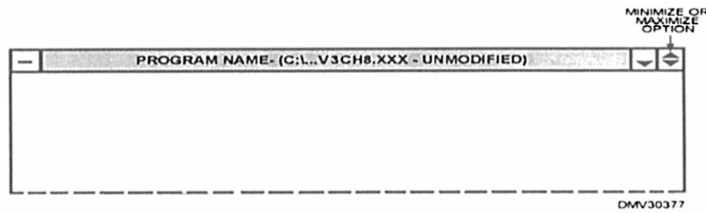

Figure 8-4.—Locating the minimize/maximize options on a windows 3.X program.

Close or exit

To close or exit a program, click the mouse on the minus (-) or (x) symbol in the window displaying the software and file name. This feature closes the program quickly.

Menus

Menus are lists of features that appear at the top or the side of the monitor screen. These features control document parameters. Common features are FILE, EDIT, VIEW, INSERT, FORMAT, TABLE, GRAPHICS, TOOLS, WINDOW, and HELP.

Figure 8-5 shows how menus may appear in the window across the top of monitor screens.

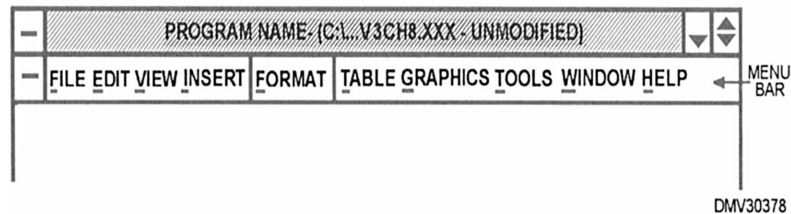

Figure 8-5.—Menus.

Continued on next page

Common Software Features, Continued

Menus (Continued)

Clicking the mouse on menu features reveal document parameter options available to you. This list of options is called a *pull-down menu*. The options in this feature appear as lists. Clicking the mouse on an option in a list changes the document. To return to the document, click the main menu item.

Figure 8-6 shows a pull-down menu for the FORMAT feature.

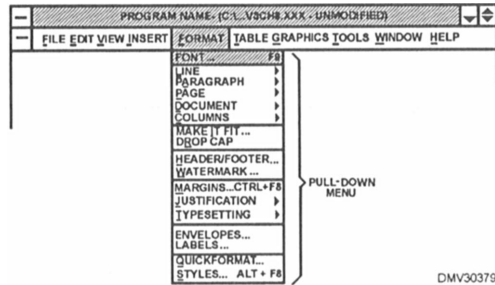

Figure 8-6.—Format feature pull-down menu.

There are additional pull-down menus to further define document parameters you want to change.

Figure 8-7 shows the menu feature FORMAT, the first pull-down menu, and the second pull-down menu.

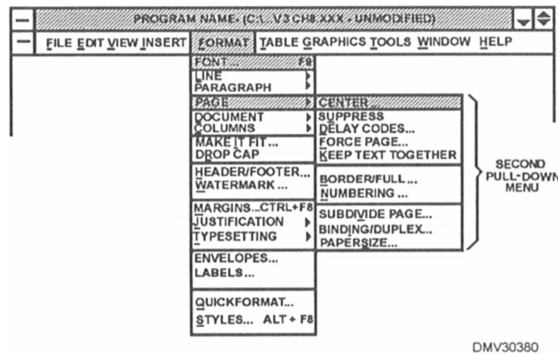

Figure 8-7.—A second pull-down menu.

Continued on next page

Common Software Features, Continued

Menus (Continued)

Further defining document changes leads you to a prompt that specifically addresses those changes you want to make. The window that prompts you to enter changes is called a *dialogue box*. Some dialogue boxes offer an options list that appears similar to pull-down menus. This options list inside the dialogue box is called a *drop-down list*. The dialogue box accepts the changes you select after clicking OK. If you accept the changes, the document immediately reformats reflecting the changes.

Figure 8-8 shows the dialogue box to change page numbers both in number ‘structure and page position.

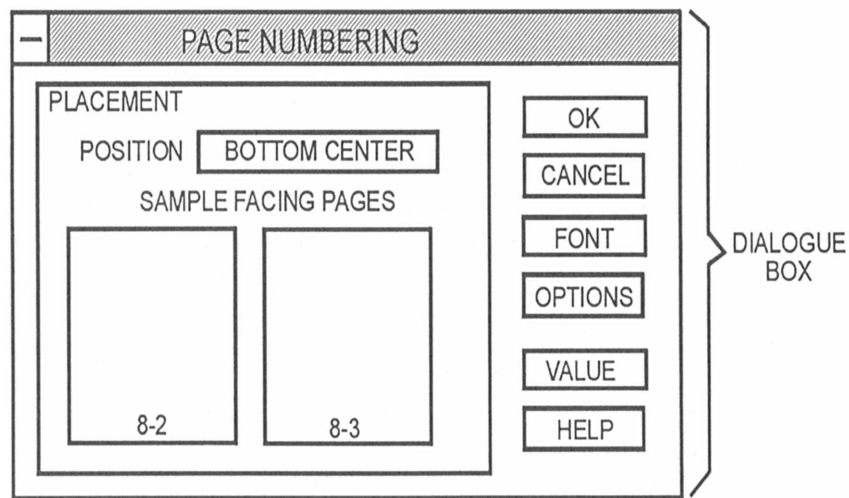

Figure 8-8.—A dialogue box for page numbering.

Continued on next page

Common Software Features, Continued

Menus (Continued)

You may click into menu features and find that some options on the list in the pull-down menu are dark and some are greyed out. Those features that appear 'dark' are currently available to you for use. Greyed out features are not available or are inactive options you cannot access.

Figure 8-9 shows the EDIT feature with greyed out and dark options.

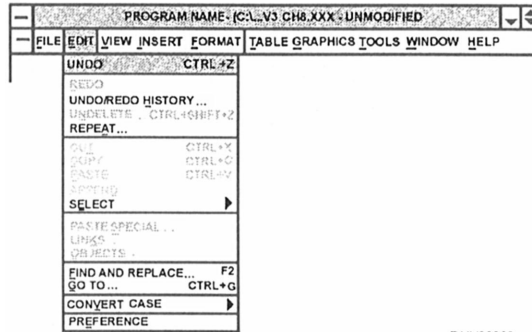

DMV30382

Figure 8-9.—Greyed out and dark options of the EDIT option.

Menu feature options terminating in three dots (. . .) require additional information from you before activating. For example, one option in FILE is SAVE. Clicking the SAVE (notice the absence of dots) option saves data in the hard drive, but clicking SAVE AS . . . requires you to indicate where you want the data to store or to indicate a different file name. If you did not name a document before clicking SAVE, the screen prompt automatically appears as SAVE AS . . . awaiting your input for the file name.

Figure 8-10 illustrates the difference in SAVE and SAVE AS . . . options in the FILE feature.

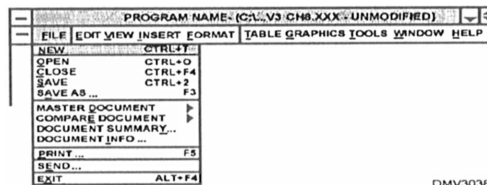

DMV30383

Figure 8-10.—The difference between the SAVE and SAVE AS... options.

Continued on next page

Common Software Features, Continued

Menus (Continued)

Some pull-down menus also have indicated keystroke sequences on the right side. These are the keystrokes and sequence code to access the function if you use a keyboard instead of a mouse.

Figure 8-11 shows the function codes in the FILE menu to access the function by keystroke.

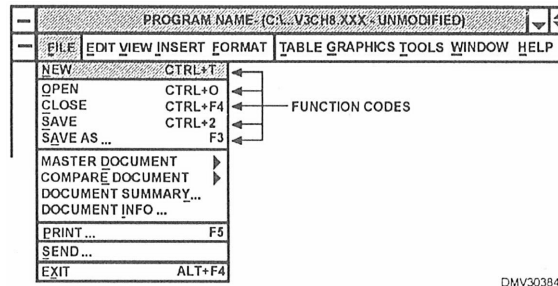

DMV30384

Figure 8-11.—Listed keystrokes as an option to access function codes.

Other symbols used in feature lists are check marks or bullets. Check marks show which option is selected. For example, look at the VIEW feature. A check mark next to TOOLBAR displays the toolbar on the top or side of the screen image. Clicking again on VIEW activates the option.

Figure 8-12 shows VIEW with the TOOLBAR option selected.

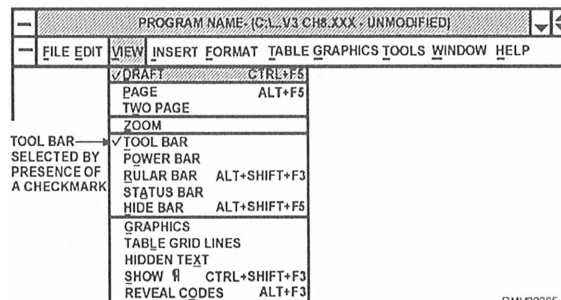

DMV30385

Figure 8-12.—The toolbar selected with the presence of a checkmark.

Continued on next page

Common Software Features, Continued

HELP

HELP is a feature that provides step-by-step instructions in some aspects of the software program installed on the computer. HELP displays appear on the screen and prompt you through selected functions. You may also print the HELP instructions to hard copy printouts. To make HELP displays disappear from the screen, click the CLOSE box. Most software programs have HELP features.

Figure 8-13 illustrates how HELP features lead SYSOPs through unfamiliar procedures.



DMV30386

Figure 8-13.—HELP features.

Continued on next page

Common Software Features, Continued

Scroll bars

Scroll bars are areas on the side and bottom of a monitor screen display that allow you to rapidly scroll or run through documents or software options by clicking and holding the mouse on the arrow pointing in the direction you want to travel. Scroll bars appear when there is more information or options than can be visibly displayed on the monitor. Inside the scroll bar is a square or box that indicates approximately where you are in the document.

Figure 8-14 shows a monitor screen with scroll bars at the side and bottom of the display.

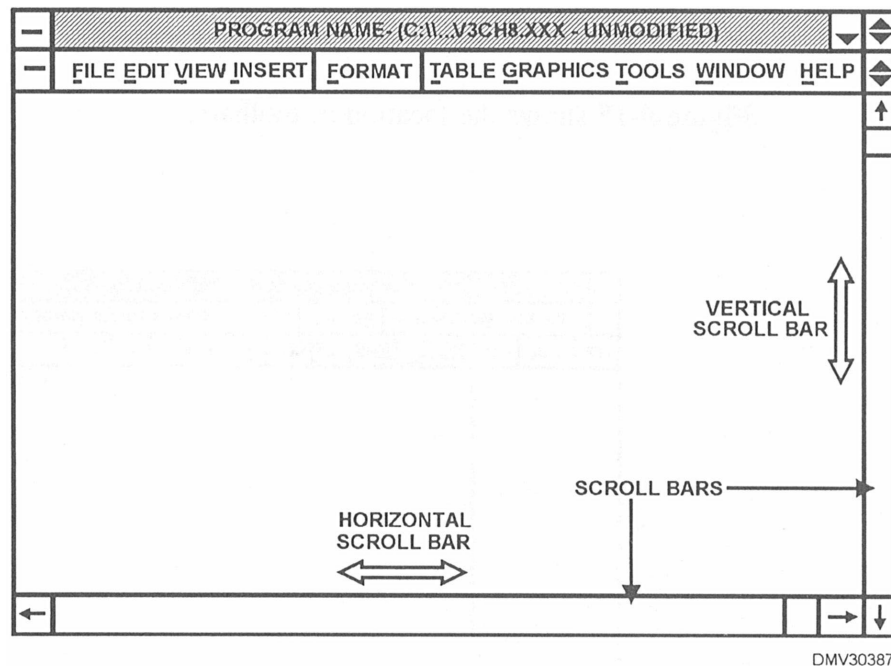

Figure 8-14.—Scroll bars.

Common Software Options

Introduction

Just as software programs standardize popular features, so, too, are options becoming standard. Popular options reoccur in many software programs. This segment discusses common software options without reference to individual programs. However, we do refer to some word processing software options in these discussions.

Toolbars

Toolbars are a collection of options displayed on the top or sides of monitor screens. The SYSOP may elect to display or not to display toolbars by clicking the pull-down menu under VIEW and placing or removing a check mark to the left of Toolbar. Toolbars consist of common options such as Font Face, Font Size, Justification, Line Spacing, Table Create, Column Define, Zoom, Font Attributes, Bold, Italicize, Underline, and Symbology. Software may also have program specific options on a separate toolbar that enable the SYSOP to maximize using the software.

Figure 8-15 shows the location of toolbars.

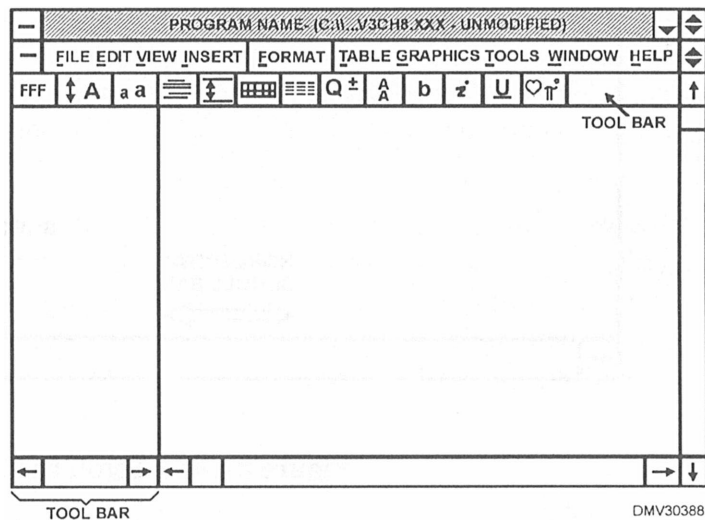

Figure 8-15.—Typical onscreen locations for toolbars.

Continued on next page

Common Software Options, Continued

Font-related options

Font-related options allow SYSOPs to change attributes in any font the software offers. Font attributes include letter style and size. Font Face refers to letter style and Font Size refers to letter size. Select Style accesses preset characteristics that define where the text appears on the page. For instance, using Chapter Heading under the Select Style option produces large, bold text typical of chapter titles.

Justification

Clicking on the button for Justification displays a small pull-down menu offering flush left or right, centered, or full justification. Selecting flush left or right aligns text on the left or right side margin. Centering text centers the line of text between the margins.

Line Spacing

Line spacing controls the amount of space between lines. Similar to typewriters, options include single spacing, 1 ½ spacing, and double spacing.

Tables and columns

Since tables and columns are often embedded in text, toolbar buttons offer the SYSOP a quick and easy method for creating tables and columns.

Zoom

The Zoom option allows you to look at document pages at different percentages of magnification or as a full page. This is helpful when page aesthetics are critical as in Welcome Aboard brochures and Change Of Command booklets or when you must fit a lot of information into a set space.

Bold, italics, and underline

Toolbar buttons marked “B,” “I,” and “U” offer the options of bolding, italicizing, and underlining text. To access these attributes, select the text, move the mouse to the appropriate toolbar button, and click. Deselect text before continuing in the document. If you fail to deselect, the text continues to bold, italicize, or underline.

Symbology

Scientific, mathematic, linguistic, and graphic symbols are available by using the Symbology toolbar button. The Symbol toolbar button prompts you through the sequence of selecting and inserting symbols.

Common Software Commands

Introduction

Software is developing a common language in the form of commands.

Commands

Commands are words recognized by the computer to access functions. Certain common commands appear in most software packages. You may access commands by pulling down the menus of the software features.

FILE feature

The FILE feature offers the commands of NEW, OPEN, CLOSE, SAVE, and PRINT. Clicking on a command either executes the command or offers a dialogue box.

NEW: Enter the NEW command when you start a new file. A dialogue box may appear to ask you to select a format for the new document.

OPEN: Access an existing document by clicking the command OPEN. A dialogue box appears prompting you to select from a file of existing documents. Once you select the document you want to open, click on the file name, and OK or double click the file name to open the file.

CLOSE: To close or exit a file, click CLOSE. A prompt appears that should ask if you want to save the document. Selecting the desired option automatically executes the function and closes the file.

SAVE: To save a file, click SAVE. The computer automatically saves the data to whatever drive you specify, hard drive or floppy disk and prompts you to name the file before saving it. To save data to disks or alternate hard drives in another format or to rename a file, click SAVE AS. . . and enter the letter designator of the disk or alternate drive.

PRINT: To print hard copies of an open document, click PRINT. A dialogue box appears asking if you want the entire document or a portion of the document, and how many copies you require.

Common commands are not the only commands you will see offered the FILE pull-down menu but, other commands may be program specific. Familiarize yourself with the software in your computer.

Continued on next page

Common Software Commands, Continued

EDIT feature The EDIT features offers commands like UNDO, CUT, COPY, and PASTE.

UNDO: The UNDO command deletes the last command given returning the document to its previous configuration.

REDO: REDO replaces data deleted by the UNDO feature or delete command.

CUT: CUT commands isolate a portion in the document and removes it. In effect, it cuts the portion from the text and moves it into the electronic clip board or scrapbook until you recall it later in the document or in another document. You may also delete the information entirely. The clip board empties when you exit the program or cut or copy new text.

COPY: The command COPY copies selected data. The information remains in the original document with a copy of the data placed in the clip board or scrapbook until the SYSOP requires it. Copied data may be repeated later in the same document or moved to another document. Again the clip board empties when you exit the program or cut or copy new text.

PASTE: PASTE is the command given when the SYSOP wants to recall data that has been cut or copied to the clip board in the document or into another document altogether.

Again, these commands are common to a majority of software programs. Your software program will have many other commands available.

Figure 8-16 shows the EDIT feature pull-down menu.

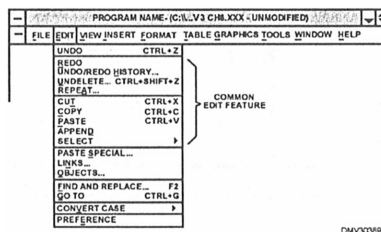

Figure 8-16.—Common EDIT features.

Continued on next page

Common Software Commands, Continued

VIEW feature Two of the most common commands in the VIEW feature are ZOOM and TWO PAGE.

ZOOM: ZOOM is a command that tells the computer to show more or less of the document page. ZOOM commands have preset percentages of magnification ranging from 25% to 200%. Some ZOOM commands allow the SYSOP to select the percentage of document to display. The ability to zoom into or out of a document is helpful when inserting graphics or copyfitting text.

TWO PAGE: In most instances, you will be working on documents in the PAGE mode where only the current page is displayed. The TWO PAGE command reduces the document image allowing two facing pages to appear on the screen simultaneously. This is desirable when you have to create Welcome Aboard or Change of Command brochures and need to view the pages side-by-side. Clicking on PAGE or TWO PAGE immediately executes the command without further prompting.

Figure 8-17 shows the TWO PAGE command for a multiple page document.

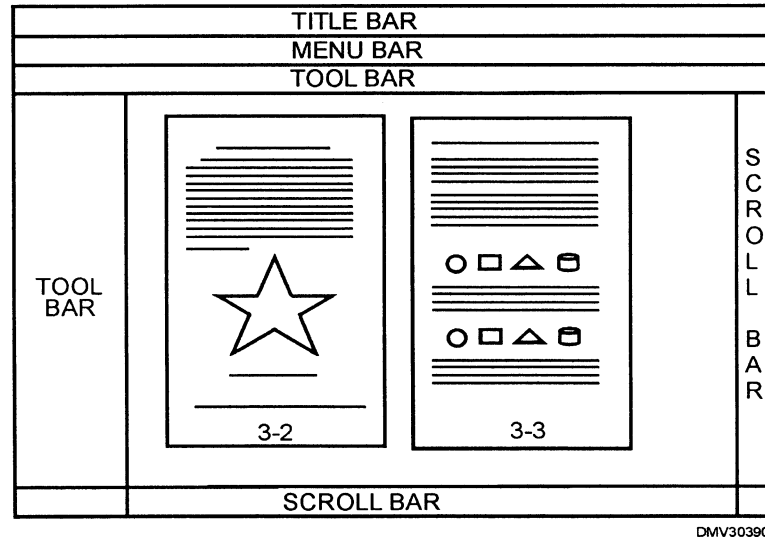

Figure 8-17.—Two pages displayed on screen simultaneously.

Continued on next page

Common Software Commands, Continued

TOOLS feature In the TOOLS feature are vital commands such as SPELL CHECK and THESAURUS.

SPELL CHECK: Clicking the SPELL CHECK command produces a dialogue box asking if the entire document or a portion thereof should run through SPELL CHECK. SPELL CHECK verifies the spelling of each word in the document. If it detects an error, SPELL CHECK offers alternate spellings or words for you to preview. Once you determine the correction, click to replace that word in the text. Run every document through the SPELL CHECK command. SPELL CHECK, however, cannot tell if a word is incorrectly or correctly used. Continue to manually proofread text before declaring a job finished.

Figure 8-18 shows a typical SPELL CHECK dialogue box.

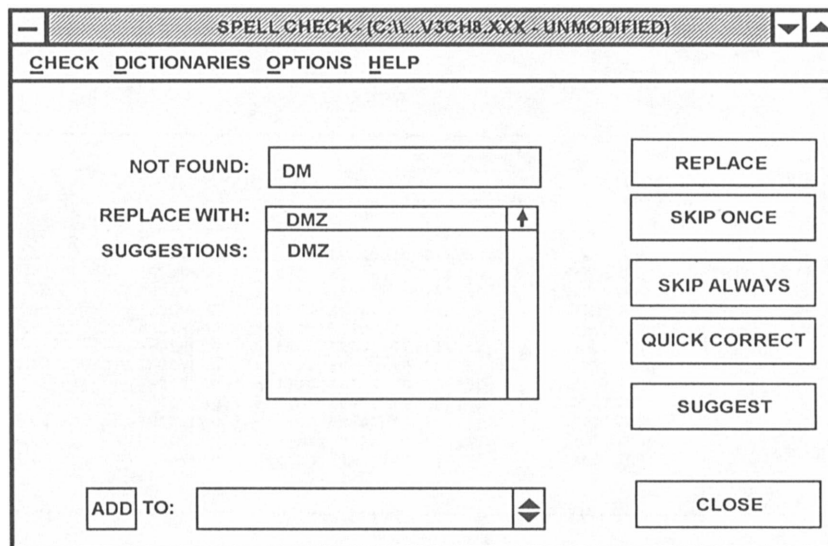

Figure 8-18.—A typical spell check dialogue box.

THESAURUS: The THESAURUS command offers synonyms to reduce repeating the same word or words. For individuals with limited vocabularies that often write text, a thesaurus is invaluable.

Directories and Subdirectories

Introduction

Data stored on disks requires a system of retrieval. Computers use hierarchal systems that go from general information in directories to specific information in subdirectories. Carefully plan the organization of information on disks and hard drives.

Directories or files

Directory files are groups of files that are extensions of the list file. The main file or directory, called the *root directory or parent directory*, is distinguished by a backslash (\). Other directories have file names followed by the abbreviation “dir” and are sometimes called *child directories*. Directories are limited in the number of files they can hold, which necessitates creating subdirectories.

Figure 8-19 shows directories or files of general data.

```
09-30-97 03:18p          Directory C:\WP51\DOC\*. *
Free: 74,334,208

Current  <Dir>                ..  Parent  <Dir>
MC      .                  ODHV1CH1.  76,366 07-20-95 03:35p
ODHV1CH2.  99,135 07-20-95 03:33p  ODHV1CH3.  36,941 07-20-95 03:36p
ODHV1CH4.  75,066 07-20-95 03:37p  ODHV1CH5.  57,737 07-20-95 03:38p
ODHV2CH1.  15,955 07-20-95 03:39p  ODHV2CH2.  16,305 07-20-95 03:41p
ODHV2CH3.  16,451 07-20-95 03:42p  ODHV2CH4.  16,962 07-20-95 03:43p
ODHV2CH5.  15,814 07-20-95 03:44p  ODHV2CH6.  24,411 07-20-95 03:45p
ODHV3CH1.  21,782 07-21-95 11:09a  ODHV3CH2.  17,503 07-21-95 11:32a
ODHV3CH3.  20,881 07-21-95 01:13p  ODHV3CH4.  17,241 05-06-97 09:27a
ODHV3CH5.  20,097 07-24-95 08:59a  ODHV3CH6.  22,245 07-24-95 09:21a
ODHV3CH7.  24,199 07-24-95 09:55a  ODHV3CH8.  20,558 07-24-95 10:06a
ODHV4CH1.  28,444 07-24-95 11:05a  ODHV4CH2.  20,902 07-24-95 11:22a
ODHV4CH3.  17,717 07-24-95 01:22p  ODHV4CH4.  14,510 07-24-95 01:28p
```

DMV30392

Figure 8-19.—A subdirectory from C:Drive.

Continued on next page

Directories and Subdirectories, Continued

Subdirectories or folders

Subdirectories or folders are files that have specific purposes or relationships. Subdirectories can contain anything and may become very large. Use subdirectories when several people use one computer and need to keep separate data files. Subdirectories are also used to keep different types of documents together or to separate files by commands.

Figure 8-20 shows how subdirectories or folders of specific data form a hierarchal system called a *directory tree*.

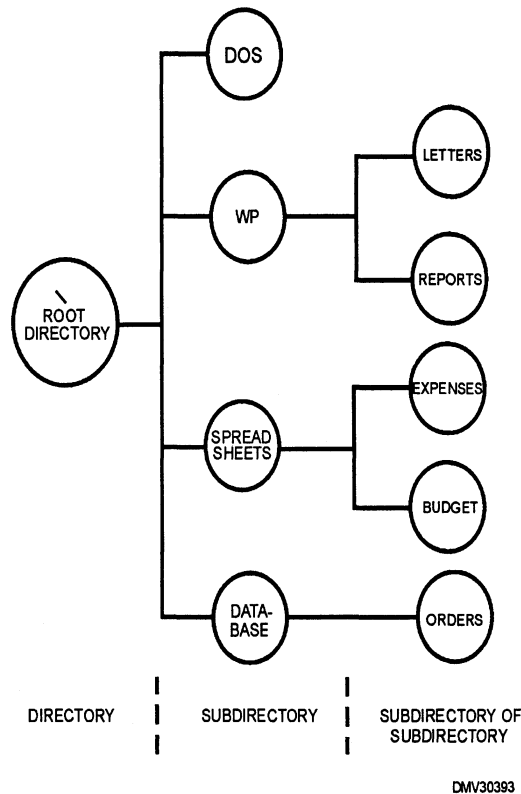

Figure 8-20.—Directory trees.

Continued on next page

Directories and Subdirectories, Continued

Naming a file or folder

The name of directories or files and subdirectories or folders should reflect information that identifies the contents of the document. A file name consists of eight characters and may have a suffix or three-character extension after a period. The three-character extension may indicate the type of document in the file. For example, ART indicates that the file contains artwork rather than text (TXT). The three-character extension may also indicate the format of the document. Do not use punctuation in file names. Use the *Department of the Navy, Standard Subject Identification Codes (SSIC), SECNAVINST 5210.11*, to assign file names with some uniformity.

File listings

You can access files in directories or subdirectories by displaying the list of files on the monitor screen or by printing hard copies. Store hard copy lists of the directory with the disk. File lists show the name of the file, how many bytes in the file, and the date of creation or modification. When the list of files are on-screen, options appear that allow you to OPEN, RETRIEVE, DELETE, MOVE/RENAME, PRINT, LOOK, OTHER DIRECTORY, COPY, FIND, or NAME SEARCH files.

OPEN: Opening files displays the document onscreen and allows you full editing capabilities in the file. When editing is complete, save the file before closing it or the changes may not be saved. A prompt to save before closing a file normally appears on screen.

RETRIEVE: Retrieving a document displays the information on the screen and allows you to modify data. Save all modifications before closing the file or the document may not save the changes.

DELETE: Selecting DELETE will remove the file from the root directory. If files contain subdirectories, a prompt informs you that the file cannot be deleted without deleting the subdirectories first. Many programs will ask you to confirm your request to delete a file.

MOVE/RENAME: Use the MOVE/RENAME option to move a file to another disk or drive or to rename a file.

PRINT: Selecting PRINT from the LIST FILE without selecting a particular file prints the file list itself. To print directories from the root directory, you must select them.

Continued on next page

Directories and Subdirectories, Continued

File listings (Continued)

LOOK: LOOK allows the system operator to view the selected document on the screen. You cannot make changes or modifications in this mode.

OTHER DIRECTORY: Using the option OTHER DIRECTORY elicits a prompt to indicate the desired directory. Once the computer knows which directory you desire, the file list for that directory appears on the screen.

COPY: To copy a file to another disk, select the file with the cursor and click on the COPY option. A prompt asks to what disk or drive to copy the information.

FIND: FIND and NAME SEARCH are very similar. If you know the document name or several key words or phrases, the software can search files until it finds a match.

NAME SEARCH: To find a particular file, some programs are capable of searching for files in several ways. Entering a few letters from the file name causes the program to look for any file name with those few letters. You can search by date or file/folder if you can remember the date you originally created the document or to which file or folder you saved the document. Some software programs are capable of searching for phrases within the text of documents.

Purging files

Purge old files from your working copy disks and hard drives weekly. Dispose of obsolete files by deleting them. Move infrequently required documents to finished media disks or disks set aside for archival purposes. Removing obsolete or excess files from working copy disks and hard drives reduces the time it takes the computer to scan and retrieve files speeding processing time.

Archiving

Archiving is saving infrequently used data on finished media disks or disks reserved for information only occasional required. For example, the ships Watch, Quarters, and Station Bill that is periodically updated and circulated would be better stored on finished media disks than on hard drives.

File Formats

Introduction

No one software program offers every option and you may want to move graphic files from one program to another to use other options. Proper file format is important if you plan to merge graphics into other software programs. Review software owner/operator manuals to identify formats the software supports for importation and exportation. Your graphics will not display or print if you save files in incompatible file formats.

File formats

File formats are machine languages that save each binary digit or bit in a file according to special codes that tell the program how to arrange and present the information. Special codes for one program are not necessarily the same special codes for other software. Two common ways files are saved to disks are by vector and raster bit maps.

VECTOR-BASED: Vector-based drawings or object-oriented graphics are plotted by a series of points that define paths for lines to follow. The points are the result of mathematical formulation and most vector-based software automatically recalculates subsequent changes. For this reason, vector-based drawings are simpler to edit than raster-based images. Vector images are defined by lines, shapes, color or fill pattern, and objects. Vector-based graphics printed or viewed on low resolution printers and screens, curves and circles appear mechanically awkward or jagged. The term for jagged edged lines is *pixilated*.

RASTER-BASED: Raster-based images are images created pixel by pixel within a matrix. Raster-based software automatically determines when and to what number to reduce pixels in a matrix. Vector-based bit maps can be “rasterized” or converted by a raster image processor (RIP) to raster bit maps. The purpose of conversion is to ensure reliable transport into the publishing software by dramatically increasing the dots per inch (dpi) resulting in very high resolution. Rasterizing images removes the jagged edges often associated with vector graphics reproduced at low resolution (lower dpi). Subsequent editing in raster-based software is often difficult and may require re-converting to vector-based software.

Continued on next page

File Formats, Continued

Saving file formats

The format graphics are saved in affects the resolution quality of the final product. Files saved in low-resolution do not produce professional quality graphics. Files saved in high-resolution file formats require software program compatibility to maintain high resolution or increase to very high resolution. Common file formats are the American Standard Code for Information Interchange (ASCII), the encapsulated postscript file format (EPS or EPSF), the tag image file format (TIFF), the raster image file format (RIFF), and the graphic images format (GIF). There are some file formats that are platform specific such as Amiga ILF/ILBN and Macpaint.

American Standard Code for Information Interchange (ASCII)

The American Standard Code for Information Interchange (ASCII) is a generic text-only format without special coding for attributes such as bolding, underline, and italicizing. You can open files saved in ASCII in any other program so long as you specify the format when opening the file or issue a special import command. ASCII does not handle graphics files.

Encapsulated postscript file formats (EPS or EPSF)

Encapsulated postscript file formats (EPS or EPSF) save graphics as high resolution images in color or black and white. EPS files consume more disk space than other file formats because they contain information required for color separation. Images saved as EPS files are particularly suited to high quality reproduction or commercial printing. EPS or EPSF is a vector-based format.

Tag Image File Format (TIF or TIFF)

Tag image file formats or TIFF is a common format for saving bit-mapped graphics. You can save any scanned line art or grey-scale halftone image in TIFF and import/export into desktop publishing programs or other graphics software for further manipulation. The TIFF file format is a vector-based format. TIFF is less capable as a format for color images than EPS.

Raster image file format (RIF or RIFF)

Raster image file formats (RIFF) is a PC image-editing program similar to TIFF in very high resolution. Vector-based formats may be converted to RIFF by a RIP.

Continued on next page

File Formats, Continued

Graphics images file format (GIF or GIFF)

GIF or graphic images file formats are display bit maps without the high resolution required for editing. GIF is used for display and exchange among users in subscription networks connecting vast networks of computers such as the Internet and the world wide web.

Joint photographic experts group (JPEG or JPG)

JPEG or JPG is a standardized image compression mechanism written by the Joint Photographic Experts Group for maximizing file compression of files intended for use as a Usenet or world wide web photo format. JPEG works best with full-color or grey-scale images such as photographs and continuous-tone art. JPEG has difficulty reproducing sharp lines and extreme contrasts. JPEG files also display a loss in image quality with subsequent conversions.

File format suffixes

Common three-letter file format extensions attached to file names include the suffixes in the following chart:

| Format | Suffixes |
|--|----------|
| American Standard Code for Information Interchange (ASCII) | .txt |
| Encapsulated Postscript File Formats (EPSF or EPSF) | .eps |
| Graphics Image File Format (GIF or GIFF) | .gif |
| Joint Photographic Experts Group (JPEG or JPG) | .jpg |
| Raster Image File Format (RIF or RIFF) | .rif |
| Tagged Image File Format (TIF or TIFF) | .tif |

File compression

When documents or images require more storage space than the disk has, compress the file to fit. Compressing files is a way to store back-up material, free hard drive space, and save time transferring files. Many programs are able to compress files and there are specific file compression software programs available. Compressed files must be expanded before use. Compressing and expanding files does not affect resolution. File compression is sometimes referred to as stuffing and unstuffing.

Word Processing Software

Introduction

Many computers in the Navy have some sort of word processing software installed. For DMs, word processing software composes flawless text for subsequent reproduction. Because there is a variety of text-handling programs in several different versions in the fleet, no attempt to address specific programs is made in this training manual. You must become familiar with your work center computer and the word processing software installed on it.

Word processing programs

Word processing programs create flawless documents by using extensive and sophisticated editing features that typewriters cannot offer. Editing features distinguish one word processing program from another. No one program contains all features. As word processing programs evolve, however, certain features become common.

Word processing software manuals

The most valuable source of reference for your computer and software package is the owner/operator manual. These manuals are meant to be used for reference daily. Keep the manuals handy. It takes a lot of experience before you can disregard the manual without losing computer capability.

Word processing software features

Word processing software features are standardizing as the medium evolves, but, part of evolution is the creation of and streamlined access to new features. Features that once took several keystrokes to access now have their own icon on toolbars and require only that you point and click the mouse.

Document formatting features

Before entering text into documents, set document parameters regarding margins, justification, text centering, setting text flush, setting headers, footers, endnotes, and page numbers. Define a document before you begin. Failure to define document parameters creates major control problems during corrections or revisions. Modifying documents with undefined parameters results in text splattered across the page and irregular margins. This is frustrating and confusing when you are trying to make corrections.

Graphics Software

Introduction Software programs that are highly regarded for text-handling abilities may not be appropriate software for handling artwork or images. To achieve the flexibility and resolution required to create good graphics, you need graphics software programs. Since so many graphics software programs are used in the Navy; this section addresses them only in general terms.

Graphics software programs Graphics software programs are intended primarily for the creation and modification of graphics images. The three types of graphics software programs are image-creation (drawing, animation, drafting, and painting), image-editing (photographic), and image-presentation (briefing or training) programs.

Graphics software program manuals Graphics software programs have so many features and options that an owner/operator manual is invaluable. Study software manuals and complete any exercises and recommended applications. Keep software manuals near computer work stations for easy reference.

Graphic software programs memory Memory requirements for graphic software programs exceed those for text-handling programs. Memory chips on CPUs store bytes of information in kilobyte (KB), megabyte (MB); or gigabyte (GB) increments. Random Access Memory (RAM) memory chips determine what programs your computer is capable of running and how much information you are able to store. Graphics software requires more RAM than text programs. When purchasing software to increase graphics capabilities, compare the memory capacity in the CPU to the memory requirements of the intended purchase. Add more memory chips to the CPU if required to handle the new software.

Image-creation programs Image-creation programs are programs that allow the SYSOP to create and manipulate images. Image-creation software programs include draw, paint, animation, and drafting software programs. The images may be initially scanned into memory or created solely by using options available in the software program. Drawing and painting software is generally raster-based and animation and drafting programs are vector-based programs.

Continued on next page

Graphics Software, Continued

Image-editing programs

Image-editing programs are used primarily with preexisting images such as pictures and photographs, scanned into memory for manipulation. Image-editing software shares many of the features and options available in image-creation programs with higher resolution and greater pixel manipulation. Image-editing programs often have greater selections of blending tools and stylizing filters than image-creation programs.

Image-presentation programs

Image-presentation programs offer cookbook solutions to the task of preparing information for presentation in briefs or in training environments. You select slide or viewgraph formats from menus in memory and plug information into it. You may import photographs and illustrations through scanners or select from stocks of copyright-free artwork held in memory as clipart. You program how the image appears and disappears from the screen and for how long the slide remains on the screen.

Common graphics software features

Features common to graphic software applications include the use of layering, movement tools, auto-trace tools, shape tools, rendering tools, blending tools, and stylizing filters. Each software program has its own set of tools. Your software program may have any or all of the following listed tools and features. You may have additional features that are program or platform specific but, whatever features and tools your software offers, get to know and understand how to use them.

Layering

Layering is creating art in stages or on electronic overlays. Every element of a design is placed on separate layers. Because the number of layers can become excessive, it is a good idea to combine or group layers that contain small design elements. Any layers so grouped may also be ungrouped. Most graphics programs create art in multiple layers with the exception of painting programs, which may use only one layer. Working in multiple layers gives you complete control of every drawing element and is convenient when preparing color separation work or isolating segments for changes. The disadvantage of multiple layers is that it complicates the creation process by making it difficult to select the appropriate layer to change and to assess how changes made affect previous and subsequent layers.

Continued on next page

Graphics Software, Continued

Movement or select tools

Movement or select tools extract and move image segments into the electronic clipboard or scrapboard for later recall and repositioning. Movement tool icons may resemble lassos (rope) or marquees (rectangle). Movement tools select pixilated images with some surrounding white space or white space enclosed within the pixilated image.

Isolating tools

GROUP, UNGROUP, and ISOLATE are forms of movement or select tools that allow you to separate design elements for detailed alterations.

GROUP: GROUP combines design elements from different layers onto one layer. Reducing the number of layers in illustrations simplifies image construction and occupies less memory space.

UNGROUP or ISOLATE: UNGROUP or ISOLATE isolates design elements for further manipulation. At times, you may have to ungroup elements, edit, then regroup them to successfully modify illustrations.

Auto-tracing tools

Auto-tracing tools are quick ways to repeat images without redrawing them. Auto-trace tools automatically plot vectors of traced images and convert them into drawn lines. You may have to refine and sharpen the traced lines before using them in your artwork.

Shape tools

Shape tools easily create shapes on screens by clicking a shape icon. You may then click and drag the shape on the screen until the shape reaches the desired size and form. Shape tools create circles, ovals or ellipses, squares or rectangles, or trapezoids and polygons. Shape tools draw precise lines, Bézier curves, and freehand lines. Shape tools that push shape limitations are SKEW, REFLECT, and SPIN or FREE ROTATION tools. SKEW shape tools angularly distort images much the way italicizing distorts text. REFLECT creates mirror images. SPIN or FREE ROTATION rotates design elements around a stationary point.

Continued on next page

Graphics Software, Continued

Rendering tools Rendering tools are electronic replicas of traditional drawing tools for drawing, tracing, and line work. To select rendering tools, click on the icon resembling the traditional drawing tool. . The input device (mouse, trackball, electronic tablet, or pen) used to draw imitates the effect of the traditional drawing tool. Some common rendering tools are the PENCIL, BRUSH, AIRBRUSH, ERASER, BUCKET, BLEND, EYEDROPPER, and TYPE.

PENCIL: With the PENCIL tool, you can draw lines resembling pencil strokes. You can change the width of the pencil stroke. Click the icon that resembles a pencil to access.

BRUSH: The effects of brush strokes are possible while working' with the tool BRUSH. The width of brush strokes is variable.

AIRBRUSH: The AIRBRUSH tool applies pigments in evenly sprayed patterns. The width of the airbrush stroke and the density of the pigment are adjustable.

Figure 8-21 illustrates the differences between rendering tools.

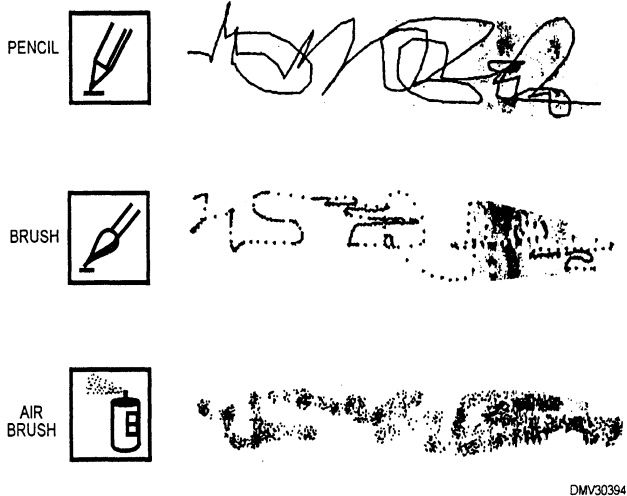

Figure 8-21.—The difference between the pencil, brush, and airbrush rendering tool.

Continued on next page

Graphics Software, Continued

Rendering tools (Continued)

ERASER: The ERASER tool removes strokes or pigmentation from areas much as pencil erasers remove graphite. By selecting ERASER, you erase everything you drag the eraser over.

BUCKET: The BUCKET icon appears as a bucket of pouring pigment and is used to completely fill enclosed spaces with pigment or patterns. If the object is not fully enclosed, the fill color or pattern spills into white spaces surrounding the object. Make sure the object you desire to pour pigmentation into is fully enclosed by pixels.

Figure 8-22 shows a fully enclosed object and a partially enclosed object filled with pattern by the BUCKET tool.

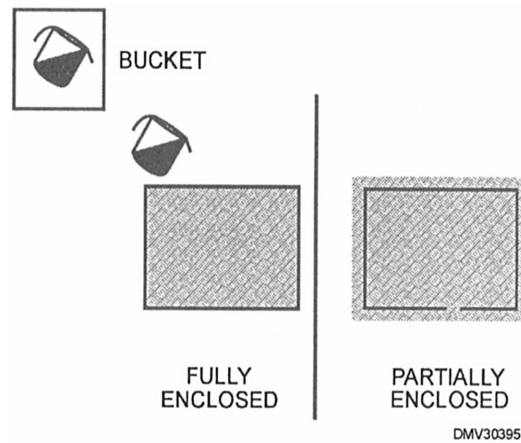

Figure 8-22.—The bucket tool fills objects with color or patterns.

BLEND: BLEND tools blur the distinction between one color or pattern and the next. Use a BLEND tool when you do not want distinct lines.

EYEDROPPER: Use the EYEDROPPER tool to mix and match any color on the illustration by extracting a sample of the original color with the eyedropper.

TYPE: Integrate text directly into graphic images without importing it from other software. Graphic programs offer a variety of fonts and sizes with the ability to outline, bold, shadow, and color letters.

Continued on next page

Graphics Software, Continued

Blending tools Blending tools blur the distinct lines between colors and patterns. They make sharp lines fuzzy and can zoom in and out of images. Some common blending tools are FEATHER, DEFRINGE, CLONE or RUBBERSTAMP, SMUDGE, CROPPER, GRABBER, ZOOM, PANNING, and SHARPEN.

FEATHER or DEFRINGE: Feathering or defringing creates a gradual transition between pixels on the edges of selected objects and backgrounds. This is useful when combining objects from different images to form one composition.

CLONE or RUBBERSTAMP: With CLONE or RUBBERSTAMP, you may copy objects, colors, or patterns and place them in other areas of the image. Retouching damaged areas on photographs or continuous-tone originals is easily done with this tool.

SMUDGE: The SMUDGE tools smears adjoining pixels with similar characteristics much like dragging fingers through wet paint smears color into the surrounding areas. This tool is excellent for softening unattractive features in portraiture used in Welcome Aboard biographies.

CROPPER: CROPPER tools crop selected portions of images and discard the rest.

GRABBER: To move objects larger than your open onscreen window, use the GRABBER tool and push or pull the image around on the screen.

ZOOM: Magnification of images or selected portions of images is possible with the ZOOM tool. This tool also pushes selected images into the background. Use this tool when determining the best composition.

PANNING: Moving from side-to-side across images like motion picture or video cameras is an effect accomplished by the PANNING tool.

SHARPEN: The SHARPEN tool increases or decreases image focus by altering the contrast in surrounding pixels.

Continued on next page

Graphics Software, Continued

Stylizing filters Stylizing filters are the whistles and bugles special effects of graphics software programs. Stylizing filters modify entire pixel maps. Some common stylizing filters include PIXELATION, WRAPPING or ENCRUSTING, STENCIL, DRAPING, TILING, POSTERIZE, THRESHOLDING, FACETING, CRYSTALLIZING, MOSAIC, NOISE, DIFFUSE, EMBOSS, FIND EDGES/TRACE CONTOUR, FRAGMENT, POINTILLIST or IMPRESSIONIST, SOLARIZE, SHARPEN, BLUR, and DISTORTION.

PIXELATION: PIXELATION is the selection of big or small pixels. Large pixels create jagged edges and amplify the computer-generated appearance of drawn objects.

Figure 8-23 shows pixelation on a circular form.

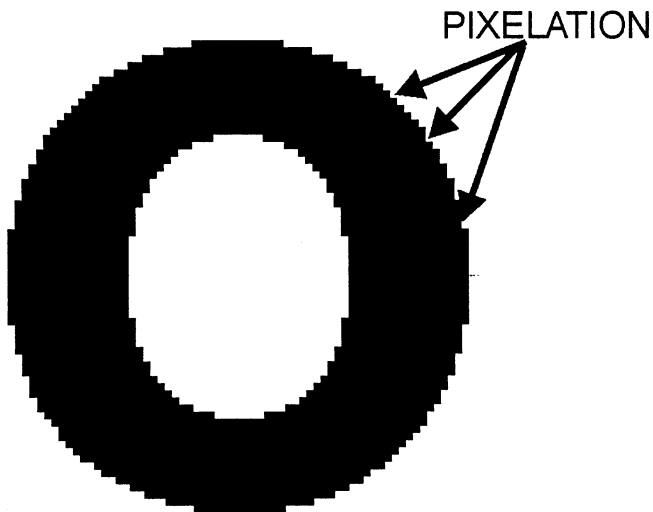

DMV30396

Figure 8-23.—Pixelation on the circular form of the letter “O”.

Continued on next page

Graphics Software, Continued

Stylizing filters (Continued) WRAPPING or ENCRUSTING: WRAPPING or ENCRUSTING contours colors and patterns around shapes.

Figure 8-24 shows the effects of wrapping pattern around a sphere.



Figure 8-24.—A pattern wrapped around a sphere.

STENCIL: To lock all areas of your image together, use the STENCIL feature. STENCIL makes all areas of the image dependant on each other. This feature is sometimes referred to as color masking.

DRAPING: Adding a pattern to objects to resemble the drapes and folds in cloth is called DRAPING.

Figure 8-25 shows an example of draping pattern over a sphere.

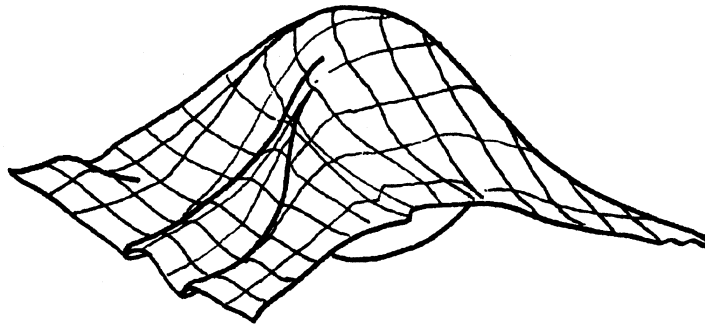

Figure 8-25.—Draping.

DMV30398

Continued on next page

Graphics software, Continued

Stylizing filters (Continued)

TILING: TILING creates patterns and saves them to tiles. Repeating pattern tile creates texture that you can add to any object.

POSTERIZE or SOLARIZE: Posterizing alters contrast levels in images into which you may add colors or patterns. SOLARIZE is similar to POSTERIZE except that the alteration approaches contrast extremes and the image remains monochromatic. These filters are useful for separating art for color reproduction or silk screenings.

THRESHOLDING: To reduce images to essential black-and-white areas, use the THRESHOLD command.

FACETING: Create blocks of like-colored pixels by using FACETING to group pixels together.

CRYSTALLIZING: CRYSTALLIZING arranges similarly colored pixels into polygonic or hexigonic shapes resembling cut stones.

MOSAIC: With MOSAIC, you can specify the size and position of blocks of pixels. This filter is useful and commonly used to obliterate identifiable features in photographs and television.

NOISE: The NOISE filter replicates television transmission noise by adding random patterns to illustrations.

Figure 8-26 shows NOISE.



DMV30399

Figure 8-26.—Noise

Continued on next page

Graphics Software, Continued

Stylizing filters (Continued)

DIFFUSE: DIFFUSE filters soften images to appear slightly out of focus.

EMBOSS: To impart three-dimensional effects to design elements, use EMBOSS. The affected elements appear lifted from the screen or paper surface.

FIND EDGES/TRACE CONTOUR: This filter reduces images to line drawings by tracing borders and outlines.

FRAGMENT: The FRAGMENT filter multiplies images and offsets them from each other.

POINTILLIST or IMPRESSIONIST: The POINTILLIST or IMPRESSIONIST filters convert illustrations and paintings into thousands of colored dots that imitate the paintings of the mid- to late-nineteenth century painting style of the same name.

SHARPEN: Use this command to slightly sharpen the outline of design elements or out-of-focus elements in photographs. SHARPEN filters may pixelate or degrade resolution when used excessively.

BLUR: The BLUR filter has multiple applications. Use BLUR to soften images or to softly haze backgrounds. Blur filters can be used to vignette images. BLUR can also create the appearance of sudden movement.

Figure 8-27 shows how BLUR filters can be used.

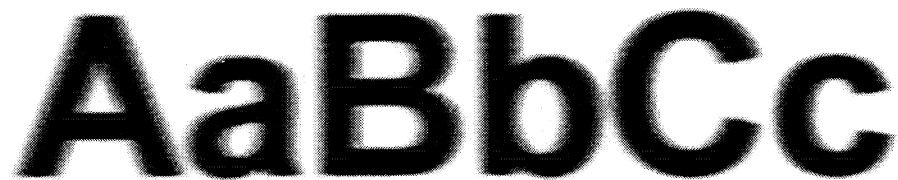

AaBbCc

DMV30400

Figure 8-27.—Using a blur filter.

Continued on next page

Graphics Software, Continued

Stylizing filters (Continued)

DISTORTION: DISTORTION filters distort or alter objects, patterns, and textures. They come in a variety of special effects including PINCH, RIPPLE, SPHERIC, TWIRL, and WAVE. You can expect many more special effect filters to show up in more sophisticated software programs.

Figure 8-28 shows examples of some common distortion filters.

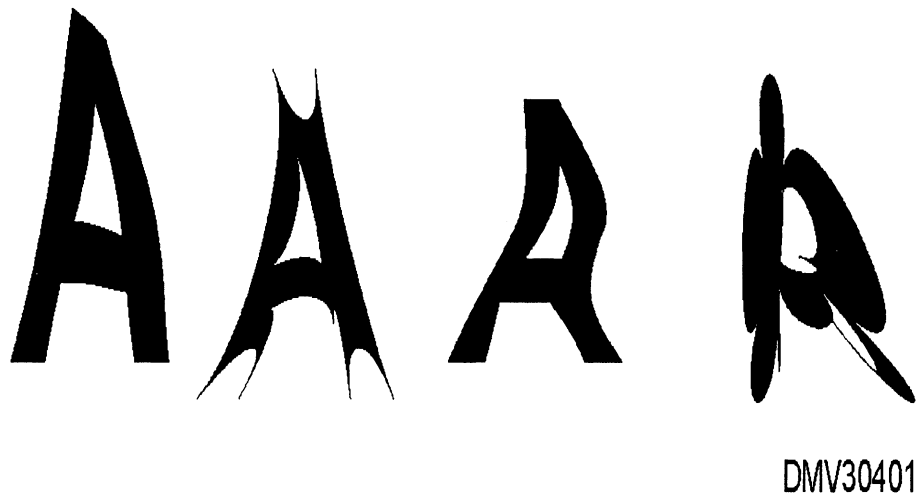

Figure 8-28.—Distortion filters.

Continued on next page

Graphics Software, Continued

Color capabilities

Using color graphics software programs requires more than 16 MB of RAM to run efficiently. Files saved in color are also memory hungry. The most basic color board is an 8-bit card supporting 256 colors onscreen simultaneously. Each bit receives eight bits of information to display a color. Colors boards containing 24-bits have the ability to produce 16.8 million onscreen colors. These 24-bit cards create continuous colors that blend smoothly. Increase shop versatility by installing a 2 MB 24-bit color card.

Color formats

Computer color can be created in RGB (Red, Green, and Blue), CYMK (Cyan, Yellow, Magenta, and Black), or Pantone color formats. RGB is the format normally used on cathode-ray tubes in computer monitors. Colors appear vivid and bright, but do not translate well into printed images. CYMK is the format used when preparing artwork for print. CYMK color appears less intense. Convert RGB color imagery to the CYMK format before printing or initially create imagery in the CYMK color format. Pantone color is used for spot color and should not be used in four-color process printing.

Color special effects

Illustrations resembling the high resolution of fine color photographs are attainable using programmable color palettes. Onscreen color special effects filters make it easier to mimic traditional art media and substrate surfaces.

CHARCOAL: To subtly add shade to color, use the CHARCOAL tool. This replicates pastels in texture.

WETPAINT: This special effects tool keeps onscreen images fluid. Painted areas in WETPAINT remain moveable and you are able to manipulate the painted mass until saved.

OVERPAINT or UNDERPAINT: Similar to overpainting and under-painting in the traditional media of watercolor, oil, and acrylic pigments, the OVERPAINT or UNDERPAINT tools allow the application of colors over and under already existing color.

WASH, SHADE, or STAIN: These effects simulate glazing in traditional art media. Color applied by WASH, SHADE, or STAIN options appear in thin, transparent shades.

Continued on next page

Graphics Software, Continued

Color special effects (Continued)

COLOR CYCLING: To simulate movement in images created onscreen, try the COLOR CYCLING effect. Perceived movement is achieved by displaying pixels in set palettes or selected palettes in a rainbow-like gradient.

SMEAR: The SMEAR tool allows you to push and move colors and patterns around onscreen as if they were wet paint. The smudges, smears, and softened edges resemble the effects of pastels or impasto.

BRUSHES: More sophisticated image-editing software programs not only have brush and brush size selections but also are capable of being pressure sensitive. Some software offers bristly or smooth brush hairs for dry brush and smooth applications of pigments.

EFFECTS: To create more painterly effects, graphics software programs have pigment application effects resembling oil paint, pastel, felt tip, and colored pencil textures.

SURFACES: Just as media textures vary so can substrate surfaces. The SURFACES special effects options visually emboss images with substrate surface texture resembling canvas, rough and smooth Bristol board, linens, and weaves.

Working in color

Overuse or improper use of color is offensive. Practice the principles in color theory.

To increase resolution in final printed products, create the art in DPI (dots per inch) at twice the intended printed lines per inch (LPI). The higher the resolution, the fewer problems you have with moire and tonal patterns.

Work with color by creating masters in monochrome first. Once you save the monochrome images, experiment with color variations on copies. This develops a sense of the most economical and effective use of color.

Periodically save line drawings at various stages of completeness as separate files. Should you make mistakes or change your mind about applying a particular color or pattern, return to the last line drawing saved.

Desktop Publishing Software

Introduction

DMs may need to become familiar with desktop publishing software, particularly in the absence of Lithographer's Mates. Desktop publishing is used for Welcome Aboard brochures, local instructions, newsletters, Personnel Qualification Standards (PQS), forms, and training manuals such as this one, which uses a user friendly desktop publishing program that provides easy graphics importation.

Desktop publishing software

Desktop publishing software is software programs that combine the textural manipulation of word processing software with graphics importation for subsequent reproduction. Common categories within desktop publishing programs include text composition, page layout, and graphics.

COMPOSITION: Composition defines the sizes and styles of type, the amount of space between horizontal letters and vertical lines, and the coding of the text copy to meet standards. You can edit text directly or input text from documents created in word processing programs imported into DTP software.

LAYOUT: Layout involves the arrangement of text and graphics on the page. Electronic pasting moves text from one position to another and incorporates graphics into text. Some features include multiple columns, column widths, and gutter space manipulation, printing vertically or horizontally on a page, automatic copyfitting, automatic page numbering, and adding headers and footers.

GRAPHICS: DTP features may scan or import illustrations and graphics either from hard copy or digital data. You can alter or edit images by shrinking or expanding them and create layered four-plate color separations for color reproduction.

Desktop publishing software programs sometimes use tags, frames, and style sheets to logically divide tasks involved in composing, layout, and graphics importation to create camera-ready copy.

Continued on next page

Desktop Publishing Software, Continued

Desktop publishing software manuals

Desktop publishing programs specifically code documents for print. Desktop publishing programs (DTP) tend to be more complicated and precise than word processing or graphics software programs. It is imperative to keep DTP manuals near the computer for continual reference. Incorrect document coding may cause printing errors in the finished product.

Tags

Tags are a group of selected stylistic and typographical attributes that define the appearance or style of paragraphs. The style and topographic attributes include letter style or font, alignment, spacing, breaks, tab sets, special effects, attribute overrides, and paragraph typography. You may also select ruling lines, boxing, or colors. All selected specifications are saved as tags and applied to text in a current document or imported into other documents. Practice good design principles and avoid mixing too many fonts or design elements. Tags must be named for identification and later recall. Name tags according to hierarchy, type, group, or alphabet with a 13-character name.

Frames

Frames are the basic element in the creation of desktop published documents. Frames are box outlines that hold text on pages by defining page size, orientation, margins, and columns. Do not use frames if tags will do the same job because frames require manual manipulation and tags do not. You can create, layer, or delete frames at will or use frames as place holders for inserting graphics. More than one frame may fit on a page simultaneously.

Style sheets

Style sheets are collections of tags, frames, and other information pertinent to the layout of a page. Style sheets determine the appearance of the printed page. When you create style sheets, name and identify them as style sheets with the suffix STY. You may use only one style sheet for each document, but you may switch style sheets in the middle of documents. Switching style sheets allows you to view documents in different presentations and select the best design.

Web Pages

Introduction

Designing web pages is currently one of the fastest growing functions of the Illustrator Draftsman. The Navy is beginning to see the web as an important part of its public image. In efforts to generate interest in the Navy, in individual commands, and in the mission of each command, every command is creating web pages for public view. Increasingly sophisticated web pages require thoughtful and thorough planning by the DM. To view the U. S. Navy web page, enter the Internet address of <http://www.navy.mil>. To review the latest advancement requirements in the Illustrator Draftsman rate, enter the Internet address of <http://www.cnet.navy.mil/netpdtc/>.

Web pages

A web page is a computer-generated public introduction to an organization,, command, or unit distributed worldwide via Internet. Web pages also advertise products and provide information. Worldwide Internet transmission is on a network termed the world wide web (WWW). Web pages may contain internal and external links offering additional information and options to viewers.

Web page design

Effective web design requires designers to consider fundamentals such as who the web page is trying to reach and what are they trying to communicate. How much or how little information is appropriate? How often will web pages require updating? Will web pages include schedules or phone directories? Individuals who visit or “hit” web sites want to access information quickly. Plan web sites to logically inform and present a positive image.

Web links

Web links are external and internal transfers to other web sites. External links lead web users away from the main web page. On a command web page, for example, external links may lead the viewer to web sites such as base housing, BEQs, and other Navy web pages. Internal links lead viewers further inside the command into such areas as departments, offices, and shops. Reserve most links for internal transfers to keep web users focused on the command web site. Do not place information on web pages that is subject to Privacy Act protection or in violation of security regulations.

Continued on next page

Web Pages, Continued

Frequently Asked Questions (FAQs)

Frequently Asked Questions (FAQs) are web pages that attempt to answer questions that might reasonably be asked by individuals seeking information on the main web page topic. Questions on command web FAQ pages may relate to command mission, organizational structure, projected deployment schedules, or ship construction statistics. Web users accessing command web pages may be potential shipmates evaluating the desirability of duty at the command. Append FAQs as an internal link to command web pages and update information regularly.

Web page parameters

There are some elements in designing web pages over which you have no control. These elements include the inability to alter page width, texture, and typography. You have no control over the publishing medium or analogous characteristics such as monitor contrast, brightness, resolution, and color settings. You also do not know the speed of the receiving station or the type of browser software (the program used to access a web site). All of these elements affect the way your web site is transmitted and received.

Designing web pages

The keys to designing effective web pages are simplicity and logic. Gather all information beforehand and script it into a logical presentation. Delete nonessential information. Use small, easily drawn icons and simple color palettes. Determine whether or not the commanding officer, executive officer, or command master chief want to address the web with an official Welcome Aboard or command introduction. Canvas the Ombudsman to see if he or she would like the opportunity to share information on an internal web page link. Plan web pages to allow web cruisers to revisit or jump from one link to another smoothly. A typical sequence for command web pages and internal links may be command, commanding officer (or executive officer) welcome, mission, statistics, deployment schedule, command master chief, FAQs, and Ombudsman information.

Web page language

All web pages are created in Hyper-Text Markup Language (HTML), the standard language format for creating documents, and transferred between web sites by hypertext transfer protocol (http). Some software program screen displays allow you to construct information in a more what you see is what you get (WYSIWYG) fashion.

Continued on next page

Web Pages, Continued

Web addresses A web address is an identification address assigned to a computer. Most web addresses begin with “http://” because that is how information moves on the web. The next part of the address usually contains “www” to identify the address as a World Wide Web address. The site specific (command) portion of the address follows “www” and may consist of the command acronym. The web address terminates in a period and suffix (abbreviation) that identifies the domain or type of computer using the address. Notice that web addresses are in lowercase letters. The following table lists common domains.

| Domain | Abbreviation |
|--------|----------------|
| .com | Commercial |
| .edu | Educational |
| .gov | Government |
| .mil | Military |
| .net | Freenet |
| .org | Organizational |

Figure 8-29 shows typical web addresses.

`http://www.whitehouse.gov`

`http://www.voyager.paramount.com`

`http://www.navy.mil`

DMV30402

Figure 8-29.—Typical web addresses.

Reviewing web Pages

Once you create a web page, view it using as many different browsers as you can. The web page content may disarrange when translated and viewed with other browsers. You can correct or adjust distortions by modifying the HTML code.

Summary

Review

This chapter is an overview of software programs, features, options, and commands common to Navy graphics shops in the fleet. There is no attempt to identify specific programs or to support one program over another. Software and disk security emphasizes the importance to national security of proper disk handling. The virus segment helps identify and avoid importing problems into the system. Familiarity with features, options, and commands common to many software programs should encourage exploration in program specific attributes. The segments on directories and subdirectories and file formats introduce common file construction. Discussions on word processing, graphics, and desktop publishing software are necessarily generic to avoid the pitfalls of locking onto one specific program. Web page construction represents your command to the world and deserves careful planning and execution.

Comments

Computers play an increasingly important part in your life as a DM with computer-generated imagery as one of the fastest growing commercial fields in the world today. Experiment with the software programs on your work center computer. Your attitude toward computers and your ability to work with them may determine your future success as a DM and the future of the rate in the Navy. Stay abreast of developments. To create successful computer-generated layouts and graphics still requires a traditional foundation in draftsmanship, composition, color harmony, value, texture, and light. Without the knowledge of graphic design principles, computer-generated art approaches technological sterility and discord. Cultivate applications for computer-generated imagery in your command. Aggressively seek and take responsibility for web page construction and other potential graphic applications in your command to keep the rate alive.

APPENDIX I

GLOSSARY

Glossary

Introduction One important key to success in any technical rate is mastery of the language associated with it. Learn the glossary as an integral part of your learning process. Use the terms other professionals are using in your field.

A **ACCENT LIGHT**—A light that highlights or emphasizes the subject in a scene.

ACETATE—Tough, transparent, or semitransparent sheets available in various thicknesses used as overlays in color separation, friskets in retouching, cels for animated drawings, and displays. Treated acetate readily accepts ink and paint.

ACHROMATIC—Black, white, and the grays in between.

ACRYLIC PAINTS—See **POLYMER**.

ACTINIC LIGHT—The short waves of the light spectrum (green, blue, and ultraviolet) that cause chemical changes in light-sensitive photographic emulsions.

ACTION LINES—Extra lines drawn around or following a cartoon figure or object to emphasize motion.

ACTIVATOR—The solution or chemical that starts the reaction of the developing agent in a photosensitized emulsion.

ADDITIVE PROCESS—A process that produces white light by starting with darkness and combining colored light.

ADHESIVE—(1) A gelatin or casein used as a binder in pigment; (2) A chemical compound used as a glue.

Continued on next page

Glossary, Continued

- A (Continued)** **ADVANCING COLORS**—Colors that appear to come forward, such as red, yellow, and orange.
- AESTHETIC**—Pertaining to the beautiful, particularly in art.
- AGATE**—Type size of 5 ½ points.
- AIRBRUSH**—An atomizer that applies a fine spray of paint under pressure from a tank of compressed air or carbonic gas.
- AIRBRUSHING**—Using an airbrush to create art or improve the appearance of art.
- ANALOGOUS COLORS**—Colors closely related to one another on a color wheel, such as blue, blue-green, and green.
- ANATOMY**—The bone and muscle structure of humans and animals as it affects the appearance of surface forms and contours.
- ANGLE**—A figure formed by two lines or planes extending from, or diverging at, the same point.
- ANHYDROUS AMMONIA SYSTEM**—A system that uses a mixture of water and ammonia in the developing section of some whiteprint machines.
- ANILINE COLORS**—Brilliant colors derived from coal tar that tend to fade in time.
- ANIMATED CARTOON**—A cartoon drawn in a series of progressive actions to give the effect of continuous movement.
- ANIMATION**—Sequentially drawn pictures displaying a range of motion which, when viewed in rapid succession, appear to be moving.
- ALIGNED SECTION**—A sectional view that revolves some internal features into or out of the plane of view.
-

Continued on next page

Glossary, Continued

- A (Continued)** **AMERICAN STANDARDS ASSOCIATION**—*Also called ASA. See ISO or EXPOSURE INDEX.*
- ANTIQUÉ STOCK**—A rough-surfaced paper, such as wove or laid.
- APERTURE**—An opening behind the lens that allows exposure to one frame of film.
- APPLICATION BLOCK**—The part of a drawing of a subassembly, showing the reference number for the drawing of the assembly or adjacent subassembly.
- ARC**—A portion of a curved line.
- ARC LAMP**—A light source resulting from the application of current to two carbon electrodes that form an electric ‘arc.
- ARCHITECT’S SCALE**—A scale used when dimensions or measurements represent feet and inches.
- AREA (PICTURE)**—The flat surface within the border of a picture.
- ARROWHEAD**—An indicator shaped like an elongated triangle used at the end of a lead line to direct attention to an object or a point of reference.
- ART**—Any copy other than text; any photograph, painting, or drawing in line, halftone, or continuous tone.
- ART BRUSHES**—*See BRUSHES.*
- ART GUM**—A soft, grit-free eraser used to clean drawings and remove unwanted pencil lines.
- ARTIST’S BOARD**—*See ILLUSTRATION BOARD.*
- ARTWORK**—Illustrations, drawings, photographs, renderings, paintings, sketches, and copy.
-

Continued on next page

Glossary, Continued

A (Continued)

ASCENDERS—The part of lowercase letters that project above the main body waistline, such as h, d, and f.

ASPECT RATIO—The proportion of the media format that governs the size of the original artwork.

ASSEMBLE EDITING—Putting scenes in chronological or progressive order.

ASYMMETRICAL—An informal balance of objects or sections of equal mass and weight on each side of a center line.

ATTITUDE—A position or action of the body or part of the body that approximates an emotion, character, or personality.

ATTRIBUTES OF MEDIA—Specific characteristics of a chosen medium.

AUDIO—Sound that is heard.

AUDIO-TUTORIAL—*Also called* AT. Instructions given to a student that uses primarily sound.

AUDITABLE PICTURE ADVANCE SIGNAL—An audible signal that indicates the moment to change the image to another.

AUTO-TRACE—A software option that allows the tracing of one image into another file option.

AUXILIARY VIEW—A drawing showing the true shape of objects that have features not parallel to the three principal planes of projection.

AXONOMETRIC PROJECTION—A drawing that shows the inclined position of an object in an isometric, dimetric, or trimetric format.

B

BACKGROUND ART—Design, texture, pattern, or other form of artwork used to create a background effect for type and illustration.

Continued on next page

Glossary, Continued

- B (Continued)** **BACKUP**—The registration of two sides of a printed sheet.
- BALANCE**—A harmonious arrangement of the various components in a picture plane in a symmetrical (formal) or asymmetrical (informal) format.
- BALL-AND-SOCKET JOINT**—A flexible joint that rotates in all directions.
- BALLOON**—(1) A space containing the words spoken by cartoon characters; (2) A distortable shape used as a base to draw a cartoon head.
- BALLOON LETTERING**—Informal, single-stroke lettering used in comic strip balloons.
- BAR CHART**—A graphic representation comparing numerical values by means of rectangles of equal width.
- BASE ART**—*Also called* BASIC ART and BLACK ART. *See* BLACK ART.
- BEADED SCREEN**—A screen comprised of glass or plastic beads that reflect light from a projected image.
- BEAM COMPASS**—A compass capable of drawing circles and arcs that exceed the limits of a standard compass.
- BEND ALLOWANCE**—An additional amount of metal used in a bend in metal fabrication.
- BENDAY**—Mechanical shading applied to artwork to give a variety of tones to line drawings. Benday is named for its inventor, Benjamin Day.
- BÉLZIER CURVES**—A computer tool that draws precise curves with great accuracy.
- BILL OF MATERIALS**—A list of standard parts or raw materials needed to fabricate items.
-

Continued on next page

Glossary, Continued

- B (Continued)** **BINDER**—An adhesive, coagulate, reducer, or extender added to pigments to maintain consistency, to promote adhesion, and to facilitate application.
- BISECT**—To divide into two equal parts.
- BIT**—The smallest unit of electronic information a computer can handle.
- BIT MAP**—*Also called* PIXEL MAP. A matrix of dots or pixels.
- BLACK ART**—*Also called* BASE ART. Art used in making process plates for illustrations of two or more colors.
- BLACK-AND-WHITE**—(1) Line art executed in a black-and-white medium only; (2) Continuous-tone art executed in black, white, and intermediate tones.
- BLACK PATCH**—A black masking patch pasted into the exact size and location on artwork where a photograph is to appear on the reproduction copy.
- BLEED**—The borders on the artwork and printing plate that extend beyond the final trimmed edge of the sheet.
- BLENDING**—Mixing or incorporating one color or tone with another.
- BLOCKING IN**—Indicating the broad outline of objects or shapes in a picture using preliminary lines.
- BLOCK OUT**—Eliminating an unwanted section of a picture.
- BLOWUP**—An enlargement.
- BLUEPRINT**—A direct, positive print made on chemically treated paper from a translucent or transparent drawing.
- BOARD**—Any heavy material used for mounting art or making displays.
-

Continued on next page

Glossary, Continued

- B (Continued)** **BOARD ART**—Any artwork mounted on heavy board stock.
- BODY TYPE**—Type used for the main body of text in printed matter.
- BOLDFACE**—Type emphasized by darkening or increasing letter weight.
- BOOKLET**—A pamphlet bound within paper covers.
- BOOT-UP**—Start-up of the computer.
- BONE**—An instrument with a plastic, agate, or metal tip used for burnishing shading sheets, pressure-sensitive letters, and paste-ups.
- BORDER AREA**—The areas around a graphic that represents a protective perimeter.
- BOUNCE LIGHT**—Lighting set up to reflect from nearby surfaces onto a subject.
- BOURGES PROCESS**—A method of color separation using prepared colored or toned papers or acetate sheets.
- BOW INSTRUMENTS**—Drafting tools that draw circles and arcs less than one inch in diameter.
- BOX**—To enclose with borders or rules.
- BREAK LINE**—Lines to reduce the graphic size of an object, generally to conserve paper space.
- BRIEFING CHART**—*Also called BRIEFING PAD.* A visual aid that presents information on large paper or board.
- BRIGHT**—A short haired, flat, chisel-shaped brush.
- BRISTLE.**—A hog hair brush used primarily in oil painting.
-

Continued on next page

Glossary, Continued

- B (Continued)** **BRISTOL BOARD**—A drawing surface made of fine, tough, flexible cardboard available in several thicknesses and in a variety of surfaces.
- BROADSIDE**—*Also called* BROADSHEET. A large, folded advertising piece.
- BROCHURE**—A bound pamphlet.
- BROKEN COLOR**—Two or more colors applied simultaneously to artwork without prior mixing or blending.
- BROKEN OUT SECTION**—An auxiliary view used when a partial view of an internal feature is insufficient.
- BROWNPRINT**—A photographic print or silverprint that produces a brown image.
- BRUSHES**—A collection of bristles or hairs used to apply pigment and glues.
- BULLET**—A symbol (●) used to preface listed items.
- BURNISH**—The application of pressure to secure paste-ups, shading sheets, and lettering to artwork.
- BURNISHER**—*Also called* BONE. An instrument made of plastic, wood, glass, metal, stone, or ivory used to flatten, smooth, or polish a surface with hand pressure.
- BUSY**—Excessive or competing detail.
- BUTTON BAR**—*Also called* TOOL BOX. A program specific legend of options available to a computer user.
-

Continued on next page

Glossary, Continued

C

CABINET PROJECTION—A type of oblique drawing with the angled receding lines drawn to one-half scale.

CALLOUT—To call attention to a part or item in an illustration.

CAMCORDER—A video camera and recorder in one unit.

CAMEO PAPER—Paper of a dull, smooth finish used frequently for carbon and graphite pencil drawings.

CAMERA LUCIDA—*Also called LACEY LUCY.* An instrument with prism lenses used for enlarging or reducing artwork.

CAMERA-READY COPY—See **REPRODUCTION COPY**.

CANVAS—A surface made of cloth, usually cotton or linen, for painting.

CANVAS BOARD—Cardboard covered with cotton or linen used as a surface for painting.

CANVASKIN—A paper with a textured surface resembling canvas.

CAPTION—Any descriptive heading or title for an illustration or table.

CARBON PENCIL—Pressed carbon in a wood casing.

CARICATURE—The deliberate exaggeration and distortion of prominent features or mannerisms.

CARPENTER'S PENCIL—A wide, flat lead pencil ideal for chisel point lettering or laying in broad tones.

CARTOON—A comic or satiric drawing.

CARTOUCHE—A scroll-like design used ornamentally in printing or hand lettering.

Continued on next page

Glossary, Continued

- C (Continued)** **CASEIN**—A curd of milk and lime used as a binder in tempura paint.
- CAVALIER PROJECTION**—A form of oblique drawing with the receding lines drawn full scale at 45° to the orthographic front view.
- CD**—See COMPACT DISK.
- CD ROM**—See COMPACT DISK READ-ONLY MEMORY.
- CEL**—Acetate overlays used in television art and animation.
- CEL LEVEL**—The number of cels placed one over another on the same background and photographed at the same time.
- CENTER DISK**—A drafting instrument that protects the paper surface from damage when drawing multiple concentric circles with a compass.
- CENTER OF INTEREST**—The part of the picture that attracts the most attention.
- CENTER LINE**—Lines that indicate the center consisting of alternating long and short dashed evenly spaced.
- CENTER SPREAD**—Two facing pages formed by one folded sheet of paper.
- CENTRAL PROCESSING UNIT**—*Also called CPU.* The integrated circuit (IC) chip that controls the speed and processing power of the computer.
- CHAIN or CIVIL ENGINEER'S SCALE**—A scale, generally triangular, divided in decimal units or units of 10.
- CHARACTER**—Any letter, number, punctuation mark, or space in printed matter.
-

Continued on next page

Glossary, Continued

- C (Continued)** **CHARACTER GENERATOR**—A computer hardware or software device that provides a means for formulating a character font and as a controlling function during printing.
- CHARCOAL**—Specially charred willow sticks used for drawing on a paper with tooth.
- CHARCOAL DRAWING**—A drawing made with charcoal.
- CHARCOAL PENCILS**—Charred willow sticks encased in wood for strength.
- CHIAROSCURO**—Rendering forms using a balanced contrast between pronounced light and dark elements.
- CHINESE WHITE**—An opaque white watercolor pigment.
- CHISEL POINT**—Drawing or lettering with a wide, flat point.
- CHOKES**—Used to trap a dark element over a light background to avoid or minimize white space showing around the element during press plates misalignment.
- CHROMA**—*See* INTENSITY.
- CIRCULAR SCREEN**—A photographic screen used with a process camera, which allows screen adjustment to eliminate the wavelike or checkered effect, called moire.
- CIRCUMFERENCE**—The length of a line that forms a circle.
- CIRCUMSCRIBED**—To draw around or enclose within one geometric form another form or object.
- CLICK ON**—To select a computer function by clicking the buttons on a mouse.
-

Continued on next page

Glossary, Continued

C (Continued)

CLIP ART—A collection of artwork filed away for future use.

CMYK—An acronym for cyan, magenta, yellow, and black, a color specification system for color separation and printing.

COATED PAPER—Paper coated with a finely ground filler or clay to produce a smooth surface.

COBALT DRIER—A liquid agent used in a medium to accelerate the drying of oil paints.

COLD COMPOSITION—Composition of type that uses no molten metal to form the image.

COLD MOUNT—A method of mounting artwork or photographs to a surface.

COLD PRESSED—A paper or illustration board with a medium to rough surface texture.

COLLAGE—Artwork made by arranging and pasting pieces of cloth, newspaper, and various other materials on a surface to form a composition.

COLLATING—Gathering single sheets or leaves in sequence.

COLLOTYPE—A method of reproducing paintings and drawings using a gelatin plate.

COLOR—A sensation caused by light waves of different lengths comprised of three elements: hue, value, and intensity.

COLOR BARS—Bars of color that appear on a video screen to facilitate fine tuning of the color resolution.

COLOR BLENDING—Blending or combining different colors to form another color or smooth gradient.

Continued on next page

Glossary, Continued

C (Continued)

COLOR CHART—An arrangement of colors.

COLOR CYCLING—A spectral effect that creates the illusion of movement on the computer screen.

COLOR DIMENSIONS—The three elements of color: hue, value, and intensity.

COLOR GRAPHICS ADAPTER BOARD—*Also called CGA or a Video Graphics Adapter (VGA).* This IC chip defines the ability of the computer to execute commands during the creation of artwork in the computer.

COLOR HARMONY—A unified or aesthetically pleasing effect produced by a combination of colors.

COLOR INTERVAL—The degree of visual difference between two colors as measured by hue, value, and intensity.

COLOR KEY—The overall effect of the selected palette; for instance, a high—key illustration of light, bright or vibrant color and a low—key illustration of dull or monotonous colors.

COLOR NOTATION—The specification of color by written symbols and numerals based on an established color system used on sketches for future reference.

COLOR PROOF—An engraver's or printer's proof showing the effect of final color in perfect registration.

COLOR SCALE—A series of colors that display a change or gradation in hue, value, and intensity.

COLOR SCHEME—A group of colors that dominate a picture or create a unity within it.

Continued on next page

Glossary, Continued

C (Continued) **COLOR SEPARATION**—(1) The photographic process of separating full-color originals into the primary printing colors; (2) An artist manually separating the originals for full color reproduction in the creation stage of a master artwork.

COLOR SKETCH—A rough drawing or layout approximating the color in the final picture.

COLOR SYMBOLISM—The use of color to signify or suggest an emotion, idea, or characteristic.

COLOR WHEEL—A circular color chart with colors arranged according to their positions as a primary, secondary, or tertiary color.

COLUMN—(1) A section of text or other matter that makes up a vertically divided page; (2) A vertical section of a table.

COMBINATION PLATE—A press plate that combines both halftones and line work.

COMIC STRIP—A series of drawings, in panel format, portraying the adventures of characters, humorous or otherwise, usually published in newspapers.

COMMERCIAL ART—Artwork of any kind prepared for commercial advertising and general promotion.

COMPACT DISK—*Also called CD.* A small disk of electronic files encased in a plastic casing.

COMPASS—An instrument for drawing circles and arcs.

COMPUTER DISPLAY MONITOR—An output device that allows the computer operator to see an image of electronic media on a cathode-ray screen similar to a television monitor.

Continued on next page

Glossary, Continued

- C (Continued)**
- COMPUTER PLATFORM**—The use of a particular brand of computer to develop software programs specifically for that brand.
- COMPLEMENTARY COLORS**—Any two opposing hues on a color wheel.
- COMPOSITE**—Comprised of two or more parts.
- COMPOSITION**—The arrangement of forms, colors, lines, and other pictorial units.
- COMPOSITOR**—A machine that converts electronic data into an acceptable format for a printer.
- COMPREHENSIVE**—A layout of art or type, either in black—and-white or color.
- COMPREHENSIVE SKETCH**—A finished layout that defines all of the elements, such as type, illustration, and spacing.
- COMPRESSED FILES**—Compacting computer—generated files to save disk and memory space or to facilitate faxing.
- COMPUTER GRAPHICS**—Artwork created by the use of a computer.
- CONSTRUCTION**—The drawing of objects so that they appear solid or three dimensional.
- CONSTRUCTION LINES**—Lightly drawn lines used in the preliminary layout of a drawing.
- CONTACT SCREEN**—A screen placed in direct contact with the film or plate to obtain a halftone pattern from a continuous—tone original.
- CONTINUOUS-TONE ART**—Artwork created using any medium that does not use a halftone process to represent tone.
-

Continued on next page

Glossary, Continued

- C (Continued)** **CONTOUR PEN**—Adjustable pen nibs on a rotatable shaft used for drawing curvilinear lines.
- CONTRAST**—The range of tonal differences.
- COOL COLOR**—Colors that appear to project cooler temperatures.
- COOLED COLOR**—A color resulting from the addition of a cool color to a warmer color.
- COPY**—Any matter, including photographs, rules, designs, and text, used for producing printed matter.
- COPYBOARD**—A table or frame that holds original copy during a photographic exposure.
- COPYFIT**—Scaling copy to fit into an allotted space.
- COPYRIGHT**—Exclusive protection of ownership given to a creator of an original work.
- COQUILLE BOARD**—A drawing board that comes in a variety of roughened surfaces that break up crayon or brush strokes into texture more suitable for line reproduction.
- COURSEWARE**—All materials pertaining to a software program or course of instruction.
- CPU**—See **CENTRAL PROCESSING UNIT**.
- CRAWL DEVICE**—A rotating drum used to display credit lines for television transmissions.
- CREMNITZ**—See **WHITE LEAD**.
- CROP**—To cut off.
-

Continued on next page

Glossary, Continued

- C (Continued)** **CROP MARKS**—Marks used to define the limits of an image for reproduction.
- CROPPING**—Defining the limits of an image for reproduction.
- CROSSHATCH**—Parallel lines drawn across other parallel lines to indicate tone.
- CROW QUILL**—A fine, stiff pen nib with little spring used for drawing fine lines and lettering.
- CRT**—*Also called* CATHODE-RAY TUBE. A screen or monitor that converts light rays to electrical impulses for transmission or receiving.
- CURE**—A solid form of six equal square sides.
- CURSOR**—A position indicator on a computer monitor.
- CUTAWAY DRAWING**—A drawing where a portion of the object is cut away revealing the internal structure.
- CUTLINE**—The placing of a caption in an illustration.
- CUTTING PLANE LINE**—A sectional view showing a theoretical cut on the item.
- CYAN**—Light blue-green color.
- CYCLE OF ACTION**—The completion of a single action of animated movement.

-
- D** **DAISY WHEEL PRINTER**—A spinning wheel with spokes having raised letters and numbers.
- DAMAR FINISH**—Varnish used as a final protective coat over a painting or mixed as part of the painting medium.
-

Continued on next page

Glossary, Continued

- D (Continued)** **DATA POINTS**—Symbols used to plot information or events on a graph or chart.
- DATUM LINE**—A line that indicates the position of a datum plane.
- DEADLINE**—Final delivery date.
- DEBUGGING**—Locating and eliminating software deficiencies.
- DECAL**—*See* DECALCOMANIA.
- DECALCOMANIA**—An image printed on specially prepared paper or film for transfer to another surface.
- DECKLE EDGE**—The rough or uneven edge of paper intentionally produced during manufacturing.
- DELINEATE**—To give depth to line art by making particular lines heavier.
- DENSITY RANGE**—*Also called* DENSITY SCALE. Measured differences between the minimum and maximum densities of a particular negative or positive.
- DEPICT**—To represent.
- DEPTH**—Thickness as measured downward from the surface of an object.
- DEPTH OF FIELD**—The distance between the closest sharply focused point to the farthest point in focus.
- DESCENDERS**—The parts of lowercase letters that fall below the main body base line, such as g, p, and q.
- DESIGN**—A planned or intended arrangement of the elements in a composition.
- DESIGNER'S COLORS**—Opaque watercolors of high quality.
-

Continued on next page

Glossary, Continued

- D (Continued)** **DESKTOP PUBLISHING**—The preparation of copy ready to go directly to press.
- DETAIL DRAWING**—A drawing that gives specific information.
- DETAIL PEN**—*Also called* SWEDE PEN. A broad nibbed, adjustable ruling pen with greater ink capacity than a standard ruling pen.
- DETAIL VIEW**—A view that shows part of the principal view of an item using the same plane and arrangement but in greater detail and in a larger scale.
- DEVELOPER**—A chemical that causes a reaction in an exposed emulsion to reveal an image in that emulsion.
- DIAZO FILM**—A flexible transparent base coated with an emulsion of diazo salts and couplers.
- DIAZO PAPER**—Paper treated with a diazo compound and azo dyestuff component.
- DIAZOCROME**—Diazo sensitized films that produce colored dye images on a transparent plastic base.
- DIFFUSED LIGHT**—Evenly spread light.
- DIMENSION LINE**—A thin, unbroken line with each end terminating in an arrowhead used to define the dimensions of an object.
- DIMETRIC PROJECTION**—An axonometric projection of an object where two axes make equal angles with the plane of projection and the third axis makes a smaller or larger angle with the plane of projection.
- DINGBATS**—Stars or ornaments used to embellish type.
- DISCHORD**—Color or elements that compete or are not in visual harmony and create uneasy or unattractive images.
-

Continued on next page

Glossary, Continued

- D (Continued)** **DISK**—*Also called DISC.* (1) A flat photomatrix used in phototypesetting and computer equipment; (2) A layer of magnetic oxide used to store electronic data.
- DISK DRIVE**—A device that reads, adds, or deletes information stored on a disk.
- DISPLAY LETTERING**—Any large, prominent lettering used to attract attention.
- DISPLAYS**—A collection of objects and images arranged to tell a story.
- DISPLAY TYPE**—Large type used for headings and titles.
- DISSOLVE**—The fading of one scene as another replaces it.
- DISSOLVE UNIT**—An electronic device that automatically pulses a slide projector to dissolve an image and replace it with another.
- DISTORTION**—Changed or twisted out of natural shape.
- DIVIDERS**—An instrument used for dividing lines into equal segments and transferring measurements.
- DOMINANT**—Prominent or most important.
- DOT MATRIX PRINTER**—A printer that uses a number of pins to form letters and numbers.
- DOTS PER INCH**—*Also called DPI.* A standard measurement for resolution in the computer graphics industry.
- DOUBLE-ACTION AIRBRUSH**—An airbrush that requires the user to push down a button to expel air through the brush and to pull back the button to release paint.
-

Continued on next page

Glossary, Continued

- D (Continued)** **DRAFTING MACHINE**—A machine that combines the functions of a T-square or straightedge, a triangle, a ruler, and a protractor.
- DRAWING**—The representation of objects, ideas, or emotions on a flat surface using line, tone, or color.
- DRAWING THROUGH**—Sketching in the structural lines of an object as if it were transparent.
- DRIER**—A substance used to hasten the drying times of paint or ink.
- DROP CARDS**—Drop-out or drop-in title cards rigged to fall in and out of camera view.
- DROP OUT**—Masked or opaqued areas present in the halftone negative, print, or plate.
- DROP-OUT HALFTONE**—A halftone reproduction that eliminates the screen dots in white areas, often accomplished photographically by the platemaker or by re-etching.
- DRY BRUSH**—Drawing or painting with a brush that contains very little substance to create a textural effect.
- DRY MOUNT**—Mounting photographs without paste or rubber cement.
- DRY MOUNT PRESS**—An electrically heated press that activates an adhesive sheet or foil placed between the image and the illustration board.
- DUCK**—A lead weight used to position a spline while drawing irregular curves.
- DUMMY**—A rough draft or proposal of printed material pasted or bound together in exact reproduction size that show the areas illustration and text will occupy.
- DUOTONE**—Two-color halftone print made from a screened photograph.
-

Continued on next page

Glossary, Continued

E

EARTH COLORS—Pigments made from earth minerals.

EDGE—The border or outline of a form or shape.

EDIT—To check, add, or delete.

EDIT CONTROLLER—A machine that locates the beginning and end of a scene used for cuing VCRs for presentation.

EGG-OIL TEMPERA—An opaque watercolor similar to egg-based tempura but with an added oil that makes the medium easier to handle and adaptable to a wider range of effects.

EGG TEMPURA—An opaque watercolor paint that uses egg yoke as a binder.

ELECTRONIC IMAGING—The creation, enhancement, and alteration of images through electronic or computer digitization.

ELEVATION—A four-view drawing of a structure showing front, sides, and rear.

ELITE—A type size for typewriters approximating 10 point printing type having 12 characters to the linear inch of copy and 6 lines to the vertical inch.

ELLIPSE—The enclosed plane forming a regular oval where the shortest dimension through the center is the minor axis and the longest dimension is the major axis.

EM—A measure of type equal to the square of the type body, derived from early type practices in which the letter *M* was cast on a square body.

EMPHASIS—Stress or accent on any part of a design or picture.

EMULSION—A suspension of fine drops or globules of one liquid in another liquid.

Continued on next page

Glossary, Continued

- E (Continued)** **EN**—A measure of type equal to one half of an EM.
- ENCRUSTING**—Taking a video image and wrapping it around an image of an object.
- ENGINEERING DRAWING**—An orthographic drawing of a piece of equipment or of its detailed parts containing information and instructions sufficient for manufacture.
- ENGINEER'S SCALE**—A scale used whenever dimensions are in feet and decimal parts of a foot, or when a scale ratio is a multiple of 10.
- ERASING SHIELD**—A small, thin spring metal plate with variously sized and shaped openings used to protect the surrounding area of a drawing while erasing in an adjacent area.
- ESSENTIAL AREA**—The part of a picture that contains all of the title or lettering intended for viewer consumption and often corresponding with the safe title area.
- EQUILATERAL**—Equal angles and equal sides.
- EXPLODED VIEW**—A pictorial view of a device in a state of disassembly, showing the appearance and interrelationship of parts.
- EXPOSURE INDEX**—The degree of light sensitivity of film.
- EXPORT**—The transfer of files to another software application.
- EXTENSION BAR**—A leg extension to a standard compass, which expands the diameter of a circle that the compass is able to draw.
- EXTENSION LINE**—A line used to indicate the extent of a dimension.
- EYE LEVEL**—*Also called HORIZON LINE.* The horizontal plane at the artist's eye level to which that person relates linear perspective.
-

Continued on next page

Glossary, Continued

F

FACE—*Also called TYPEFACE.* A style of type.

FADE-IN—To bring an image from a pale version into full contrast gradually.

FADE-OUT—To bring an image from a full contrast of darks and lights to a pale version gradually.

FEATHER—A bleeding effect where small featherlike indications surround the characters.

FEATURE—A cartoon panel or strip appearing regularly in a publication.

FELT NIB PEN—A drawing pen with a felt nib or tip that ink soaks through from a reservoir.

FERRULE—The part of a brush that holds the hairs or bristles.

FIGURE—A line illustration or photograph of any kind used in a publication.

FILLS—Color, shades, or patterns added to computer-generated imagery.

FILM NEGATIVE—A photolithographic negative produced by a process camera.

FILM POSITIVE—A film- or acetate-based material having a black area or image and a translucent or clear background.

FILM SPEED—The degree of light sensitivity of film.

FINE ART—The personal expression of the artist who creates it.

FINISHED ART—Any piece of artwork complete or ready for reproduction.

FINISH MARKS—Marks used to indicate the degree of smoothness of the finish on machined surfaces.

Continued on next page

Glossary, Continued

- F (Continued)** **FIRST GENERATION**—Photographically reproduced copy made from the original.
- FIX**—To spray with a clear coat to protect or preserve an image surface.
- FIXATIVE**—Any clear solution sprayed or coated on a surface to stabilize, protect, or preserve an image.
- FIXER**—A solution or chemical that stabilizes the development of photosensitized films.
- FLEXIBLE CURVE RULE**—A scale or rule that bends in shape to irregular curved surfaces.
- FLAKE WHITE**—*See* WHITE LEAD.
- FLANNEL BOARD**—*Also called* FELTBOARD. A presentation board covered in felt or flannel that cut out shapes backed with a slightly abrasive backing will cling to.
- FLAPPING**—*See* MOUNTING AND FLAPPING.
- FLAT BRUSH**—A flat oil painting brush that is thicker and with longer bristles than the bright brush.
- FLAT COLOR**—Color that is dull or grayed or has a matte surface.
- FLAT TONE**—An area of uniform or even color.
- FLIP CARD**—One of a series of photographs or drawings shown in sequence to tell a story or deliver a message.
- FLOP**—To reverse from right to left or vice versa.
- FLOPPY DISK**—A disk of magnetic oxide that stores electronic data for retrieval by a computer disk drive.
-

Continued on next page

Glossary, Continued

- F (Continued)** **FLOW CHART**—A chart that shows the flow of data through a data processing system and the sequence of their performance.
- FLOUROGRAPHIC** —*See* **DROP-OUT** **HALFTONE**.
- FLUSH**—Even with the margin or the widest line in a column or page.
- FOCAL POINT**—Center of interest.
- FOCAL LENGTH**—The distance from the center of the lens to the film plane.
- FOCI METHOD**—A method of drawing ellipses by plotting a series of points as their circumference using two points on the major axis (foci) as reference and connecting these points with french curves.
- FOCUS**—Image sharpness.
- FOLIO**—A sheet of paper folded once giving four pages.
- FONT**—Typeface designs and sizes.
- FORESHORTEN**—To depict an object or line in less than its true length.
- FORM**—The shape and structure of an object or figure.
- FORMAL BALANCE**—*See* **BALANCE** or **SYMMETRY**.
- FORMAT**—A general structure or composition.
- F/STOP**—Settings on the lens diaphragm of a camera lens that measure the amount of light allowed to reach the film.
- F/16 RULE**—Setting the camera for an f/stop of f/16 and the shutter speed close to the ASA/ISO rating of the film.
- FRAME**—A single unit in a storyboard, a cartoon feature, or a film strip.
-

Continued on next page

Glossary, Continued

- F (Continued)** **FRAME GRABBER**—*Also called VIDEO CAPTURE.* A device that isolates one frame of a video image and inputs this frame into a computer.
- FREEHAND DRAWING**—Drawing without the use of mechanical aids.
- FRENCH CURVES**—Instruments used to draw smooth, irregular curves.
- FRESCO**—Painting on freshly spread, moist plaster with pigments.
- FRESNEL LENS**—A intense prismatic lens of concentric divisions, which concentrate and focus light through a transparent image onto a mirror and to a screen in an overhead projector.
- FRISKET**—A covering placed over part of a drawing or photograph to protect that section while working on the rest of the artwork.
- FRONTISPIECE**—An illustration preceding and usually facing the title page of a book.
- FULL-COLOR PAINTING**—A painting in which the three primary colors or some variation of them is evident.
- FULL MEASURE**—The entire width of a line of type flush with both margins measured in picas.
- FULL SECTION**—A sectional view that passes entirely through the object.
- FULLERS EARTH**—A fine white powder used for preparing the surface of a photograph to accept retouching.

-
- G** **GALLEY PROOF**—A rough proof of type made for proofreading, submitted before pages are made up.
- GANG RUN**—Several different jobs printed simultaneously on a large press in the same colors on one sheet to save time and reduce costs.
-

Continued on next page

Glossary, Continued

- G (Continued)** **GANG SHOOTING**—Photographing several pages of original copy at the same time.
- GELATIN**—A pure glue made from animal or vegetable matter.
- GENERATION**—A single step in a reproduction process.
- GIGABYTE**—Approximately one billion bytes of information, a kilobyte to the third power (1,024 x 1,024 x 1,024).
- GLAZE**—An application of a transparent color or value over another color or value.
- GLOSSY PRINT**—A print having a shiny finish, which does not readily absorb inks or paints.
- GLYCERIN**—A heavy oil, colorless and odorless, used in the preparation of watercolor pigment.
- GOLDENROD**—Paper or plastic mask material used to support negatives in making press plates.
- GOTHIC**—An alphabet or typeface characterized by strokes of equal or almost equal thickness, usually without serifs.
- GOUACHE**—An opaque watercolor.
- GRADED WASH**—A wash that blends a light tone to a dark tone or vice versa.
- GRADUATED FILL**—To fill with color, shade, or pattern that variegates from dark to light or vice versa.
- GRAPHIC ARTS**—A form of art specializing in work prepared primarily for conveying information.
-

Continued on next page

Glossary, Continued

- G (Continued)** **GRAPHIC INTERFACE**—Screen graphics on the computer screen that make the computer easier to use.
- GRAPHICS PRINTER**—A high-resolution printer capable of printing graphic images.
- GRAPHICS TABLET**—An electronic input device that allows the user to draw on the tablet before committing the image to memory.
- GRAPHITE**—The black marking substance in a lead pencil.
- GRAVER**—A needle or square pointed tool used to scratch lines into scratchboard.
- GRAVURE**—A photomechanical printing process (intaglio) with the images recessed below the surface of the plate.
- GRAY**—A color formed by mixing black and white or complementary colors.
- GRISAILLE**—A decorative gray monochromatic painting designed to create the illusion of a bias—relief sculpture.
- GUM ARABIC**—A water soluble gum used as a binder in some watercolors and tempura paints.
- GUTTER**—(1) The inner margin of a printed page extending from the printed portion to the fold or binding; (2) The area between two columns on a printed page.

-
- H** **HALF SECTION**—A combination of an orthographic projection and a section view to show two halves of a symmetrical object.
- HALFTONE**—A tonal pattern of shades from white through black defined by a series of dots.
-

Continued on next page

Glossary, Continued

- H (Continued)** **HALFTONE SCREEN**—A screen placed in front of the negative material in a process camera to break up a continuous-tone image into a dot formation.
- HARD COPY**—Copy of any kind produced on paper or any substrate except film, used for proofing, checking, revising, or redrawing.
- HARMONY**—A pleasing arrangement of the picture elements, because of the similarity of one or more qualities.
- HEXAGON**—A six-sided figure.
- HIDDEN LINE**—Thick, short dashed lines used to show a hidden part or edge.
- HIGHLIGHT HALFTONE.**—*See* DROP-OUT HALFTONE.
- HIGH SURFACE**—*See* HOT PRESSED.
- HINGE JOINT**—A joint limited to back-and-forth movement.
- HOLDING LINE**—A line usually drawn in black on a mechanical intended for reproduction.
- HOOK AND LOOP BOARD**—A briefing board covered with nylon hook material to which items backed with a nylon loop material will stick.
- HORIZON LINE**—An imaginary horizontal line representing the observer's line of sight.
- HOT PRESSED**—*Also called* HIGH SURFACE. A smooth art paper or illustration board.
- HUE**—The name given to distinguish any color.
- HYPO**—*See* SODIUM THIOSULFATE.
-

Continued on next page

Glossary, Continued

I

ICON—Onscreen computer symbols that portray functions by graphic images.

ILLUMINATION—The hand decoration of text in a book, a manuscript, or a diploma.

ILLUSTRATION—A picture designed to interpret a story or an article.

ILLUSTRATION BOARD—Heavy paper board manufactured especially for artists available in a variety of sizes, surfaces, and weights.

IMAGE AREA—An area that encompasses a printed, drawn, or photographed image and the light or dark background space around the image.

IMPORT—The transfer of files from other software applications.

INDEFINITE BLENDING—Adding paint or ink to a wet surface to promote indefinite effects.

INDIA INK—Pigment made of lampblack and a binder suspended in water as a fluid ink.

INFINITY—The farthest distance marking on a lens.

INFORMAL BALANCE—*See* BALANCE.

INK JET PRINTER—A high-resolution printer that uses a minute jet spray of ink to create an image.

INPUT—Text or parameters entered into a computer memory or saved on disk.

INPUT DEVICE—*See* KEYBOARD or JOYSTICK. An accessory used to provide text or commands into a computer or disk.

INSCRIBED—An object completely enclosed by another.

Continued on next page

Glossary, Continued

- I (Continued)**
- INTAGLIO**—Printmaking from engraved or etched lines and surfaces.
- INTENSITY**—The degree of strength, saturation, or purity of a color.
- INTERFACE**—Interaction between accessories.
- INTERMEDIATE**—A copy of an original on translucent or transparentized film, paper, or cloth, which now becomes a master to make other copies.
- IRREGULAR CURVES**—Curvilinear forms that do not contain arcs easily replicated by a compass or circle template.
- ISOMETRIC PROJECTION**—A set of three or more views of an object that appears rotated, giving the appearance of viewing the object from one corner.
- ITALICS**—Letters whose form has an oblique slant to the right or left.
- IVORY BLACK**—A fine black pigment.
-

- J**
- JOYSTICK**—*See* TRACKBALL or MOUSE. A computer input device used for remote manipulation of a cursor.
- JUSTIFICATION**—Spacing within the line of type of a predetermined measure to align the margins.
- JUXTAPOSITION**—Side-by-side placement for a desired effect.
-

- K**
- KERN**—Part of a letter that appears as a hairline connection between adjacent letters.
- KERNING**—The addition of space between characters.
- KEY**—A scale of values, tones, or hues.
- KEY ART**—*See* BLACK ART.
-

Continued on next page

Glossary, Continued

- K (Continued)** **KEY LINE**—A line drawn in red on a mechanical to indicate position and size of a piece of copy that will not be visible in the reproduction.
- KEYBOARD**—A computer input device based on the principle of a typewriter keyboard used to input text and commands into a computer.
- KEystone EFFECT**—Onscreen distortion created when the projector is not parallel to the deck or screen surface.
- KID FINISH**—A medium-textured surface of art paper or illustration board.
- KILOBYTE**—Abbreviated as K, a kilobyte is 1,024 bytes of data.
-
- LAMINATE**—(1) A transparent plastic or acrylic cover material; (2) To cover a surface with a transparent plastic or acrylic material.
- LAMINATION**—A plastic or acrylic used to cover a surface.
- LAMPBLACK**—A very fine black pigment used in various black paints and inks.
- LASER**—An acronym for Light Amplification by Stimulated Emission of Radiation.
- LASER PRINTER**—A high-resolution printer that uses laser technology to create an image.
- LAYING IN**—The initial broad application of tone to a picture.
- LAYOUT**—The arrangement of a book, a magazine, or other publication so that text and illustrations follow a desired format.
- LEADING**—Spacing between lines of type, measured in points.
- LEADER LINE**—Thin, unbroken lines used to connect numbers, references, or notes to appropriate surfaces.
-

Continued on next page

Glossary, Continued

L (Continued)

LEAF—A single sheet that includes both sides.

LEAK—An accidental escape of fill color or texture from an object or shape not completely enclosed by pixels.

LENS—Optical glass components arranged in a formation that creates a focal point at a specific distance from a screen.

LENS DIAPHRAGM—Controls the amount of light allowed to reach the film.

LEGEND—A description of any special or unusual marks, symbols, or line connections.

LENTICULAR SCREEN—A projection screen with a surface patterned to reflect a projected image with minimum glare.

LETTERHEAD—(1) The printed matter, usually the name and address of a company, at the head of a sheet of letter-quality paper; (2) A sheet of paper bearing a letterhead.

LETTERING—Letters and words formed or printed by hand.

LETTERPRESS PRINTING—A printing process in which the raised, inked surfaces of the type and/or plates transfer an impression directly to the paper.

LETTER-QUALITY PRINTER—A printer that imitates letters with resolution similar to a typewriter.

LETTERS PACING—Placing additional space between the letters of words to expand the length of a line or to improve and balance typography.

LIFT METHOD—(1) The process of using laminate material to remove or lift an image from clay-coated stock; (2) scanning text or graphics onto disk for importation to another application.

Continued on next page

Glossary, Continued

- L (Continued)** **LIGHT BOX**—A box with a translucent glass or plexiglass top illuminated from underneath, used for tracing and layout.
- LIGHTFACE**—The lightest and thinnest form of a type series.
- LIGHT PEN**—An electronic input device used to draw freehand against a CRT screen.
- LIMITED PALETTE**—(1) A palette with a restricted number of pigments; (2) A palette that lacks one or more of the three primary colors.
- LINE**—A continuous, unbroken mark made by a pen, a pencil, a brush, or other drawing instrument.
- LINE AND WASH**—A technique combining a black line with transparent wash.
- LINE COPY**—A composition of black lines and masses without gradation of tone.
- LINE DRAWING**—A drawing composed entirely of lines, dots, and areas of solid black.
- LINE OF DIRECTION**—The line the eye follows when looking at the picture.
- LINES PER INCH**—*Also called* LPI. A standard measurement of resolution for the color printing trade.
- LINE WEIGHT**—The thickness of pencil, ink, or other lines in artwork.
- LINSEED OIL**—An oil obtained by pressing the seeds of a plant, which produces linen fiber used as a medium in oil painting.

Continued on next page

Glossary, Continued

L (Continued) **LITHOGRAPHY**—*See* OFFSET PRINTING or OFFSET LITHOGRAPHY. A reproduction process in which grease crayon lines and masses drawn on a flat, polished stone print through the affinity of grease to grease (grease crayon and printer's ink). The wetted stone repels the ink from the other areas not covered with crayon.

LITHOGRAPHIC PENCILS—An oily pencil or crayon used to mark lithographic plates.

LOCAL COLOR—The actual color of an object without regard to the effect of changing light and shadow conditions.

LOCAL COLOR VALUE—The actual lightness or darkness of a color without regard to the effect of changing light and shadow conditions.

LOGOTYPE—*Also called* LOGO. The lettered signature, nameplate, or trademark of a commercial firm.

LONGSHOT—A picture showing a full figure or a distant view.

LACEY LUCY—*See* CAMERA LUCIDA.

M **MACHINE COMPOSITION**—Type set by a machine.

MACRO LENS—A short focal-length lens specifically designed to allow closeup photography.

MAHLSTICK—A rod used in the palette hand to support or steady the painting hand.

MAKEUP—*See* LAYOUT. The arrangement of text and illustrations on a page in conformance to standard practices in the industry or to publication requirements.

MAGNETIC CHALKBOARD—A briefing board that accepts chalk markings and magnetic attachments.

Continued on next page

Glossary, Continued

M (Continued) **MARS COLORS**—Artificial earth colors.

MASKING—To block out a portion of an illustration by pasting paper over it to prevent it from reproducing.

MASKING TAPE—An opaque, paper tape used to cover the edges of a picture while painting and to fasten artwork temporarily to a drawing board.

MASTER—An original typed, drawn, or typeset copy intended for reproduction.

MAT—A cardboard or paper decorative enclosure around a picture.

MATCH DISSOLVE—Holding one element on a screen as one scene dissolves into another.

MATTE—Dull or without shine.

MATTE PRINT—A print having a dull finish.

MATTE SCREEN—A projection screen with a dull surface to reduce glare from overhead lights.

MEASURE—The length of a line of type measured in picas.

MEATBALL—*See* BULLET.

MEDIA INTEGRATION—*Also called* MULTIMEDIA. Mixing various presentation devices in the same presentation.

MECHANICAL—A page or layout prepared as an original for photomechanical reproduction.

MECHANICAL DRAWING—A method of drawing using precision tools to produce mathematically precise layouts, diagrams, and engineering drawings.

Continued on next page

Glossary, Continued

- M (Continued)** **MEDIUM**—(1) A liquid that dilutes a paint without damaging its adhesive; (2) The mode of expression employed; (3) The actual instrument or material used by the artist.
- MEGABYTE**—Abbreviated MB or M, approximately one million bytes of data.
- MEMORY**—That portion of computer hardware that retains data for later retrieval.
- MENU**—A selection of options displayed on a computer screen.
- MICROCOMPUTER**—Another name for a personal computer or computer workstation not attached to a mainframe system.
- MILITARY STANDARDS**—*Also called MIL—STD.* A formalized set of government standards.
- MIXED MEDIUM**—*Also called MIXED MEDIA.* A combination of two or more mediums.
- MODEM**—An electronic input/output device that connects computer workstations for communications. An acronym for the word modulator and demodulator.
- MOIRÉ**—An wavy or checkered pattern that results when photographing a halftone through a screen.
- MONOCHROMATIC**—Shades or tints of one color.
- MONTAGE**—*See COMPOSITE.* (1) Arranging a number of pictures or designs in a combination, often with some overlapping, so that they form a composite whole; (2) The resultant arrangement or composition.
- MONITOR**—The viewing screen of a computer system.
- MOOD**—An outward projection of a feeling or emotion that affects behavior communicated by action, situations, or symbology in a picture.

Continued on next page

Glossary, Continued

M (Continued) **MORGUE**—*See* PICTURE MORGUE, CLIP ART, or RESEARCH FILE.

MOUNT—To fasten onto another surface.

MOUNTING AND FLAPPING—Fastening original artwork or copy to a board allowing sufficient excess around the picture borders to accommodate attaching a protective overlay along one side.

MOUNTING BOARD—Heavy paper boards used as backboards to support drawings, paintings, and photographs.

MOUSE—A hand-held computer input device that allows rapid movement and selection.

MULTIMEDIA—*Also called* MEDIA INTEGRATION. A combination of presentation devices used in the same presentation.

MULTIPURPOSE BOARD—A briefing board with a slick, bright, white surface that accepts erasable marker, marker, and magnetic backed accessories.

MUNSELL COLOR SYSTEM—A system of color analysis and identification that distinguishes between the three measurable dimensions of hue, value, and chroma (intensity).

MURAL—Any picture painted or fixed permanently on a wall or ceiling.

MYLAR—Tough, highly stable, polyester film used as a base for engineering drawings, laminating, overlays, and a wide variety of other applications.

N **NARRATION**—*Also called* VOICE OVER. The description or commentary that accompanies television and video presentations.

NCR PAPER—No Carbon Required paper; chemically coated paper that transfers a copy of an image to the sheet directly behind it without the use of a carbon.

Continued on next page

Glossary, Continued

- N (Continued)** **NEGATIVE, PHOTOLITHOGRAPHIC**—A film negative having a translucent image and a black background produced by a process camera and used primarily to make printing plates..
- NEUTRAL COLOR**—(1) A color that lacks hue and intensity; (2) A color that contains some amount of its complementary; (3) An earth color.
- NIB**—A point at the end of a pen or marker.
- NOISE**—Adding a random pattern of pixels over an image to add texture, create a new value, or give a painterly effect.
- NORMAL LENS**—*Also called* STANDARD LENS. A 50mm focal—length lens, which most closely approximates normal vision with minimal distortion.
-
- O** **OBLIQUE PROJECTION**—A view produced when the projectors are at an angle to the plane of the object illustrated.
- OCTAGON**—A figure having eight sides.
- OFFSET LITHOGRAPHY**—*See* LITHOGRAPHY. Lithographic printing where an inked plate prints on a rubber blanket, which then offsets the image to paper stock.
- OFFSET SECTION**—A section view of two or more planes in an object to show features that do not lie in the same plane.
- OIL PAINT**—Any pigment ground in linseed oil or poppy oil.
- OILSTONE**—A stone or abrasive used to sharpen needlepoints and blades.
- ONE POINT PERSPECTIVE**—*Also called* PARALLEL PERSPECTIVE. When the height and width of an object are parallel to the plane of projection.
- ONION SKIN**—*Also called* MANIFOLD PAPER. Thin, translucent paper used to make a typewriter carbon copy or to serve as a tissue overlay for work requiring correction or protection.
-

Continued on next page

Glossary, Continued

- O (Continued)** **ONSCREEN**—An image that appears on the computer or television screen.
- OPAQUE**—(1) Impermeable to light; not transparent or translucent; (2) To paint over unwanted portions of a negative with a solution to prevent light from seeping through.
- OPAQUE PROJECTOR**—A device that projects an opaque object to a desired size on another surface.
- OPAQUE WATERCOLOR**—*See* WATERCOLOR. A creamy, opaque paint—like gouache or tempura, available in tubes, jars, or by mixing white with transparent colors.
- OPAQUING**—Covering up with opaque paint.
- OPTICAL CENTER**—A point slightly above (10%) the geometric center of a layout that the eye perceives as the center.
- OPTICAL ILLUSION**—An unreal or misleading image perceived by the eye as real.
- OPTICAL SPACING**—The arrangement of spacing between letters for legibility and appearance, which varies with the shape of the letters to achieve optical equalization.
- ORGANIZATION CHART**—A block chart or diagram showing the names, titles, departments, and responsibilities of personnel in an organization.
- ORIGINAL**—*See* MASTER. Copy submitted to the printer for reproduction.
- ORTHOGRAPHIC PROJECTION**—A method of projection with six principal views.
- OSCILLATING AIRBRUSH**—An airbrush with a reciprocating needle used for fine detailed work.
-

Continued on next page

Glossary, Continued

O (Continued) **OUTPUT**—The end product generated by an electronic device, such as a computer, printer, or copier.

OUTPUT DEVICE—An electronic accessory to a computer system that provides some type of end product either visually or as a hard copy.

OUTLINE—The outside edge of a shape or form.

OUTLINE DRAWING—A drawing where lines define the outer limits of the forms without the representation of modeling, light, or shadow.

OVERHEAD PROJECTION—A projector that uses of a system of mirrors and a fresnel lens to project a transparent image or object to another surface or screen.

OVERLAP—To cover a part of one shape or line with another.

OVERLAY—A transparent or translucent sheet taped over the original art for protection or to indicate instructions or corrections.

OVERPRINTING—Printing an image over another impression.

OZALID MACHINE—An ammonia process printmaking machine that produces the same-size copy from transparent or translucent originals.

P **PAINTING KNIFE**—*See* PALETTE KNIFE. A type of palette knife made for applying paint to a picture.

PALETTE—(1) The surface on which the artist places paint and mixes colors before applying them to canvas or other painting surface; (2) A group of colors or gray values chosen for use in the same picture.

PALETTE KNIFE—A thin, flexible, steel blade set in a wooden or plastic handle available in a variety of shapes used for mixing paints and impasto, applying paint directly to a canvas or to create special textures directly on the surface of a picture.

Continued on next page

Glossary, Continued

- P (Continued)** **PALETTING**—Moving the pigment back and forth across a palette with a paint brush to achieve a certain consistency in texture or color or to load the brush with pigment adequately.
- PANEL**—(1) A given area in which a cartoon is drawn, with or without a defined frame; (2) One box or frame of a comic strip; (3) One unit of a storyboard.
- PANORAMA**—*Also called PAN.* Slow, steady camera movement from side to side.
- PANTOGRAPH**—A mechanical device based on the shape of a parallelogram, used to reduce, enlarge, or copy pictures.
- PANTONE COLOR SYSTEM**—An industry accepted system of color analysis and identification which distinguishes between the three measurable dimensions of hue, value, and chroma (intensity).
- PARABOLIC REFLECTORS**—Lamp reflectors that assist even illumination and shorten exposure time.
- PARALLAX**—Distortion present when exposing film through a lens not aligned with the viewfinder, distortion corrected by a rangefinder camera.
- PARALLEL PROJECTION**—*See ONE POINT PERSPECTIVE.*
- PARALLEL STRAIGHTEDGE**—A long, straight edge supported at both ends to maintain parallel motion.
- PARTIAL SECTION**—A sectional view consisting of less than a half section.
- PASTEL**—(1) A dry pigment mixed with a variety of binders to form a stick or crayon for application to a picture surface; (2) A picture executed in the pastel medium.
-

Continued on next page

Glossary, Continued

- P (Continued)** **PASTE-UP**—The process of pasting an image or part of an image on a reproduction page or sheet before photographing for platemaking or printing.
- PATTERN**—(1) The regular or irregular distribution or arrangement of elements; (2) Regularly repeated flat designs used to create two—dimensional textures.
- PENS, PLOTTER**—A pen nib or jet spray attached to a plotter output device.
- PENS, STEEL BRUSH**—Steel pen nibs designed to create large poster size lettering.
- PENS, TECHNICAL**—Conical or tubular tipped pen nibs designed to produce a consistently even line of a predetermined weight in a standard or metric measurement available with and without a reservoir.
- PENTAGON**—A five-sided figure generally having equal sides and angles.
- PERCENTAGE CHART**—*Also called* **PIE CHART**. A circular chart divided into wedges whose sum equals 100% or 360°.
- PERPENDICULAR**—A vertical line meeting or intersecting a horizontal line at 90°.
- PERSONIFICATION**—Attributing human qualities to animals or inanimate objects.
- PERSPECTIVE**—The visual impression of lines moving closer together as distance increases.
- PHANTOM LINES**—*Also called* **ALTERNATE POSITION LINES**. Lines consisting of one long and two short dashes, evenly spaced, terminating in a long line, used to indicate an additional position of a part or object.
-

Continued on next page

Glossary, Continued

- P (Continued)** **PHANTOM VIEW**—A view showing an alternate position of a movable object.
- PHOTOGRAPHIC TYPESETTERS**—*See* **TYPESETTERS, PHOTOGRAPHIC.**
- PHOTOLETTERING**—A method of simulating hand lettering or display type by photographic means.
- PHOTOLITHOGRAPHY** —The transferring of a drawing to a lithographic plate by photography.
- PHOTOMECHANICAL** —Pertaining to any process of printing or duplicating images by mechanical means from a photographically prepared printing plate.
- PHOTOSTAT**—*Also called* **STAT.** A photographic image recorded by a camera so constructed that it photographs and develops directly on paper, in negative values.
- PHOTOTYPE**—Type set by photographic means.
- PICA**—A unit of measure equal to 12 points or 1/6 of an inch.
- PICKUP**—A square of gum rubber used to remove excess rubber cement.
- PICTORIAL DRAWING**—Any drawing that depicts an object with recognizable clarity.
- PICTURE AREA**—The flat surface within the borders of a picture.
- PICTURE MORGUE**—*Also called* **MORGUE.** See **CLIP ART.**
- PICTURE PLANE**—An imaginary plane placed between the observer and the object, usually at right angles to an observer's line of vision.
- PIE CHART**—*See* **PERCENTAGE CHART.**
-

Continued on next page

Glossary, Continued

- P (Continued)** **PIGMENT**—Dry color matter that becomes paint when mixed with a vehicle or binder.
- PINHOLE**—A small light spot that appears on a developed photographic negative resulting from particles of dust and lint on the unexposed negative, the camera lens, the vacuum board glass, or other parts of the camera.
- PIN REGISTER**—A method of holding elements in place in overlay work and animation.
- PIXEL**—*Also called* PICTURE ELEMENT. A small bit of digital data from a computer screen.
- PIXEL MAP**—*Also called* BIT MAP. A matrix of pixels that form a digital image on the computer screen.
- PIXILATED**—Having jagged edges.
- PIXEL**—Specifying the size of a pixel on the computer screen.
- PLAIN TITLE CARD**—Printed information only on a card for television transmission of credit lines.
- PLAN VIEW**—A view of an object or area as it would appear if viewed from directly above.
- PLANE**—A flat surface.
- PLANNING CARDS**—A small card containing a idea or point placed in sequence on a storyboard.
- PLAT**—A map or plan view of a lot showing principal features, boundaries, and location of structures.
- PLATE FINISH**—A smooth surfaced paper.
- PLY**—A single layer of drawing paper.
-

Continued on next page

Glossary, Continued

- P (Continued)** **POINT**—A standard type measure of 1/72 of an inch or 72 points equals 6 picas.
- POLYMER**—Paints that have polyvinyl acetate or acrylic resin as a binder used as either a transparent or opaque medium.
- POLYGON**—Common geometric constructions.
- PORTRAITURE**—The process or art of depicting an individual by drawing, painting, or photographing from life.
- PORTRAY**—To delineate or depict.
- POSTER**—A large cardboard or paper display sign.
- POSTER BOARD**—A medium weight cardboard suitable for show cards.
- POSTER COLOR**—An opaque watercolor used for making show cards.
- POSTERIZATION**—A technique for adding poster—like qualities to a photograph, a film, or an illustration by separating the normal tones of a subject into distinctly separated, strong tones.
- POUNCE**—A powdered substance that improves the ink—absorbing qualities of tracing cloths and papers.
- PRELIMINARY DRAWINGS**—Drawings done in preparation for a finished piece of art.
- PRE-PRESS**—The preparatory stage of art or copy immediately before committing the image to a plate.
- PRIMARY COLORS**—The red, yellow, and blue in a subtractive process and the red, yellow, and green in the additive process of color theory.
- PRINT**—An image made from a master negative or plate.
-

Continued on next page

Glossary, Continued

P (Continued)

PRINTING—A process for reproducing copy.

PRINTING PLATE—*Also called CUT.* A flat piece of metal used on a printing press that contains the image either engraved or etched photographically on the surface.

PRISM—A transparent piece of crystal or optical glass having two plane surfaces which are not parallel that separate white light into the visible colors of the spectrum.

PROCESS COLOR REPRODUCTION—A combination of halftone plates, usually red, yellow, blue, and black, which when printed in perfect register, combine to produce a full—color reproduction.

PRODUCTION DEPARTMENT—The people responsible for purchasing and maintaining schedules on printing, typography, engravings, bindings, paper, and sometimes the purchase of art for an organization.

PROGRESSIVE PROOFS—Proofs showing the order of printing and shade of ink for each required plate.

PROGRESSIVE DISCLOSURE—Systematically revealing information on a partially obscured visual.

PROJECTION—The act or art of projecting lines-and planes in orthographic and perspective drawings.

PROJECTOR—A device containing a light and lenses for projecting an image onto another surface.

PROJECTURAL—(1) An image projected onto another surface; (2) The image so projected.

PROOF—A printed impression from a negative, a plate, or a body of type submitted for examination or correction.

Continued on next page

Glossary, Continued

P (Continued) **PROOFREADER'S MARKS**—Standard marks placed in the margin nearest the word that indicate corrections in typeset copy.

PROPORTION—The relation to size of one part or thing to another or one portion of something to the whole.

PROPORTIONAL DIVIDERS—A drafting instrument used for transferring measurements from one scale to another or to divide lines and circles into equal parts.

PROPORTIONAL SPACING—*Also called* DIFFERENTIAL LETTERSPACING. The spacing of characters in proportion to size by means of the typewriters and office composing machines used in the preparation of cold composition copy.

PROPS—Accents or accessories that identify the time frame or location of a subject.

PROTRACTOR—A circular or semicircular rule for measuring off the degree of an angle.

Q **QUILL PEN**—*See* CROW QUILL. A pen nib made from a feature quill.

R **RADIAL FILL**—To fill an object with color, pattern, or shade that appears to radiate from the center of the object.

RADIATION—A divergence of lines, tones, or colors from a common point to different directions.

RADIUS—A straight line from the center of a circle or sphere to a point on its circumference.

RADIUS CURVE—A drawing tool used to draw arcs of a predetermined radius.

Continued on next page

Glossary, Continued

- R (Continued)** **RANDOM ACCESS MEMORY**—*Also called* RAM. Retrievable computer memory accessible at will without sequential reading.
- RANGEFINDER**—The ground glass in a camera used to focus an image.
- RASTER-BASED**—An image based on the manipulation of a matrix of pixels or dots.
- RASTER IMAGE PROCESSOR**—*Also called* RIP. A device for converting vector—based imagery to high—resolution raster images.
- READ**—To access electronically stored data.
- REAR PROJECTION SCREEN**—A matte surface, translucent screen used when projecting an image from behind to a screen.
- REBOOT**—Restart the computer system.
- RECEDING COLORS**—Colors that appear to move away or create the illusion of distance.
- RECTANGULAR COORDINATE GRAPH**—A graph based on a grid system where values are plotted by X and Y coordinates.
- REFERENCE NUMBERS**—Numbers used on one drawing to refer to another drawing for further details.
- REFERENCE PLANE**—The normal plane used to reference all information.
- REGISTER**—To align a page or any elements of an image or impression to match the position of successive impressions.
- REGISTER MARKS**—Marks used to key an overlay to a drawing or mechanical as in color separation or combination plates.
- REMOVED SECTION**—A drawing of the internal cross section of an object located near the basic drawing of the object.
-

Continued on next page

Glossary, Continued

- R (Continued)** **RENDER**—To represent, portray, or depict in a drawing or painting.
- RENDERING**—A drawing or painting in which tonal values vary from white through black or from light to dark shades.
- REPRODUCIBILITY**—The ability of line and halftone copy to reproduce as acceptable and legible.
- REPRODUCIBLE ART**—Second-generation art made from the original art and mortised or pasted onto the reproduction page.
- REPRODUCTION**—Making one or more copies of an original piece of work.
- REPRODUCTION COPY**—*Also called* CAMERA-READY COPY. Copy ready in all respects for photomechanical reproduction.
- REPRODUCTION PROOFS**—*Also called* REPROS. Exceptionally clean, sharp proofs on a highly coated paper used for reproduction.
- REPROGRAPHICS**—The reproduction of images by copying machines and their methods and processes.
- RESCALE**—To enlarge or reduce in size or to change in shape without changing proportion to fit new space configurations.
- RESEARCH FILE**—See MORGUE, PICTURE MORGUE, or CLIP ART.
- RESOLUTION**—Clarity, focus, or density.
- RETOUCH**—To delete unwanted image areas or make repairs to copy by painting out with an opaque solution.
- RETOUCH GRAYS**—A series of opaque watercolors ranging from white to black.
-

Continued on next page

Glossary, Continued

- R (Continued)** **RETOUCHING**—The alteration of detail or removal of spots and blemishes in a photographic print or negative.
- RETOUCH VARNISH**—A light, colorless varnish sprayed on a dull, dried-out area or an unfinished oil painting to restore the “wet” colors or values, making it easier to mate with new paint.
- REVERSE**—*See* FLOP. To turn over.
- REVERSAL**—*See* REVERSE PRINT.
- REVERSE PRINT**—A print where the black values of the originals are white.
- REVISION BLOCK**—Space located in the upper-right corner of a drawing to record any changes to the original drawing.
- REVOLVED SECTION**—A drawing of the internal cross section of an object superimposed on the basic drawing of the object.
- ROMAN**—One of a group of alphabets or typefaces characterized by thick and thin strokes and often with serifs.
- ROSS BOARD**—An illustration board that comes in a variety of roughened surfaces that divide crayon or brush strokes into broken textures suitable for reproduction.
- ROTATION**—A view in which the object is rotated or turned to reveal a different plane or aspect.
- ROUND BRUSH**—A cylindrical brush having an evenly tapered point.
- RUBBER CEMENT**—Semitransparent glue consisting of gum rubber and a petroleum or benzol solvent.
- RUB-ONS**—Transfer sheets containing reprinted characters, symbols, and numerals applied by burnishing over an acetate or paper back sheet.
-

Continued on next page

Glossary, Continued

R (Continued) **RULING PEN**—An instrument that holds ink between two adjustable blades.

RUNNING HEAD—The title repeated at the top of consecutive pages in a book or magazine.

SABLE BRUSH—A flat or round-shaped brush made from the tail hair of a Kolinsky (Asiatic) mink.

SAFELIGHT—A colored light used to illuminate a darkroom without harming photosensitive film or paper.

SANDPAPER PAD—A pad of sandpaper sheets mounted on a strip of wood used to sharpen a pencil lead or pastel.

SANS SERIF—Without serifs, a letter that does not have a finishing stroke.

SATURATION—The purity or intensity of color.

SCALE—(1) Proportions or relative dimensions; (2) To enlarge or reduce without changing the original proportions.

SCALE CLIP—A clip attached to a scale that focuses on the scale currently in use.

SCALE DRAWING—A drawing that shows relative sizes and proportions.

SCALING—*Also called* DIMENSIONING or SIZING. Enlarging or reducing copy or an image to the correct dimensions to occupy a given area.

SCANNING AREA—The total area or picture that the camera sees.

SCRAP FILE—*See* RESEARCH FILE.

SCRATCHBOARD—A type of illustration board with a chalky surface uniformly covered with ink.

Continued on next page

Glossary, Continued

- S (Continued)** **SCREEN**—A glass plate or film with crosshatched lines that photographically produces a halftone for reproduction from a continuous—tone original.
- SCREEN PROCESS PRINTING**—*Also called SILKSCREEN.* A form of stencil printing that uses silk, nylon, or metal screen to contain the image.
- SCREEN REFRESH**—A continuous update of computations that create the image on a computer screen.
- SCRIPT**—(1) Lettering based on hand writing; (2) A paper or papers that describe in detail all of the elements of a commercial or story.
- SCROLL**—A rapid up-or-down movement of a computer screen image during a search function.
- SECONDARY COLORS**—The colors (orange, green, and violet) that lie halfway between the three primary colors.
- SECTION LINE**—Thin, diagonal lines used to indicate the surface of an imaginary cut in an object.
- SECTIONAL VIEW**—The view obtained by cutting away part of an object in an illustration to show the shape and construction of the interior.
- SEPIA**—A dark, warm brown color of low brilliance.
- SEPIA INTERMEDIATE**—An intermediate used in making duplicate transparencies by the whiteprint process.
- SERIF**—The finishing stroke or line projecting from the end of the main stroke of many letters in some typefaces.
- SET PALETTE**—One hue mixed with a group of colors to create color harmony or unity in a chosen palette.
-

Continued on next page

Glossary, Continued

- S (Continued)** **SETTING**—Background or surrounding.
- SHADE**—A mixture of pure color and black.
- SHADING**—Lines, values, or color applied to create form, shadow, or pattern.
- SHADING MEDIUMS**—Preprinted tones and patterns used to enhance the appearance of copy and artwork.
- SHADING SHEETS**—Sheets of cellophane or acetate preprinted with tones and patterns with a low-tack adhesive for applying to artwork.
- SHAPE**—The flat silhouette or two-dimensional form of an object.
- SHELF LIFE**—The length of time before sensitized material deteriorates.
- SHIP'S CURVES**—Instruments for drawing elongated, irregular curves that closely approximate the curves found in shipbuilding.
- SHUTTER SPEED**—A method of controlling the length of time that light can reach a film.
- SIGHT LINE**—An imaginary line extending from the eyes of a figure in a drawing to an object indicating that person's direction of glance.
- SINGLE-ACTION AIRBRUSH**—A device that releases both air and pigment by pressing down on a button.
- SIGNATURE**—A sheet of paper printed on both sides and folded to make up part of a publication.
- SILHOUETTE**—An outline of an object or figure filled in solidly without indication of modeling or surface structure.
- SILKSCREEN**—A method of printing through a stencil fixed to a screen of natural or synthetic fiber or metal mesh.
-

Continued on next page

Glossary, Continued

S (Continued)

SIZE—*Also called SIZING.* Various gelatinous materials made from starch, clay, glue, and casein used for glazing or coating papers and cloths.

SKETCH—A quickly executed drawing as a preparation toward more finished work.

SKETCHING PENCIL—See **CARPENTER'S PENCIL**. A soft—lead pencil used for freehand sketching.

SMALL CAPS—Capital letters smaller than the standard capitals of a typeface and the size of the body of the lowercase letters.

SODIUM THIOSULFATE—*Also called HYPO.* A salt with water solution that dissolves the silver halides used in photographic papers and films.

SOFT EDGE—A blended or graduated transition from one value or color to another.

SOFTWARE—Computer programs that direct the output devices and determine the input devices effectivity.

SPECIAL EFFECTS GENERATOR—A device that adds or creates effects to visual images during recording on videotape.

SPECIAL IRREGULAR CURVE—Irregular curves for a specific purpose, such as ship's curves, mechanical engineer's curves, conic sections, logarithmic spirals, and flexible curve rules.

SPECTRUM—The arrangement of colors side-by-side as refracted by a prism.

SPEEDBALL PENS—Lettering and drawing pens manufactured by the Hunt Manufacturing Company that are the hallmark of hand lettering pen nibs.

SPEED LINES—Extra lines following a moving figure or object in a cartoon representing the disturbance the movement causes in the atmosphere.

Continued on next page

Glossary, Continued

- S (Continued)** **SPHERE**—A form where all points are equidistant from the center.
- SPINE**—The bound edge of a book.
- SPLINE**—A flexible rule, held in place by lead ducks, used to draw irregular curves.
- SPLIT BRUSH TECHNIQUE**—*Also called DRY BRUSH TECHNIQUE.* Painting or drawing with a brush having the hairs separated to form more than one point.
- SPLIT COMPLEMENT**—A color scheme that uses a key hue with the two colors that lie adjacent to its opposite on the color wheel.
- SPLIT FIELD**—A rangefinder that focuses an image by dividing the image in half and requiring alignment into a whole.
- SPOT COLOR**—Using a combination of two individual colors, a main color, usually black, and an accent color instead of a full—color output.
- SQUEEGEE**—(1)An implement used on silk process printing presses that forces ink and ink compounds through the screen and stencil onto a printing surface to form the image; (2) The process of forcing pigment across a surface with other than a brush.
- STABILIZER**—A chemical that arrests the continued development of an image and fixes that image into the surface.
- STABILO PENCIL**—A pencil that uses grease or wax as a binder for pigment and is capable of writing on glass.
- STAT**—*See* PHOTOSTAT.
- STATIC**—Lacking in movement.
- STATION POINT**—The point of observation in the making of perspective drawings.
-

Continued on next page

Glossary, Continued

- S (Continued)**
- STILL LIFE**—A pictorial arrangement of inanimate objects.
- STIPPLE**—The effect obtained by using a series of dots or flicks in drawing.
- STOCK**—Material printed or worked on by printers or artists.
- STOP BATH**—A chemical solution that stops photographic development.
- STOPPER**—An eye-catching device in a picture that grabs and holds a viewer's attention.
- STORYBOARD**—A panel presentation of rough sketches of a proposed series of views.
- STRAIGHTEDGE**—An instrument with long, straight edges
- STRIP IN**—To position copy not pasted up on the mechanical before platemaking.
- STRIPPING**—Cutting out and placing in position.
- STUDIO CARD**—Illustration or pictorial information on a card intended for television transmission.
- STUMP**—A pencil-shaped roll of paper used to blend pastel, pencil, and charcoal.
- STYLIZED**—Characterized by an emphasis on style and design.
- STYLUS**—A scraping instrument with sharp or chiseled edge.
- SUBHEAD**—A secondary headline or title.
- SUBTRACTIVE COLOR PROCESS**—The process of forming colors by mixing pigments.
-

Continued on next page

Glossary, Continued

S (Continued) **SUBORDINATION**—Subduing part of a picture to make it less important than another part.

SUPERIMPOSED—*Also called* SUPER. One image or text placed over another without totally obscuring the first.

SUPERIMPOSED IMAGE—A rangefinder that focuses an image by requiring the alignment of two images over each other.

SUPPORT—The reinforcement or backing for a painted surface.

SURREALISM—An art movement whose objective is to explore the realm of unconscious emotion and dreams.

SWATCH—A small sample specimen.

SWEDE PEN—A broad nibbed, adjustable ruling pen.

SWIPE FILE—*See* RESEARCH FILE.

SYMBOL—A visual element that represents something else.

SYMMETRY—Similarity in size, shape, and relative position of parts on opposite sides of a dividing line.

T **TABOURET**—A portable cabinet used to hold the artist's drawing tools and materials.

TEAR SHEETS—*Also called* CLIP ART and PICTURE MORGUE.

TECHNICAL ILLUSTRATION—Drawings for technical reports, proposals, manuals, and catalogs, as well as visual aids, briefing charts, projecturals, slides, and posters.

TECHNIQUE—(1) The method of using a tool or medium; (2) The characteristic appearance of a medium; (3) The particular style of an artist.

Continued on next page

Glossary, Continued

- T (Continued)** **TELEPHOTO LENS**—A long focal-length lens that has the effect of bringing far objects nearer.
- TELEVISION GRAPHICS**—Graphics created specifically for transmission via television.
- TEMPURA**—Dry pigment mixed with an emulsion of egg yolk or milk to form an opaque watercolor.
- TEMPLATE**—A guide made to ensure the uniform consistency of frequently used symbols.
- TERTIARY COLORS**—Any intermediate hue that contains some part of each of the three primary colors.
- TEXT**—Typewritten or printed matter forming the main body of a work.
- TEXTURE**—The feel or appearance of a surface created by the repetition of forms or design.
- THERMAL TRANSFER PRINTER**—A printer that uses heat to fuse the image to a paper surface.
- THIRD DIMENSION**—The effect of depth or bulk achieved by the artist on a flat surface.
- THREE DIMENSIONAL**—Possessing height, width, and depth.
- THREE-QUARTER VIEW**—A view of an object rotated to a position halfway between a front and a side view.
- THREE-POINT PERSPECTIVE**—A view where no dimension, height, width, or depth, is parallel to the plane of projection.
- THUMBNAIL SKETCH**—Page layouts showing the allocation of space for headings, photographs, line artwork, and text.
-

Continued on next page

Glossary, Continued

- T (Continued)**
- THUMBSPOTS**—Visual indicators placed on a slide mount to identify the emulsion side of the film and simplify tray loading.
- TILING**—A fill pattern effect that repeats a pattern over and over.
- TILT CARD**—A vertical card that requires up-and-down camera movement.
- TIME LINE**—A projected plan of execution outlining significant milestones and deadlines used to monitor work in progress closely.
- TINT**—A mixture of pure color and white.
- TISSUE OVERLAY**—Thin, translucent paper placed over artwork for protection and corrections.
- TITANIUM WHITE**—An opaque white.
- TITLE BLOCK**—Space in the lower right corner that contains the identity of the drawing, the subject matter, the origins, the scale, and other data.
- TITLE CARD**—A television card that contains text only.
- TONAL**—Having gradations of gray or intermediate values.
- TONE**—(1) A value usually predominate which sets the key; (2) A thin layer of paint applied to a ground to eliminate the whiteness of the surface before painting.
- TOOL BOX**—*See* BUTTON BAR.
- TOOTH**—The ability of the paper surface to accept various mediums.
- TORTILLON**—*Also called* STUMP or STOMP. Tightly rolled paper, leather, or felt used to blend charcoal, pastels, pencil, chalk, or crayon.
- TOUCHE**—A liquid-masking agent or lithographic crayon applied by brush to a lithographic plate or stone.

Continued on next page

Glossary, Continued

T (Continued)

TOUCH SCREEN TECHNIQUE—Activating the pixels on a CRT screen through the touch of an electronic light pen or the fingertip.

TRACING PAPER—A thin, transparent, or translucent paper used for transferring an image from one surface to another by tracing.

TRACKBALL—*See* JOYSTICK or MOUSE.

TRAMMEL—A mechanical device used to draw an ellipse.

TRANSFER SHEET—Preprinted characters and symbols on cellophane or acetate used in preparing cold composition, camera-ready copy.

TRANSLUCENT—The characteristic of allowing light to pass through without permitting objects to be seen clearly through it.

TRANSPARENCY—Any transparent material intended for projection that bears an image.

TRANSPARENT—The characteristic of allowing light and objects to be seen clearly through it.

TRAPS—A slight overlap of the outline of an element to prevent white space from showing around the edges minimizing the effect of press plate misalignment.

TRIAD—The use of any three pigments equally spaced on a color wheel.

TRIANGLE—A triangular shaped ruling guide available in various sizes and angles usually made of clear plastic or metal.

TRIM MARKS—Marks used on printed sheets or other substrate to indicate where to cut or trim stock both vertically and horizontally.

TRIMETRIC PROJECTION—An axonometric projection of an object where no two axes make equal angles with the plane of projection requiring three different foreshortening ratios.

Continued on next page

Glossary, Continued

- T (Continued)** **T-SQUARE**—A ruling guide with a 90° angled crosspiece at one end used in making horizontal lines.
- TURPENTINE**—A solvent distilled from the sap of pine or from pine wood used as a thinner and to clean brushes.
- TUTORIAL**—A lesson guide.
- TWO DIMENSIONAL**—Flat, without depth, having only width and height.
- TWO-POINT PERSPECTIVE**—*Also called* ANGULAR PERSPECTIVE. The most common type of perspective drawing where the object is sitting at an angle to the plane of projection and each object has two vanishing points.
- TYPEFACE**—The printing surface of an alphabet judged by its design, printability, wearability, and position on the letter body.
- TYPE FAMILY**—A group of typefaces similar although not exactly alike in design.
- TYPE SERIES**—Different sizes of the same typeface.
- TYPESETTERS, PHOTOGRAPHIC**—Machines that supply a variety of type designs and sizes, automatically letterspaced and justified on transparent film or plastic-coated opaque paper.
- TYPOGRAPHY**—The art of type selection and arrangement.
-

- U** **ULTRAVIOLET LIGHT**—Actinic (shorter wavelength) or useable part of the light spectrum needed to react or harden light—sensitive coatings.
- UNDERTONE**—A color whose effect is modified by other colors imposed over them.
- UNRETOUCHED**—Not altered or improved by any means.
-

Continued on next page

Glossary, Continued

U (Continued) **UPPERCASE**—The capital letters of an alphabet.

USER INTERFACE—The visual and physical attributes of a software program including tools-, text-, and graphics-handling characteristics.

UTILITY PLAN—A floor plan of a structure showing locations of heating, electrical, plumbing, and other service components.

V **VALUE**—The relative lightness and darkness of different areas of the picture represented in tones, shading, line balance, and layout.

VALUE SCALE—The complete range of values from the lightest to the darkest.

VAN DYKE—A brownprint negative and sometimes a brownline positive.

VANISHING POINT—The point at which parallel lines receding from the observer appear to converge in a perspective drawing or photograph.

VARIGRAPH—A lettering device that allows manipulation of letter size, slant, and shape.

VARNISH—A solution made of a resin in a volatile medium.

VEHICLE—A liquid used as a carrier of pigment in paint.

VECTOR-BASED—Images based on a series of plotted points that define precise lines and geometric shapes.

VELLUM—A kind of fine, translucent paper resembling parchment or onion skin used for duplicating copies made with a whiteprint machine.

VELOX—A print of a photograph or other continuous-tone copy prescreened before paste-up or platemaking with line copy eliminating the need for a composite negative.

Continued on next page

Glossary, Continued

- V (Continued)** **VERTICAL SCAN RATE**—*Also called* FRAME RATE. The number of times per second a screen redraws an image.
- VIDEO DIGITIZING CAMERA**—A camera or film recorder attached to the front of a CRT screen used to record images.
- VIDEO DISPLAY TERMINAL (VDT)**—A visual display used in photocomposition work in conjunction with a keyboard.
- VIEWING PLANE LINE**—*See* CUTTING PLANE LINE.
- VIEWGRAPH**—*See* PROJECTURAL.
- VIEWPOINT**—The eye level of the viewer and the distance from the scene.
- VIGNETTE**—Fading an image from heavier to lighter tones blending it into the background or eliminating the background altogether.
- VISIBLE LINE**—The outline used for all edges seen by the eye.
- VISUALIZING PAPER**—A white, semitransparent paper used for making layouts and preliminary drawings.
- VISUAL LITERACY**—The ability to communicate effectively using only visual language.
-

- W** **WARM COLORS**—Colors associated with heat or fire.
- WASH**—A monochromatic rendering with a brush and transparent watercolor.
- WASH DRAWING**—A watercolor painting consisting mainly of washes.
- WATERCOLOR**—A dry pigment bound by an adhesive, such as gum arabic, and applied, greatly reduced by water, to a surface in a transparent fashion.
-

Continued on next page

Glossary, Continued

W (Continued) **WAXER**—A device that applies a thin layer of hot, adhesive wax to the back of a surface.

WET BRUSH—A blending technique of laying two pigments side-by-side and blurring the line of demarcation while the pigments are still wet.

WHITE LEAD—A fine, poisonous, opaque white pigment used in flake white and Cremnitz white oil paints.

WIDE ANGLE LENS—A very short focal-length lens that encompasses a larger horizontal view than a standard lens. This lens, depending on the focal length, records an image with increasingly pronounced (barrel) distortion.

WINDOW—*See* BLACK PATCH.

WORD PROCESSING—The transformation of a concept or idea into printed communication media by using mechanical or automated systems, methods, or processes.

WORD SPACING—The adjustment of spacing between words to shorten or extend a line to achieve justification.

WORKING DRAWING—A thorough preliminary drawing done on tracing paper then transferred to a working surface for the finished rendering.

WOVE PAPER—A broad range of papers having an even fiber formation produced over fine wire mesh.

WRAPPING—(1) A computer feature that automatically enters a soft return reveal code and continues to enter data from the same sentence on another line; (2) Selecting a pattern or design and wrapping it around an object on the screen.

WRICO—A hand-lettering system using a set of templates and a drop fed pen.

Continued on next page

Glossary, Continued

X **XEROGRAPHY**—A copying process that uses electrostatic forces to form an image.

Z **ZINC WHITE**—A zinc-oxide based pigment that is less opaque than titanium and lead white.

ZIP-A-TONE—A transparent acetate sheet preprinted with patterns of dots or lines that create tone.

ZONE NUMBERS—Numbers and letters on the border of a drawing to provide reference points to aid in locating specific points in the drawing.

ZOOM LENS—A variable focal-length lens that functions as a telephoto lens but allows you to select the range of the object magnification.

APPENDIX II

References Used To Develop The TRAMAN

NOTE: Although the following references were current when this TRAMAN was published, you will need to ensure you are studying the latest revision.

-
- Chapter 1** Mayer, Ralph, ed., Preiss, David, *Ralph Mayer Answers 101 Questions Most Frequently Asked by Artists*, M. Grumbacher, Inc., New York, NY, 1977.
- Quiller, Stephen and Barbara Wipple, *Water Media Techniques*, Watson-Guptill Publications, New York, NY, 1983.
- Taubes, Frederic, *The Painter's Dictionary of Materials and Methods*, Watson-Guptill Publications, New York, NY, 1979.
-
- Chapter 2** Destree, Thomas M., ed., *The Lithographers Manual*, 9th Ed., The Graphic Arts Technical Foundation, Inc., Pittsburgh, PA, 1996.
- Eckstein, Helene W., *Color in the 21st Century*, Watson-Guptill Publications, New York, NY, 1991.
- Photography (Basic)*, NAVEDTRA 12700, Naval Education and Training Professional Development and Technology Center, Pensacola, FL, 1993.
- Pocket Pal, A Graphic Arts Production Handbook*, International Paper Company, Memphis, TN, 1995.
-
- Chapter 3** Bro, Lu, *Drawing, A Studio Guide*, W. W. Norton & Company, New York, NY, 1978.
- Edwards, Betty, *Drawing On the Right Side of the Brain*, Jeremy P. Tarcher, Inc., Los Angeles, CA, 1989.
-
- Chapter 4** de Silva, Raul, *The World of Animation*, Kodak Company, Rochester, N.Y, 1979.
-

Continued on next page

References Used To Develop The TRAMAN, Continued

Chapter 5

George, Ross F., *The Speedball Textbook for Pen and Brush Lettering*, 19th Ed., Hunt Manufacturing Co., Philadelphia, PA, 1965.

Reynolds, Lloyd J., *ITALIC Calligraphy & Handwriting Exercises and Text*, Pentatic Corporation, New York, NY, 1969.

Shepherd, Margaret, *Capitals for Calligraphy*, Collier Books, New York, NY, 1982.

Shepherd, Margaret, *Using Calligraphy*, Collier Books, New York, NY, 1982.

Chapter 6

Maurello, S. Ralph, *The Complete Airbrush Book*, William Penn Publishing Corp., New York, NY, 1955.

Mette, C. Michael, *Airbrush Techniques: Metallic Effects*, North Light Graphic Workbooks, Cincinnati, OH, 1984.

Siegel, Peter, *The Complete Airbrush Book*, Leon Amiel Publisher, New York, NY, 1986.

Chapter 7

Simon, Michael and Dennis Moore, *First Lessons in Black-and-White Photography*, Holt, Rinehart, and Winston, New York, NY, 1978.

Photography (Basic), NAVEDTRA 12700, Naval Education and Training Professional Development and Technology Center, Pensacola, FL, 1993.

Chapter 8

Biow, Lisa, *How To Use Your Computer*, Ziff-Davis Press, Emeryville, CA, 1993.

Step-By-Step Electronic Design, Step-By-Step Publishing Company, Dynamic Graphics Inc., Peoria, IL.

INDEX

A

- Acrylic-Based Pigments, 1-53
 - acrylic finishing, 1-55
 - acrylic paint, 1-53
 - acrylic paint extenders, 1-53
 - acrylic paint grounds, 1-54
 - acrylic paint impasto, 1-53
 - acrylic paint permanence and opacity, 1-54
 - acrylic paint storage, 1-55
 - exercises in acrylic paint, 1-55
 - painting in acrylic paint, 1-54
 - special equipment, 1-55
 - substrates, 1-54
- Additive Theory of Light, 2-9
- Airbrushes, 6-3
 - double-action airbrushes, 6-6, 6-7
 - gravity-fed airbrushes, 6-10
 - holding an airbrush, 6-9
 - left-handed airbrushes, 6-9
 - oscillating airbrushes, 6-9
 - pressure-fed airbrushes, 6-9
 - single-action airbrushes, 6-4
 - siphon-fed airbrushes, 6-10
 - using a double-action airbrush, 6-7, 6-8
- Airbrush Pigments, 6-20
 - mixing pigments, 6-20
 - pigments, 6-20
 - pigment stain, 6-20
 - pigment viscosity, 6-20
 - solvents for pigments, 6-20
- Animation, 4-9
 - animation techniques, 4-9
 - coloring the cel, 4-14
 - computer-generated animation, 4-14
 - creating the cel, 4-14
 - flipping, 4-14
 - model sheets, 4-10, 4-11

Continued on next page

INDEX, Continued

- A (Continued)**
- Animation (Continued), 4-9,
 - photographing the cel, 4-14
 - pre-animation requirements, 4-9
 - range of action, 4-13
 - spacing guides, 4-12
 - Aperture, 7-25
 - aperture settings, 7-26
 - aperture settings without light meters, 7-27
 - iris diaphragm, 7-25
-

- B**
- Basic Drawing, 3-3
 - advanced drawing, 3-3
 - exercises, 3-3
 - practice, 3-3
 - traditional drawing skills, 3-3
 - Basic Equipment, 4-15, 4-16
 - additional equipment, 4-16
 - practice, 4-16
 - Basic Rendering Techniques, 3-19
 - arrangement, 3-20
 - light, 3-21
 - light source, 3-23
 - reflections, 3-23
 - tone, 3-21
 - using light, tone, and value, 3-22
 - value, 3-22
 - viewpoint, 3-19
 - Basic Shapes, 3-11
 - cones, 3-15
 - cubes, 3-12
 - cylinders, 3-14
 - spheres, 3-13
 - Basic Shapes (airbrushed)
 - cones, 6-46
 - cubes, 6-40, 6-41
 - cylinders, 6-44, 6-45
 - spheres, 6-42, 6-43
-

Continued on next page

INDEX, Continued

- B (Continued)**
- Brushes, 1-25
 - bright brushes, 1-28
 - bristle 'length, 1-27
 - brush bristle nomenclature and testing, 1-26
 - brush bristles, 1-27
 - brush shape, 1-27
 - brush size, 1-28
 - cleaning brushes, 1-29
 - fan-shaped brushes, 1-28
 - ferrule, 1-28
 - flat brushes, 1-28
 - handles, 1-29
 - paint brushes, 1-25
 - round-shaped brushes, 1-28
 - shaping brushes, 1-30
 - storage, 1-30
 - storing oil brushes, 1-30
-

- C**
- Calligraphy, 5-54
 - basic strokes, 5-59
 - calligraphic terms, 5-54
 - distance between guidelines, 5-58
 - forming words in sequence - returning to the m-chain, 5-62
 - guidelines, 5-57
 - holding the pen, 5-56
 - in-the-round lettering, 5-63
 - left-handed calligraphy, 5-55
 - m-chain method, 5-60
 - practice, 5-56
 - progressing from the m-chain, 5-61
 - variations, 5-64
 - Cameras, 7-4
 - camera adjustments, 7-6, 7-7
 - camera maintenance, 7-4
 - camera planes, 7-5
 - camera theory, 7-4
 - Caricature, 4-8
-

Continued on next page

INDEX, Continued

- C (Continued)**
- Cartoons, 4-3
 - advantages of cartoons, 4-3
 - balloons, 4-7
 - exaggerated cartoons, 4-5
 - semi-realistic cartoons, 4-4
 - cartoon strips, 4-6
 - Color Electronic Prepress Systems, 2-35
 - CEPS scanners, 2-35
 - Combining Forms, 3-16
 - details, 3-18
 - drawing forms, 3-17
 - enlarging the sketch, 3-16
 - shading, 3-18
 - thumbnails, 3-16
 - Common Software Commands, 8-26
 - commands, 8-26
 - EDIT features, 8-27
 - FILE features, 8-26
 - TOOLS features, 8-29
 - VIEW features, 8-28
 - Common Software Features, 8-14
 - close or exit, 8-17
 - cursors and pointers, 8-14, 8-15
 - HELP, 8-22
 - icons, 8-15
 - menus, 8-17, 8-18, 8-19, 8-20, 8-21
 - minimize and maximize, 8-17
 - program and file names, 8-16
 - screen displays, 8-15
 - scroll bars, 8-23
 - windows, 8-16
 - Common Software Options, 8-24
 - bold, italics, and underline, 8-25
 - font related options, 8-25
 - justification, 8-25
 - line spacing, 8-25
 - symbology, 8-25
 - tables and columns, 8-25
-

Continued on next page

INDEX, Continued

- C (Continued)
 - Common Software Options (Continued), 8-24
 - zoom, 8-25
 - toolbars, 8-24
 - Component Parts, 6-11
 - air hoses, 6-12
 - air sources, 6-11
 - moisture traps, 6-14
 - regulators, 6-13
 - Contour Drawing, 3-4
 - blind contour, 3-5
 - cross contour, 3-7
 - felt contour, 3-6
 - negative contour, 3-8
 - inversion contour, 3-9
-

- D
 - Desktop Color, 2-36
 - color monitors, 2-37
 - image capture, 2-37
 - memory, 2-36
 - scanners, 2-36
 - video graphics array (VGA), 2-36
 - Desktop Publishing Software, 8-51
 - desktop publishing software manuals, 8-52
 - frames, 8-52
 - style sheets, 8-52
 - tags, 8-52
 - Directories and Subdirectories, 8-30
 - archiving, 8-33
 - directories or files, 8-30
 - file listings, 8-32, 8-33
 - naming a file or folder, 8-32
 - purging files, 8-33
 - subdirectories or folders, 8-31
-

Continued on next page

INDEX, Continued

- E**
- Elemental Construction, 4-17
 - animal forms, 4-37, 4-38, 4-39, 4-40
 - construction the cartoon figure, 4-30, 4-31, 4-32
 - creating character with cartoon heads, 4-25, 4-26
 - drawing the cartoon head, 4-18, 4-19, 4-20
 - drawing through, 4-34
 - features of cartoon heads, 4-27, 4-28, 4-29
 - feet, 4-36
 - foreshortening, 4-33
 - foundation, 4-17
 - hands, 4-35
 - positioning cartoon heads, 4-21, 4-22, 4-23, 4-24
 - Electronic Cameras, 7-14
 - electronic imagery capture, 7-14
 - electronic imagery display, 7-14
 - electronic imagery enhancement, 7-14
 - electronic photographic capture, 7-14
 - Erasers
 - air erasers, 1-11
 - electric erasers, 1-10
 - hand-held erasers, 1-8, 1-9
 - types of erasers, 1-8
 - Even Tones, 6-26, 6-27
 - Expression, 3-54
 - directional lines, 3-55
 - posturing, 3-54
-

- F**
- Facial Features, 3-42
 - ears, 3-48
 - eyes, 3-45
 - features in profile, 3-43
 - feature proportions, 3-44
 - location of the facial features, 3-42
 - mouth and chin, 3-47
 - nose, 3-46
-

Continued on next page

INDEX, Continued

- F (Continued)**
- Figure Drawing, 3-24
 - approaching figure drawing, 3-24
 - combining the techniques of gesture drawing and reducing the figure into basic forms, 3-26
 - common errors, 3-30
 - composite drawings of the figure, 3-27, 3-28, 3-29
 - figure profiles, 3-33
 - figure proportions, 3-30
 - foreshortening, 3-35
 - gesture drawing the human form, 3-24
 - measuring adult figure height with the head, 3-30, 3-31
 - measuring adult figure width with the head, 3-32
 - measuring the child figure with the head, 3-34
 - reducing the figure to basic forms, 3-25
 - Figure Elements, 3-36
 - torso, 3-36
 - arms, 3-37
 - hands and feet, 3-39, 3-40
 - head, 3-41
 - legs, 3-38
 - File Formats, 8-34
 - American Standard Code for Information Interchange (ASCII), 8-35
 - encapsulated Postscript file format (EPS or EPSF), 8-35
 - file compression, 8-36
 - file format suffixes, 8-36
 - graphics images file format, (GIF or GIFF), 8-36
 - raster image file format, (RIF or RIFF), 8-35
 - saving file formats, 8-35
 - tagged image file format, (TIF or TIFF), 8-35
 - Films, 7-34
 - black-and-white film composition, 7-34
 - color film, 7-35
 - color film balance, 7-40
 - emulsion sensitivity, 7-36
 - film characteristics, 7-36
 - film contrast, 7-39
 - film date expiration, 7-40
 - film emulsion definition, 7-39, 7-40

Continued on next page

INDEX, Continued

- F (Continued)**
- Films (Continued), 7-34
 - film emulsion latitude, 7-39
 - film exposure latitude, 7-39
 - film format, 7-35
 - film handling, 7-40
 - film speed, 7-37
 - film storage, 7-40
 - roll film, 7-35
 - sheet or cut film, 7-36
 - spectral sensitivity, 7-37, 7-38
 - video disks, 7-36
 - Finished Prints, 7-44
 - cropping, 7-44
 - cropping in the darkroom, 7-44
 - cropping outside of the darkroom, 7-44
 - indicating crop marks, 7-44
 - marking enlargements or reductions on a print, 7-45
 - scaling artwork, 7-45
 - scaling images in the darkroom, 7-45
 - scaling images outside the darkroom, 7-45
-

- G**
- Gesture Drawing, 3-10
 - Graduated Tones, 6-28, 6-29
 - Graphics Software, 8-38
 - auto-trace tools, 8-40
 - blending tools, 8-43
 - color capabilities, 8-49
 - color formats, 8-49
 - color special effects, 8-49, 8-50
 - common graphics software features, 8-39
 - graphics software programs, 8-38
 - graphics software programs manuals, 8-38
 - graphics software programs memory, 8-38
 - image-creation programs, 8-38
 - image-editing programs, 8-39
 - image-presentation programs, 8-39
 - isolating tools, 8-40
-

Continued on next page

INDEX, Continued

- G (Continued)** Graphics Software (Continued), 8-38
 layering, 8-39
 movement or select tools, 8-40
 rendering tools, 8-41, 8-42
 shape tools, 8-40
 stylizing filters, 8-44, 8-45, 8-46, 8-47, 8-48
 working in color, 8-50
-

- I** Incidental Construction, 4-41
 clothing, 4-41
 props, 4-44
 settings, 4-42, 4-43
-

- L** Lenses, 7-28
 depth of field, 7-32, 7-33
 focal length, 7-28, 7-29
 lens aperture, 7-32
 lens characteristics, 7-28
 lens coverage, 7-3 1
 lens interchangeability, 7-28
 lens' range, 7-30
 long-range lenses, 7-30
 macro lenses, 7-30
 short-range lenses, 7-30
 standard-range lenses, 7-30
 variable lenses, 7-31
Lettering, 5-3
 calligraphy, 5-5
 lettering, 5-3
 lettering on technical drawings, 5-4
 lettering versus printing, 5-3
Letter Classifications, 5-18
 capital letters, 5-18
 contemporary letter group, 5-26
 gothic letter group, 5-22
 italic letter group, 5-26
 lower case letters, 5-19
-

Continued on next page

INDEX, Continued

- L (Continued)**
- Letter Classifications (Continued), 5-18
 - major groupings, 5-20
 - roman letter group, 5-21
 - script letter group, 5-23, 5-24
 - text letter group, 5-25
 - Letter Compositions, 5-32
 - centering, 5-40
 - compositions, 5-32
 - flush left or right, 5-41
 - formal lettering composition, 5-33
 - informal lettering composition, 5-34
 - justification, 5-41
 - legibility, 5-35, 5-36, 5-37, 5-38, 5-39
 - negative letters, 5-42
 - overlapping letters, 5-42
 - Letter Geometry, 5-13
 - guidelines, 5-13, 5-14, 5-15
 - letter weight, 5-16, 5-17
 - Letter Nomenclature, 5-6
 - component parts, 5-11, 5-12
 - font metrics, 5-10
 - typefaces or type styles, 5-6
 - typeface x-rating, 5-9
 - type families, 5-7
 - type fonts, 5-6
 - type series, 5-7
 - type size - height, 5-8
 - type size (height) on electronic or mechanical devices, 5-8
 - Letter Strokes, 5-27
 - basic strokes of gothic letters, 5-29
 - basic strokes of roman-style letters, 5-30
 - basic strokes of script, 5-31
 - practice lettering strokes, 5-28
 - strokes, 5-27
-

Continued on next page

INDEX, Continued

- L (Continued)**
- Lettering Aids, 5-50
 - computer-generated letters, 5-52
 - letterguides, 5-50
 - lettering templates, 5-50, 5-51
 - photolettering devices, 5-52
 - pressure process lettering devices, 5-53
 - transfer letters, 5-53
 - Lettering Mediums, 5-43
 - brush letters, 5-46, 5-47, 5-48
 - chalk, charcoal, pastel, and felt-tipped letters, 5-49
 - lettering surfaces, 5-43
 - media, 5-43
 - pencil letters, 5-44
 - pens and ink letters, 5-45
 - Light, 2-4
 - absorption, 2-7
 - characteristics of light, 2-5
 - polarization, 2-8
 - reflection, 2-6
 - transmission, 2-7
 - wave motion theory, 2-5, 2-6
-

- M**
- Maintenance, 6-15
 - cleaning airbrushes, 6-15, 6-16, 6-17, 6-18, 6-19
 - cleanliness, 6-15
 - compressor maintenance, 6-19
 - Metallic Effects, 6-32, 6-33, 6-34
-

- O**
- Oil-Based Pigments, 1-48
 - alla prima, 1-52
 - enamel-based pigments, 1-50
 - exercises in oil paint, 1-52
 - finishing techniques, 1-52
 - improvised painting, 1-52
 - lacquer-based pigments, 1-50
 - lacquer- and enamel-based pigments, 1-50
 - oil paint, 1-48
-

Continued on next page

INDEX, Continued

- O (Continued)** Oil-Based Pigments (Continued), 1-48
- oil paint extenders, 1-4
 - oil paint grounds, 1-49
 - oil paint impasto, 1-48
 - oil paint opacity and permanence, 1-49
 - oil paint reducers, 1-48
 - oil paint storage, 1-52
 - overpainting, 1-51
 - painting with oil paints, 1-51
 - special equipment, 1-52
 - substrates, 1-49, 1-50
 - underpainting, 1-51
-

- P**
- Paper, 1-4
 - humidity, 1-5
 - paper products, 1-4
 - paper quality, 1-4
 - paper size, 1-5
 - paper surfaces, 1-5
 - paper types, 1-6, 1-7
 - paper weight, 1-4
 - Papers (photographic), 7-41
 - black-and-white paper emulsion, 7-41
 - color paper emulsion, 7-41
 - paper characteristics, 7-41
 - paper contrast, 7-42
 - paper emulsion sensitivity, 7-41
 - paper expiration, 7-43
 - paper format, 7-41
 - paper handling, 7-43
 - paper storage, 7-43
 - paper surface, 7-42
 - paper spectral (color) sensitivity, 7-42
 - Pastels and charcoals, 1-44
 - charcoal, 1-44
 - charcoal finishing, 1-44
 - conté crayon, 1-45
-

Continued on next page

INDEX, Continued

- P (Continued)**
- Pastels and Charcoals (Continued), 1-44
 - conté crayon finishing, 1-45
 - degrees of hardness, 1-44, 1-45
 - degree of softness, 1-46
 - drawing with charcoal, 1-44
 - drawing with conté crayon, 1-45
 - drawing with pastels, 1-46
 - exercises in charcoal and pastel, 1-47
 - oil chalk, 1-46
 - pastels, 1-46
 - pastel finishing, 1-46
 - storing pastels, 1-46
 - Pencils, 1-12
 - carbon pencils, 1-24
 - color pencils, 1-24
 - draftsman's pencil sharpener, 1-17
 - hard leads, 1-13
 - holding the pencil, 1-14
 - humidity, 1-13
 - line weight, 1-21
 - medium leads, 1-13
 - position of the body and the arm, 1-15
 - regular office pencil sharpener, 1-17
 - sandpaper pads, 1-18, 1-19, 1-20
 - selection, 1-12
 - sharpening a pencil, 1-16
 - soft leads, 1-13
 - texture, 1-21
 - pencil illustration, 1-23
 - tone, 1-22
 - variation, 1-13
 - warm-up exercises, 1-15
 - Pens and Inks, 1-31
 - assemble tools, 1-39
 - basic pencil drawing, 1-39
 - brushes, 1-39
 - drawing nibs, 1-31
 - drawing over pencil lines in ink, 1-38
-

Continued on next page

INDEX, Continued

- P (Continued)**
- Pens and Inks (Continued), 1-31
 - graded washes, 1-42
 - improper pen handling, 1-35
 - indefinite blends, 1-43
 - ink, 1-37
 - ink drawing, 1-37
 - ink washes, 1-38
 - lettering nibs, 1-32
 - pen care, 1-36
 - pen nibs, 1-31
 - preparing for ink washes, 1-38
 - preparing the pigment, 1-39
 - preparing a paper surface, 1-38
 - reservoir pens, 1-33, 1-34
 - special effects materials, 1-39
 - stretching the paper, 1-38
 - textural variations, 1-37
 - working in wash, 1-40, 1-41
 - Photographic Retouching, 6-57
 - Pictorial Rendering, 6-47, 6-48, 6-49, 6-50
 - Preparing to Airbrush, 6-21
 - friskets, 6-23, 6-24
 - masks, 6-22
 - painting surfaces, 6-21
 - steps in airbrushing, 6-25
 - thumbnails, 6-21
 - Process and Copy Cameras, 7-8
 - automatic sheet film and paper processing, 7-12
 - copy cameras, 7-13
 - copy camera adjustments, 7-13
 - copy camera exposure, 7-13
 - copy cameras film backs, 7-13
 - copy cameras lenses, 7-13
 - four-tray development, 7-11
 - printing, 7-12
 - process cameras, 7-8
 - process camera major components and adjustments, 7-9
 - sheet film and print development, 7-11

Continued on next page

INDEX, Continued

- P (Continued)** Process and Copy Cameras (Continued), 7-8
 using a process camera, 7-10
Process Color, 2-32
 color reproduction, 2-32
 fake color, 2-34
 flat color, 2-34
 how process color works, 2-32, 2-33
 process color, 2-32
 spot color, 2-34
-

- R** Rendering Techniques for Figure Drawing, 3-49
 action folds, 3-53
 clothing, 3-50
 gravity folds, 3-50, 3-51, 3-52
 light and shadow, 3-49
 tension folds, 3-53
-

- S** Settings, 3-56
 background, 3-57
 borders, 3-56
 crowds, 3-59
 perspective, 3-58
Small-Format Cameras, 7-15
 camera adjustments, 7-17
 film release, 7-20
 focal-plane shutters, 7-19
 frame indicator, 7-19
 ISO selection dial, 7-17
 leaf shutters, 7-18
 light meters, 7-20
 single lens reflex cameras, 7-16
 shutters, 7-18
 rangefinder cameras, 7-15
 using a 35mm camera, 7-21
-

Continued on next page

INDEX, Continued

- S (Continued)**
- Software, 8-5
 - applications software, 8-5
 - disk security markings, 8-11
 - electronic media, 8-10
 - installing applications software, 8-6
 - installing operating systems software, 8-5
 - Level I, 8-9
 - Level II, 8-10
 - Level III, 8-10
 - media disposition, 8-11
 - operating system software, 8-5
 - security, 8-8
 - security controls, 8-10
 - software or disk security, 8-8
 - using software wisely, 8-6, 8-7, 8-8
 - Shutter Speed, 7-22
 - recommended shutter speeds, 7-24
 - shutter speed dial, 7-23
 - shutter speed settings, 7-22
 - troubleshooting causes of blur, 7-23
 - Special Effects, 6-35
 - changing the angle between airbrush and paper surface, 6-39
 - increasing or decreasing distance between the airbrush and the paper surface, 6-38
 - raising, lowering, or moving masks, 6-36, 6-37
 - varying air pressure, 6-35
 - Spot Effects, 6-30, 6-31
 - Subtractive Theory of Color, 2-10
 - achromatic color schemes, 2-17
 - adjacency, 2-25
 - analogous color schemes, 2-19
 - color characteristics, 2-22
 - color effects, 2-26
 - color influence, 2-23
 - color mixing, 2-31
 - color schemes, 2-17
 - color wheel, 2-13, 2-14
 - complimentary color, 2-15
-

Continued on next page

INDEX, Continued

- S (Continued)** Subtractive Theory of Color (Continued), 2-10
 complimentary color schemes, 2-20
 dimensions of color, 2-15
 distance, 2-27
 harmonious color, 2-15
 hue, 2-15
 illumination, 2-24
 intensity, 2-17
 iridescence, 2-29
 local color, 2-23
 luminosity, 2-30
 luster, 2-28
 monochromatic color schemes, 2-18
 primary colors, 2-10
 proximity on the color wheel, 2-15
 secondary colors, 2-11
 set palette, 2-22
 split compliment color schemes, 2-21
 tertiary colors, 2-12
 triad color schemes, 2-21
 value, 2-16
-

- T** Technical illustrations, 6-51, 6-52, 6-53, 6-54, 6-55, 6-56
 Technique, 4-45
 practice, 4-45
-

- V** Viruses, 8-12
 virus identification, 8-12
 virus elimination, 8-12
 virus protection, 8-13
 virus transmission, 8-12
-

Continued on next page

INDEX, Continued

W

- Water-Based Pigments, 1-56
 - blending techniques, 1-61
 - casein, 1-59
 - casein characteristics, 1-59
 - casein finishing, 1-60
 - casein permanence, 1-59
 - casein storage, 1-59
 - dry brush blending, 1-63, 1-64
 - exercises in water-based media, 1-64
 - gouache, 1-57
 - gouache characteristics, 1-59
 - gouache finishing, 1-59
 - gouache permanence, 1-58
 - gouache storage, 1-59
 - special equipment, 1-60, 1-61
 - Water-Based Pigment (Continued), 1-56
 - watercolors, 1-56
 - watercolor characteristics, 1-57
 - watercolor finishing techniques, 1-57
 - watercolor permanence, 1-56
 - watercolor storage, 1-57
 - wet brush blending, 1-61, 1-62
 - Web Pages, 8-53
 - designing web pages, 8-54
 - frequently asked questions (FAQs), 8-54
 - reviewing web pages, 8-55
 - web addresses, 8-55
 - web page design, 8-53
 - web links, 8-53
 - web page language, 8-54
 - web page parameters, 8-54
 - Word Processing Software, 8-37
 - document formatting features, 8-37
 - word processing programs, 8-37
 - word processing software features, 8-37
 - word processing software manuals, 8-37
-

Assignment Questions

Information: The text pages that you are to study are provided at the beginning of the assignment questions.

ASSIGNMENT 1

Textbook Assignment: "Mediums," chapter 1, pages 1-1 through 1-54.

1-1. Which of the following paper types offer the most protection against premature chemical deterioration?

1. Rag
2. Wood pulp
3. Rag and wood pulp
4. Neutral-ph or archival

1-2. A ream of 150 lb oriental rice paper weighs a total of how many pounds?

1. 500
2. 350
3. 250
4. 150

1-3. What paper characteristic most controls the quality of your work?

1. Weight
2. Surface texture
3. Moisture content
4. Chemical composition

1-4. What paper surface is inappropriate for most calligraphy?

1. Hot pressed
2. Cold pressed
3. Plate finish
4. High surface

1-5. What paper surface absorbs the most moisture from the air?

1. Hot pressed
2. Cold pressed
3. Plate finish
4. High surface

1-6. What anomaly may result from drawing with a 4H pencil, on a humid day, using moderate to heavy pressure?

1. Brittleness
2. Wrinkling
3. Creasing
4. Scoring

IN ANSWERING QUESTIONS 1-7 THROUGH 1-10, SELECT FROM COLUMN B THE TYPE OF PAPER APPROPRIATE FOR THE PURPOSE LISTED IN COLUMN A. RESPONSES IN COLUMN B MAY BE USED MORE THAN ONCE.

A. PURPOSES

B. PAPERS

1-7. Transparency or translucence

1. Stencil board

1-8. Image transfer

2. Vellum

3. Saral paper

1-9. White lines on black backgrounds

4. Scratchboard

1-10. Protection of nonimage surfaces

1-11. What paper should be used for sketches or warm-up exercises?

1. Newsprint
2. Canvas board
3. Pastel paper
4. Illustration board

1-12. What substrate is suitable for all media?

1. Mat board
2. Canvas board
3. Illustration board
4. Scratchboard

1-13. Which of the following actions enhances the ability of a synthetic eraser to remove unwanted marks from a drawing?

1. Warming
2. Rotating
3. Kneading
4. Moistening

1-14. A soft grade eraser is which of the following colors?

1. White
2. Light pink
3. Amber
4. Red

IN ANSWERING QUESTIONS 1-15 THROUGH 1-17, SELECT FROM COLUMN B THE PURPOSE FOR THE TYPE OF ERASER LISTED IN COLUMN A. RESPONSES IN COLUMN B MAY BE USED MORE THAN ONCE.

| <u>A. ERASERS</u> | <u>B. PURPOSE</u> |
|-------------------|----------------------------|
| 1-15. Kneaded | 1. Vellum or Mylar |
| 1-16. Hard | 2. Blending and highlights |
| 1-17. Synthetic | 3. Removal of dark marks |
| | 4. Removal of light marks |

- 1-18. What is the likely outcome of holding an electric eraser over one spot on a drawing for an extended period of time?
1. The eraser motor will burn out
 2. The paper will catch fire
 3. The eraser will bore a hole
 4. The paper will crumble
- 1-19. What grades of pencil are most suitable for making technical drawings?
1. F through 2H
 2. 2B through 6B
 3. B through 3H
 4. 4H through 9H
- 1-20. What grade of pencil lead tends to smear and smudge?
1. 4B
 2. 4H
 3. B
 4. H
- 1-21. To resume drawing on a drawing executed using an F-grade pencil when the humidity was low, what grade pencil should you use now that the humidity is high to counteract the effect of moist air on the drawing paper?
1. 2H
 2. 4H
 3. 6H
 4. 8H

- 1-22. When preparing to draw, holding your pencil under your palm allows you to use what type of wrist or arm action?
1. Controlled and precise
 2. Free flowing
 3. Jerky and sharp
 4. Rapid and circular
- 1-23. When executing warm-up exercises, you should initially spend most of your time on what element?
1. Features
 2. Details
 3. Mass
 4. Tone
- 1-24. How far beyond the wood casing of a pencil should you extend the graphite of a pencil?
1. 1/8 inch
 2. 1/4 inch
 3. 3/8 inch
 4. 1/2 inch
- 1-25. To sharpen a lead pencil to an elliptical point, you should extend the lead to what length before sharpening?
1. 1/8 inch
 2. 1/4 inch
 3. 3/8 inch
 4. 1/2 inch
- 1-26. Which of the following factors influences the line weight of a single pencil stroke?
1. Direction of stroke
 2. Grade of pencil
 3. Paper surface
 4. Lead binder
- 1-27. Why should you place light tones first in a pencil drawing?
1. To keep erasures to a minimum
 2. To gage scale and perspective
 3. To gage tonal quality
 4. To set highlights
- 1-28. What is the main advantage of drawing with a carbon pencil instead of a graphite pencil?
1. The lines are darker and more dense
 2. The lines are more shiny
 3. The lines are more even in resolution
 4. The lines produce a matte finish

- 1-29. What part of a brush entraps pigment and moves it around?
1. Ferrule
 2. Flags
 3. Heel
 4. Butt
- 1-30. On what part of a brush does deterioration of brush bristles begin?
1. Ferrule
 2. Flags
 3. Heel
 4. Butt
- 1-31. What is the definition of a bright brush?
1. A flat brush that has a square-cut tip
 2. A brightly colored brush
 3. A brush used for displaying bright colors
 4. A brush that is flat, broad, and has round corners
- 1-32. What factor determines the amount of hair in a brush?
1. The length of the bristles
 2. The length of the brush
 3. The number on the brush
 4. The ferrule size
- 1-33. What part or characteristic gives a brush its balance?
1. The handle
 2. The ferrule
 3. The size of the bristles
 4. The amount of paint on the bristles
- 1-34. When, if ever, should you trim the tip of a brush?
1. For special applications
 2. When the bristles are clogged
 3. When the ferrule is loose
 4. Never
- 1-35. What procedure should you use to clean a brush containing oil-based pigment?
1. Remove the color with solvent and rinse in lukewarm water
 2. Wet brush in water, lather with soap and rinse with solvent
 3. Wet brush in lukewarm water and work the brush in soapy lather until color disappears
 4. Remove the pigment with water and rinse in lukewarm water
- 1-36. In what position should you store a recently cleaned brush?
1. Bristles up
 2. Handles up
 3. On its side
 4. On the bristles
- 1-37. You should NOT use one set of brushes to work in both oil- and water-based pigments for which of the following reasons?
1. Water-based pigments will not pick-up on the bristles
 2. Oil-based pigments will not pick-up on the bristles
 3. Residual oils may leech into the water-based pigment
 4. Water-based pigments strip bristles of resiliency
- 1-38. What action can you take to help a new pen point hold ink and improve ink flow?
1. Thin the ink
 2. Spray the point with starch
 3. Soak the point overnight in ammonia
 4. Moisten the point to remove the protective oils
- 1-39. To what maximum level should you fill the tip of a pen nib with ink?
1. 3/8 inch
 2. 1/2 inch
 3. 9/16 inch
 4. 1 inch
- 1-40. What type of pen nib should you use to produce extremely fine lines?
1. Lettering
 2. Reservoir
 3. Technical
 4. Quill
- 1-41. What technical pen characteristic ensures correct ink flow?
1. The reservoir
 2. The tubular nib
 3. The gravity-fed needle
 4. The reservoir collar
- 1-42. You should fill the ink cartridge of a reservoir pen to what maximum level?
1. Full
 2. Three-quarters full
 3. Two-thirds full
 4. Half-full

- 1-43. What is the correct angle for holding a reservoir pen relative to the surface of a paper?
1. 16°
 2. 30°
 3. 60°
 4. 90°
- 1-44. When a technical pen is pressed too hard against a straightedge, what type of lines may result?
1. Wavy
 2. Splotchy
 3. Intermittent
 4. Unevenly thick
- 1-45. Normally, you should use what solution to clean pen nibs?
1. Mild detergent and water
 2. Ammonia and water
 3. Vinegar and water
 4. Ammonia and vinegar
- 1-46. In what solution should you soak pen nibs that have dried, stubborn ink encrustations?
1. Caustic soap and water
 2. Ammonia and water
 3. Vinegar and water
 4. Ammonia and water
- 1-47. If you thin ink with water, what ink property is reduced?
1. Quantity
 2. Opacity
 3. Pigment
 4. Color
- 1-48. Which of the following inking techniques is the most effective for creating tone?
1. Scratchboard
 2. Crosshatch
 3. Ross board
 4. Stabilo
- 1-49. When inking a pair of intersecting lines with a pen or brush, what technique should you use to avoid blurring or blotting at the point of intersection?
1. Ease the pressure on the pen or brush as it moves through the point
 2. Apply more pressure on the pen or brush as it moves through the point
 3. Let the first line dry thoroughly before drawing the second line
 4. Draw the second line before the first line dries thoroughly
- 1-50. What type of drawings are ink washes?
1. Line
 2. Tonal
 3. Variation
 4. Continuous-tone
- 1-51. When working with wash, you should perform which of the following procedures first?
1. Set up the wash
 2. Stretch paper over the board
 3. Do a basic drawing
 4. Practice technique
- 1-52. To render quality washes, you should use what type of paper?
1. Saral paper
 2. Tracing paper
 3. Watercolor paper
 4. Hot-pressed paper
- 1-53. Which of the following paper weights do NOT require stretching?
1. 50 lb
 2. 150 lb
 3. 200 lb
 4. 300 lb
- 1-54. You should begin to work on watercolor paper at what point?
1. When the paper is completely dry after wetting
 2. As soon as the paper is wet
 3. When the paper loses its sheen
 4. After you tape the paper onto a surface
- 1-55. To mask areas of a work from a wash, you may use which of the following materials?
1. Cloth tape, liquid frisket, or masking tape
 2. Transparent tape, masking tape, or rubber cement
 3. Masking tape, transparent tape, or paper tape
 4. Masking tape, rubber cement, or liquid frisket
- 1-56. In what respect, if any, do techniques for ink washes differ from the wash technique for water-based pigment?
1. By the layout of the preliminary drawing
 2. By the surface preparation
 3. By the brush selection
 4. None

- 1-57. After applying wash to your illustration board, what tool or material, if any, should you use to soak up the remaining puddle?
1. A brush
 2. A sponge
 3. A wad of cotton
 4. None; let it dry naturally
- 1-58. To paint a graded wash, you should apply pigment in what order?
1. Light to light; light to lighter
 2. Light to dark; dark to light
 3. Dark to light; light to lighter
 4. Dark to light; dark to darker
- 1-59. What is the first step in creating an indefinite blend?
1. Float a wash over the entire area
 2. Float dark tones over the entire area
 3. Paint light tones over the wet area
 4. Paint dark tones over the wet area
- 1-60. Which of the following mediums is composed of carbonized willow twigs?
1. Conte crayon
 2. Charcoal
 3. Crayon
 4. Pastel
- 1-61. Pastel drawings normally progress through which of the following value stages?
1. Dark to light
 2. Light to dark
 3. Light, medium, dark
 4. Dark, light, tonal variations
- 1-62. You added oil chalk highlights to a pastel drawing. Three days later, you notice dark rings around the highlights. What is the cause of these dark rings?
1. Dirt on the drawing surface
 2. Oil from the chalk seeping into the paper
 3. Oil from the pastels seeping into the paper
 4. Turpentine from the blending process seeping into the paper
- 1-63. What action, if any, increases the purity of oil-based pigments?
1. Adding extender
 2. Adding impasto
 3. Adding reducer
 4. None; it is in its purist form in the tube
- 1-64. Which, if any, of the following additives allows a painter to scumble oil-based pigment?
1. Extender
 2. Impasto
 3. Reducer
 4. None
- 1-65. Which of the following substances does NOT provide an appropriate ground for the foundation of an oil painting?
1. Gesso
 2. Lead white
 3. Flake white
 4. Industrial white
- 1-66. Improper grounding causes what area of an oil painting on canvas to deteriorate first?
1. The back
 2. The edges
 3. The front
 4. The stretchers
- 1-67. Oil-based paints over metal substrates take longer to dry than over canvas board or masonite.
1. True
 2. False
- 1-68. What painting procedure causes pigment to curdle after you spray oil-based aerosol pigment over a metal substrate?
1. Spraying lacquer over enamel
 2. Spraying enamel over lacquer
 3. Spraying over cold metal
 4. Spraying over hot metal
- 1-69. To create backgrounds for slide work and portraiture, which of the following oil-based painting techniques should you use?
1. Underpainting
 2. Overpainting
 3. Alla prima
 4. Grisaille

- 1-70. Which of the following terms refers to extreme contrasts in oil painting tonal values when a dark tone has been used as a base color?
1. Toned ground
 2. Scumbling
 3. Grisaille
 4. Glazing
- 1-71. To preserve oil-based pigments at the end of a work day, what short-term method should you use?
1. Immerse the palette in turpentine
 2. Immerse the palette in linseed oil
 3. Immerse the palette in alcohol
 4. Immerse the palette in water
- 1-72. What is the cause of bloom?
1. Improperly cured oil paint
 2. Improperly mixed oil paint
 3. Mixing oil and acrylic paint
 4. Moisture trapped between the oil paint and varnish
- 1-73. What step should you take to impart a semigloss finish to paintings done in an acrylic medium?
1. Add a semigloss extender
 2. Add a semigloss reducer
 3. Mix a gloss and matt extender
 4. Mix a matt and gloss reducer
- 1-74. What characteristic causes cracking in acrylic impasto?
1. An excessive amount of impasto
 2. An excessive amount of pigment
 3. A flexible substrate
 4. The outside skin drying faster than the inside
- 1-75. What substance should you use to clean the surface of an acrylic painting?
1. Soap and water
 2. Coal tar
 3. Petroleum
 4. Turpentine

ASSIGNMENT 2

Textbook Assignment: "Mediums," chapter 1, pages 1-54 through 1-65; and "Color," chapter 2, pages 2-1 through 2-38.

-
- 2-1. What blending technique(s) should you use with acrylic-based paints?
1. Indefinite
 2. Wet brush only
 3. Dry brush only
 4. Either a wet brush or a dry brush
- 2-2. What is/are the purpose(s) of using a varnish to finish an acrylic painting?
1. Protection
 2. Even out surface reflection
 3. Facilitate future cleanings
 4. All of the above
- 2-3. Mixing tap or impure water into water-based pigments causes which of the following problems?
1. Increased grit
 2. Increased adhesion
 3. Reduced opacity
 4. Reduced clarity
- 2-4. As an art student, what watercolor permanence rating should you select for your work?
1. AA
 2. A
 3. B
 4. C
- 2-3. What mixing procedure should you remember when mixing watercolor pigments?
1. Mix in a lot of water
 2. Mix pigments lighter than required
 3. Mix pigments darker than required
 4. Mix white into each color for brightness
- 2-6. Pigment consisting of a binder of gum arabic and precipitated chalk is known by what name?
1. Retouch greys
 2. Watercolors
 3. Gouache
 4. Casein
- 2-7. Which of the following pigment characteristics is not a classification of gouache?
1. Permanence
 2. Staining
 3. Opacity
 4. Clarity
- 2-8. Cheap casein pigments may mold and decompose.
1. True
 2. False
- 2-9. What blending technique requires mixing a third intermediate value?
1. Using wet brush blending
 2. Using dry brush blending
 3. Indefinite blending
 4. Tertiary blending
- 2-10. What theory of light should be the greatest concern for DMs regarding color?
1. Photon
 2. Quantum
 3. Wave motion
 4. Polarization
- 2-11. What element of light theory is the chief determinate of perceived color?
1. Wavelength
 2. Frequency
 3. Speed
 4. Light
- 2-12. What occurs when light strikes a surface?
1. Reflection only
 2. Diffusion and transmission only
 3. Absorption and reflection only
 4. Reflection, diffusion, and transmission
- 2-13. An orderly reflection of light from a smooth or polished surface is known by what term?
1. Glare
 2. Polarization
 3. Specular reflection
 4. Diffused reflection

- 2-14. What term is used to refer to the transmissive properties of clear, textured glass?
1. Transparent
 2. Translucent
 3. Diffused
 4. Opaque
- 2-15. What term refers to the use of filtered vibrating specular reflection to simulate motion?
1. Diffused polarization
 2. Specular polarization
 3. Plane polarization
 4. Polarization
- 2-16. Which color theory describes white light as the presence of all colors?
1. Subtractive
 2. Additive
 3. Process
 4. Spot
- 2-17. Which of the following colors is NOT a spectral primary color?
1. Yellow
 2. Green
 3. Blue
 4. Red
- 2-18. Using the subtractive theory of color, which of the following colors is NOT a primary color?
1. Yellow
 2. Green
 3. Blue
 4. Red
- 2-19. Using the subtractive theory of color, which of the following colors could NOT result from mixing pigments?
1. Orange
 2. Green
 3. White
 4. Brown
- 2-20. What color is the result of mixing all three primaries according to the subtractive color theory?
1. Black
 2. Blue-grey
 3. Brown or grey
 4. Black or brown
- 2-21. What is the result of mixing any two primary colors according to the subtractive theory of color?
1. Grey
 2. Binary color
 3. Primary color
 4. Tertiary color
- 2-22. With a tertiary color, what compound name correctly indicates the predominance of the primary color?
1. Red-orange
 2. Orange-red
 3. Violet-blue
 4. Red-yellow
- 2-23. How many colors are included on a fundamental color wheel?
1. 4
 2. 6
 3. 8
 4. 12
- 2-24. When you are using a color wheel, what defines harmonious color?
1. Colors that contain some part of the colors adjacent to them
 2. Colors located directly opposite each other
 3. Colors mixed with their complement
 4. Colors created using two or more primaries
- 2-25. What is the complimentary color of orange?
1. Red
 2. Blue
 3. Green
 4. Yellow
- 2-26. What is the complimentary color of yellow-green?
1. Red
 2. Violet
 3. Red-Violet
 4. Red-orange
- 2-27. Which of the following characteristics is NOT a dimension of color?
1. Hue
 2. Value
 3. Pigment
 4. Intensity

- 2-28. The three dimensions of color are essential to your success as a DM for what reason?
1. To mix and match colors
 2. To analyze and mix colors
 3. To analyze and match colors
 4. To analyze and mix spectral colors
- 2-29. What term is used to name colors?
1. Hue
 2. Value
 3. Pigment
 4. Intensity
- 2-30. What term refers to the lightness or darkness of a color?
1. Hue
 2. Value
 3. Pigment
 4. Intensity
- 2-31. Adding white or black to a color affects what color characteristic(s)?
1. Hue only
 2. Value only
 3. Intensity only
 4. Value and intensity
- 2-32. What type of color alteration is created when you add white to a color?
1. A hue
 2. A tint
 3. A shade
 4. A secondary
- 2-33. In terms of color, which of the following aspects should be kept consistent throughout your entire picture?
1. All tints and shades
 2. Intensity range
 3. Value range
 4. Hues
- 2-34. What term refers to the saturation of a color?
1. Key
 2. Hue
 3. Value
 4. Chroma
- 2-35. You get a color at its maximum intensity by performing what action?
1. By adding white to the color to create a tint
 2. By adding black to the color to create a shade
 3. By mixing the color with its complement
 4. By using the color straight from the tube
- 2-36. Which of the following methods reduces the intensity and changes the hue of a color?
1. Adding its complement
 2. Adding a harmonious color
 3. Adding white to create a tint
 4. Adding black to create a shade
- 2-37. Without changing value or hue, adding what color changes its intensity?
1. White
 2. Black
 3. Grey
 4. Neutral-grey
- 2-38. What techniques should you use to make small, color, thumbnail roughs?
1. Detail and increased intensity
 2. General shapes and flat tones
 3. Detail and complimentary hues
 4. General shapes and wide value ranges
- 2-39. Achromatic color schemes lack which of the following color characteristics?
1. Hue
 2. Value
 3. Pigment
 4. Intensity
- 2-40. What color scheme refers to a single hue used throughout an entire picture with only variations in value and intensity?
1. Analogous
 2. Achromatic
 3. Monochromatic
 4. Complimentary

- 2-41. Which, if any, of the following colors make up an analogous color scheme?
1. Colors near each other on the color wheel
 2. Colors opposite each other on the color wheel
 3. Secondary colors opposite each other on the color wheel
 4. None of the above
- 2-42. An analogous color scheme should use how many colors on the color wheel?
1. One-third to one-fourth
 2. One-half
 3. Two-thirds to three-quarters
 4. As much off the color wheel as necessary
- 2-43. What strategy can you use to make a particular hue appear dominant in an analogous color scheme?
1. Make the hue the most intense color
 2. Give the hue a dark value
 3. Give the hue a large area
 4. All of the above
- 2-44. What type of accents can help prevent monotony in an analogous color scheme?
1. Complimentary
 2. Harmonious
 3. Monotonous
 4. Analogous
- 2-45. A complimentary color scheme is based on which of the following elements?
1. Similar values
 2. Similar hues
 3. Contrast
 4. Triads
- 2-46. For two complimentary colors to harmonize in an illustration, each color must perform in what manner?
1. To split the intensity of the other color
 2. To create an achromatic color scheme
 3. To share a common color
 4. To neutralize each other
- 2-47. If blue is used as a background, what color should you mix with blue so as not to detract from the center of interest?
1. Green
 2. Grey only
 3. Orange only
 4. Grey or orange
- 2-48. What term describes complimentary colors separated by a true compliment?
1. Complimentary schemes
 2. Analogous schemes
 3. Split compliments
 4. Split triads
- 2-49. If the split compliments are blue-green and blue-violet, what color is the compliment?
1. Blue-violet
 2. Orange
 3. Blue
 4. Red
- 2-50. What term describes color schemes based on three equally separated hues?
1. Analogous scheme
 2. Split compliment
 3. Compliment
 4. Triad
- 2-51. In a triad color scheme, what color choice creates harmony?
1. Using three equally spaced colors
 2. Using the three subtractive primaries
 3. Using three spectral primaries
 4. Using one dominant hue
- 2-52. What is the definition of a set palette?
1. A palette having all pigments necessary to complete a painting
 2. A palette containing only primary colors
 3. A palette with a small amount of one color added to each color
 4. A palette with a complete assortment of commercial pigments

- 2-53. If you are using a set palette and you add the same color to every color except one, what happens?
1. One color is emphasized
 2. Split compliments are formed
 3. Achromatic colors are formed
 4. Monochromatic colors are formed
- 2-54. All hues can be warmed and cooled, respectively, by the addition of which of the following colors?
1. Black and white
 2. Yellow and blue
 3. Grey and white
 4. Blue and brown
- 2-55. The color of an object NOT modified by weather, light, distance, or reflection is known as what type of color?
1. Spot
 2. True
 3. Flat
 4. Natural
- 2-56. You can increase the apparent intensity of a color by placing it in which of the following locations?
1. Beside a harmonious color
 2. Over a white background
 3. Beside an intense color
 4. Beside a greyed color
- 2-62. To create a lustrous effect in a painting, you should take what action?
1. Highlight the painting using soft pink
 2. Reduce the intensity of background and surrounding colors and accent highlights with pure colors
 3. Create an illusion of mistiness by coloring objects with delicate tints and pastels against grey
 4. Increase the intensity of background colors and use various shades of pure colors for highlights
- 2-63. To produce an iridescent effect, what is the simplest method of achieving a grey cast?
1. Use pastels
 2. Add neutral grey to all hues
 3. Create a series of medium grey tints
 4. Mist the painting with translucent pale grey
- 2-64. When using a series of clean tints and equal amounts of medium grey to achieve iridescence, what establishes and fixes the iridescent effect?
1. Pure tint highlights
 2. Three or four steps of grey
 3. Misty spray of opaque pale grey
 4. A general overall grey cast

IN ANSWERING QUESTIONS 2-57 THROUGH 2-60, SELECT THE INTERPRETATION OR FEELING IN COLUMN B WHICH INDIVIDUALS ARE MOST LIKELY TO RELATE TO THE COLOR LISTED IN COLUMN A. RESPONSES IN COLUMN B MAY BE USED MORE THAN ONCE.

- | <u>A. COLORS</u> | <u>B. FEELINGS</u> |
|------------------|--------------------|
| 2-57. Red | 1. Fear |
| 2-58. Black | 2. Brilliance |
| 2-59. Yellow | 3. Sadness |
| 2-60. Green | 4. Safety |
-
- 2-61. To increase picture depth, colors approaching the horizon line should have which of the following characteristics?
1. More purity
 2. More intensity
 3. Less intensity
 4. Less shade
- 2-65. The careful arrangement and soft focus on objects of rich, pure hues with dark values accented by a complimentary color can create which of the following special effects?
1. Luster
 2. Luminosity
 3. Iridescence
 4. Opalescence
- 2-66. Which of the following conditions is NOT a factor in the creation of luminous illusions?
1. Purity
 2. Focus
 3. Size
 4. Hue
- 2-67. Which of the following colors is the easiest color to stain?
1. Red
 2. Blue
 3. Green
 4. Yellow

- 2-68. When mixing an orange color, in what order should you mix the appropriate hues to save pigment?
1. Green into red
 2. Red into yellow
 3. Yellow into red
 4. Yellow into red-violet
- 2-69. How do you produce a broken-color effect?
1. Alternately painting with two colors
 2. Using two jars of water
 3. Using two paint brushes
 4. Dipping into two colors without mixing
- 2-70. What acronym is used to refer to ink colors used in the four-color printing process?
1. RBG
 2. PAN
 3. Flat
 4. CYMK
- 2-71. Which of the following printing processes is the best method to produce printed images without gradations in tone or modulation?
1. Process color printing
 2. Continuous tone
 3. Flat color
 4. Spot color
- 2-72. CEPS scanners have individual photomultiplier tubes to split and record color into spectral primaries plus black.
1. True
 2. False
- 2-73. Which computer hardware feature limits the speed at which your computer can handle color graphics?
1. RAM
 2. ROM
 3. REM
 4. WORM
- 2-74. Which of the following elements is NOT a form of image capture?
1. Grey scale
 2. Color
 3. Line
 4. Page
- 2-75. How many bits per spectral primary should be assigned for a desktop scanner to render more than 16 million colors?
1. 6 bits
 2. 8 bits
 3. 10 bits
 4. 12 bits

ASSIGNMENT 3

Textbook Assignment: "Drawing," chapter 3, pages 3-1 through 3-60.

3-1. When you are drawing, what element that does NOT exist in nature is manipulated?

1. Outline
2. Shape
3. Color
4. Size

IN ANSWERING QUESTIONS 3-2 THROUGH 3-9, SELECT FROM THE FOLLOWING LIST THE TERM DESCRIBED IN THE QUESTION. ANSWERS MAY BE USED MORE THAN ONCE.

DRAWING TECHNIQUES

- | | |
|------------------|----------------------|
| A. Outline | F. Cross contour |
| B. Contour | G. Negative contour |
| C. Bas-relief | H. Inversion contour |
| D. Blind contour | I. Gesture drawing |
| E. Felt contour | J. Drawing through |

3-2. Keeping your eyes on the object you are drawing.

1. A
2. B
3. C
4. D

3-3. Not looking at the drawing or the object while drawing.

1. A
2. B
3. C
4. D

3-4. Develops coordination of the hand, eye, and brain.

1. B
2. D
3. E
4. F

3-5. Develops your perceptions of surface characteristics and hard edges.

1. B
2. D
3. E
4. F

3-6. Develops a sense of spatial relationships.

1. D
2. E
3. F
4. G

3-7. Develops a sense of weight and mass.

1. E
2. F
3. I
4. J

3-8. Helps novice draftsmen draw figures with more realistic proportions.

1. E
2. G
3. H
4. I

3-9. Develops your ability to give objects depth as well as height and width.

1. E
2. B
3. J
4. D

3-10. Inversion contour drawing is a technique that forces you to visually perceive each object from an unfamiliar perspective.

1. True
2. False

3-11. Which of the following shapes is NOT a basic drawing element?

1. Cone
2. Sphere
3. Cylinder
4. Trapezoid

3-12. Changing any dimension of a cube creates which of the following shapes?

1. Hexagon
2. Octagon
3. Rectangle
4. Parallelogram

3-13. A sphere drawn in an isometric projection appears as what shape?

1. An ellipse with an irregular major axis
2. An ellipse with the minor axis on the horizontal plane
3. Round
4. Oval

- 3-14. What factor determines the size of a cone?
1. The diameter of the base
 2. The degree of ellipse at the base
 3. The radius of the circle at the base
 4. The point above or below the base where the lines converge
- 3-15. When you begin a drawing using combinations of basic shapes, which of the following characteristics should be your primary concern?
1. Proportion
 2. Placement
 3. Color
 4. Shape
- 3-16. When drawing illustrations using combinations of basic shapes, what is the last step in the process?
1. Draw in perspective
 2. Define basic shapes
 3. Add details and shading
 4. Transfer the image to paper
- 3-17. Realistic renditions using light, shade, and shadow greatly improve poorly constructed forms.
1. True
 2. False
- 3-18. When evaluating an object's contrast using its background or surroundings, what compositional element is determined?
1. Tone
 2. Value
 3. Color
 4. Pattern
- 3-19. The effects of light, shade, and shadow are known by what term?
1. Tone
 2. Value
 3. Color
 4. Pattern
- 3-20. What is the ideal lighting to define the shape of objects by values instead of lines?
1. Low
 2. Soft
 3. Bright
 4. Medium
- 3-21. Which of the following surfaces reflects images of its surroundings?
1. A window pane
 2. A field of grass
 3. A computer monitor
 4. A sheet of white cardboard
- 3-22. From what direction should you illuminate an object so that it will appear most natural?
1. From the side
 2. From below
 3. From directly above
 4. From above and to one side
- 3-23. To have the most effect on texture, light should strike an object from what direction?
1. Diagonally from above
 2. From directly above
 3. From the side
 4. From below
- 3-24. When beginners draw the basic human figure, they often makes mistakes in which of the following areas?
1. Construction
 2. Proportion
 3. Solidity
 4. All of the above
- 3-25. When drawing the human figure, what technique captures the spontaneity of stance and gesture?
1. Contour
 2. Felt contour
 3. Blind contour
 4. Gesture drawing
- 3-26. The human figure should be drawn using what forms?
1. Cones, cubes, cylinders, and spheres
 2. Modified cones, cubes, cylinders, and spheres
 3. Circles, straight lines, curves, and rectangles
 4. Modified circles, curves, lines, and rectangles
- 3-27. In composite drawing, which element of figure drawing is the basic or first layer?
1. Muscle
 2. Veins
 3. Bone
 4. Skin

3-28. What body part is the standard unit of measure for the human body?

1. Arm
2. Leg
3. Head
4. Foot

3-29. You should draw the average human figure using how many standard units?

1. 7
2. 7 1/2
3. 8
4. 8 1/2

3-30. How many standard units are recommended for drawing the torso of the average human figure?

1. 1/3
2. 2
3. 2 1/3
4. 2 2/3

3-31. What part of the human figure is located at the midpoint of height?

1. Navel
2. Elbow
3. Crotch
4. Small of the back

3-32. How many standard units indicate the width of a female human figure?

1. 1 1/4 units
2. 1 1/2 units
3. 1 3/4 units
4. 2 units

3-33. As a child grows to maturity, a boy's center of gravity shifts from (a) what location to (b) what location?

1. (a) Navel (b) small of back
2. (a) Crotch (b) stomach
3. (a) Hips (b) crotch
4. (a) Waist (b) navel

3-34. During what phase of drawing do the proportions of an illustrated figure change from actual measurement to visual approximation?

1. Evaluation
2. Foreshortening
3. Detail and shading
4. Thumb nail sketching

3-35. What type of joint allows the arm to rotate?

1. Hinge
2. Angle
3. Rotation
4. Ball-and-socket

3-36. Where is the hinge joint located on a human leg?

1. At the pelvis
2. At the ankle
3. At the knee
4. At the foot

3-37. What is the basic shape of the human head?

1. Sphere
2. Square
3. Cube
4. Cone

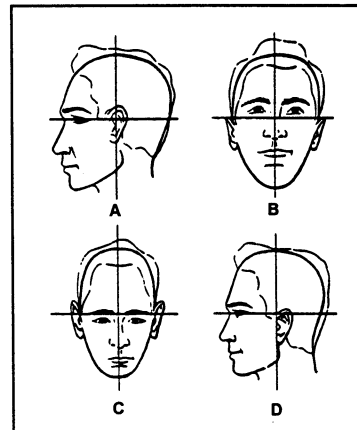

Figure 3A. –Feature positioning.

IN ANSWERING QUESTION 3-38, REFER TO FIGURE 3A.

3-38. Which head is drawn with correctly positioned features?

1. A
2. B
3. C
4. D

3-39. To draw the human head at various attitudes and retain its solidarity and correct features placement, what method should you use?

1. Drawing through
2. Drawing contour
3. Guidelines
4. Contour

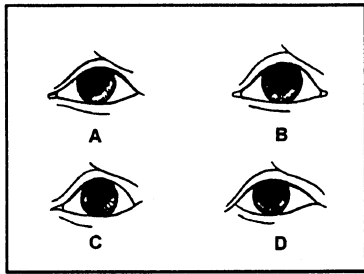

Figure 3B. -Eyelid structures.

IN ANSWERING QUESTION 3-40, REFER TO FIGURE 3B.

- 3-40. Which eye shows correct upper and lower lid structure?
1. A
 2. B
 3. C
 4. D
- 3-41. What causes the distinct highlight in the eye?
1. Light reflection
 2. Eye lids
 3. Moisture
 4. Glasses
- 3-42. Nostril cavities slant in what direction?
1. Horizontally
 2. Vertically
 3. Outward
 4. Inward
- 3-43. What shape is the upper lip?
1. Convex and round
 2. Flat and angular
 3. Round and angular
 4. Convex and sloping
- 3-44. It is normal for the lower teeth to show during which of the following activities?
1. Smiling
 2. Talking
 3. Chewing
 4. Laughing
- 3-45. The four major parts of the ear do NOT include which of the following shapes?
1. Outer and inner rim
 2. Whorl
 3. Bowl
 4. Lobe
- 3-46. A drawing of which of the following figures requires a solid foundation in light, shadow, and shade?
1. Sitting figure
 2. A bodybuilder
 3. Sleeping figure
 4. A baby
- 3-47. Folds in cloth created by gravity, tension, and action subject the cloth to what changes?
1. Layering
 2. Reduction in volume
 3. Condensing
 4. Increases in volume
- 3-48. Most clothing is affected by what type of fold?
1. Action
 2. Gravity
 3. Tension
 4. Support
- 3-49. How and where folds appear in clothing is affected by what factor?
1. Action
 2. Fabric
 3. Body shape
 4. Garment type
- 3-50. Why do folds in a shirt worn by a man differ from folds in a blouse worn by a woman?
1. The blouse has more points of tension than the shirt
 2. The blouse is supported at more points than the shirt
 3. The garments are made of different materials
 4. The garments are different sizes
- 3-51. Where do most folds in a sleeve occur?
1. At the cuff
 2. At the biceps
 3. On the upper side of the arm at the elbow
 4. On the upper side of the arm at the wrist
- 3-52. Folds formed by tension are located at junctions where the human body moves such as at the shoulder-arm junction, leg-torso junction, waist, elbow, and knee.
1. True
 2. False

- 3-53. In what way could seams in the legs of a pair of trousers affect a tension fold?
1. By increasing the folds
 2. By creating action folds
 3. By increasing gravity folds
 4. By terminating folds
- 3-54. What figure attribute communicates an overall mood or emotional message in a drawing?
1. Height
 2. Posture
 3. Clothing
 4. Muscularity
- 3-55. What picture element keeps the viewer in the picture?
1. Color
 2. Borders
 3. Figures
 4. Directional lines
- 3-56. To imply tension in a drawing, how should you place figures?
1. Facing each other
 2. Facing the same direction
 3. Facing away from each other
 4. Facing a third party
- 3-57. What picture element may change the apparent setting of a picture without changing the main characters?
1. Skyline
 2. Horizon line
 3. Background
 4. Foreground
- 3-58. What picture element should you use to proportionately scale all other items in the picture?
1. Trees
 2. Buildings
 3. Machinery
 4. Main figure
- 3-59. When creating a crowd scene, what technique should you use to avoid a monotonous repetition of forms and faces?
1. Show individual variations in emotions
 2. Draw each figure in the crowd in great detail
 3. Show pockets of emotions throughout the crowd
 4. Have the crowd display a unified mood or feeling

ASSIGNMENT 4

Textbook Assignment: "Cartooning and Animation," chapter 4, pages 4-1 through 4-46.

-
- | <p>4-1. Why are cartoons a valuable means of relaying information and advertising?</p> <ol style="list-style-type: none"> 1. They get the message across by being repulsive 2. They turn interesting subject matter into dry learning experiences 3. They show exactly what happens in real life 4. They attract and hold a viewer's attention <p>4-2. What are the two basic forms of cartooning?</p> <ol style="list-style-type: none"> 1. Semi-realistic and caricature 2. Semi-realistic and cartoons 3. Exaggerated and semi-realistic 4. Exaggerated and cartoons <p>4-3. Realistic cartoons fall into which of the following classifications?</p> <ol style="list-style-type: none"> 1. Semi-realistic 2. Exaggerated 3. Caricature 4. Portraiture <p>4-4. When drawing a semi-realistic cartoon, what principle of figure drawing should you apply?</p> <ol style="list-style-type: none"> 1. Exaggeration 2. Expression 3. Proportion 4. Character <p>4-5. Which of the following actions should you NEVER take when drawing cartoons?</p> <ol style="list-style-type: none"> 1. Mixing exaggerated and semi-realistic cartoon types 2. Adding stick figures to characters 3. Mixing semi-realistic types and caricatures 4. Mixing caricatures and cartoons <p>4-6. It is appropriate for you to use a cartoon strip in which of the following static forms?</p> <ol style="list-style-type: none"> 1. In a command newsletter 2. In a change of command brochure 3. On a recruiter business card 4. On a formal invitation | <p>4-7. How should you draw the line for a speech balloon emanating from a cartoon character?</p> <ol style="list-style-type: none"> 1. As an alternating dot and dashed line 2. As a scalloped line 3. As a solid line 4. As a broken line <p>4-8. Which of the following cartoon forms is referred to as roasting?</p> <ol style="list-style-type: none"> 1. Realistic 2. Caricature 3. Exaggerated 4. Semi-realistic <p>4-9. Navy graphics shops commonly use what type of animation technique?</p> <ol style="list-style-type: none"> 1. Cel animation 2. Photoanimation 3. Slide animation 4. Computer animation <p>4-10. Compared to a drafting table, why is a drawing board the better surface for drawing cartoons?</p> <ol style="list-style-type: none"> 1. Thickness 2. Maneuverability 3. Rectangular shape 4. Softwood construction <p>IN ANSWERING QUESTIONS 4-11 THROUGH 4-14, SELECT FROM COLUMN B THE TYPE OF PENCIL USED FOR THE PURPOSE LISTED IN COLUMN A. RESPONSES IN COLUMN B MAY BE USED MORE THAN ONCE.</p> <table border="0" style="width: 100%;"> <thead> <tr> <th style="text-align: left; width: 50%;"><u>A. PURPOSES</u></th> <th style="text-align: left; width: 50%;"><u>B. PENCILS</u></th> </tr> </thead> <tbody> <tr> <td>4-11. Sketching and layout</td> <td>1. 4H</td> </tr> <tr> <td>4-12. Blackening the reverse side of sketching paper</td> <td>2. Brick red</td> </tr> <tr> <td>4-13. Producing halftone effects on rough paper surfaces</td> <td>3. Sky blue</td> </tr> <tr> <td>4-14. Making notes to the printer on tissue overlays</td> <td>4. 6B</td> </tr> </tbody> </table> | <u>A. PURPOSES</u> | <u>B. PENCILS</u> | 4-11. Sketching and layout | 1. 4H | 4-12. Blackening the reverse side of sketching paper | 2. Brick red | 4-13. Producing halftone effects on rough paper surfaces | 3. Sky blue | 4-14. Making notes to the printer on tissue overlays | 4. 6B |
|---|---|--------------------|-------------------|----------------------------|-------|--|--------------|--|-------------|--|-------|
| <u>A. PURPOSES</u> | <u>B. PENCILS</u> | | | | | | | | | | |
| 4-11. Sketching and layout | 1. 4H | | | | | | | | | | |
| 4-12. Blackening the reverse side of sketching paper | 2. Brick red | | | | | | | | | | |
| 4-13. Producing halftone effects on rough paper surfaces | 3. Sky blue | | | | | | | | | | |
| 4-14. Making notes to the printer on tissue overlays | 4. 6B | | | | | | | | | | |

- 4-15. Which of the following pen nibs is most suited to cartoon lettering?
1. Square nibs
 2. Round nibs
 3. Split nibs
 4. Oval nibs
- 4-16. A budding cartoonist should practice drawing cartoons because cartoons help develop which of the following skills?
1. Humor and wit
 2. Hand and eye coordination
 3. Observational and wit
 4. Coordination and observational
- 4-17. What is the first step in creating a successful cartoon?
1. Drawing the torso
 2. Drawing action lines
 3. Selecting the setting
 4. Placing the hands and feet
- 4-18. What technique should you use to draw the basic shape of a cartoon head?
1. Freehand ellipses in sky blue
 2. Freehand ellipses in ink
 3. Use a template ellipse
 4. Draw a square and round the corners
- 4-19. Why are guidelines added to elliptical cartoon heads?
1. To locate features
 2. To perfect the elliptical shape
 3. To divide the ellipse into four equal areas
 4. To divide the ellipse into four unequal areas
- 4-20. Changing what element of a cartoon figure changes the position of the head?
1. Size
 2. Action lines
 3. Shape of the ellipse
 4. Position of the facial guidelines
- 4-21. Changing the position of the head also changes what aspect of the cartoon figure?
1. Emotion
 2. Action
 3. Shape
 4. Size
- 4-22. When drawing a cartoon head, which of the following views shows depth and character?
1. Back view
 2. Side view
 3. Front view
 4. Three-quarter view
- 4-23. Why would you use a side view of a cartoon character's head?
1. To show a classy profile
 2. To subordinate a character
 3. To show depth and character
 4. To develop a direct relationship with the viewer
- 4-24. What is the name of the cartooning technique often used in animation to create audience involvement?
1. Slapstick
 2. Clowning
 3. Mugging
 4. Comedy
- 4-25. Typecasting enables a cartoonist to create character by using which of the following techniques?
1. Distortion
 2. Exaggeration
 3. Combining features
 4. All of the above
- 4-26. Which of the following characteristics typifies traits often associated with a loser?
1. Strong chin
 2. Weary eyed
 3. Bull neck
 4. Wavy hair
- 4-27. Bedy eyes are characteristic of what type of character?
1. Wrestler
 2. Loser
 3. Actor
 4. Hero
- 4-28. Sophisticates are usually portrayed by using what type of character feature(s)?
1. Jug ears
 2. Pug nose
 3. Baldness
 4. Strong chins
- 4-29. What parts of a cartoon head show the most emotion?
1. Eyes and nose
 2. Hair and ears
 3. Mouth and hair
 4. Mouth and eyes

- 4-30. What part of a cartoon face develops character rather than showing expression?
1. Eyebrows
 2. Mouth
 3. Hair
 4. Eyes
- 4-31. When drawing a frightened cartoon figure, how would the hair on the head appear?
1. Tousled
 2. Droopy
 3. On end
 4. Combed
- 4-32. Raised eyebrows on a cartoon head indicate which of the following emotions?
1. Fear
 2. Anger
 3. Relief
 4. Surprise
- 4-33. What facial feature is the most expressive?
1. Eyes
 2. Nose
 3. Chin
 4. Mouth
- 4-34. Facial features on cartoon faces may have more than one interpretation.
1. True
 2. False
- 4-35. You should begin drawing cartoon figures by reducing figures to what four basic forms?
1. Cube, cone, cylinder, and sphere
 2. Cube, triangle, cylinder, and circle
 3. Square, cone, cube, and sphere
 4. Square, triangle, rectangle, sphere
- 4-36. Muscles are NOT drawn on a cartoon character performing which of the following actions?
1. Pushing a car
 2. Drinking a soda
 3. Pulling a big dog
 4. Lifting a large box
- 4-37. What principle of perspective, used in cartoon drawing, diminishes an object in size and proportion?
1. One-point perspective
 2. Foreshortening
 3. Proportioning
 4. Reduction
- 4-38. What drawing technique enables you to place the arms and legs on a cartoon figure?
1. Drawing the hands and legs on overlays
 2. Drawing through the hands and legs as if they were transparent
 3. Drawing hands and legs on separate paper and pasting into place
 4. Mathematically calculating the exact location of the hands and legs
- 4-39. Hands are capable of showing emotion.
1. True
 2. False
- 4-40. What method is used to draw a cartoon hand?
1. Draw the basic form as a two piece element, add the thumb, and draw the detail
 2. Reduce the hand to a five-piece element, then draw in the fingers
 3. Draw the hand a silhouette with the fingers well separated
 4. Make a copy of your hand, then erase two fingers
- 4-41. When drawing a cartoon figure, what basic forms should you use to construct the feet?
1. Block only
 2. Cylinder only
 3. Wedge only
 4. All of the above
- 4-42. Why are cartoons involving animals so successful?
1. Animals are believable
 2. Animal shapes are well known
 3. Animals are readily distorted
 4. People relate to animals and give them human-like qualities

4-43. Which of the following shapes is most often used in drawing animal bodies?

1. Ellipse
2. Circle
3. Sphere
4. Oval

4-44. What picture element is subordinate to the main cartoon figure?

1. Props
2. Hands
3. Heads
4. Action

IN ANSWERING QUESTION 4-45, USE FIGURE 4-34 IN THE TEXT.

4-45. Which of the following is NOT a prop?

1. The sign
2. The doctor
3. The syringe
4. The bodies on the floor

4-46. In drawing a costume that will enhance your cartoon figure, you first match the costume to the figure. Which of the following techniques should you use next?

1. Show clothing patterns in detail and draw the costume to fit the contour of the body
2. Show clothing patterns moving in the same direction as the body lines and draw the costume to fit the contour of the body
3. Use simple patterns to indicate, but not draw, every line of each pattern
4. Show detailed clothing patterns and draw the costume loosely

4-47. Why should you use thumbnail sketches to draw settings in a cartoon?

1. To select the main figure
2. To determine the best view
3. To determine tonal areas
4. Both 2 and 3 above

4-48. Which of the following cartoon elements should NEVER serve as props?

1. Clothing
2. Foreground
3. Background
4. Cartoon figures

4-49. Using too many props has what effect, if any, on the action figure in a cartoon?

1. Subordinates it
2. Eliminates it
3. Supports it
4. None

- A. Sketch the figure
- B. Place the hands and feet
- C. Sketch action lines
- D. Use basic forms to add body parts
- E. Add clothing and props

4-50. The steps for drawing cartoon figures are listed above. Which of the following arrangements best describes the correct order for you to follow?

1. B, C, D, A, E
2. C, D, A, B, E
3. A, C, B, D, E
4. C, A, D, E, B

4-51. Which of the following techniques contributes most toward developing a personal cartoon style?

1. Knowledge
2. Training
3. Practice
4. Technique

ASSIGNMENT 5

Textbook Assignment: "Lettering," chapter 5, pages 5-1 through 5-53.

-
- | | |
|---|---|
| <p>5-1. What term is synonymous with hand lettering?</p> <ol style="list-style-type: none">1. Freehand drawing2. Typography3. Printing4. Leroy | <p>5-8. What unit of measure specifies the height of a character?</p> <ol style="list-style-type: none">1. Points2. Inches3. Picas4. Millimeters |
| <p>5-2. What is another term for mechanically produced type intended for subsequent printing?</p> <ol style="list-style-type: none">1. Freehand drawing2. Typography3. Printing4. Leroy | <p>5-9. How should you measure the height of a letter?</p> <ol style="list-style-type: none">1. From the top of the capital to the bottom of the capital2. From the top of the lowercase body to the bottom of the lowercase descender3. From the top of the capital to the bottom of a lowercase descender4. From the top of the capital to the top of the lowercase body |
| <p>5-3. What lettering style should you use on technical drawings and blueprints?</p> <ol style="list-style-type: none">1. Helvetica2. Franklin gothic3. Microgamma bold4. Single-stroke gothic | <p>5-10. What is a major advantage of typesetting text in an electronic format?</p> <ol style="list-style-type: none">1. Speed2. Cleanliness3. Scalable fonts4. Point and pixel equality |
| <p>5-4. What form of lettering is calligraphy?</p> <ol style="list-style-type: none">1. Freehand drawing2. Typography3. Printing4. Leroy | <p>5-11. A letter's x-rating most closely identifies the position of what lettering guideline?</p> <ol style="list-style-type: none">1. Capline2. Waistline3. Baseline4. Line of descension |
| <p>5-5. The visual presentation of a letter style is known by what term?</p> <ol style="list-style-type: none">1. Type font2. Type series3. Typeface4. Type family | <p>5-12. Manipulating the spacing between letters in a line is referred to by what term?</p> <ol style="list-style-type: none">1. Kerning2. Line spacing3. Font metrics4. Letterspacing |
| <p>5-6. The complete collected alphabet in one particular style including punctuation marks is referred to by what term?</p> <ol style="list-style-type: none">1. Type font2. Type series3. Typeface4. Type family | <p>5-13. Space occupied by typeset letters is measured by what unit of measurement?</p> <ol style="list-style-type: none">1. Point2. Pixel3. EN-square4. EM-square |
| <p>3-1. Typefaces that are similar, although not exactly alike in design, are grouped into what category?</p> <ol style="list-style-type: none">1. Typefaces2. Type styles3. Type families4. Type characteristics | <p>5-14. What term refers to the reduction of space between letters?</p> <ol style="list-style-type: none">1. Kerning2. Line spacing3. Font metrics4. Letterspacing |

- 5-15. What name refers to the partially enclosed white space created by the arms of an E or F?
1. Bowl
 2. Counter
 3. Crossbar
 4. Ascender
- 5-16. How far up from the baseline of a letter should you place the waistline?
1. One-half the distance from the baseline to the capline
 2. Two-thirds the distance from the baseline to the capline
 3. One-fourth the distance from the capline to the baseline
 4. Three-fourths the distance from the capline to the baseline
- 5-17. Which of the following actions increases legibility without changing point size or line length?
1. Selecting a larger letter
 2. Adding space-between letters
 3. Removing space between letters
 4. Increasing the height of the x-rating
- 5-18. Which of the following ascending letters should you draw terminating below the capline?
1. d
 2. f
 3. t
 4. h
- 5-19. Why should rounded letter forms be drawn to slightly extend over the basic letter guidelines?
1. To emphasize their form
 2. To give them visual weight
 3. To create the illusion of equality
 4. To draw attention away from font metrics
- 5-20. What device should you use to keep hand drawn letters horizontally in line?
1. Ascenders
 2. Descenders
 3. Guidelines
 4. Directional lines
- 5-21. What guidelines should you draw to letter the words "US Navy," using both upper- and lower-case letters?
1. Capline and baseline only
 2. Capline, baseline, and drop line only
 3. Capline, waistline, and drop lines only
 4. Capline, waistline, baseline, and drop line
- 5-22. What guideline indicates the height of the body on a lowercase letter H?
1. Waistline
 2. Baseline
 3. Drop line
 4. Capline
- 5-23. When drawing guidelines for freehand lettering, the vertical distance from the drop line to the baseline should equal what distance?
1. One-half the distance between the drop line and the waist line
 2. 1 1/2 inch
 3. One-third the distance from the baseline to the capline
 4. Twice the distance from the baseline to the waistline
- IN ANSWERING QUESTIONS 5-24 THROUGH 5-26, ASSUME YOU ARE PREPARING THE GUIDELINES FOR A FREEHAND LETTERING JOB THAT REQUIRES 2 1/4 - INCH CAPITAL LETTERS.
- 5-24. What is the distance between the capline and the drop line?
1. 1 1/2 inches
 2. 2 inches
 3. 3 inches
 4. 2 1/4 inches
- 5-25. What is the distance between the baseline and the waistline?
1. 1 inch
 2. 3/4 inch
 3. 1 1/2 inch
 4. 2 1/4 inch
- 5-26. What is the (a) maximum angle of the direction lines for inclined lettering and (b) how far apart should the lines be spaced?
1. (a) 68 degrees (b) 1 inch
 2. (a) 68 degrees (b) random
 3. (a) 74 degrees (b) 1 inch
 4. (a) 74 degrees (b) random

- 5-27. What letter weight reproduces at maximum legibility?
1. Lightface
 2. Openface
 3. Boldface
 4. Regular
- 5-28. The geometric symmetry of typefaces is exposed by examining what letter?
1. Q
 2. M
 3. O
 4. W
- 5-29. What is the purpose of serifs on roman letters?
1. To connect the letters
 2. To decorate the letters
 3. To lend unity to words
 4. To lend unity and blend the letters together for easy reading
- 5-30. Which of the following typefaces is an example of old style roman letters?
1. Bodoni
 2. Century
 3. Caslon
 4. Caisson
- 5-31. Which of the following lettering styles gives the impression of stateliness?
1. Basic script
 2. Roman
 3. Cursive
 4. Formal script
- 5-32. What action, if any, should you take to avoid making gothic letters appear denser than they should?
1. Photographically reduce the letters
 2. Thin the strokes slightly where they join stems and curves
 3. Use a smaller pen point to join strokes
 4. None; the gothic typeface is supposed to be heavy
- 5-33. The gothic typeface is used chiefly for what type of work?
1. Text
 2. Emphasis
 3. Display
 4. Wedding announcements
- 5-34. What does the term "san serif" mean?
1. No serifs
 2. Original serifs
 3. Geometric serifs
 4. Square serifs
- 5-35. What is the purpose of kerns?
1. To join the main stems of adjacent letters
 2. To show uniformity in direction
 3. To show the difference between upsweeps and main stems
 4. To show the difference between uppercase and lowercase -script letters
- 5-36. The script family is mainly used for what type of work?
1. Imitating old-fashioned hand lettering
 2. Invitations
 3. Religious or formal layouts
 4. Display work
- 5-37. Cursive letters do NOT have kerns.
1. True
 2. False
- 5-38. Additional swirls and curves ornament what family of letters?
1. Script
 2. Swash
 3. Italics
 4. Old english
- 5-39. When using text typefaces, why should you avoid using all capital letters in words?
1. Words consisting of all caps detract from the main body of type
 2. Words consisting of all caps are almost illegible
 3. All caps tire the reader's eye
 4. The use of lowercase text is universal practice
- 5-40. Which of the following typefaces is the most versatile and can be used almost anywhere?
1. Italic
 2. Gothic
 3. Futura
 4. Roman
- 5-41. In layouts, italics are used for what purpose?
1. Display
 2. Text
 3. Incidental information
 4. Emphasis

- 5-42. What type of letters are constructed with lines of even weight?
1. Roman
 2. San serif
 3. Gothic
 4. Contemporary
- 5-43. The square serif and san serif typefaces have what characteristic in common?
1. The shape of the serif
 2. Their streamlined appearance
 3. They are kerned
 4. Even strokes and geometric proportions
- 5-44. Contemporary typefaces are used in which of the following types of layouts?
1. Display
 2. Formal
 3. Religious
 4. Announcement
- 5-45. Why is the chisel-pointed carpenter's pencil used to draw roman face letters?
1. It is sturdier than a conical-pointed pencil
 2. The pencil is held in one position to create the thin-and-thick strokes
 3. Serifs are only made with a chisel-pointed pencil
 4. Carpenter's pencils can only be sharpened to a chisel point
- 5-46. Lettering should be considered an integral part of the overall composition of a layout.
1. True
 2. False
- 5-47. A page layout is 10-inches square with 1-inch left and right margins and a geometric center at point x. The optical center of the layout is located at what point?
1. On point X
 2. One inch above point x
 3. One inch below point x
 4. One inch to the left or right of point X
- 5-48. To receive maximum attention, at what location should you place an element of a lettering composition?
1. At the optical center of the page
 2. At the top of the page only
 3. At the center of the page only
 4. At either the top or center of the page
- 5-49. What type of layout adds interest and motion to copy?
1. Off-center
 2. Formal
 3. Inverted pyramid
 4. Informal
- 5-50. When freehand lettering, what factor(s) has/have the greatest effect on legibility?
1. The style of letters
 2. The size of letters
 3. Space between letters, lines, and words
 4. All of the above
- 5-51. What maximum number of letter styles should you use for textural layouts?
1. 1
 2. 2
 3. 3
 4. 4
- 5-52. How can you achieve interest and focus in layouts with excessive text?
1. Vary the typefaces
 2. Vary the type sizes
 3. Eliminate words
 4. Add pictures
- 5-53. Why is letterspacing of lowercase letters used with caution?
1. It reduces legibility
 2. It reduces white space
 3. It extends letters
 4. It extends line length



Figure 5A. -Letterspacing.

REFER TO FIGURE 5A TO ANSWER QUESTIONS 5-54 AND 5-55. THE WORD "SPACING" WRITTEN ABOVE HAS BEEN MECHANICALLY DRAWN WITH EQUAL SPACES BETWEEN LETTERS AND NO FORM OF OPTICAL ADJUSTMENT.

- 5-54. In which areas is there too much air space between the letters?
1. A and F
 2. B and E
 3. A and B
 4. B and C
- 5-55. Which area shows the combination of letter structures where moving the letters farther apart could solve a spacing problem?
1. A
 2. B
 3. E
 4. F
- 5-56. To make equal spaces between words, you should observe what practice?
1. Measure each space with a scale
 2. Use the letter P as a guide
 3. Make each space equal to 1 inch
 4. Use the letter O as a guide
- 5-57. When spacing lines of lettering, you should use what general rule?
1. Use one-half inch between all lines
 2. Use one-third letter height between lines
 3. Use two-thirds letter height between lines
 4. Use the full letter height between lines
- 5-58. Adjusting letter and word spacing to fit lines of lettering to a specified line length is known by what term?
1. Line spacing
 2. Justification
 3. Centering
 4. Word spacing
- 5-59. What factor should you consider when creating overlapping or negative letter forms?
1. Style
 2. Overlap
 3. Legibility
 4. Visual impact
- 5-60. What type of lettering surface should you use when lettering in pen and ink?
1. Medium-surface bristol board.
 2. Smooth-surface bristol board
 3. Ross board
 4. Coquille board
- 5-61. Your choice of pencil for hand lettering is most affected by which of the following factors?
1. The amount of lettering
 2. The size of the letters
 3. The amount of tooth in the paper
 4. The color of the paper
- 5-62. What type of pencil should you use to create large letters?
1. A hard pencil
 2. A drawing pencil
 3. A carpenter's pencil
 4. A soft pencil
- 5-63. To create roman letters with a carpenter's pencil, you should hold the pencil lead to the paper at what angle?
1. 30 degrees
 2. 35 degrees
 3. 40 degrees
 4. 45 degrees
- 5-64. Gripping a lettering pen too tightly will affect your work in which of the following ways?
1. You will make a broad stroke
 2. You can achieve intricate detail
 3. Your hand will cramp
 4. You will lose the sense of feel necessary to create proper letter forms
- 5-65. What type of lettering brush has round ferrules and flat tips?
1. Trigger
 2. Rigger
 3. Steel
 4. Bright
- 5-66. What size brush should you select for single-stroke lettering?
1. One equal to the width of the desired stroke
 2. A small red-sable brush
 3. One-eighth inch smaller than the desired stroke
 4. One-half the width of the desired stroke

- 5-67. For what reason, if any, is the two-finger hold on a lettering brush preferable to the pencil grip?
1. Improved maneuverability on curved strokes
 2. Allows serif to be made more easily
 3. Improved straight strokes
 4. None, the pencil grip is more versatile
- 5-68. When making single-stroke brush lettering, what step should you take after filling the brush with paint?
1. Spread the brush beyond its normal width
 2. Palette the brush on illustration board to position the load
 3. Shape the brush tip into a round point
 4. Begin lettering
- 5-69. What should you do to prevent smearing letters made with soft, smudgy media, such as charcoal and pastels?
1. Spray the finished work with fixative
 2. Burnish the letters
 3. Moisten the drawing surface
 4. Spray the paper with fixative before lettering
- 5-70. Mechanical lettering guides have an advantage over freehand lettering with respect to which of the following elements?
1. Working speed
 2. Letter and number uniformity
 3. Spacing uniformity
 4. All of the above
- 5-71. What pin on the lettering scribe should you place in the large groove at the bottom of the template?
1. Tracing pin
 2. Cleaning pin
 3. Scribing pin
 4. Tail pin
- 5-72. What problem is created by excessive hand pressure on a lettering scribe?
1. No ink is deposited
 2. Too much ink is deposited
 3. Grooves or holes are dug into the paper
 4. The flow pin in the pen nib bends
- 5-73. Which of the following printers is NOT suitable for outputting letters for subsequent reproduction?
1. Laser printers
 2. Thermal printers
 3. Dot matrix printers
 4. Computer-generated printers
- 5-74. When selecting type size, what is the most important aspect of computer-generated letter forms?
1. Printing industry points and pixels are the same
 2. Computer-generated points and dots are the same
 3. Pixels and dots are not the same
 4. Printing industry points and computer-generated points are not the same
- 5-75. What is a major disadvantage of using pressure process transfer lettering?
1. Running out of frequently used characters
 2. Having the size and style available
 3. Having black letters
 4. Dryness

ASSIGNMENT 6

Textbook Assignment: "Lettering," chapter 5, pages 5-54 through 5-65; and "Airbrush," chapter 6, pages 6-1 through 6-58.

- 6-1. Beautiful hand lettering is also known by what term?
1. Hand lettering
 2. Printing
 3. Typography
 4. Calligraphy
- 6-2. Calligraphic capital letters are also referred to by what term?
1. UC
 2. Uppercase
 3. Majuscule
 4. Minuscule
- 6-3. Calligraphic lowercase letters are also referred to by what term?
1. LC
 2. Lowercase
 3. Majuscule
 4. Minuscule
- 6-4. What is the term used for calligraphic letters drawn with more flourishes and embellishments than letters typical to that family?
1. Majestic
 2. Decorated
 3. Illuminated
 4. Embellished
- 6-5. In calligraphic lettering, straightening the forefinger during lettering indicates which of the following problems?
1. Gripping the pen too low
 2. Gripping the pen too high
 3. Excessive pressure between the pen nib and paper
 4. Excessive pressure between the thumb and forefinger
- 6-6. What guideline assists in the placement of kerns?
1. Capline
 2. Waistline
 3. Branch line
 4. Baseline
- 6-7. In calligraphic lettering, how is the distance between guideline placement determined?
1. By letter height
 2. By mathematical equation
 3. By penwidth ratio
 4. By arbitrary selection
- 6-8. What method is used to accustom you to letter spacing of calligraphic letters?
1. n-chain
 2. m-chain
 3. o-chain
 4. s-chain
- 6-9. In what form do vertical guidelines appear in calligraphy in-the-round formats?
1. As inclined lines
 2. As vertical lines
 3. As horizontal lines
 4. As radii
- 6-10. DMs use airbrushes to apply paint in what manner?
1. In sharp, tonal contrasts
 2. In bright, opaque tones
 3. In discernable, pastel tints
 4. In soft, tonal gradations
- 6-11. By adjusting the nozzle of single-action airbrushes, what action are you regulating?
1. The volume of air passing through the airbrush only
 2. The amount of fluid flow only
 3. The amount of fluid flow and the volume of air passing through the airbrush
 4. The pattern of fluid sprayed
- 6-12. Using a properly adjusted single-action airbrush, you can vary spray patterns by which of the following methods?
1. Speeding up the brush movements
 2. Readjusting the paint control lever
 3. Changing the distance between the airbrush and paper
 4. Re-covering a painted area
- 6-13. When using double-action airbrushes, depressing the finger lever causes what result?
1. Releases air only
 2. Releases fluid only
 3. Releases air and fluid
 4. Releases more air and increases fluid

- 6-14. When pulling the finger lever of a double-action airbrush farther back, what action results?
1. More air mixes with the pigment
 2. More air diverts away from the nozzle
 3. More pigment leaves the airbrush
 4. More pigment leaves the airbrush in a finer pattern
- 6-15. You may vary the spray pattern made by double-action airbrushes by using which of the following methods?
1. Increasing or decreasing the distance between the brush and paper
 2. By setting the adjustment screw
 3. By using lesser amounts of air
 4. By using lesser amounts of pigment
- 6-16. How do you make double-action airbrushes work like single-action airbrushes?
1. By setting the adjustment screw
 2. By pulling the finger lever all the way back
 3. By decreasing the air flow
 4. By using a second lever
- 6-17. When using double-action airbrushes, three distinct motions must be controlled and coordinated. What action results when these motions run together?
1. An uneven spray pattern throughout the stroke
 2. A sudden burst of fluid at the beginning of the stroke
 3. An even spray pattern throughout the stroke
 4. A sudden burst of pigment at the end of the stroke
- 6-18. When using oscillating airbrushes, what procedure provides better spray control?
1. Slow hand movement
 2. Large ink supply
 3. Slow needle action
 4. A strainer in the pigment cup

IN ANSWERING QUESTIONS 6-19 THROUGH 6-22, SELECT FROM COLUMN B THE TYPE OF AIRBRUSH USED FOR THE TYPE OF WORK IN COLUMN A. RESPONSES IN COLUMN B MAY BE USED MORE THAN ONCE.

| | <u>A. TYPES OF WORK</u> | <u>B. AIRBRUSHES</u> |
|-------|---|------------------------------|
| 6-19. | General purpose work | 1. Oscillating |
| 6-20. | Pictorial rendering | 2. Double-action |
| 6-21. | Heavy-bodied pigments | 3. Single-action |
| 6-22. | Large backgrounds | 4. Oscillating triple-action |
| <hr/> | | |
| 6-23. | What is a recommended technique for operating airbrushes? | |
| | <ol style="list-style-type: none"> 1. Hold the airbrush 8 inches above and at a 90-degree angle to the paper surface 2. Hold the airbrush at a 45-degree angle to the paper and spray the edge of the paper 3. Hold the airbrush 8 inches above the paper and use two quick simultaneous hand motions to begin the spray 4. Hold the airbrush 5 inches above the paper surface and turn your wrist for darker tones | |
| 6-24. | Which of the following airbrushes is best suited for portraiture and photographic retouching? | |
| | <ol style="list-style-type: none"> 1. Single-action 2. Double-action 3. Poster 4. Oscillating | |
| 6-25. | What type of airbrush requires the least amount of air pressure and is less likely than other airbrushes to clog? | |
| | <ol style="list-style-type: none"> 1. Air-fed 2. Pressure-fed 3. Gravity-fed 4. Siphon-fed | |

- 6-26. If an air compressor is not available, what kind of pressurized gas can you use to operate an airbrush?
1. Acetylene
 2. Oxygen
 3. Carbon dioxide or another inert gas
 4. Propane or another low-pressure gas
- 6-27. What factor controls and maintains a steady air flow to an airbrush?
1. Electrical current
 2. Compressor
 3. Gas container
 4. Air pressure regulator
- 6-28. What is the normal range of air pressure for operating an airbrush?
1. 14-16 PSI
 2. 17-24 PSI
 3. 25-30 PSI
 4. 31-35 PSI
- 6-29. If you are working in an area of high humidity, what additional device should you attach to an airpainting system?
1. An air pressure regulator
 2. A siphon-fed color cup
 3. A moisture trap
 4. A pigmentation screen
- 6-30. What is the major cause of an airbrush breakdown?
1. Moisture in compressed air
 2. Foreign matter in fluids
 3. Improper hose connections
 4. Paint clogs
- 6-31. You should remedy clogged air passages in airbrushes by what method?
1. Cleaning the airbrush
 2. Increasing the air flow
 3. Tightening the air hoses
 4. Installing a moisture trap
- 6-32. What product will prevent pigment encrustation on the threads of the nozzle?
1. Oil
 2. Alcohol
 3. Naval jelly
 4. Petroleum jelly
- 6-33. When cleaning airbrushes that use bottle pigment containers, what method should you use to return the pigment inside the brush to the bottle?
1. Reverse the air pressure
 2. Remove the bottle pigment container and spray the remaining pigment back into the container
 3. Hold a sponge tightly against the nozzle of the airbrush and depress the finger lever
 4. Remove the bottle container and pour the remaining pigment back into the bottle
- 6-34. To see if the airbrush needle is properly seated, what should you remove first?
1. The handle
 2. The pigment cup
 3. The air hose
 4. The needle seat
- 6-35. When replacing the needle of an airbrush, you should take what action to seat the needle in the nozzle tip?
1. Connect the air hose
 2. Push the finger lever forward
 3. Remove the moisture trap
 4. Remove the nozzle
- 6-36. What problem is caused by leaking air-hose connections?
1. Spitting moisture
 2. Intermittent spray
 3. Failure to spray
 4. Excessive spray
- 6-37. Which of the following actions corrects an airbrush that fails to spray?
1. Decreasing the air supply
 2. Installing a moisture trap
 3. Cleaning the lid of the pigment bottle
 4. Thinning the pigment with an appropriate solvent
- 6-38. Before flowing pigment through an airbrush, you should take which of the following actions?
1. Thin and mix the pigment well
 2. Thin and strain the pigment through a fine mesh cloth
 3. Mix and strain the pigment through a fine mesh cloth
 4. Strain the pigment through a fine mesh cloth

- 6-39. What solvent should you use to clean watercolors from an airbrush?
1. Vinegar
 2. Alcohol
 3. Acetone
 4. Water
- 6-40. To avoid warping, and before airpainting on light ply substrates, you should take what action?
1. Coat the substrate with lacquer or enamel
 2. Mount or support the substrate
 3. Soak the substrate in water
 4. Brush a layer of rubber cement on the substrate
- 6-41. How can you achieve a textured effect with an airbrush?
1. Use rough textured paper and spray at an angle less than 90 degrees to the paper surface
 2. Use a smooth-textured paper and spray at right angles to the paper surface
 3. Either 1 or 2 above, depending on personal preference
 4. Use an unstrained or heavy-bodied pigment and spray at a 45-degree angle to the paper surface
- 6-42. Before airpainting, you should place a mask over the illustration for what reason?
1. To transfer a pattern to the board
 2. To keep the board from warping
 3. To produce a textured effect
 4. To protect areas to remain unpainted
- 6-43. Before airpainting complicated illustrations, you should place a cut frisket over the illustration for what reason?
1. To transfer a pattern to the board
 2. To keep the board from warping
 3. To produce a textured effect
 4. To protect areas you do not want painted
- 6-44. To prevent paint from being sprayed under the frisket, what element should you remove?
1. Air bubbles
 2. Rubber cement
 3. Residue paper
 4. Leftover frisket
- 6-45. What information should appear on thumbnail sketches intended for airbrush illustration?
1. Notes for reproduction
 2. Size calculations
 3. Crop marks
 4. Desired colors and shading
- 6-46. To airbrush an even, dark tone, you should take which, if any, of the following actions?
1. Use darker paint
 2. Start from the bottom and work toward the top
 3. Repeat the even tone as-many times as necessary to create the tone desired
 4. None of the above
- 6-47. In an airbrushed field of even tone, you should take what action to create depth?
1. Use opaque pigment
 2. Build up successive layers of pigment
 3. Leave white space showing around the borders
 4. Airbrush a darker tone in the center of the field
- 6-48. To airpaint graduated tones, what method should you use?
1. Work from light to dark
 2. Work from left to right
 3. Work from right to left
 4. Work from dark to light
- IN ANSWERING QUESTION 6-49, REFER TO FIGURE 6-21 IN THE TEXT.
- 6-49. To create spot effects similar to the one shown, you should take which of the following steps?
1. Spray across corners several times to deposit most of the pigment on the mask
 2. Bend your wrist upward to fade off the spray pattern
 3. Paint a light tone at the edges of the mask to join the corners
 4. Each of the above
- 6-50. What is the most important factor in producing successful airbrush renderings of metallic effects?
1. Local color
 2. Intense light conditions
 3. Surface reflections
 4. Sharp contrasts between light and dark tones

- 6-51. In airbrushing metallic effects, which of the following elements adds to a three-dimensional appearance?
1. Sharp contrasts
 2. Sharply defined lines
 3. Shadow areas
 4. Black pigment
- 6-52. What effect is the result of too little air pressure passing through the airbrush?
1. A fine spray
 2. Granulation
 3. A large spray
 4. Reticulation
- 6-53. Raising a mask from the paper surface results in what effect?
1. Granulation
 2. Reticulation
 3. A soft edge
 4. Overspray
- 6-54. In airpainting, holding the brush too close to the paper surface gives what creative result?
1. Centipedes
 2. Shiny surfaces
 3. Runs
 4. Warping
- 6-55. To airpaint geometric shapes having several graded values, you should take what step after placing the frisket over the paper?
1. Turn the paper so the darkest plane is in front of you
 2. Turn the paper so the darkest corner is near you
 3. Turn the paper so the lightest corner is near you
 4. Turn the paper so the lightest plane is in front of you
- 6-56. Why should you begin airpainting the darkest plane of a geometric shape first?
1. For convenience
 2. To gauge values
 3. For uniformity
 4. To use the most pigment first
- 6-57. When airpainting a sphere, what tone should you paint first?
1. Graduated
 2. Dark
 3. Very light
 4. Tone in the highlights
- 6-58. When airpainting spheres, what type of stroke should you use?
1. Short strokes in one direction
 2. Long strokes to the right
 3. Short strokes to the right
 4. Short circular strokes
- 6-59. When painting a cylinder, what tone should you apply first?
1. Graduated
 2. Dark
 3. Light
 4. Tone in the highlights
- 6-60. When pictorial rendering with an airbrush, what should be your first step?
1. Airpaint the farthest background area
 2. Transfer the layout to an illustration board
 3. Airpaint the foreground
 4. Airpaint the detail
- 6-61. When pictorial rendering with an airbrush, what areas are applied by hand?
1. Flat tones
 2. Background shadows
 3. Middle ground shadows
 4. Details
- 6-62. Highlights in pictorial rendering are usually applied with what tool?
1. Airbrush
 2. Hand brush
 3. Moist cloth
 4. Fingertip
- 6-63. An airbrush is used in technical artwork for which, if any, of the following reasons?
1. Flexibility and ease of control
 2. Shading and obtaining sharp edges
 3. Ability to render intricate areas
 4. None of the above
- 6-64. When airpainting technical drawings, what is the next step once the outline is complete?
1. Make a detail drawing of the object
 2. Make a detailed drawing to indicate shading
 3. Use the formula for shading basic forms
 4. Trace the outline onto a sheet of illustration board

- 6-65. Why is it often necessary to touch-up frisket outlines with black pigment?
1. Removing the frisket sometimes removes the outlines
 2. The outline is indistinguishable from shading
 3. All frisket cutting is done on the black outline
 4. The outlines appear white
- 6-66. To prepare photographic surfaces for retouching, what material should you use?
1. Fuller's Earth
 2. An ABC pad
 3. Water
 4. A kneaded eraser
- 6-67. To keep smudges from the surface of photographs being retouched, what material or item should you use?
1. Fuller's Earth
 2. A sheet of paper under your hand
 3. A frisket
 4. A mask
- 6-68. What tool should you use to correct errors and remove overspray from photographs you are retouching?
1. Small cotton wad
 2. Sponge
 3. Steel wool
 4. Kneaded eraser

ASSIGNMENT 7

Textbook Assignment: "Photography," chapter 7, pages 7-1 through 7-40.

- 7-1. Detailed scheduled maintenance for camera equipment may be found in what publication?
1. PMS cards
 2. PH Basic
 3. Shop procedures
 4. MSDS sheets
- 7-2. Why is it important to remove the batteries from cameras?
1. To use the batteries in other units
 2. To place the batteries in cold storage
 3. To keep the batteries from exploding
 4. To prevent swollen batteries from leaking into the cameras
- 7-3. What plane is NOT part of a camera system?
1. The copy plane
 2. The parallel plane
 3. The lens plane
 4. The focal plane
- 7-4. The scene being photographed is said to exist in what plane?
1. The copy plane
 2. The film plane
 3. The lens plane
 4. The focal plane
- 7-5. Enlargements or reductions are generally accomplished by moving what plane?
1. The parallel plane
 2. The film plane
 3. The lens plane
 4. The focal plane
- 7-6. What plane is also known as the film plane?
1. The copy plane
 2. The parallel plane
 3. The lens plane
 4. The focal plane
- 7-7. The image size is altered by adjusting what camera component?
1. Scales
 2. Aperture rings
 3. Shutter speed dials
 4. Film speed dials
- 7-8. What term refers to the length of time film is exposed to light through the lens of a camera?
1. Aperture
 2. Film speed
 3. Shutter speed
 4. Camera speed
- 7-9. What type of camera automatically sets the aperture once you select the shutter speed?
1. Shutter priority
 2. Aperture priority
 3. Fully automatic
 4. Manual
- 7-10. Film sensitivity is referred to by what term?
1. PMS
 2. ISO
 3. MIL
 4. SPD
- 7-11. What copy camera has the film plane built into the wall?
1. Horizontal process cameras
 2. Darkroom cameras
 3. Gallery cameras
 4. Vertical process cameras
- 7-12. Using a process camera, how can you make focusing images on the ground glass of a focal plane easier?
1. Place extra lights around the copyboard
 2. Leave the room lights off during focusing
 3. Leave the room lights on during focusing
 4. Open the aperture wide open
- 7-13. What device allows critical focus for maximum image resolution?
1. Microscope
 2. Densitometer
 3. Durometer
 4. Loup
- 7-14. How should you place the film on the film plane?
1. Emulsion against the film back
 2. Emulsion toward the light source
 3. Emulsion against the vacuum plate
 4. Emulsion toward the photographer

- 7-15. What is the term for a weak acetic acid that neutralizes the process during film development?
1. Developer
 2. Stop bath
 3. Fixer
 4. Wash
- 7-16. What tray of chemicals is used to remove light sensitive crystals from paper or film during the development process?
1. Developer
 2. Stop bath
 3. Fixer
 4. Wash
- 7-17. During processing, brownness or streaked images result when film or paper is kept for an insufficient amount of time in which of the following processing trays?
1. Developer
 2. Stop bath
 3. Fixer
 4. Wash
- 7-18. What is an ideal temperature for photograph chemistry in a four tray development process?
1. 70 degrees
 2. 76 degrees
 3. 80 degrees
 4. 86 degrees
- 7-19. For photograph development to occur in less than ideal conditions, temperature variation between developing trays should not exceed what number of degrees?
1. 5
 2. 2
 3. 3
 4. 4
- 7-20. What condition causes reticulation?
1. Warm developing temperatures
 2. Cool developing temperatures
 3. Extreme temperature variations
 4. Rapid development procedures
- 7-21. Why should you NOT use your hands to move film or paper from one developing tray to the next?
1. To prevent raising the tray-temperature only
 2. To prevent tray contamination only
 3. To prevent raising the tray temperature and tray contamination
 4. To prevent using tongs when they are not necessary
- 7-22. Image development occurs at what stage of automatic processing?
1. Activation
 2. Stabilization
 3. Squeegeeing
 4. Rinsing
- 7-23. When shooting images with a copy camera, how can you minimize camera movement?
1. Press the shutter release slowly
 2. Stabilize the camera on a rubber pad
 3. Attach a cable release
 4. Use fast film
- 7-24. Electronic cameras use what system to record images?
1. Exposure, development, and printing
 2. Capture, enhancement, and display
 3. Exposure, development, and display
 4. Capture, development, and enhancement
- 7-25. Electronic cameras record images in what format?
1. Latent images
 2. Magnetic impulses
 3. Binary luminance
 4. Chrominance
- 7-26. Using an electronic still-video camera, to what mode should you set the camera for maximum image resolution?
1. Field
 2. Frame
 3. Digital
 4. CCD

- 7-27. When using an electronic still-video camera, what total number of floppy disks are required to record 37 images at the highest possible resolution in the frame mode?
1. 1
 2. 2
 3. 3
 4. 4
- 7-28. In a rangefinder camera, what term describes the offset position of the two lenses?
1. Range
 2. Parallax
 3. Paradigm
 4. Parallelism
- 7-29. SLR cameras have pentaprisms which automatically correct image offset.
1. True
 2. False
- 7-30. You should set the film speed dial to correspond to what photographic variable?
1. Aperture
 2. Shutter speed
 3. Film sensitivity
 4. Focus distance
- 7-31. Steel spring blades typify what type of shutter control?
1. Leaf shutters
 2. Focal plane shutters
 3. Aperture priority shutters
 4. Shutter speed priority shutters
- 7-32. Most 35mm cameras have what type of shutter?
1. Leaf
 2. Focal plane
 3. Aperture priority
 4. Shutter speed priority
- 7-33. What is the consequence of failing to depress the film rewind button on the bottom of a camera body before attempting to rewind film?
1. The film will not rewind.
 2. The film will tear through the sprocket holes
 3. The camera will eject the film
 4. The camera will expose the film
- 7-34. The amount of light from what source is measured by through-the-lens metering?
1. Entering the lens
 2. Falling on the subject
 3. Emanating from the sun
 4. Falling on the surroundings
- 7-35. What can you do to exert complete creative control over SLR cameras?
1. Use the camera in the automatic mode
 2. Use the camera in the semi-automatic mode
 3. Use a superfast film speed
 4. Use the manual override
- 7-36. What action can you take to preview a meter reading without tripping the shutter?
1. Depress the shutter release
 2. Stop down the lens
 3. Partially depress the shutter release
 4. Trip the cable release
- 7-37. What setting maintains the camera shutter open for as long as the shutter release is depressed?
1. 1
 2. B
 3. T
 4. 1/4
- 7-38. What setting maintains the camera shutter in an open position indefinitely?
1. 1
 2. T
 3. B
 4. 1/4
- 7-39. For hand-held photography, what shutter speed is the longest recommended exposure?
1. 1/4
 2. 1/8
 3. 1/15
 4. 1/30
- 7-40. For optimum exposure during flash photography, what shutter speed is recommended?
1. 1/30
 2. 1/60
 3. 1/125
 4. 1/250

- 7-41. To correct images that have blurry backgrounds but focused central areas, what action should you take?
1. Refocus
 2. Stabilize subject
 3. Use a slower shutter speed
 4. Use a faster shutter speed
- 7-42. On moderately sunny days, to stop the action of saluting subjects twelve feet away positioned diagonally toward the camera, what shutter speed is recommended?
1. 1/500
 2. 1/250
 3. 1/125
 4. 1/60
- 7-43. For the best results when photographing a plane in flight on a sunny afternoon, which of the following shutter speeds is recommended?
1. 1/250
 2. 1/125
 3. 1/60
 4. 1/30
- 7-44. An aperture is also referred to by what term?
1. Diaphragm
 2. Luminier
 3. f/stop
 4. Ring
- 7-45. What term describes the diameter of the lens opening that controls the amount of light striking the film?
1. Diaphragm
 2. Luminier
 3. Aperture
 4. Leaf
- 7-46. The brighter the light the smaller the recommended diaphragm opening.
1. True
 2. False
- 7-47. Which of the following f/stop adjustments results in twice the amount of light striking the film?
1. f/2 to f/16
 2. f/5.6 to f/8
 3. f/5.6 to f/4
 4. f/16 to f/11
- 7-48. Which of the following f/stop adjustments reduces the amount of light striking the film by half?
1. f/16 to f/5.6
 2. f/5.6 to f/2.8
 3. f/2.8 to f/4
 4. f/8 to f/16
- 7-49. On a standard lens with f/stops ranging from f/1.2 to f/22, at what f/stop is the lens considered wide open?
1. f/1.2
 2. f/4
 3. f/5.6
 4. f/22
- 7-50. On a 50mm macro lens with f/stops ranging from f/2.8 to f/16, at what f/stop is the most light admitted?
1. f/2.8
 2. f/5.6
 3. f/8
 4. f/16
- 7-51. While aboard ship photographing daylight scenes with a 35mm camera and 400 ISO film, your TTL meter fails and your hand-held meter falls overboard. What action(s) should you take to continue shooting with minimum interruption?
1. Send down below for another hand-held meter
 2. Delay all activity until another camera arrives
 3. Quickly change camera batteries
 4. Set the camera to f/16 and the shutter speed close to 400
- 7-52. What is the definition of the focal length of a lens?
1. How far the lens can focus
 2. How wide a lens can focus
 3. The distance between the lens plane and the focal plane
 4. The distance between the lens optical center and the focal plane
- 7-53. Which of the following lenses is considered a long-range lens?
1. 28mm
 2. 35mm
 3. 50mm
 4. 58mm

- 7-54. Which of the following lens is recommended for portraiture?
1. 35mm-85mm macro zoom
 2. 85mm-105mm zoom
 3. 50mm standard
 4. 50mm macro
- 7-55. Which of the following short-range lenses is also called a fisheye lens?
1. 17mm
 2. 24mm
 3. 28mm
 4. 35mm
- 7-56. Which of the following lenses is recommended for shooting a panoramic view of the side of a ship?
1. 50mm
 2. 24mm
 3. 105mm
 4. 300mm
- 7-57. What lens results in the least distortion?
1. 17mm
 2. 50mm
 3. 200mm
 4. 300mm
- 7-58. You are asked to photographically document damages from a crane accident in an unstable and potentially hazardous environment. What lens should you choose to remain a safe distance from the danger while still allowing you to close in on the subject?
1. 24mm
 2. 50mm standard
 3. 50mm macro
 4. 100mm macro
- 7-59. What is the lens speed of a 50mm macro lens with f/stops ranging from f/3.4 to f/16?
1. f/3.4
 2. f/5.6
 3. f/8
 4. f/16
- 7-60. What action should you take to increase depth of field for any given camera?
1. Change lenses
 2. Open up the aperture
 3. Stop down the aperture
 4. Use a faster rated film
- 7-61. Latent images are formed when what part of black-and-white photographic film reacts to light?
1. Base
 2. Overcoating
 3. Silver halides
 4. Antihalation backing
- 7-62. Which of the following film types indicates a color reversal film?
1. Kodalith
 2. Vericolor
 3. Ektachrome
 4. Panatomic-x
- 7-63. Which of the following film-types indicates a color negative film?
1. Kodalith
 2. Vericolor
 3. Ektachrome
 4. Panatomic-x
- 7-64. In total darkness, which of the following procedures can you use to identify the emulsion side of sheet film?
1. Rub your fingers across both surfaces to feel for roughness
 2. Place the edge of the film between your lips to find the side that sticks
 3. Scratch the film with a fingernail
 4. Smell the film for sweetness on the emulsion side
- 7-65. What term refers to the sensitivity to light of a film emulsion?
1. Latency
 2. Film sensitivity
 3. Film speed
 4. Film range
- 7-66. Which of the following situations requires a fast film?
1. An outdoor personnel inspection
 2. Macro work on a defective shore power cable
 3. Copy work under tungsten carbide lamps
 4. Dense viewgraphs backlit on a copyboard
- 7-67. In graphics photography, what film classification is used most often?
1. Monochromatic
 2. Ektachromatic
 3. Panchromatic
 4. Infrared

- 7-68. What type of photography primarily uses orthochromatic film?
1. Copy work
 2. Pictorial
 3. X-ray
 4. Color
- 7-69. What black-and-white film is used most often in portraiture?
1. Monochromatic
 2. Orthochromatic
 3. Panchromatic
 4. Infrared
- 7-70. Infrared films do NOT require any special considerations or techniques for critical focusing.
1. True
 2. False
- 7-71. In printed images, the portions of silver halides least effected by exposure to light appear as what factor(s)?
1. Highlights
 2. Midtones
 3. Foreground
 4. Shadows
- 7-72. Exposure latitude is described by which of the following statements?
1. The ability of the film to record a range of scene brightnesses
 2. The amount of variance in exposure setting the film allows while still producing acceptable contrast
 3. The amount of metallic silver deposited in any one portion of the negative
 4. The difference in density between areas in a negative
- 7-73. A photographic print that appears soft and slightly out of focus has what attribute?
1. Graininess
 2. Reticulation
 3. Poor resolution
 4. Short depth of field
- 7-74. Color prints made from film that has past the point of freshness have what appearance?
1. Yellow edges
 2. Extreme reticulation
 3. Increased graininess
 4. Shifted color balance
- 7-75. You should remove 35mm film from cold storage what total number of minutes before use?
1. 30 minutes
 2. 45 minutes
 3. 60 minutes
 4. 90 minutes

ASSIGNMENT 8

Textbook Assignment: "Photography," chapter 7, pages 7-41 through 7-46; and "Computer Generation," chapter 8, pages 8-1 through 8-56.

- 8-1. During the printing process, manipulating the exposure to give more light to a selected area is known by what term?
1. Selective exposure
 2. Spot color
 3. Dodging
 4. Burning in
- 8-2. In a darkroom, most photographic print papers should be handled under what lighting conditions or fixture?
1. Normal room light
 2. Light less than 25 watts
 3. Fluorescent light
 4. Safelight
- 8-3. What type of photographic paper surface would be best suited for use in intelligence briefings?
1. Color matte prints
 2. Linen prints
 3. Black-and-white glossy prints
 4. Black-and-white matte prints
- 8-4. How long before use should you remove photographic papers from cold storage?
1. 1 hour
 2. 2 hours
 3. 5 hours
 4. Overnight
- 8-5. What is a major disadvantage to darkroom cropping?
1. Paper waste
 2. Decreased resolution
 3. Critical focusing
 4. Enlarging the projected image beyond enlarger limits
- 8-6. Which of the following descriptions accurately identifies software?
1. CDROM
 2. Floppy disk
 3. Set of instructions
 4. Printed instructions
- 8-7. What type of software manages the computer system?
1. RAM
 2. WORM
 3. Application
 4. Operating system
- 8-8. Which of the following features is NOT part of pagination?
1. Page numbering
 2. Setting margins
 3. Selecting text attributes
 4. Footnotes
- 8-9. What results when data entered without defined document parameters is paginated?
1. The data falls into place
 2. The data uncontrollably scatters
 3. The document requires reformatting
 4. The format settings must be defined for each paragraph
- 8-10. Allowing unused codes to remain in a document presents problems in what phase of document creation?
1. Data entry
 2. Saving
 3. Editing
 4. Printing
- 8-11. To automatically return the cursor to the left hand margin when entering a long line of text, what, if anything, must you do?
1. Depress enter
 2. Enter a hard return
 3. Tab over
 4. Nothing
- 8-12. You can avoid the unnecessary labor of recreating documents after a hard drive crash by taking what action at the end of the work day?
1. Exiting the computer systematically
 2. Labeling disks when created
 3. Using working copy disks
 4. Backing up data files
- 8-13. After encountering rough seas during a foul weather sortie, your computer monitor exhibits erratic pixel pigmentation. What should be your first action?
1. Call the ADPSSO for help
 2. Call the ETs for repair
 3. Check the connections of the graphics array card
 4. Check the plug in the central processing unit

- 8-14. Electronic data containing classified or sensitive material belongs to what category?
1. Level I
 2. Level II
 3. Level III
 4. Level IV
- 8-15. FOUO electronic data belongs to what category?
1. Level I
 2. Level II
 3. Level III
 4. Level IV
- 8-16. You do not have a security clearance but you use a shop computer known to handle classified material. What security operating mode, if any, is in effect on the computer system you use?
1. System high
 2. Dedicated
 3. Controlled
 4. None
- 8-17. You are stationed on a tender. What circumstance requires finished media disks?
1. A welcome aboard brochure for a unit alongside
 2. A picnic flyer
 3. An unfinished engineering log
 4. A departmental watchbill
- 8-18. How should you label a disk containing Top Secret material?
1. Top Secret only
 2. Top Secret and serial number only
 3. Top Secret, serial number, and master ID number list
 4. Top Secret, Level I and serial number
- 8-19. Irregular computer behavior could result from which of the following causes?
1. Loose IC chips
 2. Loose plug-ins
 3. Program quirks
 4. Viruses
- 8-20. You can protect floppy disks from contracting viruses by taking which of the following actions?
1. Placing disks in paper envelopes
 2. Using the write-protect tab
 3. Transporting disks only in polystyrene
 4. Using back-up disks
- 8-21. The appearance of a trailing arrowhead indicates the use of what input device?
1. A keyboard
 2. A mouse
 3. A light pen
 4. A stylus
- 8-22. When working with computer graphics, the cursor will normally appear in what form on the monitor screen?
1. As a blinking bar
 2. As an arrowhead
 3. As cross hairs
 4. As an hourglass
- 8-23. An hourglass on the computer monitor screen indicates what activity?
1. The position of the cursor
 2. The use of a graphics option
 3. The accessing of a program or function
 4. The time allotted to complete a function
- 8-24. What computer icon informs you that the function you have chosen is not accessible?
1. A hand
 2. A prohibiting circle
 3. A prohibiting arrow
 4. A directional arrow
- 8-25. Consolidating keystrokes and accessing functions through the use of graphic images is the purpose of which of the following interfaces?
1. VGA
 2. SVGA
 3. GUI
 4. CPU
- 8-26. What is the term for the enclosed areas on computer screens that display information and options?
1. Title bars
 2. Windows
 3. Icons
 4. Doors
- 8-27. What term refers to common features lists that appear on the computer screen?
1. Menus
 2. Icons
 3. Picks
 4. Windows

- 8-28. To access the list of options available in each feature of a menu, you should take what action?
1. Press the enter key
 2. Press the LIST key
 3. Click the mouse on the feature
 4. Click the mouse on LIST
- 8-29. Options inside a dialogue box are known by what name?
1. Windows
 2. Menus
 3. Pull-down lists
 4. Drop-down lists
- 8-30. Features NOT available for use or that are inactive appear on the computer screen in what form or color?
1. Dense black
 2. Greyed-out
 3. Highlighted
 4. White
- 8-31. On pull-down menus, what do keystroke notations to the right of the options indicate?
1. Additional information required
 2. Binary coding
 3. Additional keystrokes required
 4. Keystrokes required to access the desired function
- 8-32. A checkmark next to a ruler option provides what information?
1. The option is unavailable
 2. The option is activated
 3. The option requires extra keystrokes
 4. The option is deactivated
- 8-33. The HELP feature allows you to access and print instructions.
1. True
 2. False
- 8-34. Software options are displayed on computer screens through which of the following means?
1. Windows
 2. Toolbars
 3. Pull-down lists
 4. Drop-down lists
- 8-35. When fitting a large amount of information into a set space, what toolbar option is most helpful?
1. Justification
 2. Line spacing
 3. Symbolology
 4. Zoom
- 8-36. When bolding, underlining, or italicizing text, what action should you take to limit the amount of text affected?
1. Use select and deselect options
 2. Place the text in parentheses
 3. Place the text in brackets
 4. Change the document format
- 8-37. You can most easily replace material previously deleted by performing what action?
1. Select CUT
 2. Select REDO
 3. Select COPY
 4. Retype the material
- 8-38. You may access material collected on the electronic clip board by using what command?
1. CUT
 2. REDO
 3. COPY
 4. PASTE
- 8-39. Which of the following two words would the SPELL CHECK command NOT recognize as improperly used?
1. The and teh
 2. Their and thier
 3. Way and whey
 4. Care and crae
- 8-40. What filing classification stores specific or large file data?
1. Root directory
 2. Parent directory
 3. Directories
 4. Subdirectories
- 8-41. Excluding the three-character extension, a file name may have what maximum number of characters?
1. 6
 2. 7
 3. 8
 4. 9
- 8-42. The three-character extension on file names normally indicates what factor?
1. Type of document only
 2. Format only
 3. Type or format of the document
 4. Originator of the file

- 8-43. If you want to access files without changing them, what option should you select?
1. LOOK
 2. OPEN
 3. MOVE
 4. RETRIEVE
- 8-44. What is the result, if anything, of selecting the PRINT command while viewing the root directory?
1. A printout of the root directory
 2. A printout of every item in the root directory
 3. A printout of the file the cursor was on
 4. Nothing
- 8-45. In what file format is pixelation most likely to occur?
1. Binary matrix
 2. Binary digit
 3. Vector
 4. Raster
- 8-46. Why is editing in vector-based graphics easier than in raster-based graphics formats?
1. Layering capability
 2. Matrix construction
 3. Automatic recalculation
 4. Color sensitivity
- 8-47. Why do raster-based images reproduce better than vector-based images?
1. Decreased dpi
 2. Increased dpi
 3. Decreased lpi
 4. Increased lpi
- 8-48. As long as there are no graphics, which of the following file formats is compatible with any software program?
1. ASCII
 2. EPSF
 3. TIFF
 4. RIFF
- 8-49. Which of the following formats is a vector-based format best used for quality reproduction?
1. ASCII
 2. EPSF
 3. TIFF
 4. RIFF
- 8-50. Which of the following formats is an image compression format designed for use on a LAN or WAN network?
1. TIFF
 2. RIFF
 3. GIFF
 4. JPEG
- 8-51. Which of the following programs is a vector-based, image creation software program?
1. Drawing
 2. Painting
 3. Drafting
 4. Photographic
- 8-52. Which of the following types of software programs allows photographic images to be altered?
1. Image creation
 2. Image editing
 3. Image presentation
 4. Image distortion
- 8-53. What graphics software program provides preformatted solutions to graphic images?
1. Image creation
 2. Image editing
 3. Image presentation
 4. Image manipulation
- 8-54. What can you do to simplify color separation artwork in computer-generated art?
1. Work in multiple layers
 2. Combine layers containing small design elements
 3. Work in the paint environment
 4. Work in one layer formats
- 8-55. A marquee icon represents what type of computer tool?
1. Movement
 2. Isolating
 3. Auto-trace
 4. Shape
- 8-56. When working on an image is difficult, what should you do to simplify the process?
1. Move the image out of the main body
 2. Ungroup or isolate the area
 3. Group elements to another layer that is easier to work in
 4. Import the graphic into a simpler graphic program

- 8-57. You should use rendering tools for what purpose?
1. To save
 2. To edit
 3. To delete
 4. To airbrush
- 8-58. What rendering tool allows the mixing and matching of colors already on the illustration?
1. Bucket
 2. Blend
 3. Eyedropper
 4. Airbrush
- 8-59. Combining images to form one composition is best accomplished by which of the following blending tools?
1. Feather
 2. Clone
 3. Grabber
 4. Smudge
- 8-60. What stylizing filter allows the altering of images to the point of extreme contrast in monochromatic colors?
1. Solarize
 2. Posterize
 3. Faceting
 4. Crystallizing
- 8-61. What stylizing filter should you use to create color separations in image-editing software?
1. Thresholding
 2. Posterize
 3. Faceting
 4. Mosaic
- 8-62. To imply movement in computer-generated images, you should use what stylizing filter?
1. Blur
 2. Sharpen
 3. Fragment
 4. Pointillist
- 8-63. Computer cathode-ray tube monitors are usually formatted for what type of color?
1. RGB
 2. CYMK
 3. Pantone
 4. Spot color
- 8-64. When preparing color computer-generated master art for reproduction, what color format should you select?
1. RGB
 2. CYMK
 3. Pantone
 4. Spot color
- 8-65. What color format should be used for artwork intended for spot color only?
1. RGB
 2. CYMK
 3. Pantone
 4. Bourgeess color
- 8-66. What special effects filter should you use to imply movement in color computer art?
1. Smear
 2. Effects
 3. Brushes
 4. Cycling
- 8-67. To increase the resolution in printed work, what can you do during creation of the computer-generated images?
1. Increase the dpi to twice the printed lpi
 2. Decrease the dpi to half the printed lpi
 3. Create the masters in monochrome
 4. Save drawings in various stages
- 8-68. Initial typographical page definitions are set by what DTP element?
1. Tags
 2. Frames
 3. Windows
 4. Style sheets
- 8-69. Box outlines that define page size are known by what term?
1. Tags
 2. Frames
 3. Windows
 4. Style sheets
- 8-70. What information is inappropriate for inclusion on command-generated web pages?
1. CMC's commnad brief
 2. Ombudsman information
 3. Prospective deployments
 4. Personnel roster with home phone numbers

8-71. What element of worldwide internet transmission keeps individuals focused inside the command web page?

1. WWW
2. Internal links
3. External links
4. Hypertext markup language

8-72. Frequently asked questions (FAQs) may be appended to a command web page as an internal link.

1. True
2. False

8-73. What domain suffix identifies a military website?

1. .com
2. .gov
3. .mil
4. .org

8-74. For what reason should you use other browsers to review websites you have created?

1. To make sure distortion is minimal
2. To make the web page available in different formats
3. To modify HTML code for regional addresses.
4. To be sure the website is not offensive to regional addresses

