



**NONRESIDENT  
TRAINING  
COURSE**



May 2001

---

# Postal Clerk

**NAVEDTRA 14317**

Although the words “he,” “him,” and “his” are used sparingly in this course to enhance communication, they are not intended to be gender driven or to affront or discriminate against anyone.

## PREFACE

By enrolling in this self-study course, you have demonstrated a desire to improve yourself and the Navy. Remember, however, this self-study course is only one part of the total Navy training program. Practical experience, schools, selected reading, and your desire to succeed are also necessary to successfully round out a fully meaningful training program.

**COURSE OVERVIEW:** In completing this NRTC, you will demonstrate a knowledge of the subject matter by correctly answering questions on the following topics: the military postal service; designations and terminations; mail packaging and acceptance; domestic mail; special services; international mail; registered mail; postal finance; mail handling and transportation; claims and inquiries; directory mail; postal equipment and supplies; official mail; and post office procedures.

**THE COURSE:** This self-study course is organized into subject matter areas, each containing learning objectives to help you determine what you should learn along with text and illustrations to help you understand the information. The subject matter reflects day-to-day requirements and experiences of personnel in the rating or skill area. It also reflects guidance provided by Enlisted Community Managers (ECMs) and other senior personnel, technical references, instructions, etc., and either the occupational or naval standards, which are listed in the *Manual of Navy Enlisted Manpower Personnel Classifications and Occupational Standards*, NAVPERS 18068.

**THE QUESTIONS:** The questions that appear in this course are designed to help you understand the material in the text.

**VALUE:** In completing this course, you will improve your military and professional knowledge. Importantly, it can also help you study for the Navy-wide advancement in rate examination. If you are studying and discover a reference in the text to another publication for further information, look it up.

*2001 Edition Prepared by  
PCC (SW) David W. Duncan*

External review provided by:

PCCS (AW/SW) Dale J. Pinchart  
Navy Postal Policies Division at Commander, Naval Supply Systems Command

Published by  
NAVAL EDUCATION AND TRAINING  
PROFESSIONAL DEVELOPMENT  
AND TECHNOLOGY CENTER

**NAVSUP Logistics Tracking Number  
0504-LP-100-2193**

## **Sailor's Creed**

“I am a United States Sailor.

I will support and defend the Constitution of the United States of America and I will obey the orders of those appointed over me.

I represent the fighting spirit of the Navy and those who have gone before me to defend freedom and democracy around the world.

I proudly serve my country's Navy combat team with honor, courage and commitment.

I am committed to excellence and the fair treatment of all.”

# TABLE OF CONTENTS

<b>CHAPTER</b>	<b>PAGE</b>
1 The Military Postal Service .....	1-1
2 Designations and Terminations .....	2-1
3 Mail Packaging and Acceptance.....	3-1
4 Domestic Mail .....	4-1
5 Special Services .....	5-1
6 International Mail .....	6-1
7 Registered Mail .....	7-1
8 Postal Finance.....	8-1
9 Mail Handling and Transportation .....	9-1
10 Claims and Inquiries.....	10-1
11 Directory Mail.....	11-1
12 Postal Equipment and Supplies.....	12-1
13 Official Mail.....	13-1
14 Post Office Procedures.....	14-1
 <b>APPENDIX</b>	
I. Answers to Review Questions.....	AI-1
II. Postal Terms, Abbreviations, and Acronyms.....	AI-2
III. Example of Standard Operating Procedures and Postal Operating Plan.....	AI-3
IV. Definitions of Postal Activity Reporting System Data Elements.....	AI-4
V. References Used to Develop This NRTC.....	AI-5
 <b>INDEX</b> .....	 INDEX-1



# INSTRUCTIONS FOR TAKING THE COURSE

## ASSIGNMENTS

The text pages that you are to study are listed at the beginning of each assignment. Study these pages carefully before attempting to answer the questions. Pay close attention to tables and illustrations and read the learning objectives. The learning objectives state what you should be able to do after studying the material. Answering the questions correctly helps you accomplish the objectives.

## SELECTING YOUR ANSWERS

Read each question carefully, then select the BEST answer. You may refer freely to the text. The answers must be the result of your own work and decisions. You are prohibited from referring to or copying the answers of others and from giving answers to anyone else taking the course.

## SUBMITTING YOUR ASSIGNMENTS

To have your assignments graded, you must be enrolled in the course with the Nonresident Training Course Administration Branch at the Naval Education and Training Professional Development and Technology Center (NETPDTC). Following enrollment, there are two ways of having your assignments graded: (1) use the Internet to submit your assignments as you complete them, or (2) send all the assignments at one time by mail to NETPDTC.

**Grading on the Internet:** Advantages to Internet grading are:

- you may submit your answers as soon as you complete an assignment, and
- you get your results faster; usually by the next working day (approximately 24 hours).

In addition to receiving grade results for each assignment, you will receive course completion confirmation once you have completed all the

assignments. To submit your assignment answers via the Internet, go to:

**<http://courses.cnet.navy.mil>**

**Grading by Mail:** When you submit answer sheets by mail, send all of your assignments at one time. Do NOT submit individual answer sheets for grading. Mail all of your assignments in an envelope, which you either provide yourself or obtain from your nearest Educational Services Officer (ESO). Submit answer sheets to:

COMMANDING OFFICER  
NETPDTC N331  
6490 SAUFLEY FIELD ROAD  
PENSACOLA FL 32559-5000

**Answer Sheets:** All courses include one “scannable” answer sheet for each assignment. These answer sheets are preprinted with your SSN, name, assignment number, and course number. Explanations for completing the answer sheets are on the answer sheet.

**Do not use answer sheet reproductions:** Use only the original answer sheets that we provide—reproductions will not work with our scanning equipment and cannot be processed.

Follow the instructions for marking your answers on the answer sheet. Be sure that blocks 1, 2, and 3 are filled in correctly. This information is necessary for your course to be properly processed and for you to receive credit for your work.

## COMPLETION TIME

Courses must be completed within 12 months from the date of enrollment. This includes time required to resubmit failed assignments.

## **PASS/FAIL ASSIGNMENT PROCEDURES**

If your overall course score is 3.2 or higher, you will pass the course and will not be required to resubmit assignments. Once your assignments have been graded you will receive course completion confirmation.

If you receive less than a 3.2 on any assignment and your overall course score is below 3.2, you will be given the opportunity to resubmit failed assignments. **You may resubmit failed assignments only once.** Internet students will receive notification when they have failed an assignment--they may then resubmit failed assignments on the web site. Internet students may view and print results for failed assignments from the web site. Students who submit by mail will receive a failing result letter and a new answer sheet for resubmission of each failed assignment.

## **COMPLETION CONFIRMATION**

After successfully completing this course, you will receive a letter of completion.

## **ERRATA**

Errata are used to correct minor errors or delete obsolete information in a course. Errata may also be used to provide instructions to the student. If a course has an errata, it will be included as the first page(s) after the front cover. Errata for all courses can be accessed and viewed/downloaded at:

<http://www.advancement.cnet.navy.mil>

## **STUDENT FEEDBACK QUESTIONS**

We value your suggestions, questions, and criticisms on our courses. If you would like to communicate with us regarding this course, we encourage you, if possible, to use e-mail. If you write or fax, please use a copy of the Student Comment form that follows this page.

## **For subject matter questions:**

E-mail: n313.products@cnet.navy.mil  
Phone: Comm: (850) 452-1001, Ext. 2167  
DSN: 922-1001, Ext. 2167  
FAX: (850) 452-1370  
(Do not fax answer sheets.)  
Address: COMMANDING OFFICER  
NETPDTC N313  
6490 SAUFLEY FIELD ROAD  
PENSACOLA FL 32509-5237

## **For enrollment, shipping, grading, or completion letter questions**

E-mail: fleetservices@cnet.navy.mil  
Phone: Toll Free: 877-264-8583  
Comm: (850) 452-1511/1181/1859  
DSN: 922-1511/1181/1859  
FAX: (850) 452-1370  
(Do not fax answer sheets.)  
Address: COMMANDING OFFICER  
NETPDTC N331  
6490 SAUFLEY FIELD ROAD  
PENSACOLA FL 32559-5000

## **NAVAL RESERVE RETIREMENT CREDIT**

If you are a member of the Naval Reserve, you may earn retirement points for successfully completing this course, if authorized under current directives governing retirement of Naval Reserve personnel. For Naval Reserve retirement, this course is evaluated at 15 points. These points will be credited to you upon your satisfactory completion of each unit as shown below:

Unit 1 – 12 points – Assignments 1 through 8

Unit 2 – 3 points – Assignments 9 through 10

(Refer to *Administrative Procedures for Naval Reservists on Inactive Duty*, BUPERSINST 1001.39, for more information about retirement points.)



## Student Comments

**Course Title:** Postal Clerk

**NAVEDTRA:** 14317 **Date:** \_\_\_\_\_

**We need some information about you:**

Rate/Rank and Name: \_\_\_\_\_ SSN: \_\_\_\_\_ Command/Unit \_\_\_\_\_

Street Address: \_\_\_\_\_ City: \_\_\_\_\_ State/FPO: \_\_\_\_\_ Zip \_\_\_\_\_

**Your comments, suggestions, etc.:**

<p><b>Privacy Act Statement:</b> Under authority of Title 5, USC 301, information regarding your military status is requested in processing your comments and in preparing a reply. This information will not be divulged without written authorization to anyone other than those within DOD for official use in determining performance.</p>
--

NETPDTC 1550/41 (Rev 4-00)



## CREDITS

The illustrations listed below are included in this edition of *Postal Clerk* through the courtesy of the U.S. Postal Service. Permission to use these illustrations is gratefully acknowledged. Permission to reproduce the illustrations in this publication must be obtained from the source.

<u>Source</u>	<u>Figures</u>
U.S. Postal Service 2000	3-6, 3-7



## CHAPTER 1

# THE MILITARY POSTAL SERVICE

The purpose of this chapter is to give you a basic knowledge of the Military Postal Service (MPS), its mission and functions, service commitments, postal facilities, postal personnel, training, sources of information, and categories of personnel entitled to use MPS facilities.

### MISSION AND FUNCTIONS

---

**Learning Objective:** *Recall the mission and functions of the Military Postal Service (MPS) with a brief explanation on the nature of the MPS, the USPS/DOD postal agreement, and the types of mail and postal services.*

---

The mission of the Military Postal Service (MPS) is to provide service to the Department of Defense (DOD) agencies in support of DOD missions. The DOD operates military post offices (MPOs) in areas where the U.S. Postal Service (USPS) does not operate or in other places where the military situation requires. It also provides postal service at Navy and Marine Corps installations where the USPS has primary responsibility. The ultimate goal of the MPS is to provide a level of service equal to that provided by the USPS to the civilian population of the United States. Another goal is to ensure that an overlap or duplication of MPS functions between two military organizations in the same serving area does not occur. The Military Postal Service is an extension of the USPS beyond the boundaries of U.S. sovereignty and is obligated to provide prompt, reliable, and efficient postal service for all DOD personnel overseas where USPS is not available.

*USPS Publication 38* is the governing directive on the Postal Agreement between the United States Postal Service and the Department of Defense. This publication outlines both DOD and USPS responsibilities in providing postal services for the Armed Forces. *USPS publication 38-A* is the directive that describes postal services available to military installations in the United States. You do not need to become familiar with these publications, but you should be aware they exist.

### NATURE OF THE MILITARY POSTAL SERVICE

The MPS is an extension of the USPS and operates under an agreement between the DOD and the USPS. On 5 May 1980, a single manager for military postal matters for the DOD was established. The Secretary of the Army was designated as the single manager. This reorganization created the Military Postal Service Agency (MPSA), and the Secretary of the Army named the Adjutant General, U.S. Army, the Executive Director, Military Postal Service Agency. The Executive Director, MPSA, serves as the Department of Defense's single point of contact with the USPS and other government agencies on Military Postal Service policies and operational matters. The MPSA has many responsibilities. The one responsibility that will most directly affect you in the operation of your post office is MPSA's provision of technical support and monitorship for command postal operations of the military services in overseas areas and provision of technical assistance team visits. Basically, this means that the MPSA is responsible for the direction and administration of the Military Postal Service.

The Military Postal Service includes the Army, Air Force, Navy, Marine Corps, and Coast Guard (when operating under the Department of the Navy). As a group, and in cooperation with each other, the military services provide complete postal services for the U.S. Armed Forces wherever they are deployed.

The Military Postal Service operates in accordance with postal laws of the United States, U.S. Postal Service regulations and instructions, and directives issued by the DOD, the MPSA, and the military departments.

The MPSA is composed of a joint staff of Army, Navy, Air Force, and Marine Corps postal personnel, and DOD civilian employees, headquartered in Alexandria, VA.

Each military department is responsible for carrying out the policies and procedures issued by the DOD and the MPSA. Within the Department of the Navy, the Chief of Naval Operations (CNO, N41) is responsible for the postal service within the Navy. The

Chief of Naval Operations has designated that the Commander, Naval Supply Systems Command (NAVSUP, SUP05), located in Mechanicsburg, PA, act as the single point for matters relating to postal policy. Each fleet commander-in-chief is directly responsible for the administration, operation, and monitoring of the Military Postal Service within that portion of the postal service under his/her control. Figure 1-1 shows the Navy's chain of command for postal policy matters and MPSA's chain-of-command for operational matters.

## USPS/DOD POSTAL AGREEMENT

Earlier in this nonresident training manual (NRTC), it was stated that MPOs operate as an extension of the USPS. Since Navy post offices (NPOs) technically are part of the MPS, their operation must follow the current postal agreement between the DOD and the USPS. The following are highlights from this agreement.

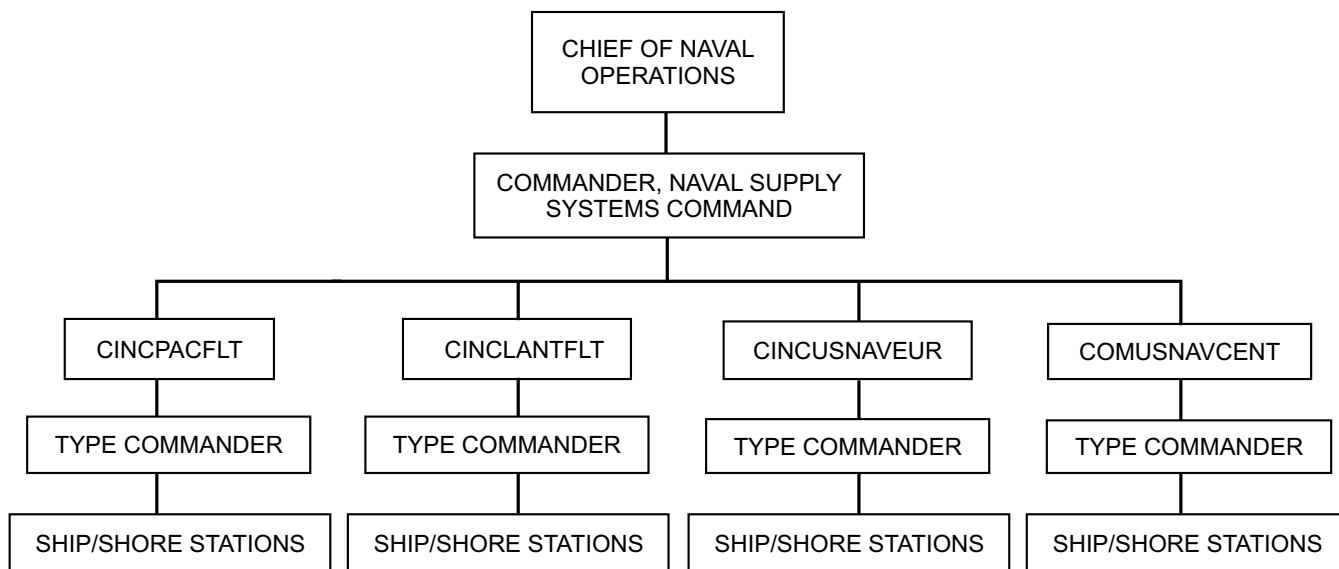

### NAVY POLICY MATTERS

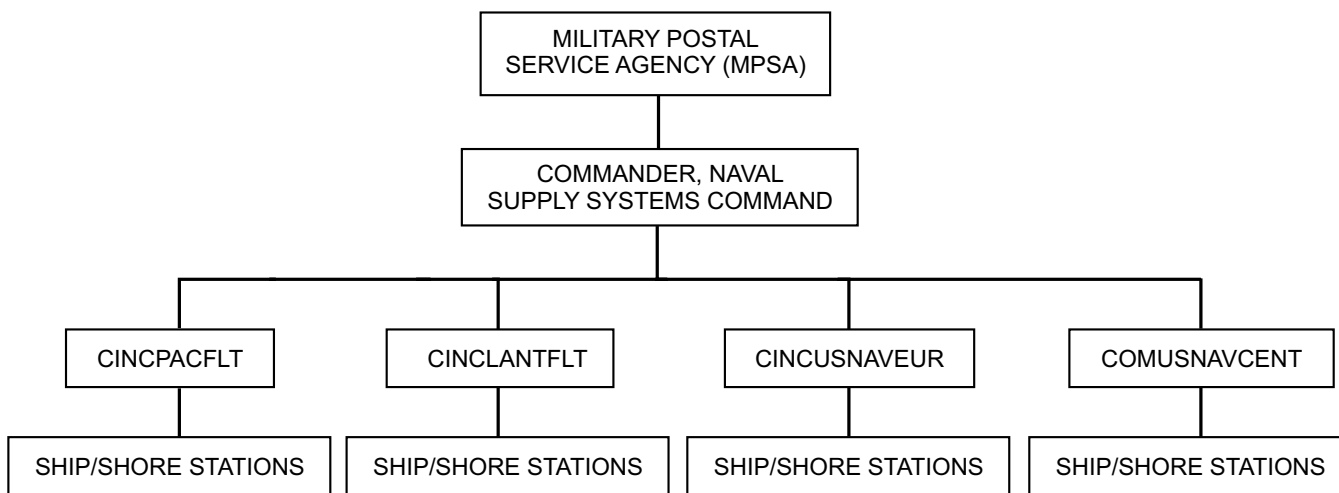

### NAVY OPERATIONAL MATTERS

PCf0101

Figure 1-1.—Chains-of-command for postal policy and postal operational matters.

The DOD agrees to:

- Arrange and pay for military mail transportation from overseas facilities to/from U.S. gateways and between overseas military facilities located within the same geographical area.
- Appoint mail clerks who are qualified to perform postal duties, have been issued uniform identification cards, and have no record of any crime involving theft, moral turpitude, or have not been disciplined for any actions reflecting unfavorably upon their integrity.
- Not accept collect on delivery (C.O.D.) mail for delivery at MPOs.
- Assume financial liability, under military claims procedures, for the loss, damage, theft, wrong delivery, or rifling of accountable mail by a military or civilian mail clerk employed by the DOD.
- Assist the USPS in surveying, inspecting, and auditing military postal facilities.

The USPS agrees to:

- Provide inbound and outbound mail transportation between the postal concentration centers and military or commercial air or surface carriers.
- Provide equipment necessary for the operation of MPOs; to also provide supplies and accountable equipment without charge. Non-accountable equipment is to be furnished on a reimbursable basis.
- Neither accept nor forward to MPOs any C.O.D. mail.
- Relieve custodians of postal effects (COPEs) of responsibility for the amount of the invoice of any shipment of stamps or stamped paper lost in transit as a result of a casualty.
- Furnish office space for related military postal liaison units at USPS facilities centers.

This is just a small amount of the USPS/DOD postal agreement. *USPS Publication 38* contains the entire agreement.

## TYPES OF MAIL AND POSTAL SERVICES

As you will see, the types of mail and postal services provided by a military post office (MPO) are very similar to those provided by a civilian post office.

Because you may have just begun providing postal services, some postal terms in this NRTC may be new to you. Whenever you see a postal term and do not understand its meaning, go to appendix 2, “Postal Terms, Abbreviations and Acronyms,” of this NRTC and study the term’s meaning. By doing this, you will gain an understanding of the postal terms needed to get the most benefit from this manual. For example, chapter 4, “Domestic Mail,” will discuss the types and classes of mail accepted by the military postal facility and chapter 5, “Special Services,” will discuss special postal services such as insured mail. You will need to understand all of the terms to understand the discussion.

*Q1-1. What is the basic mission of the Military Postal Service?*

*Q1-2. What official has been designated as the single manager for postal matters for the Department of Defense?*

*Q1-3. What publication should you consult for an in-depth look at the postal agreement between the Department of Defense and the United States Postal Service?*

Now turn to appendix 1 to check your answers.

## SERVICE COMMITMENTS

---

**Learning Objective:** *Recall the service commitments of the MPS regarding customer service and customer information.*

---

The goal of the Military Postal Service is to provide, as a minimum, a level of service equal to that provided by the USPS to the civilian sector in the United States.

All the classes of mail handled by a civil post office are also handled by military post offices. This includes both official and personal mail. Official mail is a vital link in a command’s chain of communications, and the manner in which you process personal mail affects morale. Therefore, it is important that outgoing mail (official and personal) is dispatched as quickly as possible, and incoming mail delivered promptly to departments, commands, and individuals. As you can see, you are placed in a key position in a major communications operation. Other services you will provide include acceptance of articles for mailing, the selling and cashing of money orders, and the selling of stamps and postal stationery items. Also, various

special mail services such as registry and insurance are available.

One daily question asked by postal patrons that will never go away is, “How long will it take for this letter to get there?”

If you are familiar with the USPS service commitments (ZIP Code mail only), then this question is not as impossible to answer as you may think. Table 1-1 (USPS service commitments) shows the class of mail and the time it normally takes for the USPS to make delivery. These service standards are for continental United States (CONUS) delivery; however, if you are at an overseas MPO, just add on the time it takes for the letter mail dispatch to transit through military control and arrive at the gateway. You may not be able to give an exact delivery day, but you should be very close. The USPS evaluates its service commitments very closely and publishes them in the *National Five-Digit ZIP Code and Post Office Directory* (Publication 65-A).

You can improve service by advising your customers of the following:

- Inform correspondents and publishers of their correct mailing addresses to include delivery receptacle numbers, as applicable.

- Submit change of address cards immediately when a new address is known.
- Notify the responsible mail clerk or mail orderly when departing on leave or temporary duty.
- Report to the postal officer, mail clerk, or mail orderly any instance when inadequate mail service or other mail-related problems are noted.

## CUSTOMER SERVICE

You should strive to give your postal customers the best service possible, not only in the dispatch and delivery of their mail but also in window business transactions. You should consider it a privilege to serve the public and to make an all-out effort to help customers in any way possible. As a window clerk, you should always be courteous, efficient, knowledgeable in your job, and give excellent service day in and day out. As a window clerk, here are some of the guidelines you should follow:

- Provide a neat and clean counter on which to transact business
- Present a well-groomed and neat personal appearance
- Give a friendly greeting that expresses a desire to help

Table 1-1.—USPS Service Commitments.

### UNITED STATES POSTAL SERVICE Service Commitments (ZIP Coded mail only)

Mail Class	Over-night	2nd Day	3rd Day	4th Day	5th Day	6th Day	7th Day	8th Day	9th Day	10th Day	Notes
Express Mail											Directories available at your local post offices.
Priority Mail											Primarily a two-day product.
First-Class Mail											11 ounces or less.
Periodicals											Surface preferential
Standard Mail (B)											See local BMC Manager for Parcel Post Commitments.
Standard Mail (A)											Mail entered at the Destination P&DC has a 2&3 day commitment.

PC10101©

For additional information contact the MANAGER, SERVICE POLICIES AND PROGRAMS, POSTAL HEADQUARTERS, 475 L'ENFANT PLAZA SW, WASHINGTON DC 20260-2806.



- Be knowledgeable, well informed, and interested in helping customers with their postal needs
- Provide prompt, alert, and efficient service to each customer
- Provide competent and correct information on all inquiries
- Give polite referral to another window or individual, when necessary, to provide the service requested
- Give the departing customers a sense of your willingness to help serve their needs
- Refer all disagreements to your supervisor

## CUSTOMER INFORMATION

Military postal clerks should make sure that information used by customers on a day-to-day basis is readily available. An adequate supply of the most current copies of the following items should be on hand or posted for customer use:

- USPS Publication 2, *Packaging for Mailing*
- USPS Publication 65, *National Five-Digit ZIP Code and Post Office Directory*
- USPS Poster 123-L, Postal Rates and Fees
- USPS Poster 39, The Postal Customers Bill of Rights
- USPS Poster 74, Packaging Pointers
- USPS Form 4314-C, Consumer Service Card
- Example of a properly completed change of address card
- Example of a correct mailing address to be used by personnel served
- Hours of operation
- Mail collection/closeout times
- Customs declarations information
- Mailing dangerous materials notice

You need only post or supply those publications, forms, and posters that are commonly used. Some of this information will be included in your standard operating procedures (SOP); see appendix 3.

*Q1-4. What is the standard of service goal of the Military Postal Service?*

*Q1-5. To what USPS publication should you refer when explaining service commitments to a postal customer?*

Now turn to appendix 1 to check your answers.

## POSTAL FACILITIES

---

**Learning Objective:** *Describe the purpose of the various postal facilities and the services provided.*

---

As previously stated, the function of the MPS is to operate military post offices where needed by the military services and in areas where the USPS does not operate. Functions performed by activities that support the MPS and MPS facilities range from acting as a liaison and providing mail routing information to the USPS (for the processing and distribution of mail only) to mail processing, distribution, and postal finance services in support of the units they serve.

## JOINT MILITARY POSTAL ACTIVITIES

The Joint Military Postal Activities (JMPAs) (Atlantic and Pacific), (JMPA-ATL located in New York, NY) and (JMPA-PAC located in San Francisco, CA) act as the single point of contact for the MPSA with the USPS at the designated commercial airport gateways. The JMPAs perform the following critical functions:

- Provide liaison services for DOD components and their major subordinate commands with local and regional post offices, customs officials, and commercial/military transportation officials.
- Provide detailed and timely information to local USPS officials to facilitate processing, routing, and dispatching of MPS mail.
- Collect, assimilate, and report on factors affecting mail movement to and from the CONUS gateways; identify major problem areas and adverse trends; and resolve problems with local and regional USPS officials.

Naval mobile units and overseas activities use the fleet post office (FPO) address assigned to the ship, unit, or activity depending on the gateway location.

**Table 1-2—Joint military postal activities and areas served.**

<b>JMPA</b>	<b>AREAS SERVED</b>
New York, NY	Ships home-ported on the East Coast in the mid-Atlantic and northern states. Overseas activities located in the Atlantic (less the Caribbean and Central America areas), Europe, and Middle East.
Det. Miami, FL	Ships home-ported in southern states, and activities in the Caribbean (less Cuba) and Central America.
BMC Jacksonville, FL	Ships home-ported in southern states, and activities in the Caribbean (less Cuba) and Central America.
San Francisco, CA	Ships home-ported in California and overseas Pacific areas. Shore activities at overseas Pacific areas, Indian Ocean, and Antarctica.
Det. Seattle, WA	Ships home-ported in the greater Puget Sound area receive their mail via the FPO system out of San Francisco. This mail is routed from San Francisco via JMPA Seattle. JMPA Seattle processes FPO/APO airworthy (Priority/SAM/PAL) parcel mail originating in the northern tier of the United States and destined for FPOs/APOs in the Pacific theater.
Det. Hawaii	Handles mail for the Hawaiian Islands, Kwajalein, Guam, and other Polynesian Islands.

The chart in table 1-2 shows the geographical areas and ships served by each JMPA and their elements.

**AIRPORT MAIL FACILITY/CENTER**

An airport mail facility/center (AMF/AMC) is a facility that is manned and operated by the USPS at specific airports located in the continental United States. Mail for all branches of the U.S. Armed Forces that is addressed with an APO/FPO is concentrated at these points for sorting and onward delivery. The mail is dispatched and transported following instructions issued by the JMPAs.

**BULK MAIL CENTERS**

There are 21 bulk mail centers (BMCs) strategically located throughout the United States.

These USPS mail processing centers comprise a nationwide system for the concentration, distribution, and transportation of Periodical, Standard Mail A, and Standard Mail B mail. Postage rates will be further discussed in chapter 4. Of the 21 BMCs we will only be concerned with the ones that serve the three gateways. Table 1-3 shows the gateways and the serving BMCs.

**MILITARY POST OFFICES**

Military post offices (MPOs) are established on ships and at overseas activities and are branches of the USPS. Post offices that are located at shore activities in U.S. territories, possessions, and in the United States may be branches of a local civil post office.

A post office operated by the Navy may also act as a center for the concentration, consolidation, and

**Table 1-3.—The three gateways and their serving bulk mail centers.**

<b>GATEWAY</b>	<b>SERVING BMC</b>
New York, NY APO/FPO AE 090__ - 098__	New York, International and Bulk Mail Center
Miami, FL APO/FPO AA 340__	Jacksonville, FL
San Francisco, CA APO/FPO AP 962__ - 965__ - 966__	San Francisco, CA

onward dispatch of mail. This is in addition to the usual mail-handling and postal finance functions.

## FLEET MAIL CENTERS

A fleet mail center (FMC) receives, distributes, consolidates, transfers, and dispatches military mail for transportation to, from, and within overseas areas, commands, and ships.

In addition to mail-handling and routing services, FMCs provide port visit instructions, postal training, and inspection services for fleet units and other post offices locally served as required by higher authority.

The lack of an official designation as an FMC does not prevent shore-based or fleet mobile post offices from performing FMC functions when warranted. However, all shore-based Navy post offices must provide assistance to fleet units visiting or operating in geographic areas for which they are responsible.

An FMC is under the military command of the commanding officer of the activity at which it is located. FMCs and MPOs perform functions assigned by the respective Fleet Commander in Chiefs (FLTCINCs). FMCs or Navy post offices (NPOs) designated as mail control activities (MCAs) must also assume those responsibilities as outlined in the *Department of Defense Postal Manual*, DOD 4525.6-M, Volume I, chapter 10.

The FMCs are administered by an officer-in-charge (OIC). This officer maintains liaison with foreign officials concerned with movement of mail, with representatives of commercial transportation carriers, and with local U.S. military postal representatives. The officer-in-charge also assists the FLTCINC in the administration and operation of the MPS. A Senior or Master Chief Postal Clerk is usually assigned and may fill the officer-in-charge billet. The leading chief is directly in charge of the sections that compose the FMC.

The FMCs are usually divided into several sections that include the following:

- Mail-handling section
- Registry section
- Postal Supply
- Administrative section
- Locator
- Claims & Inquiries

- Finance services section

## AERIAL MAIL TERMINALS

Aerial mail terminals (AMTs) are overseas military mail facilities responsible for the receipt, distribution, transfer, and dispatch of military mail by air between overseas areas or to or from the United States.

*Q1-6. The JMPA's act as the single point of contact for the MPSA with what activity?*

*Q1-7. The lack of an official designation as a fleet mail center does not prevent a shore-based post office overseas from performing FMC functions when warranted. (True/False)*

Now turn to appendix 1 to check your answers.

## POSTAL PERSONNEL

---

**Learning Objective:** *Recognize the role of the Navy postal clerk; identify the qualifications and positions of MPS personnel.*

---

The mission and functions of the Military Postal Service would be impossible to achieve without qualified postal personnel. Navy postal personnel responsibilities are many and varied. You will find these responsibilities outlined in the Department of Defense and Department of the Navy regulations and instructions. Also, USPS publications list additional responsibilities, guidelines, and operating procedures. In addition to postal duties, postal personnel are charged with military duties and responsibilities. All too often we forget that we are Sailors first. This does not mean that our professional duties should take a backseat to our military duties; however, they should be performed together in a professional manner. Some of the general responsibilities and titles of postal personnel you will be closely working with are listed in the following paragraphs.

## THE POSTAL CLERK RATING AND RESPONSIBILITIES

Postal Clerks operate post offices aboard Navy ships, and at overseas naval activities. The Navy also

operates a postal finance station at Naval Station, San Diego, CA.

The first postmaster general, Benjamin Franklin, established the tradition that the U.S. mail is a service to all the people of the United States, which should be used as often as needed and rendered at the lowest possible rates. Service is still the primary mission of the USPS. It is your primary function to see that your shipmates receive the same benefits of service through the Military Postal Service. In performing this function efficiently, you will contribute greatly to the morale of your command.

As a Postal Clerk, you need a broad knowledge of military postal operations and a detailed knowledge of postal jobs.

An important phase of postal operations is the movement of mail. Outgoing mail must be dispatched with speed and efficiency to ensure that transportation schedules are met. Incoming mail must be processed quickly to avoid delay in delivery. How you handle your incoming and outgoing mail will, in large measure, decide the reputation of your post office.

Postal counter work is basically a matter of public contact. It requires businesslike behavior, courtesy, and efficient service to personnel served. Clerks must possess a thorough knowledge of postal regulations concerning the types of postal services offered, postage rates, and proper packaging and contents of all classes of mail acceptable for transshipment through the mails.

You will also keep records and prepare reports, as required by the USPS, the Department of the Navy, and the MPSA in relation to post office operations. Operation of a post office includes the upkeep of equipment, ordering supplies, and maintaining post office spaces.

You must have a thorough knowledge of the Department of Defense, Department of the Navy, and U.S. Postal Service security regulations. You are responsible for the safekeeping of the mail, postage stamps, accountable equipment, stamped paper, and blank money order forms in your custody, and cash that is entrusted to you. You are also responsible for disposing of postal effects during an emergency. Financial responsibility involves the custodial accounting, inspection, and supervisory functions required in proper handling of postal effects as well as records of financial transactions such as the sale and payment of postal money orders and the collection of customs duties.

You will also arrange, through the postal officer, transportation for the dispatch and pickup of mail from post offices or other locations ashore and afloat.

In addition to your professional duties as a military postal clerk, you perform military duties. Aboard ship, Postal Clerks have assignments under the watch, quarter, and station bill (as all the crewmembers have) that are unrelated to their postal duties.

You may serve in a variety of billets on small ships such as DDDs or CGs or on larger ships such as LHDs or CVNs. Or you may also be assigned to duty at an overseas activity that has a Navy post office, such as Naples, Italy, or Yokosuka, Japan.

As you prepare for advancement, your responsibilities for naval leadership will increase, as will the applications of leadership to the duties of your rating.

Your responsibilities for technical leadership arise from the nature of your work. Keeping the ship's post office operating efficiently and its financial affairs in good order is a large task. You perform this task effectively when you accept the responsibility of performing every detail of your work with complete integrity and reliability and when you continue to increase your knowledge of a military postal clerk's job.

Integrity of work is a key factor in technical leadership; all other factors relate to it in some way. Integrity of work refers to big things and little things such as the way you supervise the post office, the way you handle your stamp or money order accounts, the way you issue stamps or money orders, the accuracy and neatness of your records, your ability to move mail rapidly, your ability to process inquiries and complaints quickly and knowledgeably, and the manner in which you conduct daily transactions with customers.

When you perform every job as efficiently as you can, and constantly strive to increase your skills and broaden your knowledge, you are demonstrating integrity of work in a concrete practical way. You are also demonstrating technical leadership.

Integrity also involves financial responsibility. This means continuous accurate accounting for all postal funds. The first and most important thing a military postal clerk must learn is the seriousness of this responsibility. To borrow even a small amount from postal funds or to be careless in handling these funds is the first step into serious trouble.

Integrity and financial responsibility are so important in operating a post office that military postal clerks must avoid any practice in their personal lives that might lead into financial difficulties and cast doubt on their honesty.

Do not gamble. If you were to gamble and lose heavily, you might be tempted to do the first dishonest thing you ever did. If you were a big winner and spent the money freely, someone is sure to suspect that you were using your postal funds to make money. Either way you would lose. People just don't trust a gambler to work around money. Besides not gambling, military postal clerks must demonstrate financial responsibility. They must live within their income, pay their bills, and refrain from borrowing or lending money to shipmates.

The MPSA and the Office of the Commander, Naval Supply Systems Command (NAVSUP) have given special attention to detecting and preventing cases of embezzlement among postal personnel. In most cases, postal personnel convicted of offenses involving money have not only received prison terms, but have also lost their opportunity for naval careers. The social stigma of such a conviction follows a person into civilian life and often interferes with getting a responsible job. Usually the persons involved started with no real intent to be dishonest. They just wanted to borrow a little money and pay it back in a few days. But in each case the problem stemmed from a lack of financial responsibility and integrity on the part of the person concerned.

## QUALIFICATIONS

Personnel who perform postal duties must be loyal, trustworthy, and honest. By agreement between the USPS and the Department of Defense, personnel of questionable integrity may not be assigned to duties in MPOs, mailrooms, mail terminals, or other postal facilities.

Navy personnel designated as military postal clerks must meet the following qualifications:

- Have no record of conviction by courts martial or punishment under Article 15 involving a postal-related incident.
- Have no record of civilian conviction other than minor traffic violations.
- Have no record of derogatory information or unfavorable conduct that casts doubt on the military member's trustworthiness and honesty.

- Possess high moral standards and excellent military bearing.
- Have no history of psychiatric disorder, alcoholism, or drug abuse, unless a medical evaluation determines the condition no longer exists.
- Be financially responsible.
- Not have been relieved previously for cause or criminal convictions from military postal duties.
- Be a U.S. citizen and eligible for a SECRET clearance (a favorable Entrance National Agency Check (ENTNAC) or National Agency Check (NAC) is on file) if required to handle official registered mail.
- Not have physical restrictions prohibiting duty involving prolonged standing, walking, or lifting of weights up to 70 pounds.
- Have a physical profile serial code [Pulmonary, Upper Extremity, Lower Extremity, Hearing, Eyes, and Psychology (PULHES)] of 211221 (this is the maximum score). This profile code is established by using a system that indicates the numerical code, corresponding with the above list.

Military postal clerks are designated according to procedures in chapter 4, *Department of Defense Postal Manual*, Volume I.

## MILITARY POSTAL CLERKS

A military postal clerk (MPC) is a person of the U.S. Armed Forces who has been officially designated and authorized by public law to perform postal finance functions and other postal duties. The term *military postal clerk* includes Army, Navy, Air Force, Marine Corps, and Coast Guard postal clerks. Navy personnel designated as military postal clerks need not necessarily be of the Postal Clerk rating. Members of other Navy ratings or non-designated, non-rated personnel may be designated as military postal clerks if the situation warrants, or if the personnel concerned are striking for the rating of Postal Clerk.

## PROSPECTIVE RELIEF

All Navy commands that operate a post office must have at least one primary military postal clerk designated. If only one MPC is assigned, which is the case aboard some ships, an alternate MPC will be

designated locally. The alternate MPC should be available to carry out postal functions in the absence of the primary MPC or when it becomes necessary to assist the primary MPC. Personnel selected as alternate MPCs must meet the qualifications as for MPCs. Personnel selected as alternate MPCs need not be of the Postal Clerk rating or designated strikers.

## **MAIL CLERK**

Mail clerks are individuals assigned to do mail duties at unit mailrooms (UMRs) according to DOD regulations. When mail is in their possession, mail clerks must safeguard mail at all times.

Mail clerks pick up mail from a military post office and deliver it to members of their unit. Mail clerks also maintain a mail directory file at the UMR. The directory file must show the names of all personnel being served, scheduled to arrive, assigned temporary duty, and transferred personnel. After their departure, personnel should have directory service given to their mail for 12 months or 3 months if assigned for a period of 6 months or less. Mail clerks must ensure transferring personnel complete an additional change of address card for filing with the serving post office. If necessary, the transfer section of a command can help in this matter. Positive training must be supplied to mail clerks by unit postal officers and UMR supervisors. For further guidance, refer to the *Department of Defense Postal Manual, Volume II*.

## **MAIL ORDERLY**

Mail orderlies are individuals from divisions, departments, squadrons, or commands who are assigned to pick up mail from a post office or unit mailroom. Aboard ship, the mail orderly will go to the post office where mail is distributed during mail call. Prior to receiving mail, the mail orderly must provide proof of identification. Ask the mail orderly to show a DD Form 285. This form along with the mail orderly's identification card is enough.

Mail-handling training must also be supplied to mail orderlies. U.S. citizenship is mandatory, and the person must be eligible for a Secret Clearance (an Entrance National Agency Check or National Agency Check is on file) if required to handle official registered mail. Further instructions are given in the *Department of Defense Postal Manual, Volume II*.

## **FINANCIAL POSTAL CLERK**

A Financial Postal Clerk is a DOD civilian employee in an overseas shore-based military post office who has been assigned custody and accountability of a portion of the post office's stamp and money order account. A financial postal clerk also sells postage stamps and other stamped paper (stamped cards, stamped envelopes, and so forth), sells and redeems postal money orders, and accepts and delivers accountable mail as well as performs such other postal duties as are assigned by proper authority.

## **CUSTODIAN OF POSTAL EFFECTS**

At each command that operates a post office a member or DOD civilian employee of the U.S. Armed Forces will be designated as a custodian of postal effects (COPE). The COPE is accountable for the stamp stock and other postal effects issued to that post office by the USPS. Civilian employees who are designated as the COPE should be under the direct supervision of a military supervisor. At some time in your career you may become the command COPE.

## **RESERVE CUSTODIAN**

A reserve custodian is a commissioned officer or postal clerk (E-7 or above) designated in writing by the commanding officer to hold a portion of the assigned stamp stock (stamps and cash) and blank money order forms. A reserve custodian should be designated when conditions do not allow the COPE to properly protect postal effects, such as shipboard operations, or when the commanding officer desires to limit the amount of stamp stock to be held by the COPE. Aboard smaller ships the disbursing officer is normally designated as the reserve custodian.

## **MONEY ORDER VERIFICATION OFFICER**

The money order verification officer is a person (E-7 or above) designated in writing by the commanding officer and is responsible for conducting the audit of the daily money order business report. Aboard ship the money order verification officer is normally the disbursing officer.

## **POSTAL OFFICER**

The postal officer is a person (E-7 or above) designated in writing by the commanding officer with responsibility for the overall supervision of the postal

operation within that command. Postal officer duties include:

- Becoming thoroughly familiar with USPS and DOD directives and regulations, as well as all Navy postal instructions and directives.
- Reviewing post office records and materially inspecting postal facilities weekly.
- Randomly checking mail directory service to ensure compliance with the *Department of Defense Postal Manual*, DOD 4525.6-M, volume II, chapter 6.
- Being present during all postal audits.
- Possible assignment to the monies audit board if no postal account is held.
- Asking for aid from postal assistance advisors as often as needed.

### MONIES AUDIT BOARD

The command monies audit board consists of personnel designated in writing by the commanding officer of which one may be the postal officer, to perform monthly audits of the post office. During these audits at least 2 auditors must be present to verify all postal accounts and to ensure all accountable equipment assigned to the NPO is accounted for.

### POSTAL ASSISTANCE ADVISORS

Postal assistance advisors are senior Navy Postal Clerks or DOD civilian employees who are assigned by FLTCINC postal officers to selected commands where there are large concentrations of ships in the United States and overseas. They are there to provide guidance to commanding officers and postal officers, and to assist postal clerks with questions concerning the daily operation of post offices and to give additional training to assigned postal personnel as needed.

Each post office operated by the Navy should be visited at least once every 18 months by a postal assistance advisor. In addition, each ship that has a post office aboard should have a postal assistance visit before any scheduled extended deployment.

- Q1-8. Name at least three qualifications required of Navy personnel to be designated as a military postal clerk.*
- Q1-9. Navy personnel that are designated as military postal clerks must be of the postal clerk rating. (True/False)*

*Q1-10. What is the main task of a reserve custodian?*

*Q1-11. Who is normally assigned as the reserve custodian aboard a smaller class ship?*

*Q1-12. A command postal officer is designated in writing by what official?*

*Q1-13. Who should you consult if you are having postal problems or if you have any questions relating to postal matters?*

Now turn to appendix 1 to check your answers.

### TRAINING

---

**Learning Objective:** *Identify postal training facilities.*

---

A Postal Clerk “A” course is taught under the sponsorship of the U.S. Army. This is an inter-service school that trains prospective military postal clerks for all branches of the armed services. The school is currently located at Fort Jackson, SC. The course provides enlisted personnel with a working knowledge of the techniques and procedures involved in the operation of a military post office. In addition to meeting the qualifications for a military postal clerk, Navy personnel scheduled to attend the course must have a minimum of 1 year or more of active duty service remaining after completion of the course.

In addition to the PC “A” school, there is also a postal supervisor course offered for personnel primarily at the PO2 level. This course is also located at Fort Jackson, SC.

*Q1-14. Under the sponsorship of what military department is the Postal Clerk “A” school taught?*

Now turn to appendix 1 to check your answer.

### SOURCES OF INFORMATION

---

**Learning Objective:** *Identify essential Department of the Navy, Department of Defense, and United States Postal Service publications and manuals.*

---

Before you begin working a postal finance window accepting articles for mailing, issuing money orders,

and handling mail, there are several publications and manuals with which you must become familiar and know how to use. These publications are issued by the DOD, the Department of the Navy, and the USPS. By becoming familiar with them, you can obtain much valuable information. You will find almost all information and instructions issued through these publications. There may not be anyone else to turn to for such advice, especially if you are deployed, on independent postal duty, and acting as the command COPE.

However, a publication is of no assistance if it or any of its pages are missing, or if the latest changes have not been entered. You should keep your publications in an orderly condition and up to date. Changes should be entered as soon as possible after receipt. Handling, correcting, and using official publications and manuals are routine duties of a Postal Clerk. Because these duties are routine, you may underestimate their importance. This is a serious mistake.

In this section we will discuss those publications and manuals you will use in performing postal duties. These same publications and manuals are the sources of information for developing this training manual. Some of these publications and manuals are automatically distributed to commands. Others may be ordered through the USPS Material Distribution Center (MDC), Navy supply channels, your supply or administrative officer or obtained through USPS or DOD web sites.

## **DEPARTMENT OF DEFENSE POSTAL MANUAL**

The *Department of Defense Postal Manual*, DOD 4525.6-M, is published by MPSA to provide guidance to all military departments for the administration and operation of the Military Postal Service (MPS). The DOD Postal Manual is published in two volumes, each of which is issued separately.

Volume I contains policies and procedures issued by the MPSA for the operation of a military post office. You will be primarily concerned with the information in the following chapters:

- Chapter 4, “Selection and Designation of Military Post Office Personnel”
- Chapter 5, “Postage Stock”
- Chapter 6, “Postage Meters”

- Chapter 7, “Money Orders”
- Chapter 8, “Processing and Transportation of Registered Mail”
- Chapter 9, “General Operating Procedures at Military Post Offices”
- Chapter 10, “Processing and Makeup of Mail”
- Chapter 11, “Mail Transportation”
- Chapter 12, “Audits and Inspections”

Volume I is automatically distributed only to those commands that operate a military post office.

Volume II provides instructions for delivery of mail through unit mailrooms or by the mail orderly system at the unit/ship level. Topics include selection and appointment of unit mailroom and mail orderly personnel, mail delivery and accountability procedures, security and directory services. You will be primarily concerned with information in the following chapters:

- Chapter 3, “Administrative and Operating Procedures”
- Chapter 4, “Receipt and Delivery of Mail at Military Post Offices, Unit Mailrooms, and Postal Service Centers”
- Chapter 6, “Directory Service”

Volume II is automatically distributed to all commands that are on normal distribution for publications.

## **NAVY POSTAL FINANCE OFFICE HANDBOOK**

The Navy Postal Finance Office (NPFO) Handbook is issued by NAVSUP to supplement the DOD and Navy postal instructions. This handbook provides detailed instructions ranging from ordering stamps and money orders to submission of required audits and reports. It also provides detailed instructions for preparing various postal forms.

## **DEPARTMENT OF THE NAVY POSTAL INSTRUCTION**

The *Department of the Navy Postal Instruction* OPNAVINST 5112.6 is issued by NAVSUP as a supplement to the *Department of Defense Postal Manual*, Volumes I and II. This instruction addresses Navy unique situations and gives additional guidance in the administration of Navy post offices. This



instruction is binding upon all personnel of the Navy/Marine Corps and other individuals or agencies who are users of Navy postal facilities.

## DOMESTIC MAIL MANUAL

The *Domestic Mail Manual* (DMM) is our basic guide in the Military Postal Service. It sets forth the regulations and procedures governing the domestic mail services offered to the public by the USPS. The DMM consists of a DMM Utilities that gives step-by-step instructions on how to use the DMM, and the 12 subject modules (tab dividers) arranged in alphabetical order except for the Index. These modules include:

- A - Addressing
- C - Characteristics and Content
- D - Deposit, Collection, and Delivery
- E - Eligibility
- F - Forwarding and Related Services
- G - General Information
- L - Labeling Lists
- M - Mail Preparation and Sortation
- P - Postage and Payment Methods
- R - Rates and Fees
- S - Special Services
- I - Index Information

Material in the DMM is organized in an alphanumeric numbering system. At the top left-hand side of the page you will notice a number, which shows the first paragraph of that page. The number, which

appears on the top right-hand side, shows the last paragraph of that page.

Look at the letters and numbers in figure 1-2. The first letter “C” refers to module C. The next three numbers identify the basic subject of module C; and “010” refers to General Mailability Standards. The fourth digit refers to a more specific subject called a part, which, in this example, is Part 2, entitled “Packaging.” The fifth and final digit is a section, numbered here as “1,” referring to packaging adequacy.

This publication is automatically distributed to all commands operating military post offices.

## INTERNATIONAL MAIL MANUAL

The *International Mail Manual* (IMM) contains detailed information concerning international postal rates. It lists special mailing prohibitions, import restrictions, and other mailing conditions applicable to mail sent from an MPO or U.S. post office to a foreign country. It also contains individual country listings arranged alphabetically. Since you must refer to the IMM for each article addressed to a foreign country, this manual will be discussed in detail in chapter 6. The IMM is also automatically distributed by the USPS to commands operating a military post office.

## ADMINISTRATIVE SUPPORT MANUAL

The *Administrative Support Manual* (ASM) contains policies and procedures for USPS administrative and support functions including postal organization, audits and investigations, communications, relations with other organizations, facilities and equipment, support services, purchasing and materials, and information resources. This

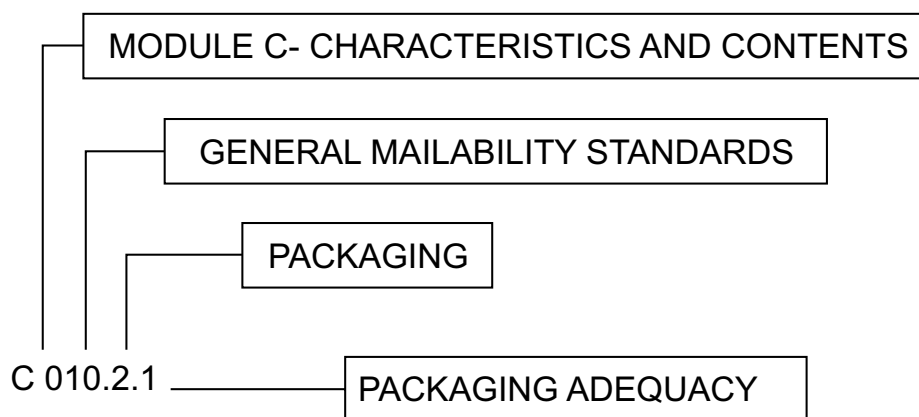

Figure 1-2.—Domestic Mail Manual alphanumeric system.

PCf0102

publication is automatically distributed to all commands operating military post offices.

### **POSTAL OPERATIONS MANUAL**

The *Postal Operations Manual* (POM) sets forth the policies and procedures for the operational functions of the USPS post offices. This manual consists of eight chapters and a forms index. The chapters contain information on retail management, philately, collection service-national service standards, mail processing procedures, mail transportation, delivery services, postal vehicle service, and special services. The forms index lists all forms related to the POM. You will find the POM supplements the DMM and much of the information given pertains to USPS Post Offices and not the military. The POM is automatically distributed by the USPS to all commands that operate a post office.

### **NATIONAL FIVE-DIGIT ZIP CODE AND POST OFFICE DIRECTORY**

The U.S. Postal Service publishes the *National Five-Digit ZIP Code and Post Office Directory*, Publication 65-A, annually to furnish correct and current ZIP Code and mailing information to the mail user and the public in general. This directory contains complete information relating to the five-digit ZIP Code system and information required by the mailer concerning USPS facilities and organization. This publication is automatically distributed to all commands operating military post offices.

ZIP Codes are five-digit code numbers placed in addresses to identify the specific post office to which each article will be delivered. Each post office throughout the United States has its own ZIP Code. Through the use of ZIP Codes, sorting and movement of mail can be quickly accomplished. If you receive an article at your MPO window without a ZIP Code, you should direct the person presenting the article for mailing to the National Five-Digit ZIP Code and Post Office Directory. This directory is organized into 2 volumes containing 13 sections and 7 appendices with sections 3 (state list of post offices and post offices with street listings) and 12 (address formats for overseas mail) being those most generally used to locate ZIP Codes.

### **PUBLICATION 52—ACCEPTANCE OF HAZARDOUS, RESTRICTED, OR PERISHABLE MATTER**

Publication 52 is a must to have in any military post office. This publication is a reference handbook used by Postal Clerks to determine under what conditions hazardous, restricted, and perishable materials may be accepted for mailing.

### **DISTRIBUTING, DISPATCHING AND TRANSPORTING MILITARY MAIL BY AIR (HDBK T-7)**

This handbook is applicable to all personnel of the USPS, air carriers, and the DOD who are responsible for handling, processing, dispatching, and transporting military mail to and from the United States and between military postal units overseas.

### **DIRECTIVES AND FORMS CATALOG (PUB-223)**

This catalog lists all national Postal Service directives and forms, as well as non-postal government forms and documents used by the Postal Service. This catalog will be used when preparing requisitions and when performing inventory of supplies.

### **SUPPLY AND EQUIPMENT CATALOG (PUB-247)**

This catalog lists all supply and equipment items available from the USPS. Instructions for ordering along with photographs, descriptions, dimensions, and weights of individual items are provided to allow for easy identification of required supplies.

### **REQUISITIONING LABELS (HDBK PO-423)**

This handbook is designed to provide instructions regarding requisitioning label products through the USPS. It provides label product information and label ordering procedures. It is essential to keep this guide current.

### **CONTAINER METHODS (HDBK PO-502)**

This handbook provides information concerning the USPS containerization policy, operating descriptions of all USPS containers, uses of USPS containers, the relationship of container use to other

USPS operations, and Mail Transport Equipment (MTE).

You will be primarily concerned with chapter 2, “Container Descriptions and Applications,” as it applies to procedures for properly handling empty equipment for storage and shipping as it becomes necessary.

### **EXPRESS MAIL MILITARY SERVICE (HDBK PO-514)**

The Express Mail Military Service Handbook is used by overseas military postal activities for the processing of Express Mail. This handbook is available through USPS supply channels.

### **FINANCIAL MANAGEMENT REGULATION**

The DOD Financial Management Regulation provides all DOD components with the policy, regulations, and procedures within the area of responsibility of the Under Secretary of Defense (Comptroller). MPCs need only be familiar with volume 5, chapter 7, of this manual.

### **POSTAL BULLETINS**

The *USPS Postal Bulletin* is published bi-weekly at Postal Service Headquarters in Washington, DC. Special issues are published as needed. It is made up in newspaper format (see figure I-3). It contains official information (temporary instructions, special instructions, changes to USPS manuals, new USPS forms, stolen money order list, and so on) as well as other information of general interest to postal personnel. All military post offices receive the Postal Bulletins. Each copy should be filed and kept available for ready reference for at least 1 year.

### **STANDARD NAVY DISTRIBUTION LIST**

The *Standard Navy Distribution List* (SNDL) is published by the office of the Chief of Naval Operations (OPNAV) to provide for the proper addressing and distribution of mail to Chief of Naval Operations (CNO) and Secretary of the Navy (SECNAV), formally established activities as well as other miscellaneous DOD and DON activities, and to provide a central distribution system for directives and correspondence. The SNDL is published electronically in two parts:

Part 1—part 1 is entitled, “Standard Navy Distribution List, Operating Forces of the Navy, Unified and Specified Commands, U.S. Elements of International Commands,” OPNAVNOTE 5400.

The following information may be found in part 1:

- A list of ships by name alphabetically
- A list of commands by SNDL list numbers
- Annex A, which contains a list of Military Sealift Command ships and their FPO addresses
- Plain Language Address (PLA)
- Unit Identification Codes (UIC)

Part 2—part 2 of the SNDL the, “Catalog of Naval Shore Activities,” OPNAVNOTE 5400, contains distribution lists for the Navy Department and all CNO and SECNAV formally established shore activities. Each symbol represents a type of naval activity. The originator, by listing the appropriate SNDL numbers or letter-number combinations, notifies the distributing office what activities should receive the material. The listings are included at the end of the publication, directive, or letter.

Revisions and Changes—The SNDL is reissued quarterly on CD-ROM via the OPNAV/SECNAV directive process or is available on the OPNAV/SECNAV directives website or commands can receive a monthly update by providing a 3 1/2 floppy disc to CNO-OP09B22. Serial changes are provided to commands that want to maintain an updated SNDL and who process large volumes of mail that require up-to-date information. This publication is maintained by the administrative department.

### **NAVY NOTICES AND INSTRUCTIONS**

A directive is a written order printed and distributed. Certain Navy publications are issued through the Navy Directives Issuance System, which provides a uniform method of issuing directives by all activities in the Navy. The types of directives used in this system are instructions and notices. Instructions and notices are defined briefly here to assist you in identifying other publications issued as instructions.

An instruction is a type of directive that is permanent in nature or it remains in effect until replaced or canceled by the originator or higher authority.

A notice is a directive of a one-time nature or one that contains information or action for a brief time

# POSTAL BULLETIN

PUBLISHED SINCE MARCH 4, 1880

PB 22015, JANUARY 13, 2000

## CONTENTS

The *Postal Bulletin* is also available on the World Wide Web at <http://www.usps.com/cpim/ftp/bulletin/pb.htm> for customers and at <http://blue.usps.gov> for employees..

### Administrative Services

ASM Revision: Associate Office Infrastructure Field Support Responsibilities..... 2

### Child Alert Program

Missing Children Posters..... 3

### Customer Relations

Mail Alert..... 13

### Domestic Mail

DMM Revision: Adding Delivery Confirmation to Return Receipt for Merchandise and Merchandise Return Service..... 14  
Reminder: Mailability of Firearms..... 18  
New Special Service Labels..... 20  
New Issue of the *Domestic Mail Manual*..... 20  
APO/FPO Changes..... 21  
Drop Shipment Management System..... 21

### Finance

Revenue Unit for Fiscal Year 1999..... 32  
Federal Tax Withholding Exemption..... 32  
Postal Employee Use of Citibank VISA Travel Cards..... 32

### Fraud Alert

Foreign Order No. 442..... 33  
Withholding of Mail Orders..... 33  
Missing, Lost, or Stolen U.S. Money Order Forms..... 34  
Missing, Lost, or Stolen Canadian Money Order Forms..... 38  
Counterfeited Canadian Money Order Forms..... 40  
800 Number Available to Verify Canadian Money Orders... 40  
Invalid Express Mail Corporate Account Numbers..... 41

### International Mail

Reminder: International Mail — Customs Form Usage..... 44

### Philately

Pictorial Cancellations Announcement..... 46  
Millennium Pictorial Cancellations — Additional Participating Offices..... 48  
Special Cancellation Die Hubs..... 50

### Post Offices

Post Office Changes..... 51  
POM Revision: Zip Code Authorization and Assignment..... 51  
Washington Birthday Poster..... 75

### Purchasing and Materials

Ordering Procedures for Postmarking Ring Dies and Die Hubs..... 77  
Thrift Savings Plan (TSP) Open Season Material..... 78  
Interest Rate on Contract Claims..... 78

### Retail

What's in Store..... 79  
Revenue Measurement: Walk-In Revenue Definition..... 85  
Correction: Dinero Seguro..... 85  
Items Authorized for Sale in Self Service Vending Machines..... 86

### Postal Bulletin Index

Quarterly Index..... PB 22011 (11-18-99)

**Ordering Information:** Following is the list of postal stock numbers (PSNs) to use when ordering copies of the *Postal Bulletin* from the MDCs:

PB 22015: 7690-04-000-3994	PB 22002: 7690-04-000-3981
PB 22014: 7690-04-000-3993	PB 22001: 7690-04-000-3980
PB 22013: 7690-04-000-3992	PB 22000: 7690-04-000-3979
PB 22012: 7690-04-000-3991	PB 21999: 7690-04-000-3978
PB 22011: 7690-04-000-3990	PB 21998: 7690-04-000-3977
PB 22010: 7690-04-000-3989	PB 21997: 7690-04-000-3976
PB 22009: 7690-04-000-3988	PB 21996: 7690-04-000-3975
PB 22008: 7690-04-000-3987	PB 21995: 7690-04-000-3974
PB 22007: 7690-04-000-3986	PB 21994: 7690-04-000-3973
PB 22006: 7690-04-000-3985	PB 21993: 7690-04-000-3972
PB 22005: 7690-04-000-3984	PB 21992: 7690-04-000-3971
PB 22004: 7690-04-000-3983	PB 21991: 7690-04-000-3970
PB 22003: 7690-04-000-3982	PB 21990: 7690-04-000-3970

**The *Postal Bulletin* is published biweekly; information is effective for one year unless it changes the text of permanent directives or unless otherwise specified.**



186-619 00 - 1

PCF0103

Figure 1-3.—USPS Postal Bulletin.

only. A notice usually remains in effect for less than 6 months, but is not permitted to remain in effect for longer than 1 year.

Instructions and notices concerning postal matters are numbered 5110 through 5119 in the *Standard Subject Identification Codes* (SSICs) used by the Navy. The following are the codes and their titles:

- Mail and Postal Affairs
- Policies
- Regulations
- Liaison
- Transportation
- Losses and Claims
- Complaints
- Equipment
- Customs and Contraband
- Postal Operations

## CHANGES TO PUBLICATIONS

When information changes within the USPS/MPS, publications become out of date and useless unless new information is incorporated into the publications. Changes will normally be received by letter of transmittal, naval message, or by the USPS *Postal Bulletin*.

Changes and corrections are made by inserting new pages, removing obsolete pages, or making pen-and-ink changes in the existing book. When making changes to a DOD or OPNAV instruction, the change should be entered in the text and a copy of the complete change should be placed in the front of the instruction with the date the change was made and the initials of the clerk making the change. A publication that is not up to date or one that has been changed incorrectly may be useless because it can give you wrong directions.

When a list of effective pages is included with a change, it is important that you check all pages against the checklist. This procedure enables you to determine if your publication is correct.

You will use the various publications mentioned already in this section as you learn your job. They are references to which you will turn for information about correct procedures. In any military post office, you need the answers to numerous questions. You cannot

possibly remember all these answers, and in fact you should not try to do so. Instead, you should know where to locate the information. The better you know your postal manuals and publications, the quicker you will be able to find the information you need.

*Q1-15. What publication is published by MPSA to provide guidance for postal operations within the Military Postal Service?*

*Q1-16. You receive an article at your MPO without a ZIP Code. What publication should you consult to find the proper ZIP Code?*

*Q1-17. What information do USPS Postal Bulletins provide military postal clerks?*

Now turn to appendix 1 to check your answers.

## ENTITLEMENT TO USE MILITARY POSTAL FACILITIES

---

**Learning Objective:** *Identify the various personnel authorized to use MPS facilities and the identification required.*

---

The fact that a person has access to a naval activity does not, in itself, mean entitlement to use facilities aboard that activity. This includes postal facilities. The Department of Defense has established a single policy defining the organizations, agencies, and personnel entitled to use the facilities of the Military Postal Service. Procedures are set up to carry out this policy.

Personnel on active duty in the U.S. Armed Forces are authorized to use the Military Postal Service. Various other persons and agencies are also authorized, some regularly and some only in specific circumstances. You must understand situations when regular authorizations apply and the conditions that justify special authorization.

The establishment, operation, and use of the U.S. Military Postal Service in sovereign foreign countries depend upon an agreement with the host government, since it is customary among nations to preserve a monopoly of postal services. International agreements permitting establishment of military postal facilities usually specify limiting the use of such facilities to the armed forces and certain civilian agencies and organizations serving with or related to the armed

forces. Additional information concerning use of the Military Postal Service is found in the *Department of Defense Postal Manual*, DOD 4525.6-M, Volume I, appendix A.

## **AUTHORIZED PERSONNEL**

Control of personnel who use a post office aboard a ship is much easier than at a post office located on a naval activity in a foreign country. This is because of the limited access that personnel have to ships. So if you are assigned to a post office that is located in a foreign country, you should be particularly alert for unauthorized users. Violations of any agreement with the host country could place the Military Postal Service in that country in jeopardy.

## **SERVICE FOR RELATED ORGANIZATIONS**

At naval activities overseas, there may be several organizations present that are not part of the DOD, but do support a DOD mission. The U.S. citizen employees of these organizations and their accompanying dependents are authorized to use the Military Postal Service outside of the Continental United States (CONUS) where the USPS does not operate. Some of the organizations that may be located in your area are as follows:

- DOD operated dependent schools
- DOD non-appropriated fund activities
- The American Red Cross
- United Service Organizations, Inc. (USO)
- Overseas military banking facilities and credit unions
- Masters and civilian crews of the Military Sealift Command (MSC) ships and merchant ships operating for the account of the MSC

Other categories of personnel may be entitled to use military post offices under certain conditions at overseas locations, so you should check your local regulations for entitlement.

## **UNAUTHORIZED PERSONNEL**

Organizations and personnel authorized to use the MPS may not mail articles for persons and organizations not authorized postal services. The following organizations and individuals are among those that will NOT be provided postal services:

- Concessionaires of non-appropriated fund activities.
- Political organizations. This does not prohibit direct mailing of political campaign material to individuals authorized to use the MPS, provided it is not material for distribution on or off the military installation.
- Non-DOD tuition-fee schools.
- Non-appropriated fund activities of non-DOD agencies, such as employee cooperatives.
- Non-DOD contractors.
- Individuals, whether otherwise entitled to such service or not, for business or commercial purposes.

If postal privileges are to be withdrawn from previous authorized organizations and individuals, a 90-day advance notice of withdrawal of service should normally be given.

## **EMERGENCY OR SPECIAL AUTHORIZATIONS**

In the event of a national emergency, hostilities, or occupations, U.S. citizen personnel, not otherwise allowed the use of the MPS under any other provisions, may be authorized use of the facilities for letter class mail including stamped cards, post cards, and voice recordings.

Such persons must be in overseas areas where international postal service is not available or adequate. If adequate international postal service later becomes available, use of the MPS should be withdrawn.

When, in time of peace, if it appears that persons or organizations should be authorized to use the MPS, requests for this authority should be submitted to the MPSA. Such requests originate from the commanding officer, and should include the comments and recommendations of the responsible theater or overseas area commander, together with a statement concerning eligibility under any existing agreement between the United States and the host country.

*The Overseas Citizens Voting Rights Act of 1975* was amended by *Public Law 95-593* to allow U.S. citizens overseas access to military post offices for the purpose of mailing balloting material. This service is for those U.S. citizens overseas who are not normally authorized Military Postal Service privileges. The

**Figure 1-4.—Types of identification cards issued by the Department of Defense.**

CARD TITLE	DD FORM	ISSUED TO	PRINTED COLOR
U.S. Armed Forces Identification Card	2N, 2A, 2AF (Active)	Active Duty Personnel	Green
	2N, 2A, 2AF (Inactive)	Reserve Personnel On inactive duty	Red
United States Uniformed Services Identification Card	2 (Retired)	Retired and Fleet Reserve Personnel	Blue (new) Gray (old)
Uniform Services Identification and Privilege Card	1173	Dependents, DOD U.S. Citizen employees, and certain other authorized U.S. civilians	Brown

balloting material must bear an international return address instead of an APO/FPO return address.

**RETIRED MILITARY PERSONNEL**

Retired personnel of the U.S. Armed Forces and their accompanying dependents are authorized to use military postal facilities under the following conditions:

- There is no USPS.
- Such use is not prevented by the host government.
- Postal facilities will not be overburdened by the addition of personnel in this category.

Parcel mail privileges are limited to those parcels weighing less than 1 pound. Once such service is given, it may be withdrawn only when military postal authorities at the department level approve.

**IDENTIFICATION**

All personnel that are authorized to use military post offices must have suitable identification in their possession. So, before you provide service to anyone, and there is doubt as to their entitlement, check their identification to ensure that the person is in fact authorized postal privileges. The various types of identification cards issued by the military departments

are listed in figure 1-4. Personnel holding one of these identification cards may use military postal facilities located in foreign countries unless prohibited by the host country.

At times, persons may be temporarily traveling at the invitation of one of the military departments and not hold one of the identification cards listed in figure 1-4. In this case the person should have travel orders and a passport that may be accepted for identification instead of an identification card.

*Q1-18. Because a person has access to your post office automatically means the person is entitled to use military postal facilities. (True/False)*

*Q1-19. Name at least three organizations that could be located overseas in support of DOD missions and would be considered authorized to use military postal facilities.*

*Q1-20. If postal privileges are to be withdrawn, at least how many days should advance notice of withdrawal of service be given?*

*Q1-21. What type of material could a U.S. citizen, not normally authorized MPO privileges, mail from an overseas MPO to CONUS?*

Now turn to appendix 1 to check your answers.





## CHAPTER 2

# DESIGNATIONS AND TERMINATIONS

In chapter 1, you learned about the qualifications and responsibilities of Navy Postal Clerks. Now we will discuss the designations required to assume the different positions in a military post office and the procedures for completing the Designation/Termination forms.

### SELECTION AND DESIGNATION OF MILITARY POST OFFICE PERSONNEL

---

**Learning Objective:** *Recognize the designations required of personnel involved with operating a Military Post Office (MPO).*

---

Personnel who perform postal duties must be loyal, trustworthy, and honest. By agreement between the USPS and the Department of Defense, personnel of questionable integrity may not be assigned to duties in MPOs, mailrooms, mail terminals, or other postal facilities.

The requirements listed in chapter 1, outlined by the USPS-DOD Postal Agreement, and expanded upon by MPSA apply to all military services. However, they are not intended as an all-inclusive list of qualifications for designation. In addition to the criteria listed in chapter 1, each military service can develop its own selection qualifications to incorporate unique career duty classification requirements.

U.S. civilian personnel and Foreign Nationals also must meet the basic criteria listed in chapter 1 to be designated as MPCs, FPCs, COPEs, or PFOs. Military personnel selected for postal duties who have no previous postal experience should be scheduled to attend a postal course before assuming postal assignment. Personnel selected for key postal positions will receive training before assuming duties. Training should emphasize the importance of the postal service and the need to follow established policies and procedures. The MPS is dependent on well-trained, motivated, and reliable personnel.

### DESIGNATION OF MILITARY POSTAL CLERK

Before being permitted to perform postal financial duties or assuming custody of postal effects, an individual must be designated as a military postal clerk (MPC). Personnel are designated using DD Form 2257, Designation/Termination MPC-FPC-COPE-PFO. See figure 2-1. Personnel will also have a page 13 entry made in their service records. See figure 2-2. All designations must be in accordance with chapter 4 of the *DOD Postal Manual* and the *Department of the Navy Postal Instructions*. Military postal clerks are only designated once in their military career. However you should ensure that when you reenlist, DD Form 2257 and the page 13 entry are retained in your service record.

The appointing official will also issue the designee a DD Form 285, Appointment of Military Postal Clerk, Unit Mail Orderly, to identify the individual as a member of the MPS. The DD Form 285 will be postmarked in block 10 with the all-purpose date stamp (APDS) of the MPO to which the individual is assigned. See figure 2-3.

Figure 2-1 is an example of DD Form 2257 designating an MPC. Use instructions listed below to guide you through the process.

Block 1: Enter the name of the individual being designated as an MPC along with the mailing address of the current command.

Block 2: Enter the complete address of the designee's command.

Block 3: Indicate the position for which the individual is being designated. (In this situation as a MILITARY POSTAL CLERK (MILITARY).)

Block 4: Type or print the designee's full name, pay grade, and branch of service.

Block 5: (For MPCs this block should read: All Military Post Offices.)

Block 6: Have the designee read this statement, sign, and date.

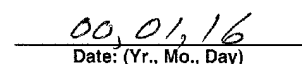
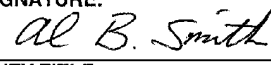
DESIGNATION/TERMINATION MPC-FPC-COPE-PFO		
TO: (Use complete address) ABLE B. SEAMAN USS UNDERWAY (CV-66) FPO AE 09561-0001	①	FROM: (Use complete address) COMMANDING OFFICER USS UNDERWAY (CV-66) FPO AE 09561-0001
DESIGNATION		
THE INDIVIDUAL NAMED BELOW IS DESIGNATED:		
③	<input checked="" type="checkbox"/> MILITARY POSTAL CLERK (MILITARY) <input type="checkbox"/> FINANCIAL POSTAL CLERK (CIVILIAN) <input type="checkbox"/> CUSTODIAN OF POSTAL EFFECTS <input type="checkbox"/> POSTAL FINANCE OFFICER	
NAME: (Last, First, MI) (Typed or printed) SEAMAN, ABLE B.	④	PAY GRADE: E-3 (PCSN)      BRANCH OF SERVICE: U.S. NAVY
ACTIVITY FOR WHICH DESIGNATED: ALL MILITARY POST OFFICES		
⑤		
I acknowledge my designation as shown above, and shall faithfully discharge the duties associated with this designation. I also agree to obey all laws and regulations established by the United States Postal Service and the Department of Defense.		
⑥		
 Signature of Designee		 Date: (Yr., Mo., Day)
TYPED/PRINTED NAME OF DESIGNATING OFFICIAL: (Last, First, MI) SMITH, AL B.	⑦	PAY GRADE: 0-3 SIGNATURE:  DUTY TITLE: POSTAL OFFICER
TERMINATION		
THE ABOVE DESIGNATION IS TERMINATED EFFECTIVE (Yr, Mo, Day):		
REASON FOR TERMINATION (EXPLAIN IN DETAIL):		
TYPED/PRINTED NAME OF TERMINATING OFFICIAL: (Last, First, MI)	PAY GRADE:	SIGNATURE:
		DUTY TITLE:

DD Form 2257, JAN 82 (EG)

Replaces AF Form 1948, Aug 76, which is obsolete.

Designed using Perform Pro, WHS/DIOR, Mar 95  
PCF0201

Figure 2-1.—An example of a military postal clerk designation/termination (DD Form 2257).

Block 7: The Postal Officer will enter name, rank, duty title, and signature.

Figure 2-3 is an example of a DD Form 285. Use instructions listed below to guide you through the process.

Block 1: Date appointee began work at MPO.

Block 2: Leave blank when designating.

Block 3: Type or print the name of the appointee.

Block 4: Type or print the appointee's rank (PCSN) or paygrade (E-3).

Block 5: Type or print the appointee's Social Security Number.

- Block 6: Type or print the appointee's title.

**ADMINISTRATIVE REMARKS**  
NAVPERs 1070/813 (REV. 10-81)  
S/N 0106-LF-010-8991

E-32

SHIP OR STATION  
USS UNDERWAY (CV-66), FPO AE 09561-0001

DATE: Designated as a Military Postal Clerk this date, in accordance with OPNAVINST 5112.6 (Series).

J.R. Doe, PNC, USN, Personnel Officer  
By direction of the Commanding Officer

DATE: I acknowledge my designation as a Military Postal Clerk and shall faithfully discharge the duties associated with this designation. I shall abstain from everything forbidden by the U.S. Postal Service Laws and Regulations and shall honestly and truly account for and pay over any money belonging to the U.S. Postal Service that comes into my possession as a result of this designation.

Able B. Seaman

Witnessed by: J.R. Doe, PNC, USN, Personnel Officer  
By direction of the Commanding Officer

NAME (Last, First, Middle) Seaman, Able B.	SSN 777-77-7777	BRANCH AND CLASS USN
---	--------------------	-------------------------

★ U.S. Government Printing Office: 1985-605-009/26675 2-1

PCf0202

13

Figure 2-2.—An example of a page 13 entry (Administrative Remarks).

Block 7: Type or print the appointee's unit of assignment.

Block 8: Type or print the appointee's unit FPO number.

Block 9: This block is used to indicate what category of mail the appointee is authorized to handle. Check each block that is applicable. Have the appointing official

initial next to the checked block(s) and sign in the signature block. For MPCs, you should check blocks that say, "Official All" and "Personal All."

Block 10: Place the APDS over this block to authenticate appointment. The appointee must sign the signature block.

APPOINTMENT OF MILITARY POSTAL CLERK, UNIT MAIL CLERK OR MAIL ORDERLY <i>(See Instructions on Reverse)</i>		1. DATE EFFECTIVE 00/01/16	2. DATE REVOKED
3. NAME OF APPOINTEE <i>(Last, First, Middle Initial)</i> Seaman, Able B.			
4. NAME OR GRADE PCSN	5. SSN 777-77-7777	6. TITLE OF APPOINTEE MPC	
7. ORGANIZATION/ACTIVITY USS UNDERWAY (CV-66)		8. APO, MPO, OR CONUS INSTALLATION FPO AE 09561-0001	
9. MAIL AUTHORIZED TO RECEIVE <i>(Check and Initial)</i>		10. THIS FORM MUST BE VALIDATED BY THE SERV- ING AGENCY'S GENERAL PURPOSE DATING STAMP PRIOR TO CLERK RECEIVING MAIL. IN THE CASE OF THE NAVY MAIL ROOMS, VALIDATION MAY BE BY IMPRESSION OF THE UNIT'S OFFICIAL SEAL.	
<input checked="" type="checkbox"/> PERSONAL <i>(All)</i> ABS	<input type="checkbox"/> OFFICIAL <i>(Except accountable)</i>		
<input type="checkbox"/> PERSONAL <i>(Except accountable)</i>	<input type="checkbox"/> OFFICIAL POUCHES ONLY		
<input checked="" type="checkbox"/> OFFICIAL <i>(All)</i> ABS	<input type="checkbox"/>		
SIGNATURE OF APPOINTING OFFICIAL A. B. Smith		SIGNATURE OF APPOINTEE Able B. Seaman	

DD FORM 285 JUN 67 S/N 0102-LF-002-8201 EDITION OF THIS FORM NOT HAVING SSN IS OBSOLETE AFTER 30 JUNE 89 PCF0203

Figure 2-3.—An example of a DD Form 285.

## DESIGNATION OF MAIL ORDERLIES

A responsible official (division officer, department head, leading chief petty officer) normally designates mail orderlies for units or divisions requiring mail orderly service. These designations should be accomplished using a DD Form 285 (see figure 2-3) before personnel assume mail-handling duties. The number of designated mail orderlies should be held to the minimum number needed to efficiently and effectively handle the mail.

Division/section mail orderlies normally are charged only with safeguarding and delivery of incoming ordinary mail. Specific responsibilities of the mail orderly for a division/section include the following:

- Delivering personal mail to addressees only.
- Delivering official mail to individuals authorized by the commanding officer.
- Placing undeliverable mail in a suitable, securely locked container and delivering it later or returning it daily to the unit mailroom or serving post office, as applicable.
- Returning undeliverable mail to the unit mailroom or serving post office with the reason for non-delivery (TAD, leave, transferred, etc.).
- Reporting any known or suspected postal offenses and irregularities to the unit postal officer or commanding officer.

Before assuming mail-handling duties, mail orderlies must be properly trained. The training they receive should explain the importance of postal services, individual responsibilities, and the negative

consequences if they do not perform assigned postal duties according to established procedures and instructions. All ongoing training programs should include locally developed training courses as well as on-the-job training. A training program is required to meet the training criteria established by Department of Defense postal directives. For mail orderlies you should check blocks on the DD Form 285 that say, “Personal Except Accountable” and “Official Except Accountable.” For those mail orderlies that are authorized to screen accountable mail for classification purposes the “Official All” block will be checked.

After personnel are designated as mail orderlies, all copies of DD Form 285 must be validated by the serving postal activity. The validation must be done following the instructions in block 10 on the DD Form 285 (see figure 2-3). The validating officer may initial and date the form if activities do not possess an APDS or seal. Whichever method is used, uniformity should be maintained in validating all DD Form 285s at that activity. Three DD Form 285s must be completed and one form must be provided to each of the following:

- The mail orderly.
- The unit files.
- The serving postal activity.

In some cases DD Form 2260, Unit Mail Clerk/Orderly Designation Log is used instead of the unit file copy of DD Form 285; in which case, two copies of DD Form 285 should be completed. The purpose of DD Form 2260 is to provide a command or division with a record of names and DD Form 285 numbers in numerical sequence for assigned mail orderlies. Most large shore activities and shipboard divisions will normally maintain the DD Form 2260; however, it is not mandatory. When this form is used to record the appointments and revocations of mail orderlies, a file copy of DD Form 285 is not required to be maintained by the division or command. Figure 2-4 shows an example of a DD Form 2260. This log must be retained for 2 years after the last entry on the log has been revoked.

Mail orderlies must carry their DD Form 285 at all times while performing mail-handling duties, and they must present the form when receipting for mail.

## DESIGNATION OF CUSTODIAN OF POSTAL EFFECTS

In the first page of this chapter you learned about the selection and designation of Military Postal Clerks.



- Postage meter accounts (if postage meter equipment assigned); indicate current meter reading on reports and date and number of last meter report submitted. Postage meters and the forms required for meter operations will be discussed in chapter 8.
- Physically verify all capital and sensitive equipment listed on the command's PS Form 1590 (Supply and Equipment Receipt) and physically verifying the location of post office keys. This form will be covered in chapter 12.

Audit reports (DD Form 2259, Report of Audit of Postal Accounts) must be reviewed and signed by the auditing officers, both the incoming and outgoing COPEs, and the commanding officer. The incoming COPE must sign in the remarks section that he or she concurs with the results of the audit. Audits and DD Form 2259 will be covered in chapter 14.

The COPE and reserve custodian accounts must be exact. (NO TOLERANCE FOR THESE ACCOUNTS.) The outgoing COPE must replace any shortage in the COPE account; any overage must be submitted (by U.S. Treasury check or No-Fee money order) to the NPFO San Diego. Indicate in the remarks section of the audit report that the overage has been submitted, check number, and amount.

The incoming COPE must accomplish the following:

- Prepare PS Form 3369, Consigned Credit Receipt, in triplicate, for the command's assigned fixed credit. See figure 2-5.

- Change safe combinations. Put new combinations in sealed envelopes and give to the commanding officer or designated official; obtain a receipt on a modified PS Form 1096, Cash Receipt. See figure 2-6.
- Obtain receipt for post office keys not in the COPE's custody (see figure 2-7). The commanding officer or designated official must maintain duplicate keys in a sealed envelope, PS Form 3977, Duplicate Key Envelope (see figure 2-8).
- Prepare PS Form 1590 listing all capital and sensitive equipment verified during audit.

The incoming COPE will submit to NPFO San Diego the following:

- Original and 1 copy of PS Form 3369.
- Copy of COPE's designation, and outgoing COPE's termination on DD Form 2257.
- Any overages discovered during the audit (by U.S. Treasury check or No-Fee money order).
- Copy of COPE's and Reserve Custodian's audit reports (DD Form 2259).
- Original and 1 copy of PS Form 1590.

Figure 2-5 is an example of a PS Form 3369. Use instructions listed below to complete the form.

Block 1: Enter the name and rank of the person receiving the fixed credit.

Block 2: Enter the command's name and address.

Block 3: Check the applicable box.

Name <span style="float: right;">①</span>		Location of Credit <span style="float: right;">②</span>	
(Check One) <span style="float: right;">③</span> <input type="checkbox"/> Stamp Credit <input type="checkbox"/> Cash Credit		Credit Amount <span style="float: right;">④</span>	
		Max. Authorized Cash Portion <span style="float: right;">⑥</span>	
Issued by (Signature) <span style="float: right;">⑤</span>		Date	
I will faithfully account to the U.S. Postal Service for the consigned credit amount shown above or modified by transactions recorded on my Daily Financial Reports. I have read the following statements and have been advised of the priorities of protection to be given funds and accountable paper in Part 434.2-434.4, <i>Fiscal Handbook</i> , F-1, and Parts 213 and 220, <i>Fiscal Handbook</i> , F-50. Employees and contractors will be held responsible for losses of stamps and funds from stamp credits resulting from failure to give the best available protection during and after post office hours in accordance with Part 430, <i>Fiscal Handbook</i> , F-1. Withdrawal of official funds for personal use, whether temporary or permanent, may subject employees or contractors to removal from office, cancellation of contract, and criminal prosecution for violation of Title 18, Section 641 or 1711, U.S. Code.			
Signature <span style="float: right;">⑦</span>		Date <span style="float: right;">⑧</span>	

PS Form 3369, May 1987

CONSIGNED CREDIT RECEIPT

PCF0205

Figure 2-5.—An example of a Stamp Credit Receipt (PS Form 3369).

 <b>UNITED STATES POSTAL SERVICE®</b>		<b>Receipt</b>
Amount (Written Out)		Amount (In Numbers)
COMBINATION RECEIPT <del>100 Dollars</del>		\$XXXX
Purpose COPE'S COMBINATION TO SAFE		
Is any Portion of this Sale a Charitable Tax Deduction? <input type="checkbox"/> Yes <input checked="" type="checkbox"/> No		
If "Yes," the fair market value of the postage portion of the foregoing stamps equals the First-Class postage rate.		
By (Signature and Title) <i>Al B. Smith</i>		Date 15 OCT 2000
PS Form <b>1096</b> , April 1998		

PCf0206

Figure 2-6.—An example of a modified receipt for safe combinations (PS Form 1096).

 <b>UNITED STATES POSTAL SERVICE®</b>		<b>Receipt</b>
Amount (Written Out)		Amount (In Numbers)
KEYS RECEIPT <del>100 Dollars</del>		\$XXXXXX
Purpose KEY TO POST OFFICE		
Is any Portion of this Sale a Charitable Tax Deduction? <input type="checkbox"/> Yes <input checked="" type="checkbox"/> No		
If "Yes," the fair market value of the postage portion of the foregoing stamps equals the First-Class postage rate.		
By (Signature and Title) <i>Al B. Smith</i>		Date 15 OCT 2000
PS Form <b>1096</b> , April 1998		

PCf0207

Figure 2-7.—An example of a modified receipt for post office keys (PS Form 1096).

 <b>UNITED STATES POSTAL SERVICE®</b>		<b>Duplicate Key Inventory</b>	
Employee Name (Print Last, First, & MI) DOE, JOHN R.		<b>Instructions</b> <b>See Section 362, Handbook F-1, Post Office Accounting Procedures</b> After the duplicate keys are enclosed and the flap is sealed, both you (the employee to whom the keys are assigned) and the witness to the sealing of this envelope must sign across both flaps on the reverse of this envelope. Affix a distinct and legible postmark across both envelope flaps. Give this signed and postmarked envelope to the appropriate supervisor who will be personally responsible for its protection.  If it is necessary for you to withdraw keys temporarily, open this envelope in the presence of a witness. Cut along one end, leaving the signatures and postmarks intact. Both you and the witness must endorse and date the envelope. When the keys are returned, discard the opened envelope and prepare a new envelope.  If access to one of your locked receptacles is necessary while you are absent from duty, the appropriate supervisor will remove the key from this envelope in the presence of a designated witness and both will endorse and date this envelope and show reason for withdrawing the key. The supervisor (or designee) and the witness must inventory the contents of the receptacle and certify the inventory. The supervisor must maintain the inventory with the opened envelope.	
Operating Unit COPE, POST OFFICE			
<b>Receptacle</b>	<b>No.</b>	<b>No. Keys</b>	<b>Serial No.</b>
Cash Drawer	XXXXX	XXXX	XXXXXXXXXX
	XXXXX	XXXX	XXXXXXXXXX
Stamp Cabinet	XXXXX	XXXX	XXXXXXXXXX
Safe Compartment	XXXXX	XXXX	XXXXXXXXXX
Envelope Drawer	XXXXX	XXXX	XXXXXXXXXX
POST OFFICE	XXXXX	2	XXXXXXXXXX
Designated Witness Name (Print)			
Designated Witness Name (Print)			
PS Form <b>3977</b> , April 1988			

PCf0208

Figure 2-8.—An example of a duplicate key envelope (PS Form 3977).

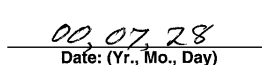
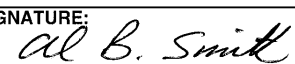
DESIGNATION/TERMINATION MPC-FPC-COPE-PFO		
TO: (Use complete address) ABLE B. SEAMAN USS UNDERWAY (CV-66) FPO AE 09561-0001	FROM: (Use complete address) COMMANDING OFFICER USS UNDERWAY (CV-66) FPO AE 09561-0001	
<b>DESIGNATION</b>		
THE INDIVIDUAL NAMED BELOW IS DESIGNATED:		
TEMPORARY COPE FOR THE PERIOD OF 28 JULY 00 THRU 18 AUGUST 00	<input type="checkbox"/> MILITARY POSTAL CLERK (MILITARY) <input type="checkbox"/> FINANCIAL POSTAL CLERK (CIVILIAN) <input checked="" type="checkbox"/> CUSTODIAN OF POSTAL EFFECTS <input type="checkbox"/> POSTAL FINANCE OFFICER	
NAME: (Last, First, MI) (Typed or printed) SEAMAN, ABLE B.	PAY GRADE: E-3 (PCSN)	BRANCH OF SERVICE: U.S. NAVY
ACTIVITY FOR WHICH DESIGNATED: USS UNDERWAY (CV-66)		
I acknowledge my designation as shown above, and shall faithfully discharge the duties associated with this designation. I also agree to obey all laws and regulations established by the United States Postal Service and the Department of Defense.		
 Signature of Designee		 Date: (Yr., Mo., Day)
TYPED/PRINTED NAME OF DESIGNATING OFFICIAL: (Last, First, MI) SMITH, AL B.	PAY GRADE O-3	SIGNATURE:  DUTY TITLE: POSTAL OFFICER
<b>TERMINATION</b>		
THE ABOVE DESIGNATION IS TERMINATED EFFECTIVE (Yr, Mo, Day):		
REASON FOR TERMINATION (EXPLAIN IN DETAIL):		
TYPED/PRINTED NAME OF TERMINATING OFFICIAL: (Last, First, MI)	PAY GRADE	SIGNATURE:  DUTY TITLE:

DD Form 2257, JAN 82 (EG)

Replaces AF Form 1948, Aug 76, which is obsolete.

Designed using Perform Pro, WHS/DIOR, Mar 95  
PCF0209

Figure 2-9.—An example of a completed DD Form 2257 designating temporary COPE.

Block 4: Indicate the amount of the fixed credit being issued.

Block 5: Leave blank for NPFO San Diego signature. If COPE were issuing stock to window clerk, COPE would sign this block.

Block 6: Indicate the maximum amount of cash that can be retained in the fixed credit. This must be 25% of the total amount of the fixed credit.

Block 7: Signature of the person receiving the fixed credit.

Block 8: The date the person received the fixed credit.

### DESIGNATION OF TEMPORARY COPE

In case of a temporary absence of the COPE (over 5 consecutive working days, but less than 31 total days), designate another qualified person, using DD Form 2257, as a temporary COPE (see figure 2-9). Transfer the required quantities of accountable paper, funds, money orders, and equipment to the temporary COPE to operate the post office during the COPE's absence. Exchange PS Form 3369 for stamps and



funds, DD Form 885 for money orders, and PS Form 1590 for capital and sensitive equipment between the two members. Retain the original copy of the temporary COPE designation in the activity's file and provide one copy to the designee. Upon return of the COPE, terminate the temporary designation and exchange PS Form 3369, DD Form 885, and PS Form 1590. File the terminated temporary COPE designation in the MPO files.

### DESIGNATION OF POSTAL OFFICER

Commanding officers afloat and ashore are responsible for designating in writing a commissioned or warrant officer or, when practicable, a Chief Postal Clerk as the postal officer for the command (see figure 2-10). The postal officer is responsible to the

commanding officer for the overall supervision of postal functions of the command.

### DESIGNATION OF RESERVE CUSTODIAN FOR BULK STAMP STOCK, BLANK MONEY ORDER FORMS, AND MONEY ORDER AUDIT AND VERIFICATION OFFICER

Commanding officers afloat and ashore are responsible for designating in writing a commissioned or warrant officer or a Chief Postal Clerk when one is assigned as reserve custodian of bulk stamp stock, blank money order forms and money order audit and verification officer (see figure 2-11). The designated official will be responsible for performing the duties outlined in *OPNAVINST* 5112.6 chapter 1.

/COMMAND LETTER HEAD/	
	SER 5110 Date:
From:	Commanding Officer, USS Underway
To:	LT A. B. Smith, SC, USN, 111-11-1111/3100
Subj:	DESIGNATION AS POSTAL OFFICER
Ref:	(a) OPNAVINST 5112.6 (b) DOD 4525.6M, Vol. I & II
<p>1. In accordance with reference (a), you are hereby designated as the Postal Officer for USS Underway. You are tasked with the detailed supervision of the ship's post office and all postal operations. You shall familiarize yourself with the provisions of references (a) and (b) and be guided by them in the performance of your duties.</p> <p>2. This designation remains in effect until properly relieved.</p>	
	/s/ W. T. Door
Copy to:	
Service Record	
Post office files	

Figure 2-10.—Sample of a postal officer designation letter.

/COMMAND LETTER HEAD/

SER 5110

Date:

From: Commanding Officer, USS Underway  
To: ENS Jane B. Doe, SC, USN, 222-22-2222/3100

Subj: DESIGNATION AS RESERVE STAMP CUSTODIAN, BLANK MONEY ORDER  
FORMS CUSTODIAN, AND DAILY MONEY ORDER AUDIT AND VERIFICATION  
OFFICER

Ref: (a) OPNAVINST 5112.6  
(b) DOD 4525.6M Vol. I

1. In accordance with references (a) and (b), you are hereby designated as the Reserve Stamp Stock Custodian, Blank Money Order Forms Custodian and Daily Money Order Audit and Verification Officer. Reserve stamp stock and money order accounts will be administered in accordance with reference (b).
2. Blank money order forms will be retained in your custody. Postal clerks are not authorized to retain blank money order forms overnight; therefore, money orders will be checked out and in each business day.
3. You will conduct an audit and review of the daily money order report. Cash revenue obtained through the sales of postal money orders will be turned in daily for an ex-cash remit U.S. Treasury check made payable to the Disbursing Officer, U. S. Postal Service.

/s/

W.T. Door

Copy to:  
Service Record  
Post office files

Figure 2-11.—Sample of a reserve custodian designation letter.

**DESIGNATION OF MONIES AUDIT  
BOARD MEMBERS**

Commanding officers afloat and ashore are responsible for ensuring that postal effects assigned to their commands are audited on a monthly basis with quarterly audit reports being submitted to the NPFO

San Diego. These audits are conducted by personnel designated in writing (see figure 2-12).

*Q2-1. What two publications govern the completion of DD Form 2257 and the preparation of page 13 entries?*

/COMMAND LETTER HEAD/

SER 5110

Date:

From: Commanding Officer, USS Underway  
To: ENS P. T. Boate, USN, 123-45-6789/1310

Subj: APPOINTMENT TO MONIES AUDIT BOARD

Ref: (a) OPNAVINST 3120.32B  
(b) DOD 4525.6M, Vol. I  
(c) OPNAVINST 5112.6

1. In accordance with reference (a), you are hereby appointed to the monies audit board for USS Underway.
2. Two or more monies audit board members will conduct random “surprise” audits, variably spaced throughout the month. Auditors will use DD Form 2259 to document their findings. Current instructions for auditing Navy post offices are contained in references (b) and (c).
3. This appointment remains in effect until properly relieved.

/s/

W. T. Door

Copy to:  
Service Record  
Post office files  
Postal Officer

Figure 2-12.—Sample of a monies audit board designation letter.

- |   |   |
|---|---|
| <p>Q2-2. <i>When is it necessary to make a page 13 entry into your service record designating you as a military postal clerk and for what length of time will the designation continue to remain in effect?</i></p> | <p>Q2-7. <i>Before assuming the duties as a COPE for a fixed credit account, what designation must your command complete?</i></p> |
| <p>Q2-3. <i>What DD Form is used to designate mail orderlies?</i></p>   | <p>Q2-8. <i>How long can a COPE be away from the command before a temporary COPE is designated?</i></p>                           |
| <p>Q2-4. <i>Before assuming mail-handling duties, mail orderlies must meet what requirements?</i></p>   | <p>Q2-9. <i>What is the lowest ranking person a commanding officer can designate as postal officer?</i></p>                       |
| <p>Q2-5. <i>What is the purpose of DD Form 2260?</i></p>  | <p>Q2-10. <i>What individual(s) maintain(s) the portion of fixed credit not in the COPE's possession?</i></p>                     |
| <p>Q2-6. <i>How long must the DD Form 2260 be kept on file?</i></p>   |   |

*Q2-11. Monthly audits of the command's fixed credit account are conducted by what command organization?*

Now turn to appendix 1 to check your answers.

## **TERMINATION OF MILITARY POST OFFICE PERSONNEL DESIGNATIONS**

---

**Learning Objective:** *Recall the procedures for removing designations of military post office personnel.*

---

The termination of MPO personnel designations is required for a wide variety of reasons. The type of designation and reason for a person's removal from postal duties also determines the process required for completing the termination. We will discuss some of the reasons for terminating designations and the procedures for completing the termination forms in the following paragraphs.

### **TERMINATION OF MPC DESIGNATION**

As we discussed at the beginning of this chapter, a military postal clerk's designation remains in effect during their entire career. Below are some reasons for terminating MPC designations:

- Discharge from military service.
- Change of rating.
- Convicted of a crime, such as theft or an offense of moral turpitude.
- Relieved from postal duties for cause, for example, loss of postal effects through fraud or intent to defraud, negligence, mismanagement, or other serious irregularities.
- Consistent overages or shortages in account audits in excess of tolerance.
- Failure by the member to show required progress in training programs established by their military service or command.

Procedures, authority for, and distribution of termination actions are the same as for designations. The original DD Form 2257 is maintained in the MPO files for 2 years from the termination date (see figure

2-13), and the member's DD Form 285 must be voided, and maintained on file for two years (see figure 2-14).

Military or civilian personnel, who are relieved for negative reasons provided in paragraph 1 above, will not be considered eligible for further postal assignments or positions. Commanders relieving such personnel from postal duties must coordinate this action with personnel offices to ensure personnel records are properly annotated to prevent reassignment to postal duties.

A person whose designation is terminated must cease all postal duties by the effective date of revocation.

### **TERMINATION OF COPE DESIGNATION**

When it becomes necessary to terminate a COPE's designation (relief is present), the termination procedures are the same as the procedures for designating a new COPE.



If it becomes necessary to terminate a COPE's designation and no qualified relief is immediately available to continue operation of the post office, the postal effects and funds must be placed in the custody of a commissioned or warrant officer designated by the responsible commander (normally the reserve custodian). In addition, operations should be suspended until a designated replacement is on board. If possible, give the COPE being relieved receipts to document the transfer. DOD 4525.6M Volume I, chapter 1, explains procedures for suspending operation of an MPO.

Figure 2-13 illustrates a termination on a DD Form 2257. Use instructions listed below to complete the process.

- Block 1. Enter the date the designation is terminated.
- Block 2. Enter the reason for termination and effective date.
- Block 3. Type or print name of terminating official.
- Block 4. Enter the terminating official's paygrade.
- Block 5. Signature of terminating official.
- Block 6. Enter the terminating official's duty title.

### **TERMINATION OF MAIL ORDERLY'S DESIGNATION**

When it becomes necessary to terminate a mail orderly's designation (transfer, dereliction of duties,

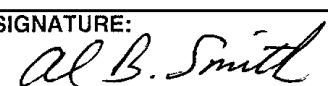
DESIGNATION/TERMINATION MPC-FPC-COPE-PFO		
<b>TO: (Use complete address)</b> NAVY POSTAL FINANCE OFFICE 4070 SURFACE NAVY BLVD STE 3 SAN DIEGO CA 92136-5287	<b>FROM: (Use complete address)</b> COMMANDING OFFICER USS UNDERWAY (CV-66) FPO AE 09561-0001	
<b>DESIGNATION</b>		
THE INDIVIDUAL NAMED BELOW IS DESIGNATED:		
<input type="checkbox"/> MILITARY POSTAL CLERK (MILITARY) <input type="checkbox"/> FINANCIAL POSTAL CLERK (CIVILIAN) <input checked="" type="checkbox"/> CUSTODIAN OF POSTAL EFFECTS <input type="checkbox"/> POSTAL FINANCE OFFICER		
<b>NAME: (Last, First, MI) (Typed or printed)</b> DOE, JOHN R.	<b>PAY GRADE:</b> E-6 (PC1)	<b>BRANCH OF SERVICE:</b> U.S.NAVY
<b>ACTIVITY FOR WHICH DESIGNATED:</b> USS UNDERWAY (CV-66)		
I acknowledge my designation as shown above, and shall faithfully discharge the duties associated with this designation. I also agree to obey all laws and regulations established by the United States Postal Service and the Department of Defense.		
 Signature of Designee		<u>97, 10, 15</u> Date: (Yr., Mo., Day)
<b>TYPED/PRINTED NAME OF DESIGNATING OFFICIAL: (Last, First, MI)</b> SMITH, AL B.	<b>PAY GRADE</b> 0-3	<b>SIGNATURE:</b>  <b>DUTY TITLE:</b> POSTAL OFFICER
<b>TERMINATION</b>		
<b>THE ABOVE DESIGNATION IS TERMINATED EFFECTIVE (Yr, Mo, Day):</b> 00, 12, 31 <span style="float: right;">①</span>		
<b>REASON FOR TERMINATION (EXPLAIN IN DETAIL):</b>		
MEMBER TRANSFERRING FROM USS UNDERWAY ON 00 DEC 31. <span style="float: right;">②</span>		
<b>TYPED/PRINTED NAME OF TERMINATING OFFICIAL: (Last, First, MI)</b> SMITH, AL B. <span style="float: right;">③</span>	<b>PAY GRADE</b> 0-3 <span style="float: right;">④</span>	<b>SIGNATURE:</b>  <span style="float: right;">⑤</span> <b>DUTY TITLE:</b> POSTAL OFFICER <span style="float: right;">⑥</span>

DD Form 2257, JAN 82 (EG)

Replaces AF Form 1948, Aug 76, which is obsolete.

Designed using Perform Pro, WHS/DIOR, Mar 95

PCf0213

Figure 2-13.—DD Form 2257, Termination of COPE Designation.

APPOINTMENT OF MILITARY POSTAL CLERK, UNIT MAIL CLERK OR MAIL ORDERLY <i>(See Instructions on Reverse)</i>		1. DATE EFFECTIVE 99/06/23	2. DATE REVOKED 00/01/16
3. NAME OF APPOINTEE (Last, First, Middle Initial) BRUSH, FLOSS A.			
4. NAME OR GRADE SKSN	5. SSN 999-99-9999	6. TITLE OF APPOINTEE MAIL ORDERLY	
7. ORGANIZATION/ACTIVITY SUPPLY DEPT		8. APO, MPO, OR CONUS INSTALLATION FPO AE 09561-0001	
9. MAIL AUTHORIZATION RECEIVE (Check one) <input checked="" type="checkbox"/> PERSONAL (All) ABS <input type="checkbox"/> PERSONAL (Except accountable) <input type="checkbox"/> OFFICIAL (Except accountable) <input type="checkbox"/> OFFICIAL FOUCHES ONLY		10. THIS FORM MUST BE VALIDATED BY THE SERVING AGENCY'S DESK OFFICER PRIOR TO CLERK RECEIVING MAIL. IN THE CASE OF THE NAVY, VALIDATION MAY BE BY IMPRESSION OF THE DESK OFFICIAL SEAL.	
SIGNATURE OF APPOINTING OFFICIAL <i>Al B. Smith</i>		SIGNATURE OF APPOINTEE <i>Floss A. Brush</i>	
DD FORM 285 JUN 87 S/N 0102-LF-002-9201 EDITION OF THIS FORM NOT HAVING SSN IS OBSOLETE AFTER 30 JUNE 99 PCI0214			

Figure 2-14.—Sample of a withdrawn and voided DD Form 285.

or for other reasons), the division officer or other designating official should revoke the member’s DD Form 285. The official should place the date in block 2, draw a diagonal line through the card, and write void or revoked above it (see figure 2-14). After this has been completed, the division or serving postal facility that holds the DD Form 2260 (figure 2-4) (if used) must document the date revoked block with the same date shown in block 2 of the DD Form 285.

- Q2-12. How long must a DD Form 2257 terminating an MPC’s designation be retained in the MPO files?
- Q2-13. When terminating a COPE’s designation and no qualified relief is present, who should take custody of the command’s postal effects?
- Q2-14. What form must be revoked when removing a mail orderly’s designation?

Now turn to appendix 1 to check your answers.

## CHAPTER 3

# MAIL PACKAGING AND ACCEPTANCE

Before any article may be accepted for mailing, it must meet certain packaging and wrapping requirements. The DMM contains these requirements. Check each article you receive at the postal finance window for proper packaging and wrapping. Examine each article's outside wrapping. If you believe the package will become unwrapped in the mail, advise the customer that the package is not acceptable and discuss correct wrapping procedures. Be as helpful and courteous as possible.

As a window clerk, you will also need to know how to operate certain equipment and how to conduct window transactions. This chapter will provide general information in this regard.

### MAIL PREPARATION

---

**Learning Objective:** *Identify the packaging procedures involved in mail preparation.*

---

Proper packaging is the key that guards against damaged mail. No item should be packaged so that its contents may harm mail-handling personnel, equipment, or other mail. Through proper packaging the mailer is responsible for providing protection against damage to articles under normal handling while the articles are in the custody of the U.S. Postal Service (USPS) and the military postal system. The mailer should consider the type of item that is to be mailed, the transit time, the extent to which the item will be handled, and the method(s) of transportation.

You, as a military postal clerk, are not authorized to assist the mailer in preparing articles for mailing. However, you should be able to advise the mailer of the best type of container to use, the type of cushioning that may be required, and the proper method to seal the container. Additional information on mail preparation is found in the DMM.

### TYPES OF LOADS

---

**Learning Objective:** *Recognize the types of loads used in the transportation of mail.*

---

Three types of loads used in the transportation industry are recognized by the USPS. The contents, type, and strength of the container determine these loads.

#### EASY LOAD

Items of moderate weight that completely fill the container are known as an *easy load*. Puncture or shock (dropping or movement) does not readily damage easy loads. They do not shift or otherwise move within the package or present a hazard to other mail.

#### AVERAGE LOAD

An *average load* is when several items are packaged directly into a shipping container and provide partial support to all its surfaces. Average loads may also be prepackaged by nesting items within partitions or in separate paperboard boxes (such as a set of glasses) as shown in figure 3-1. This tends to prevent the items from shifting and causing damage to them and the container.

#### DIFFICULT LOAD

The term, *difficult load*, is applied to items that require a high degree of protection from puncture, shock, or distortion. These include fragile items, delicate instruments, and heavy and small bulk items. These items do not support the mailing container and are not acceptable in paperboard boxes, bags, or wraps of any type.

#### ACCEPTABLE CONTAINERS

---

**Learning Objective:** *Determine the types of containers authorized for use in the mail system.*

---

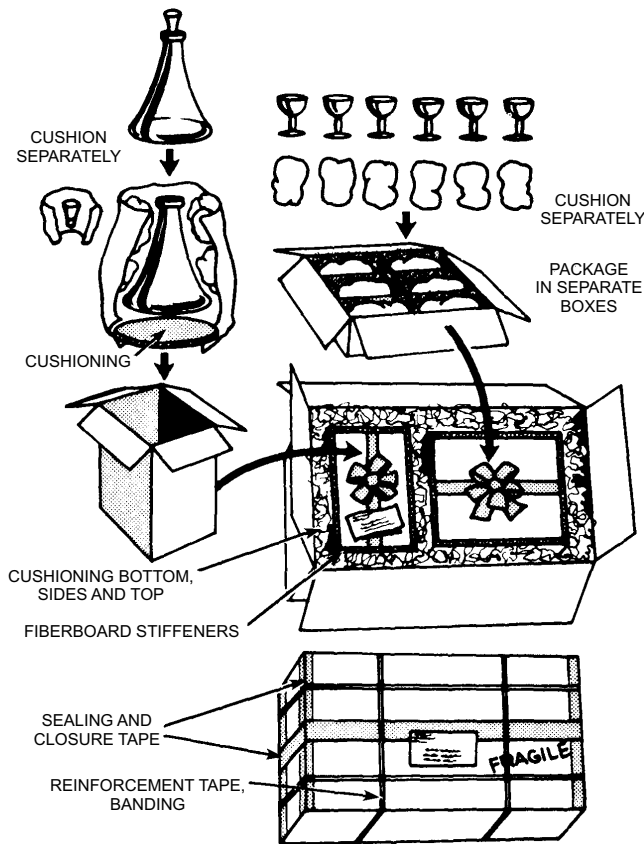

PCf0301

**Figure 3-1.—Cushioning fragile items for mailing.**

An essential requirement for proper packaging is an acceptable container. Acceptable containers include corrugated or solid fiberboard, chipboard (for small items), metal cans, tubes or boxes, wooden boxes or crates, fiber mailing tubes with metal ends, and envelopes. The criteria for acceptability depends on

the container’s ability (strength) to retain and protect contents during normal mail handling. Although the responsibility for proper packaging of an article rests with the customer, the clerk must be the judge of its acceptability. Be sure you understand how to check an article for proper packaging and wrapping.

**BOXES**

Paperboard boxes, similar to suit boxes, are acceptable for easy and average loads up to 10 pounds. Metal-stayed paperboard boxes are acceptable for easy and average loads up to 20 pounds. Solid and corrugated fiberboard boxes are acceptable for easy and average loads up to the weight limits shown in table 3-1.

As you can see, an average load weighing up to 20 pounds requires a fiberboard box with a test burst strength of 125 pounds. For a difficult load a fiberboard box with test burst strength of 175 pounds is required for a 20-pound load. Normally, the test burst strength of a fiberboard box is indicated on the box somewhere in the area as shown in figure 3-2.

**PACKAGE SURFACES**

Package surfaces that will not retain an adhesive stamp, postage meter impression, or ballpoint pen or pencil marking are not acceptable. Address labels, and particularly envelopes, should be firmly sealed to containers. Mailings with labels and envelopes that do not meet this requirement may be rejected if they cause problems in processing.

**Table 3-1.—Fiberboard box test strengths used in selecting a container for mailing.**

Maximum		Length and Girth (inches)	Box Grade
Weight of Box and Content (pounds)			
Easy or Average Load	Difficult Load		
20	—	67	125
40	20	100	175
65	45	108	200
70	65	108	275
—	70	108	350



## Select the Proper Container

Fiberboard containers are generally strong enough to ship material of average weight and size. These are the common boxes which are readily available in the home, supermarket, hardware store, etc. An "average" parcel may be defined as one which is no more than 34" X 17" X 15" and weighs 25 pounds or less. These are the dimensions normally associated with automated parcel processing.

Fiberboard strength is indicated on the box, manufacturer's strength certification printed on the bottom of the box. This certification is usually a round imprint with four numbers noted.

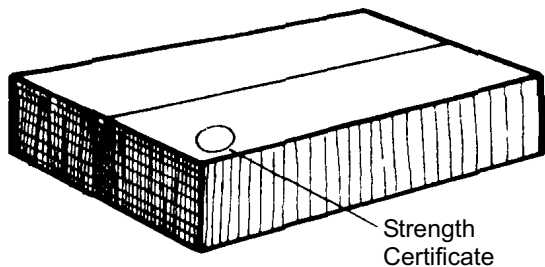

PCf0302

Figure 3-2.—Test burst strength shown on a fiberboard box.

### OUTSIDE WRAPS FOR BOXES

Wrapping paper equivalent to the strength of the average grocery bag may be used to wrap parcels. (Wrapping paper is not required, nor recommended by the USPS, if the box itself is an adequate shipping container.)

### ENVELOPES

Envelopes may be used as containers for articles when they can reasonably be expected to be handled and delivered without damage to the contents or other mail. Letter-style envelopes are flat envelopes that meet the minimum and maximum size requirements. Envelopes of this type are not reinforced and are acceptable as containers for nonrigid stationery and material of a similar nature that does not exceed 1 pound in weight and 1 inch in thickness. Envelopes exceeding the size for letter style and made from extra-strength materials are acceptable for easy loads up to 5 pounds.

### FIBERBOARD TUBES AND LONG PACKAGES

Fiberboard tubes and similar long packages are acceptable provided their length is not more than 10 times the girth (diameter) of the article. Tubes are ideal for mailing rolled items such as unframed paintings, documents, fishing rods, and so forth. If the tube is of the two-piece type, where one end slides into the other, tape must be applied to completely encircle the seams where the two pieces are joined. The ends of tubes may be closed by crimping or with tape only if the contents are rolled lightweight items. Otherwise, the ends should be closed with a material as strong as that of which the tube is made.

### CANS AND DRUMS

Cans and drums are acceptable if they have positive closures (the top screws on, is secured by bolts, clamps, and so forth). Generally, friction closures by themselves are not acceptable. Devices that are closed with locking rings that stick out must be padded to prevent injury to mail-handling personnel, equipment, or other mail. Cans and drums should not be sacked or pouched regardless of their weight. They must be dispatched as outside mail (OSM) to make sure that equipment or postal personnel are not injured.

- Q3-1. *What are the three types of packaging loads used in the transportation industry that are recognized by the USPS?*
- Q3-2. *An average load, as defined, weighing 20 pounds requires a fiberboard box of what burst strength?*
- Q3-3. *Packages with surfaces that will not retain an adhesive postage meter impression are not acceptable for mailing. (True/False)*
- Q3-4. *Paper wrappers should not be used when a parcel (box type) is mailed if what circumstance exists?*
- Q3-5. *Fiberboard tubes and similar long packages are acceptable for mailing provided their length does not exceed what amount of the girth (diameter)?*
- Q3-6. *What type of closure must a metal can or drum have to be accepted for mailing at a military post office?*

Now turn to appendix 1 to check your answers.

## CUSHIONING

---

**Learning Objective:** *Identify the types of cushioning materials used in the preparation of mailing containers.*

---

Cushioning absorbs and distributes forces caused by shock and vibration. Examples of acceptable cushioning materials are as follows:

- Foamed plastics
- Rubberized hair
- Corrugated fiberboard
- Excelsior (wood shavings)
- Shredded newspaper

Figure 3-1 shows the proper method of using cushioning material.

If loose fill cushioning (excelsior, shredded newspapers, and so forth) is used, it must overfill the container before it is closed. This is to prevent movement of the enclosed items to an outside surface of the container or between any other items in the package.

## CLOSURES

---

**Learning Objective:** *Identify the authorized closing and reinforcement materials used for securing mailing containers and approved outer markings.*

---

The closing and reinforcement of a package should be carefully checked at the time it is presented for mailing. The most common types of materials used for closure and reinforcement of packages are as follows:

- Gummed tape
- Pressure-sensitive tape
- Adhesives (cement, glue, and so forth)
- Strapping (twine, cord, metal bands, and so forth)

## TAPE

Tape, other than cellophane and masking, can be used for closing, sealing, and reinforcing fiberboard containers. Cellophane and masking tape should only be used to augment adhesive closures on envelopes or to cover staples on bags. It is recommended that pressure-sensitive tape or filament-reinforced tape be used for closing and sealing of containers.

### Paper Tape

Paper tape is widely used for closing and sealing, but is not adequate for reinforcement. If paper tape is used, it must be at least a 60-pound basic weight kraft. Reinforced kraft paper tape should be used if reinforcement of a container is required. It is more durable than plain kraft tape and takes less time and tape for an equal closure.

### Pressure-Sensitive Tapes

Pressure-sensitive tapes come with various paper, cloth, or plastic backings, both plain and reinforced. They may be readily applied on a clean surface at any temperature above freezing. Pressure-sensitive tape should be used on containers in the same way as gummed tape. Figure 3-3 shows the proper application of tapes. Except for pressure-sensitive filament tape, tapes used for closure and reinforcement should be at least 2 inches wide.

## ADHESIVES

Adhesives for closure on box flaps or on tapes must remain serviceable from -20 degrees to +160 degrees Fahrenheit. Hot melt adhesive may be used if at least four strips are applied on each box flap where the outer flap overlays the inner flap; each strip is 3/16 inch wide after compression; the strips are not more than 1-1/2 inches apart, with the first strip no more than 1/2 inch from the center seam; and all strips are the full width of the inner flap, unless hot-melt adhesive is applied to 25% of the area where the outer flap lies over the inner flap.

## BANDING

If banding is used for closure and reinforcement, it should encircle the length and girth of the package at least once. Although not preferred, twine and cord may be used as reinforcement. You should not encourage customers to use twine or cord as this type

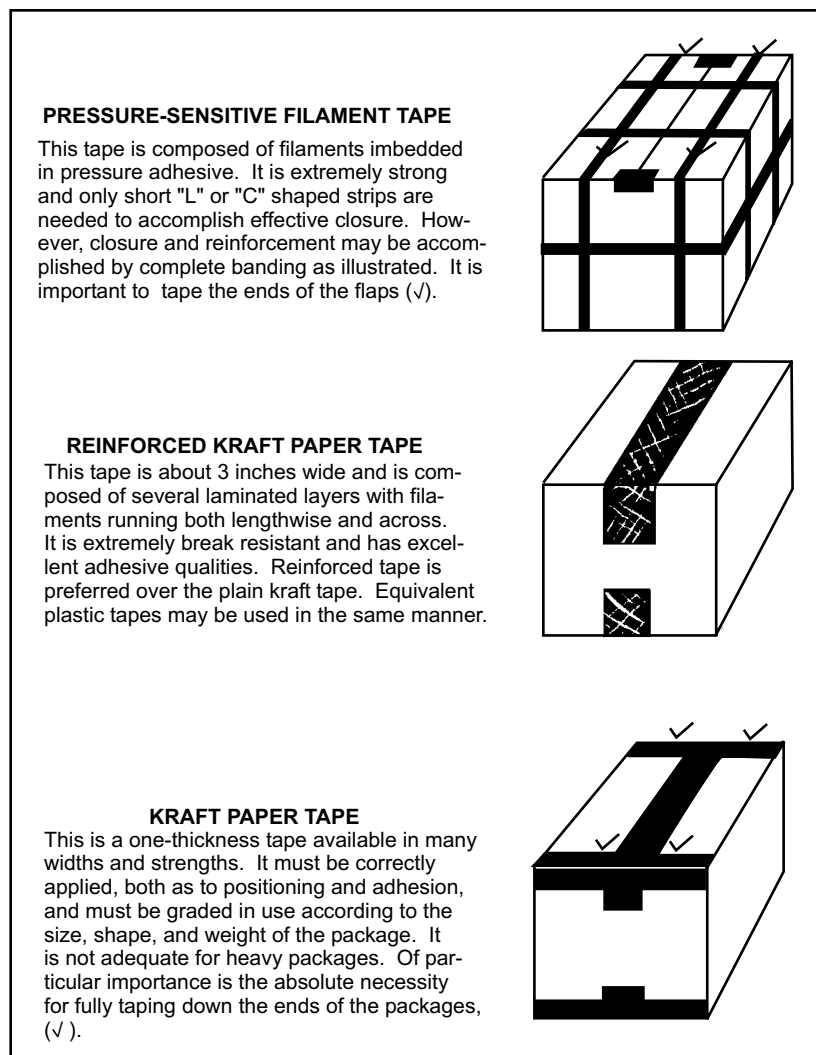

PCF0303

Figure 3-3.—Closing a parcel with tape.

of reinforcement can get caught in mail-processing equipment. If twine or cord is used, it should be at least 20-pound stress strength. Loose strapping, especially metal, is not acceptable because it may be a hazard to mail-handling personnel and equipment. If metal strapping is used, it should have smooth or plastic-coated edges.

### STAPLING

Closing of containers with staples and steel stitching is acceptable if the following methods are used:

Easy and average loads—staples are spaced no more than 5 inches apart.

Difficult loads—staples are spaced no more than 2 1/2 inches apart.

Staples for all loads should not be more than 1 1/4 inches from the ends of the box.

### MARKINGS

Markings by the mailer must be of a material that is not readily water-soluble or can easily be rubbed off or smeared. Customers should be encouraged to mark the address and return address directly on the package. The markings must be sharp and clear at a distance of 30 inches. It is recommended that the address also be inserted inside the parcel to aid in delivery if the address on the package becomes unreadable.

### Special Markings

Table 3-2 lists the wording that may be used for marking and labeling envelopes and packages by postal customers. Markings or endorsements, when

**Table 3-2.—Markings that may be placed on articles by customers**

MARKINGS AND ENDORSEMENTS FOR MAIL CONTAINERS BY CUSTOMERS		
Marking	Applicable To Items	Marking is Mandatory
Fragile	Containing delicate items such as glass, and electrical appliances.	Yes
Perishable		
DO NOT BEND	Only when contents of container is fully protected with stiffening material.	No
DO NOT FOLD		
DO NOT CRUSH		
Return Receipt Requested	Must use the wording or label required by the special service standard.	Yes
Special Handling		

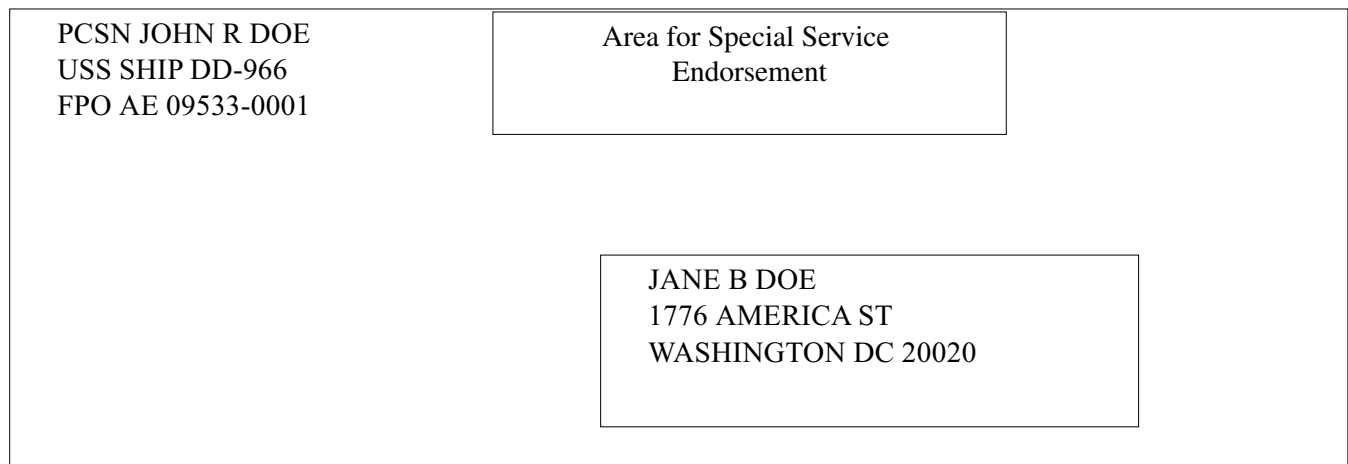

**Figure 3-4.—Area for placement of special service endorsement.**

used, should be placed in an area above the address (figure 3-4).

**Unauthorized Markings**

Unauthorized markings are markings that do not designate the rate of postage, class of mail, mailing address, handling instructions, content, or the special service requested. Unauthorized markings are not permitted to appear on articles presented for mailing. Obsolete markings should be covered or obliterated. Containers improperly identified as to content are not acceptable (for example, a box marked as containing cornflakes that actually contains flammable liquids). Imitations of postage stamps, in adhesive or printed form, or private seals or stickers that are like a postage

stamp in form and design should not be placed on parcels accepted for mailing. Decorative markings and designs, in adhesive or printed form, that imitate the markings and designs used to identify official postal services (see figure 3-5) should not be placed on



PCF0305

**Figure 3-5.—Examples of labels that may not be placed on articles to be mailed.**

parcels accepted for mailing. Extraneous information such as order numbers, which can be confused with ZIP Codes, are not permitted next to or immediately under the last line of the address.

- Q3-7. *Name at least four types of acceptable cushioning materials that may be used when a parcel is prepared for mailing.*
- Q3-8. *What two types of tape are NOT acceptable for the reinforcement or the closure of packages?*
- Q3-9. *What type of tape is widely used for closing and sealing packages, but is not adequate for reinforcement?*
- Q3-10. *What is the requirement of metal straps if metal strapping is used for closing or the reinforcement of packages?*
- Q3-11. *When an easy or average load parcel is prepared for mailing, staples may be used provided the staples are spaced at least what maximum distance apart?*
- Q3-12. *At what maximum distance should markings on packages be clearly seen by postal personnel?*

Now turn to appendix 1 to check your answers.

## THE ZIP CODE SYSTEM

---

**Learning Objective:** *Learn the breakdown and assignment of ZIP Codes.*

---

Earlier in chapter 1 we discussed the *National Five-Digit ZIP Code and Post Office Directory*. Now let's take a look at the ZIP Code system and what it means to the Military Postal Service.

ZIP Codes enable the USPS to achieve greater accuracy, speed, and economy in the processing and delivery of mail. As a military postal clerk, you can do your customers a service by encouraging them to use their correct ZIP Code in the return address of all mail. If a ZIP Code is used as a part of the return address, the person(s) to whom they are writing will have their correct ZIP Code when replying. ZIP coded mail can be processed quickly by automated equipment, whereas all non-ZIP coded mail must be processed

manually upon initial entry into the USPS channels. If the mail is ZIP coded, the result is fewer handlings and faster, more accurate delivery. Thus, using ZIP Codes provides your customers with better service.

## ZIP CODE DESCRIPTION

The ZIP (zone improvement plan) Code is a numerical code that identifies areas within the United States and its territories for purposes of simplifying the distribution of mail by both the military and USPS. The first digit of the ZIP Code divides the country into 10 large groups of states numbered from 0 in the North East to 9 in the Far West. Within these areas, each state is divided into an average of 10 smaller geographic areas identified by the second and third digits of the ZIP Code. The fourth and fifth digits identify a local delivery area. The four-digit add-on enables a further sortation within the local delivery office. The first two digits of the four-digit add-on denote a delivery sector for the mail carrier that will make the actual delivery. This sector may be several blocks, a group of streets, several office buildings, or even a small geographic area. The last two digits of the four-digit add-on denotes a delivery segment that might be one floor of an office building, one side of street, a firm, a suite, a post office box, a group of boxes, or other specific geographic location. See figures 3-6 and 3-7 for examples of a breakdown of a ZIP Code.

## SHIPS' ZIP CODES

All ships are assigned their own unique ZIP + 4 code. This ZIP code policy includes the following ships:

U.S. Navy ships, both active and reserve

U.S. Coast Guard

Military Sealift Command

National Oceanic and Atmospheric Administration

Ships are assigned ZIP Codes based on their number of crewmembers and/or their geographic location.

All ships receive their mail through one of three gateways. Their assigned FPO address depends on the homeport of the ship. Ships homeported on the East Coast (Atlantic Fleet) are assigned an FPO address of AE (Europe) or AA (Americas), with Charleston, SC, as the dividing point. All ships homeported south of Charleston, SC are assigned an FPO AA address. All



though the primary first five digits are the same for each geographical area, the last four will be unique. Current addresses for all U.S. Navy mobile units can be found in the SNDL, part 1.

## FORMS OF ADDRESSES

---

**Learning Objective:** *Identify proper addresses and address placement.*

---

Incorrect and incomplete addresses are the most common cause of delay or nondelivery of mail. All articles presented for mailing must contain a complete return and delivery address (see Module A of the DMM for specifics). All addresses must be clear, legible, and placed on one side only of each article accepted for mailing. Senders must place the return address on the upper left corner of the article. The delivery address is placed on the center of the article. A clear space must be available on all mail for the stamps or postage meter strips, postmarks, and postal endorsements. See figure 3-4.

Correct and complete return addresses on mail are essential so correspondents may have the correct address of the mailer when making replies. Also, a correct return address is needed when the mail must be returned to the sender. The SNDL, parts 1 and 2, and annex A to part 1, lists the correct mailing addresses of military activities, ships, and other mobile units.

Don't ever take for granted that everyone attached to your command knows his/her correct address. Make sure that an example is posted where all hands can see it.

### ACCEPTABLE ADDRESSES

Mail addressed to civilian addresses must include in the address the following parts:

Name or identification of the intended recipient

Street and number, or box number, or general delivery, or rural highway number, if needed

ZIP Code (five-digit or ZIP + 4 where required)

### NONACCEPTABLE ADDRESSES

Articles addressed in the following manner are not acceptable for mailing:

Those having two or more addresses, except when a dual address containing both a street name and Post Office Box number is used. In this instance the intended delivery address must be placed on the line immediately above the city, state, and ZIP + 4 code. This is normally the Post Office Box address.

The name of more than one post office appears in the return address or in the recipient's address.

Those that bear instructions to return to point of mailing (postmark).

### ADDRESS PLACEMENT

Mailers should follow addressing guidelines that permit processing of letter-size mail on automated optical character readers (OCRs) and bar code sorters (BCSSs). The address, or at a minimum, the city, state, and ZIP Code lines of the address on letter-size mail should be located within an imaginary rectangle (the OCR read area) on the front of the mailpiece formed by the following boundaries:

At least 1/2 inch from the left edge

At least 1/2 inch from the right edge

At least 5/8 of an inch from the bottom edge (bottom line of rectangle)

No more than 2 3/4 inches from the bottom edge (top line of rectangle)

Figure 3-8 shows an example of address placement for letter-size mail.

The ZIP Code should appear on the last line of both the address of destination and return address, following the city and state. All mailers should use the ZIP + 4 code whenever possible. From one to two character spaces should be left between the last letter of the state name and the first digit of the ZIP Code. A comma should not be inserted between the state name and the ZIP Code. Figure 3-9 shows an example of proper ZIP Code placement. When the state name is abbreviated, the use of a period after the name is not required.

### SENDER'S INSTRUCTIONS FOR HOLDING MAIL

Below the return address the sender may request that mail, other than registered, insured, certified and return receipt for merchandise, be held for not less than 3 days nor more than 30 days. The sender may request

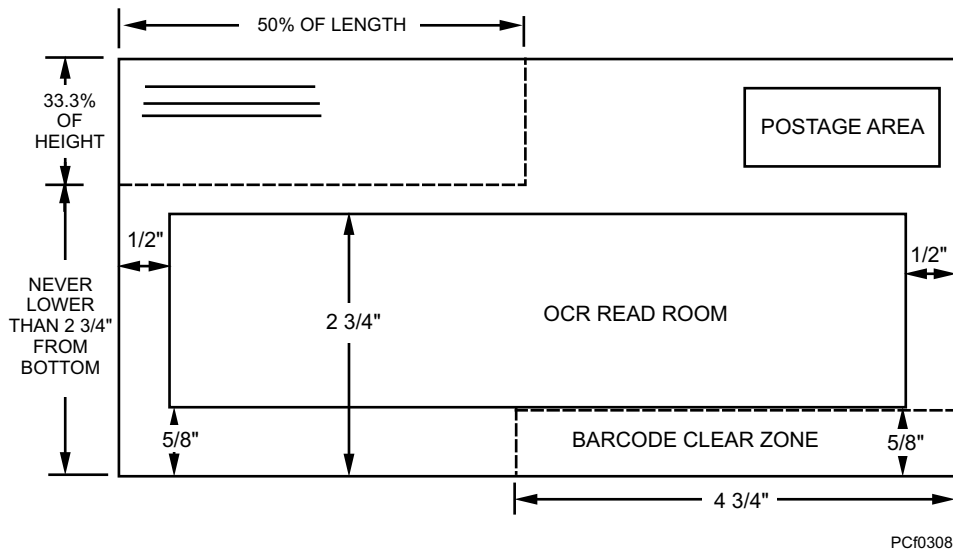

Figure 3-8.—Example of address placement on letter mail.

MR JOHN DOE  
 3484 WYANDOTTE ST  
 BATON ROUGE LA 70805-5868

Figure 3-9.—Example of ZIP Code placement.

that registered, insured, certified and return receipt for merchandise mail be held a maximum of 15 days. Accountable mail should not be held for less than 3 days.

### MILITARY ADDRESSES

Mail addressed to military addresses should be in the format shown in parts 1 and 2 of the SNDL, and Module A of the DMM (see figure 3-10). Some of the requirements for military addresses are as follows:

Only obvious abbreviations must be used such as U.S., USS, c/o, LST, FPO, and so forth.

Addresses of ships must include the full official name as well as the ship's class and hull number, such as USS John Paul Jones (DDG-32), and applicable FPO ZIP Code.

Addresses should include the four-digit add-ons for all official mail (add-on digits are located in the SNDL, parts 1 and 2, USPS PUB 65-A, and the USPS web site.

Addresses of Navy aircraft squadrons and detachments need only use the short designation such as VF-12. When the full name is used, it must also include the short designation such as Fighter Squadron 12 (VF 12).

Geographic locations must not be used together with an FPO or APO ZIP Code in a mail address unless assigned as a part of the official title.

FPO ZIP Codes assigned to a shore activity must not be used in addresses of ships, mobile commands, mobile units, or mobile detachments, unless assigned as a part of the address in the SNDL, part 1, or in a composite address for service craft overseas.

Whenever box numbers, barracks, or division numbers are used as a part of a mail address for purposes of speeding up local distribution of mail, they should be included on the second line of the address.

Mail must not be addressed to task forces, groups, elements, or units by task organization numbers (CTF 77, TF 77, CTG 80.2, and so forth) unless so listed in the SNDL.

Mail showing a foreign city and country in addition to the military address is subject to the rates of postage and conditions for international mail.

The use of an FPO ZIP Code has the following benefits:

- Affords greater control of mail
- Qualifies mail for domestic postal rates
- A uniform system for addressing mail



COMMANDING OFFICER  
USS LAWRENCE (DDG 4)  
FPO AE 09577-1234

YN1 JOHN DOE  
X DIVISION  
USS DEWEY (DDG 45)  
FPO AA 34090-1263

OFFICER IN CHARGE  
USS DYNAMIC (AFDL 6)  
NAVAL AMPHIBIOUS BASE  
LITTLE CREEK  
NORFOLK VA 23520-5250

COMMANDER SECOND FLEET  
FPO AE 09501-6000

COMMANDING OFFICER  
PATROL SQUADRON 44 (VP 44)  
FPO AE 09501-5917

OFFICER IN CHARGE  
MILITARY DEPARTMENT  
USNS HASSAYAMPA (T-AO 145)  
FPO AP 96667-4016

MASTER  
USNS HASSAYAMPA (T-AO 145)  
FPO AP 96667-4016

Figure 3-10.—Example of military addresses.

## FPO ADDRESSES

If each Navy ship or other mobile unit had its own geographical address, you can readily see what could happen should a ship or unit suddenly be deployed on an extended operation. For example, if a ship is homeported in San Diego, CA, but is on a deployment to the Far East, its mail would continue to go to San Diego. Official and personal mail would be needlessly held up while awaiting forwarding instructions. By having a standard FPO address, all mail is consolidated at the postal concentration centers (PCCs) located in the same area of each JMPA or element.

Personnel at the JMPAs do not physically handle the mail as all handling and processing is done by civilian postal employees. When your ship deploys, the servicing JMPA furnishes the PCC with routing and dispatching instructions so that mail will be forwarded as per the ship's schedule.

## MAIL SENT VIA DEPARTMENT OF STATE

Nonaccountable mail may be sent to authorized U.S. foreign service and assigned military personnel stationed in foreign countries via Department of State facilities. Mail addressed to personnel in this category must be in the following format:

NAME  
FOREIGN CITY (omit name of country)  
DEPARTMENT OF STATE  
WASHINGTON DC 20521-5000

- Q3-13. *What does the first digit of a ZIP Code identify?*
- Q3-14. *Individual ZIP Codes are assigned to naval ships based on the size of their crew. (True/False)*
- Q3-15. *The specific FPO address assigned to a U.S. Navy ship is determined by what factor?*
- Q3-16. *What publication lists the correct mailing addresses of Naval activities?*
- Q3-17. *When a box number or division number is part of a military address, on what line should it be included?*
- Q3-18. *List at least two benefits received by the assignment of an FPO address.*
- Q3-19. *What organization provides a postal concentration center with routing and dispatching instructions for mobile units?*

Now turn to appendix 1 to check your answers.

## NONMAILABLE MATTER

---

**Learning Objective:** *Differentiate between mailable and nonmailable material.*

---

As you learned earlier in this chapter, before an item may be accepted for mailing, it must meet certain conditions. Depending on the nature of the item, this may include specific methods of packaging, closure,

sealing, addressing, or marking. Containers must be strong enough to retain and protect the contents during normal mail handling. Items that are not packed well enough to withstand normal handling must be refused.

U.S. Postal Service regulations state “anything which may kill or injure another, or in any way damage the mails or other property is nonmailable.” However, there are exceptions to this rule. Certain matter that has been declared nonmailable may be mailed under certain conditions. This section describes some of those items and substances that are prohibited from the mail and the conditions under which certain items may be mailed.

As you learn to become a window clerk, you must be alert in detecting violations of regulations concerning nonmailable matter. To assist the mailer in ensuring that nonmailable matter is not deposited in the mail, you should ask the customer what is in the parcel before you accept it. Once you have done this, the responsibility for the article’s contents is on the mailer.

## RULES AND PROCEDURES

---

**Learning Objective:** *Recall the rules and procedures regarding the acceptance of articles for mailing.*

---

Both the mailer and you, as a window clerk, play an important part in keeping nonmailable and potential harmful and dangerous matter from the mail. As a military postal clerk, you must have a broad knowledge of those items that are nonmailable and those that may be mailed under certain conditions. You should assist the mailer by providing him/her with this information. This information may be found in such sources as the DMM, *USPS Publication 52*, and the IMM. Information may also be obtained from fleet mail centers, other military post offices, or senior postal clerks if you are outside of the United States. In the United States you should contact the nearest civilian post office or Navy postal assistance advisor.

### MAILER’S RESPONSIBILITY

The mailer is responsible for ensuring items presented for mailing are not prohibited by postal laws or regulations. The mailer is also required to comply with nonpostal laws and regulations pertaining to the possession, treatment, transmission, or the transfer of certain matter. Nonpostal laws are those laws that have

been enacted by Congress. In addition, certain regulations issued by government agencies (such as the Department of Transportation, Bureau of Alcohol, Tobacco and Firearms, and so forth) concerning interstate transportation must be adhered to.

### PROCEDURES FOR ACCEPTING CLERKS

When you are assigned to a post office window accepting articles for mailing, you must be alert for articles and substances that are nonmailable. If the contents of an article presented for mailing are described by the mailer as, or are revealed otherwise to be nonmailable, you must refuse to accept the article. When some items are identified to be nonmailable as packaged, preparation and packaging requirements must be met before the package can be accepted. If the mailer fails to properly package the item, you must refuse it. In any case, explain the reasons why you cannot accept the package and refer the person to the applicable module of the DMM.

### GENERAL ADVICE TO MAILERS

Sometimes a postal customer may seek advice as to whether, or under what conditions, certain matter may be mailed. If a postal customer seeks this advice or it appears that a person will mail dangerous matter, you should call the person’s attention to Module C of the DMM. Military postal personnel are not authorized to decide whether written, printed, or graphic matter is nonmailable or deny entry or exclude such matter from the mails.

On the other hand, military postal personnel may decide whether articles and substances other than written, printed, or graphic matter are nonmailable. These articles are listed in Module C of the DMM and in this section, and must be refused.

### INJURIOUS ARTICLES

Generally, any article, composition, or material that may kill or injure another, or damage the mail or other property, is nonmailable. The items listed here are generally nonmailable to, from, or between military post offices. However, some of these articles may be mailed under certain conditions. The conditions may include special packaging, whether or not the article is sent as official government business, and so forth. If any of these articles are presented for mailing, they are reason for suspect, and Module C of the DMM or *USPS Publication 52* should be checked

before accepting or refusing the article. Harmful matter includes the following:

- All kinds of poison including narcotic drugs
- All poisonous animals, poisonous insects (except scorpions), poisonous reptiles, and all kinds of snakes
- All disease germs
- Acids, alkalis, and oxidizers
- Highly flammable liquids, gases, or solids
- Ammunition and fireworks
- Radioactive materials
- Articles emitting obnoxious odors

### **OTHER NONMAILABLE MATTER**

Matter is also nonmailable if it cannot be forwarded to its destination because the address is illegible, incorrect, or insufficient.

Also, articles may be nonmailable because they fail to comply with postal regulations in regard to preparation, classification, rate of postage, size, and weight.

### **WRITTEN, PRINTED, OR GRAPHIC MATTER**

---

**Learning Objective:** *Recognize nonmailable written, printed, or graphic material.*

---

While certain written, printed, or graphic matter has been declared nonmailable, military postal clerks may not exclude such matter from the mails. If a patron presents written matter for mailing and you suspect it to be nonmailable because of content, you should call to the attention of the mailer, the applicable module of the DMM. If, after you have done this, the mailer still insists that the article be accepted, accept it. Events of this nature should be reported to your supervisor or postal officer. The following is a list of nonmailable written and printed matter that you may encounter as a military postal clerk. Refer to Module C of the DMM for additional information:

Nonmailable matter includes but is not limited to:

- Lottery matter
- Solicitations or inducements for mailing harmful matter, radioactive material, switchblade knives, or intoxicating liquor
- Copyright violations
- Lewd or filthy matter
- Libelous matter
- Matter relating to national or international defense

### **HAZARDOUS MATTER**

---

**Learning Objective:** *Determine mailability of hazardous matter.*

---

Items that have been classified as hazardous matter include, in general terms, chemicals, explosives, flammable materials, matches, poisons, and controlled substances. Whether these items are acceptable at all, or only under certain conditions, depends upon several factors such as the following:

- Type of container and capacity
  - Proper packaging
  - Method of absorbing and containing the product in case of accidental leakage
  - Flash point
  - Irritant action to eyes and skin
- Explosives of all kinds are nonmailable.

### **FLAMMABLE MATERIALS**

Flammable liquid is prohibited in the international mail. Flammable liquid with a flash point between 20°F or 100°F is acceptable for domestic surface transportation when it meets the container requirements in Module C of the DMM.

Combustible liquids are prohibited in the international mail. Combustible liquids may be accepted for domestic surface or air transportation when the requirements in Module C of the DMM are met.

A flammable solid is any material, other than one classified as an explosive, that may cause fires through

friction (rubbing together). Flammable solids may only be accepted in the domestic surface mail. They are not acceptable for air transportation or international mail.

For current instructions on mailing flammable materials, refer to Module C of the DMM or *USPS Publication 52*.

## MATCHES

Strike-anywhere matches may not be mailed under any conditions. Safety matches (book, card, or strike-on-box) may be mailed in the domestic mail under certain conditions. Generally they must be of a type that will not ignite spontaneously. Matches of all types may not be mailed to, from, or between military post offices or in the international mail.

## TOXIC SUBSTANCES

USPS regulations define a toxic substance as a poisonous material, other than gas, that is known to be so toxic to humans as to cause death, injury, or harm to human health if swallowed, inhaled, or contacted by skin.

Toxic substances or poisons are prohibited in international mail. For domestic mail refer to Module C of the DMM for packaging and mailing conditions.

## CONTROLLED SUBSTANCES

A controlled substance is any anabolic steroid, narcotic, hallucinogenic, stimulant, or depressant drug in schedules I through V of the Controlled Substance Act. Narcotic drugs include opium, cocaine and opiates, and drugs made from them (heroin and morphine). Controlled substances, by reason of their addictive nature, have been declared as articles, compositions, or materials that may kill or injure another.

If distribution of a controlled substance is considered lawful under the Controlled Substance Act, refer to Module C of the DMM for mailing conditions.

*Q3-20. Whose responsibility is it to ensure that items and substances prohibited by postal laws and regulations are not mailed?*

*Q3-21. Define the term injurious article.*

*Q3-22. What is the general rule concerning injurious articles being mailed to, from, or between military post offices?*

*Q3-23. Under no circumstances may injurious articles ever be inserted into the USPS or MPS mail system. (True/False). Explain.*

*Q3-24. Under what special conditions, if any, may strike-anywhere matches be mailed to an MPO or foreign country?*

Now turn to appendix 1 to check your answers.

## MAIL BOMBS

---

**Learning Objective:** *Recognize the characteristics of and the procedures for handling mail bombs.*

---

Because of an increase of worldwide terrorist activities today, we must not laugh at the myth of mail bombs. You, as an MPC, could be in the position to determine what to do in a crisis situation to increase awareness and also to give some guidance in identifying suspected mail bombs. The information listed below could help you deal with this situation.

Keep in mind that a bomb can be enclosed in either a parcel or an envelope. There is not a set pattern of the outward appearance of the parcel or envelope. The form of a letter bomb is limited only by the imagination of the sender. Mail bombs will usually have unique characteristics, some of which are listed below:

Mail bombs may bear restricted endorsements such as PERSONAL or PRIVATE.

The addressee's name and/or title may be inaccurate.

Mail bombs may reflect distorted handwriting or the name and address may be prepared with homemade labels or cut-and-paste lettering.

Mail bombs may have protruding wires, aluminum foil, or oil stains visible and may emit a peculiar odor.

Mail bombs may have an excessive amount of postage stamps affixed.

Letter-type bombs may feel rigid or appear uneven or lopsided.

Parcel bombs may be unprofessionally wrapped with several combinations of tape used to secure the package and may be endorsed

FRAGILE—HANDLE WITH CARE or RUSH—DO NOT DELAY.

Parcel bombs may make a buzzing or ticking noise, or a sloshing sound.

Pressure or resistance may be noted when removing contents from an envelope or parcel.

If you, or anyone in your MPO, ever discover or are suspicious of a piece of mail or parcel and are unable to verify the contents of an article, you must observe the following safety precautions:

DO NOT OPEN the article.

Isolate the article and evacuate the area immediately.

Do not put the article in a bucket of water or a confined space such as a desk drawer or file cabinet.

If time allows, open windows in the immediate area. This will help to clear the air of potentially explosive gases.

Make sure you take NO chances, and don't worry of possible embarrassment if the article turns out to be a hoax. Contact the appropriate officials for assistance.

For handling and reporting of articles reasonably suspected of being dangerous to persons (as discussed earlier in this chapter) or suspected as letter bombs, refer to the *DOD Postal Manual*, volume I, chapter 9.

## RESTRICTED MATTER

---

**Learning Objective:** *Recognize the procedures for mailing restricted matter.*

---

Restricted matter is articles or substances specifically prohibited in the mails, or are mailable only under limited conditions because they may be injurious to life, health, or property. Included as restricted matter are obnoxious odors (any matter emitting an obnoxious odor is nonmailable) certain liquids, powders, battery-powered devices, and sharp objects.

## INTOXICATING LIQUORS

An intoxicating liquor is a potable beverage that contains 0.5 percent or more of alcohol by weight.

This small amount of alcohol content will almost always include all whiskeys, wines, and beers. For mailing purposes, you should not accept any alcoholic beverage at a military post office.

## LIQUIDS AND POWDERS

Liquids and semisolids that may liquefy under normal conditions and are otherwise mailable may be mailed if properly packaged (refer to Module C of the DMM). Powders, which if allowed to escape from their containers, could cause damage, discomfort, destruction, or soiling, must either be packed in siftproof containers or in other containers sealed in durable, siftproof outer containers.

## BATTERY-POWERED DEVICES

Devices that are powered by dry cell batteries may be mailed if the batteries have been removed or deactivated. The batteries may be shipped in the same parcel provided they will not come in contact with the device in such a way as to cause activation. Batteries with liquid electrolyte (a solution that will conduct a current) are not permitted in the mail unless they are nonspillable type batteries that meet the standards in Module C of the DMM.

## ODD-SHAPED ITEMS IN ENVELOPES

Odd-shaped items such as pens and bottle caps are not acceptable if mailed in letter-style envelopes. These types of envelopes are generally of insufficient strength to hold items other than normal paper correspondence. Envelopes containing odd-shaped objects could burst and the contents damage mail-processing equipment or injure postal personnel.

## KNIVES AND SHARP OBJECTS

Knives (including sharp-pointed instruments such as stilettos that lack cutting edges) with a blade that opens automatically by hand pressure applied to a button or other device in the handle, or by operations of inertia, gravity, or both, or with a detachable blade propelled by a spring-operated mechanism, are mailable only when sent to:

A government or organization's designated supply or procurement officer and employees ordering, procuring, or buying such knives for use with activities of the federal government.

Manufactures of such knives or bona fide dealers of such knives, in connection with a shipment made under an order from any person listed above.

Sharp-pointed or sharp-edged instruments that are mailable may be accepted if properly wrapped and packaged. These instruments include knives, tools, ice picks, razor blades, and so forth. The points and sharp edges must be wrapped to protect them from cutting or punching through the outer container.

## **MARKING OF PARCELS**

Any parcel containing firearms, ballistic or switchblade knives, or controlled substances (narcotic drugs) must NOT have any marking on the outside wrapper or container that would indicate the nature of the contents. For specific markings for other hazardous materials, refer to Module C of the DMM.

## **FIREARMS**

Among the articles that are mailable only under special rules and regulations are firearms and, in particular, concealable firearms. A firearm as defined by the USPS is “any device, including a starter gun, which is designed to or may readily be converted to expel a projectile by the action of an explosion, spring, or other mechanical action, or air or gas pressure with sufficient force to be used as a weapon.” The rules and regulations set down by the USPS and the Gun Control Act of 1968 (Public Law 90-618) are rigid and may not be adjusted to fit any special situation.

### **Handguns**

The term *handgun* means any pistol or revolver styled to be fired by the use of a single hand. Pistols, revolvers, and other firearms capable of being concealed on a person may only be mailed under certain conditions. Short-barreled shotguns and short-barreled rifles are also considered as capable of being concealed on a person.

Handguns can only be mailed by a licensed manufacturer of firearms, a licensed dealer, or an authorized agent of the federal government or the government of a state, district, or territory. Persons authorized to receive handguns through the mail for use in connection with official duties include the following:

Officers of the Army, Navy, Air Force, Coast Guard, Marine Corps, or organized Reserve Corps

Officers of the National Guard or militia of a state, district, or territory

Officers of the United States or of a state, territory, or district whose official duty is to serve warrants of arrest or commitment

Watchmen engaged in guarding the property of the United States, a state, territory, or district

At a military post office the only person that may legally receive a handgun is an officer of the U.S. Armed Forces or a licensed dealer. The Navy exchange officer may be a licensed dealer and, therefore, would be authorized to receive and mail handguns. Under no circumstances may any person mail or receive a handgun for personal use.

### **Affidavits and Certificates**

Before an authorized firearms manufacturer or dealer may mail a handgun to an officer of the U.S. Armed Forces, the officer is required to provide the shipper with an affidavit. An affidavit for this purpose is a signed statement that the addressee of the handgun is authorized to receive it, and also, that the firearm is for official use. In addition, the affidavit must bear a certificate that the handgun is for official use of the addressee and must be signed by the individual’s commanding officer. The firearms dealer or manufacturer must then file the affidavit and certificate with the postmaster at the office of mailing.

A licensed firearms manufacturer or dealer must file at the post office of mailing a PS Form 1508, Statement by Shipper of Firearms. This form signed by the shipper simply states that the shipper is a licensed firearms dealer or manufacturer and that the parcel contains a handgun or parts. If there is a licensed firearm dealer located on the base, a PS Form 1508 must be presented at the time the dealer desires to mail a handgun. An affidavit or certificate is not required if a handgun is mailed by the command as an official shipment. The Department of Defense has ruled that members or officers of a rod and gun club may NOT send nor receive handguns through the mail.

### **Rifles and Shotguns**

Rifles and shotguns may be mailed without an affidavit or certificate that is required for handguns.

However, the mailer is responsible for complying with the Gun Control Act of 1968 as well as state and local laws. You must require the mailer to establish proof that the gun is unloaded at the time it is presented for mailing. You must require the mailer to open the parcel or provide in writing a statement that the gun is NOT loaded.

Short-barreled rifles and shotguns may not be accepted in the mail. A short-barreled shotgun is one that has one or more barrels that are less than 18 inches in length. A short-barreled rifle is one that has a barrel less than 16 inches in length. A rifle or shotgun is also nonmailable if the overall length is less than 26 inches.

### Antique Firearms

An antique firearm is any firearm manufactured in or before 1898. This includes firearms with a matchlock, flintlock, percussion cap, or similar type of ignition system. A replica of an antique firearm may be mailed if it meets the following requirements:

It is not designed or redesigned for using rimfire or conventional centerfire fixed ammunition.

It uses rimfire or conventional centerfire fixed ammunition that is no longer manufactured in the United States and is not readily available in the ordinary channels of commercial trade.

An antique firearm may be mailed or received by any authorized mailer if sent or received as a museum piece.

### AGRICULTURE IMPORT REQUIREMENTS

Normally, because of quarantine regulations, all packages mailed from military post offices overseas may not contain the following articles if addressed for delivery in the United States:

Fruits

Vegetables

Plants or plant parts

Live animals, birds, or insects

Meats and animal and dairy products

Soil or sand

Souvenirs stuffed with straw

Animal trophies unless taxidermist finished

### MAIL ADDRESSED TO APOs AND FPOs

Any time a parcel is presented for mailing, which is addressed to an APO or FPO, be sure to check the Conditions Applied to Mail Addressed to Military Post Offices Overseas (obtained from the Postal Bulletin) for any possible restrictions. Some APOs and FPOs have weight and size limits that may be lower than those allowed if mailed to the United States.

Also, even though some items may be acceptable for mailing when addressed for delivery in the United States, they may not be permitted in the country in which the military post office is located. If you have any doubts as to the mailability of an article, refer to the DMM and also check with your supervisor or postal officer. When a nonmailable article is discovered in the mail, it should be withdrawn and referred to your supervisor or postal officer.

*Q3-25. If an article is suspected of being a letter bomb, you should never throw it over the side of the ship, put it in a bucket of water, or in a desk drawer to confine possible damage. (True/False)*

*Q3-26. Under what conditions may intoxicating liquors be entered into the Military Postal System?*

*Q3-27. Under what special condition may powders be entered into the U.S. Mail system?*

*Q3-28. Explain the procedures that must be followed before battery-powered devices can be mailed.*

*Q3-29. For a firearm to qualify as an antique firearm, it must have been manufactured in or before what year?*

Now turn to appendix 1 to check your answers.

### WINDOW EQUIPMENT

---

**Learning Objective:** *Identify the different types of post office equipment.*

---

The size of your post office will determine the type of equipment required for your use. As a minimum, you will have one or two types of scales, money order imprinter (chapter 8), various types of forms, and rubber stamps to mark articles for the services

requested by the customer(s). At larger post offices you will more than likely have a postage meter and an integrated retail terminal (IRT) (chapter 8) to assist you in conducting window business. All postal finance windows should have a calculator. Learn the proper uses of the equipment you have on hand, and the techniques of operation. This section will help you in this regard.

## SCALES

One of the most important pieces of window equipment is the scale. If scales are not accurate, postage rates are not accurately computed. Scales that are used at postal finance windows should be checked for accuracy and/or zero balanced each day before opening for business. Scales that cannot be balanced should be removed from service.

### Automatic Computing Scale

As a window clerk, you will most likely use a dial-type automatic computing scale similar to the one in figure 3-11. A rate chart is attached to the automatic computing scale. This type of scale offers easy-to-read indicators that display the amount of postage to charge, depending on the zone and the weight of the article. This type of scale is normally used to weigh large or heavy articles. If postage rates change, new rate charts will be automatically distributed. However, if you do not receive the new chart, a new scale chart can be ordered by following the procedures in *USPS Publication 247*.

### Beam Scales

The 1-pound beam scale is another type of scale that is frequently used to conduct window business. A drawing of a 1-pound beam scale and its parts are shown in figure 3-12. This scale is used to weigh large envelopes and other small articles. It has weight graduations of 1/2 ounce up to a maximum capacity of 16 ounces. Unlike the automatic computing scale, you must manually slide the poise up or down the beam until you get a balance for the correct weight. A larger beam scale with a maximum capacity of 4 pounds is used for weighing large, heavy articles. Beam scales are also available in a 100-pound capacity. Some MPOs have the 100-pound beam scale instead of the 70-pound automatic computing scale. (See figure 3-13.)

## Balancing the Beam Scales

The accuracy of beam-type scales may be checked by setting the movable weight at zero. If the scale is in balance, the indicator will come to rest exactly even with the line on the right of the scale. If the indicator comes to rest below the line, the scale is weighing light; that is, the scale would indicate that a letter weighing 1 ounce weighs less than 1 ounce. On the other hand, if the indicator comes to rest above the line, the scale is weighing heavy and would show letters weighing exactly 1 ounce to be more than 1 ounce.

It is easy to adjust the scale by means of the screw at the end of the weight indicator. To balance, turn screw on the frame of the scale. Using a small screwdriver, you can adjust the screw until the scale is brought into balance. When the scale is weighing light (indicator below line), turn the screw to the right (clockwise). When the scale is weighing heavy (indicator above line), turn the screw to the left. A slight turn of the screw will usually balance the scale. You should experiment until it is exactly in balance.

## Electronic Computing Scale

As the automatic computing scales and 100-pound beam scales used by MPOs become irreparable and replacement is necessary, the MPOs will be issued the new electronic computing scale. The electronic computing scale has the following features:

- Standard RS-232 interface with a selectable output for communications with a computer.
- Adjustable response time.
- Optional push buttons.
- Optional remote displays.
- Single board electronics for ease of servicing.
- Single button selection of two weighing units.

When calibration becomes necessary, the scale can be calibrated using the existing keypad or through the RS-232 interface.

## CALCULATORS

One of the most useful and versatile machines in a post office is the calculator. The calculator is capable of adding, subtracting, multiplying, and dividing, and Navy post offices should use calculators that have the ability to print a tape. Its use is a must in performing many of the calculations done in the post office, such





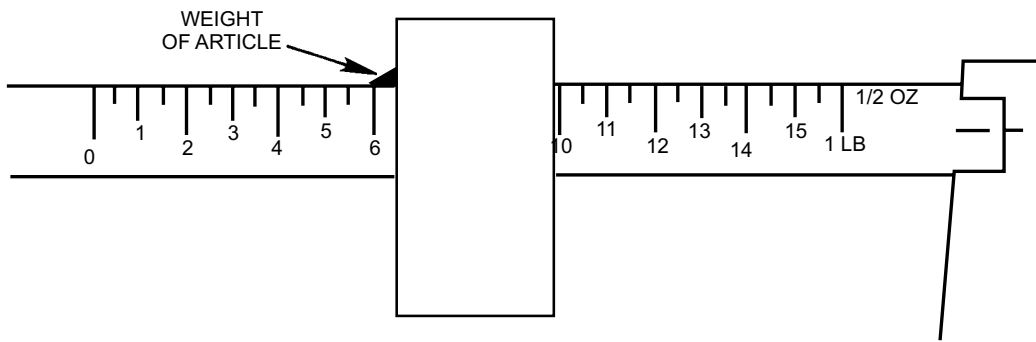
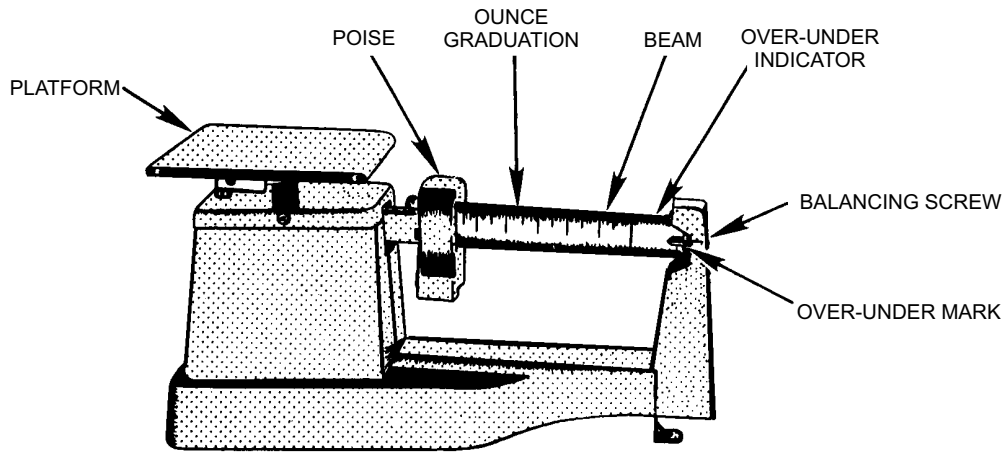

Figure 3-12.—Beam scale.

PCf0312

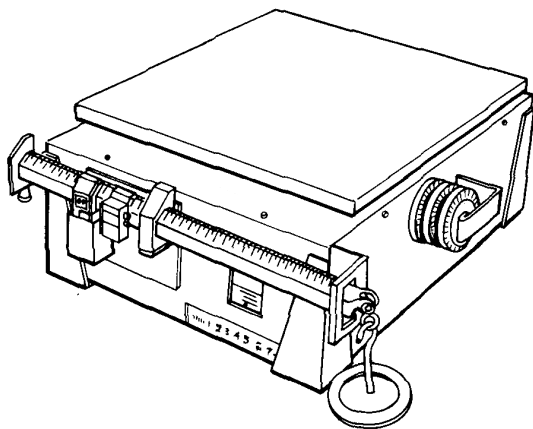

Figure 3-13.—100-pound beam scale.

PCf0313

as completing a mail dispatch manifest or preparing money order reports. This will be discussed later in this training manual.

The most common type of calculator found in military post offices is the electronic solid-state machine (see figure 3-14). The same general principles apply for all operating calculators; however, keyboard arrangements vary slightly depending on the manufacturer and model. You will have to learn the

details of your machine from an experienced operator or by studying the manufacturer's instruction booklet.

All calculators are precision instruments and must be protected from bumps and jars that will upset the delicate balance of their mechanism. As with other office machines, dust and dirt are big enemies. Keep your calculator clean and covered when not in use. If the machine is not operating properly, immediately



Figure 3-14. Example of an electronic calculator used at most MPOs.

PCf0314

unplug it. Do not attempt to repair calculators yourself. All repairs and maintenance should be done by qualified technicians or company representatives. Because it is solid-state, the electronic calculator needs little maintenance. Ensure all electrical equipment aboard Navy ships comply with all safety regulations.

## TYPEWRITERS

Your typewriter may be heavy and rugged looking, but it is really a delicate instrument. Treat it like one and give it daily care. A machine in first class condition is easier and quicker to operate and turns out professional looking work.

Observe the following routine procedures:

Be sure the typewriter is properly placed on the desk, or secured to the well type of desk, so it will not fall. Aboard ship, it should always be secured.

In lifting a typewriter, grip it by its case, NEVER by its carriage.

Keep your typewriter covered when not in use. Always cover it or close it into the desk at the end of the day.

Keep it clean, wiping the outside with a soft dry cloth and dusting the inside with a long-handled brush.

At regular intervals you should give the typewriter a more thorough cleaning. Frequency of these cleanings will depend on the amount of use the typewriter receives and the amount of dust in the air in your office. In general, it is recommended that the following procedures be carried out weekly:

Clean the carriage rails and marginal stop bar, using a cloth slightly moistened with lubricating oil. Move the carriage back and forth in the process.

Clean the cylinder or roller. Remove if possible and wipe with a cloth moistened with a very

small amount of denatured alcohol or cleaning fluid. Do not wipe off; allow fluid to evaporate.

Dust the interior of the machine. Use a long-handled brush, brushing toward the front of the machine.

Wipe the sides and back of the machine.

If operating instructions for your typewriter are available, they will help you identify parts and give you additional information.

If further oiling or repair work is needed, the machine should be turned over to a qualified repairman.

## COMPUTERS

The world is constantly changing. Using computers has changed the way business is done. Today's Navy operates through the use of modern state-of-the-art weapons and computer systems. New computer technology has had a tremendous impact on the efficiency of operation, and as a PC, you will be able to accomplish more by using a computer. Because of this advanced computer technology, as the publications and forms used in a post office become more available in computer format, administrative jobs that used to take a long time to accomplish can be done rapidly and more easily. Not all Navy post offices have computers, but they are becoming more common.

*Q3-30. What determines the type of post office equipment that will be placed in your MPO?*

*Q3-31. How often must scales that are used at the finance window be checked for accuracy?*

*Q3-32. What publication must be referred to when postage rate charts are ordered for automatic computing scales?*

Now turn to appendix 1 to check your answers.



## CHAPTER 4

# DOMESTIC MAIL

Now that you are ready to conduct postal finance business, let us learn about domestic mail. In this chapter domestic mail will be defined and you will be introduced to the different classes of mail and rates of postage.

### INTRODUCTION TO DOMESTIC MAIL

**Learning Objective:** *Recall the areas that fall under the domestic mail system.*

The definition of Domestic Mail as stated in the DMM is: “Domestic mail is mail transmitted within, among, and between the United States; its territories and possessions; Army-Air Force post offices (APOs), fleet (Navy) post offices (FPOs), and the United Nations, NY. To understand what the term *territories and possessions* means, see table 4-1.

Mail originating in the United States (U.S.), its territories and possessions, APOs, FPOs, and the United Nations, NY, for delivery in the Freely Associated States, and mail originating in the Freely Associated States for delivery within, among, and between the Freely Associated States and the U.S., its

territories and possessions, APOs, FPOs, and the United Nations, NY, is also treated as domestic mail. To understand what the term *Freely Associated States* means, see table 4-2.

From the definition and tables 4-1 and 4-2, you can see it is possible to send a letter halfway around the world and be subject to the same rate of postage as you would for a letter going around the corner from one address in a city in the U.S. to another address in the same city.

Domestic mail is divided into classes according to the contents and weight of the article being mailed, and possibly according to the wishes of the sender.

As a postal clerk working a window, you will be accepting many different types of articles, such as letters, merchandise, books, and magazines, just to name a few. Before you accept any article for mailing, you must determine what class of mail it is and by what method it is to be sent. Domestic mail is classified by weight, contents, and service. Domestic mail is divided into five classes: (1) Express, (2) First-Class, (3) Periodicals, (4) Standard Mail A, and (5) Standard Mail B.

**Table 4-1.—U. S. territories and possessions.**

<b>U. S. Territories and Possessions</b>	
American Samoa Manua Island, Swain’s Island, Tutuila Island  Baker Island Guam Howland Island Jarvis Island Johnston Atoll East Island, Johnston Island, North Island, Sand Island  Kingman Reef Midway Atoll Eastern Island, Sand Island, Spit Island	Navassa Island Commonwealth of the Northern Mariana Island Rota Island, Saipan Island, Tinian Island  Palmyra Island Commonwealth of Puerto Rico U. S. Virgin Islands St. Croix Island, St. John Island, St. Thomas Island  Wake Atoll Peale Island, Wake Island, Wilkes Island

Table 4-2.—Freely Associated States.

Freely Associated States	
Republic of the Marshall Islands Ebeye Island, Majuro Island Republic of Palau Koror Island	Federated States of Micronesia Chuuk (Truk) Island, Kosrae Island Pohnpei Island, Yap Island

**SIZE LIMITS**

**Learning Objective:** *Recall the procedures for measuring items for mailing.*

The maximum size that any article may be, and still be mailable, is 108 inches in length and girth combined except for Standard Mail (B) parcels that are mailed as

oversized mail (130 inches length and girth combined). You might ask, what is meant by the girth? How do I figure the size of an article? Figure 4-1 shows how the length and girth of certain articles are measured. The size of an article is determined by:

- Measuring the longest side to get the length.
- Measuring the distance around the article (girth). See figure 4-1.

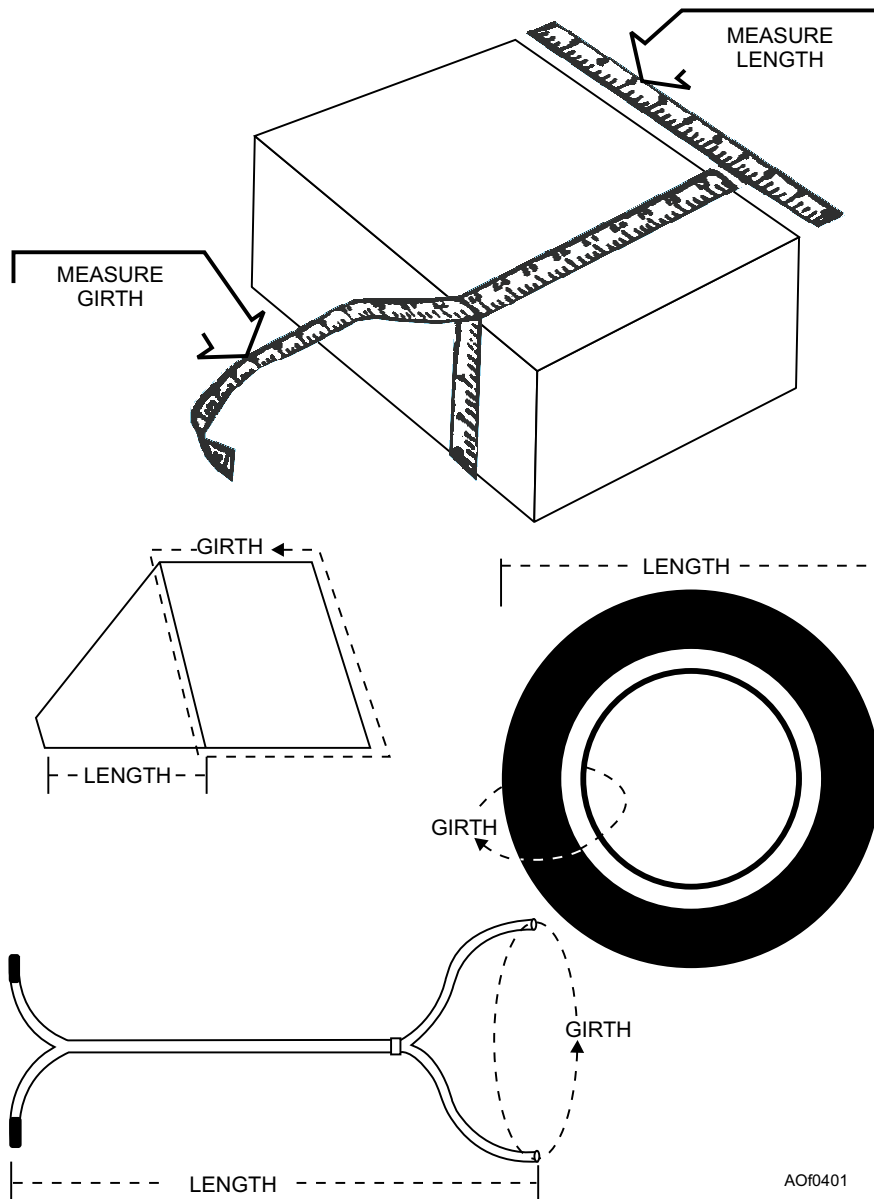

AO10401

Figure 4-1—How to measure a parcel.

- Adding the measurements of the length and girth. This will give you the size of the article.

Example: If an article's length is 15 inches, the width is 12 inches, and the height is 6 inches, the size would be computed as follows:

- 15 inches long (L)
- 12 inches wide (W) ( $12 \times 2 = 24$ )
- 6 inches high (H) ( $6 \times 2 = 12$ )
- Girth (G) = 36 inches ( $2W + 2H$ )
- 51 inches total size (L + G) ( $15 + 36$ )

If an article is not square or rectangular in shape, the measurements are taken at the greatest dimensions. For example, if a package is in the shape of a cone, the girth is measured at its base. If an article exceeds 108 inches in length and girth combined, it is too large and is not mailable (except for oversized Standard Mail (B)). Refer to the USPS Postal Bulletin (Conditions Applied to Mail Addressed to Military Post Offices Overseas), for size and weight limits for articles addressed to APO and FPO addresses, because some APOs and FPOs have lower size and weight limits.

## EXPRESS MAIL

---

**Learning Objective:** *Recognize the procedures for the acceptance and processing of Express Mail.*

---

Express Mail provides extremely reliable, expedited delivery service for all mailable matter. Express Mail Military Service (EMMS) is the only Express Mail service available at MPOs. EMMS provides 2- or 3-day delivery service to and from most military locations overseas. EMMS is not available for personnel aboard ships and at some APO/FPO locations.

Express Mail receives priority handling from the time of acceptance until it is delivered to the addressee. Express Mail moves along specific networks, determined in advance, and represent the authorized routing between any acceptance point and delivery ZIP Code. The use of the network assures on-time delivery or a full refund if the delivery is late.

### ACCEPTANCE

The maximum weight for Express Mail is 70 pounds, and the maximum size is 108 inches length

and girth combined. Before accepting Express Mail, the MPO clerk must ensure the customer has completed the "FROM" and "TO" address blocks of USPS Label 11-B (Express Mail Post Office to Addressee) (see figure 4-2) and affix the label to the article. These labels are available in the post office lobby. The clerk will complete the post office portion of the Label 11-B when accepting the piece of mail and then affix to the article a USPS Label 86 (Express Mail Military Service).

### DETERMINING POSTAGE

When accepting a piece of EXPRESS Mail, clerks must always:

- determine if the article is mailable,
- ensure the article does not exceed the weight and size limit, and
- ensure Label 11-B is properly filled out and attached.

After completing the above requirements, use the Express Mail rate chart located in Module R of the DMM to determine the proper postage rate. Notice that the first weight indicated on the express chart is 1/2 pound (8 ounces) and then 1 pound. To determine the postage rate, find the article's weight on the chart. Then find the dollar amount located in the Next Day & Second Day PO to Addressee column. The amount listed indicates the correct postage rate.

### PACKAGING

Military post offices provide their customers, free of charge, two types of Express Mail envelopes. The first, EP13A, is a "10 x 14 1/2" envelope used for mailing documents or merchandise. The rate of postage charged is based on the actual weight of the article. The second envelope, EP13F, is a "Flat Rate Envelope." The Flat Rate Envelope allows customers to place as much merchandise in the envelope as it will hold, but they will only be charged the two-pound postage rate. MPOs also provide their customers with other Express Mail containers such as boxes, tubes, and larger envelopes.

### USPS LABEL 11-B

Label 11-B figure 4-2, is a four-part carbonless form. These labels should be made available in the MPO lobby. Use the instructions listed below to guide you through completing Label 11-B.

**EXPRESS MAIL**  
UNITED STATES POSTAL SERVICE™

**POST OFFICE TO ADDRESSEE** EJ638876924US

ORIGIN (POSTAL USE ONLY)			DELIVERY (POSTAL USE ONLY)		
PO ZIP Code ①	Day of Delivery <input type="checkbox"/> Next <input type="checkbox"/> Second	Flat Rate Envelope <input type="checkbox"/>	Delivery Attempt	Time <input type="checkbox"/> AM <input type="checkbox"/> PM	Employee Signature
Date In Mo. Day Year ②	<input type="checkbox"/> 12 Noon <input type="checkbox"/> 3 PM ⑤	Postage \$ ⑧	Delivery Attempt	Time <input type="checkbox"/> AM <input type="checkbox"/> PM	Employee Signature
Time In <input type="checkbox"/> AM <input type="checkbox"/> PM ③	Military <input type="checkbox"/> 2nd Day <input type="checkbox"/> 3rd Day ⑥	Return Receipt Fee	Delivery Date	Time <input type="checkbox"/> AM <input type="checkbox"/> PM	Employee Signature
Weight lbs. ozs. ④	Int'l Alpha Country Code	COD Fee Insurance Fee	Signature of Addressee or Agent		
No Delivery <input type="checkbox"/> Weekend <input type="checkbox"/> Holiday	Acceptance Clerk Initials ⑦	Total Postage & Fees \$ ⑨	X Name - Please Print		

**CUSTOMER USE ONLY**

METHOD OF PAYMENT:  
Express Mail Corporate Acct. No. \_\_\_\_\_  
Federal Agency Acct. No. or Postal Service Acct. No. \_\_\_\_\_

**WAIVER OF SIGNATURE** (Domestic Only) Additional merchandise insurance is void if waiver of signature is requested. I wish delivery to be made without obtaining signature of addressee or addressee's agent (if delivery employee judges that article can be left in secure location) and I authorize that delivery employee's signature constitutes valid proof of delivery.

**NO DELIVERY**  Weekend  Holiday \_\_\_\_\_ Customer Signature

**FROM: (PLEASE PRINT)** PHONE ( ) \_\_\_\_\_  
⑪

**TO: (PLEASE PRINT)** PHONE ( ) \_\_\_\_\_  
⑩

**PRESS HARD.** You are making 3 copies. **FOR PICKUP OR TRACKING CALL 1-800-222-1811** [www.usps.gov](http://www.usps.gov) **EMS**

Label 11-B July 1997

A0f0402C

Figure 4-2.—Label 11-B, Express Mail Post Office to Addressee.

To be completed by the accepting clerk:

- Block 1: Enter your MPO's 5-digit ZIP Code.
- Block 2: Enter current Month, Day, and Year.
- Block 3: Enter current time and place an "X" in the "AM" or "PM" box.
- Block 4: Enter article's weight.
- Block 5: Place an "X" in the "3 PM" box.
- Block 6: Place an "X" in the "2nd Day" box.
- Block 7: Enter initials of clerk accepting article.
- Block 8: Enter the postage amount.
- Block 9: Enter the total postage.

To be completed by the customer:

- Block 10: Name and address of the mailer.
- Block 11: Name and address of the addressee.

After blocks 1-11 are completed, slide copies 2 and 3 from the label set. Provide the "CUSTOMER RECEIPT" to the mailer and turn in the "FINANCE COPY" to the Custodian of Postal Effects (COPE). Peel the protective backing from the label and attach it to the article.

**DISTRIBUTION OF LABEL 11-B**

- The Label 11-B copies are distributed as follows:
- COPY 1: Forwarded to the serving gateway USPS Express Mail Manager.
  - COPY 2: Forwarded to the serving gateway USPS Accounting Officer.
  - COPY 3: Given to the customer.
  - COPY 4: Addressee's copy.

**EXPRESS MAIL MILITARY SERVICE (EMMS) ACCOUNTING PROCEDURES**

All finance copies of Label 11-B retained by clerks during the day, are placed in an Express Mail envelope and addressed to the gateway USPS Accounting Office. The envelope containing the Label 11-Bs are mailed without applying postage by entering USPS Corporate Account #400 in the Federal Agency Code block on the Label 11-B.

**CUT-OFF TIME**

Each MPO authorized to accept Express Mail has a cut-off time. This is the deadline for accepting Express



mail addressed to ZIP Codes listed on the EMMS network that have a 2- or 3-day service standard. When mail is presented after the cut-off time for articles addressed to addresses that are on the network for 2-day delivery, the MPO clerk must inform the mailer that the article will be delivered by the third day. In this instance the accepting clerk must check the 3-day instead of the 2-day delivery block of Label 11-B. When a customer presents an Express Mail article for mailing after the cut-off time, and it is addressed to an address where there is only a 3-day delivery, the finance clerk should not accept the article. The clerk should ask the customer if they desire to come back on the next business day, or the customer can buy an Express Mail stamp. If the customer purchases an Express Mail stamp, the clerk must advise the customer to complete the Label 11-B, affix the label and stamp to the article, and deposit it in a collection box. On the next business day, a finance clerk will complete the date and time of acceptance blocks on the Label 11-B, cancel the Express Mail stamp with a flagstamp cancellation device, then remove and mail the customer's copy of Label 11-B to the mailer. Finance clerks must also consider weekends and holidays when accepting Express Mail to ensure Express Mail items accepted can be delivered within the 2- or 3-day service standard.

## FIRST-CLASS MAIL

---

**Learning Objective:** *Identify and process First-Class Mail.*

---

All mailable matter may be sent as First-Class Mail if the proper amount of postage is paid. In addition, the following items should only be mailed as First-Class Mail:

- Matter that is wholly or partially handwritten or typewritten.
- Matter that is closed against postal inspection. Material that is wrapped or packaged so that it cannot be examined easily or examined without destruction or serious damage should be considered closed against postal inspection and must be charged the applicable First-Class rate of postage.
- Other matter having the characteristics of actual and personal correspondence.

- Bills and statements of accounts. A bill is a request for payment of a definite sum of money claimed to be owed by the addressee either to the sender or to a third party.

## EXAMPLES OF FIRST-CLASS MATTER

Examples of material that must be mailed at the First-Class rate of postage include the following:

- Handwritten or typewritten matter, including identical copies prepared by automatic typewriter and manifold or carbon copies of such matter. Handwritten or typewritten matter does not include all matter produced by computers, but computer-prepared material is subject to the First-Class rate of postage if it has the character of actual and personal correspondence.
- Autograph albums containing writing.
- Notebooks or blank books containing written or typewritten entries or stenographic or shorthand notes.
- Blank printed forms filled out in writing, such as notices, certificates, and checks either canceled or uncanceled.
- Printed price lists containing written figures changing individual items.
- Printed cards or letters bearing a written date, where the date is not the date of the card but gives information as to when something will occur or has occurred.
- Any matter that contains the endorsement "POST CARD" or "DOUBLE POST CARD."

## Stamped Cards

A stamped card is a card sold by the USPS with a postage stamp printed or impressed on it, used for the transmission of messages. A double-stamped card consists of two attached stamped cards. Each card has printed or impressed thereon a postage stamp of the First-Class card rate, one of which may be detached by the receiver and returned by mail as a reply. Stamped cards may be requisitioned from the NPFO for sale at your customer service windows.

## Postcards

Postcards are privately printed mailing cards for the transmission of messages. They may be purchased

at many places of interest, motels, hotels, drugstores, and, of course, they are abundantly available at ports that your ship will visit overseas. The paper or card stock used for single and double postcards may be of any light color that does not prevent legible addresses and postmarks from being placed thereon. Cards with brilliant colors must not be used. Single postcards and each part of double postcards must conform to the following specifications to qualify for mailing at the card rate:

- Postcards must not be smaller than 3 1/2 by 5 inches nor larger than the size fixed by the Convention of the Universal Postal Union in effect (currently 4 1/4 by 6 inches).
- Postcards must be rectangular in shape.
- A postcard must be made of an unfolded and uncreased piece of paper or card stock of approximately the quality and weight of a stamped card. The thickness must be uniform and not less than 0.007 of an inch thick.

### **Use of Double- and Single-Stamped Cards and Postcards**

The users of double- and single-stamped cards and postcards must comply with the following rules:

- Double cards must be folded before mailing. The first half must be detached when the reply half is mailed for return.
- The reply half on a double card must be used for reply purposes only. It must not be used to convey a message to the original addressee of the double card nor to send statements of account.
- Double cards must be prepared so that the address on the reply half is on the inside when the double card is mailed.
- Plain stickers, or seals, or a single-wire stitch may be used to fasten the edges of double cards only if affixed so that the inner surfaces of the cards can be readily examined.
- Enclosures in double cards are prohibited.
- Cards bearing attachments are not mailable at the stamped card rate of postage. Labels affixed by adhesive to show the address and the return address are permitted.
- The face of the card must be divided vertically into a right side and a left side, with or without a vertical rule. The left portion is to be used for the

return address, and the right portion for the address, postage, and postal endorsements. (A space of at least 2 1/8 inches wide measured from the right edge of the card must be reserved.)

- Stamped cards and postcards that have holes or vertical tearing guides are mailable only if the holes and tearing guides do not result in the elimination of any letters or numbers in the address.

Matter in the form of a single or double card, but does not conform to the specifications for a single or double postcard as stated above, should not be mailed at the card rate. These cards are subject to postage at the First-Class rate.

### **FIRST-CLASS ZONE RATED (PRIORITY) MAIL**

Zone rated mail consists of First-Class Mail weighing more than 13 ounces and is referred to as priority mail. Priority mail provides the fastest mail service for heavy articles (with the exception of Express Mail). Any class of mail can be mailed at the priority rate of postage, if the customer is willing to pay for this service.

### **WEIGHT AND SIZE LIMITS**

At the time you accept an article for mailing, you must determine whether or not it meets the weight and size limitations. Articles mailed at the First-Class or priority rate of postage must not exceed 70 pounds in weight and 108 inches in length and girth combined. Remember that First-Class rates are computed differently for articles weighing 13 ounces or less and for those zone rated articles weighing over 13 ounces.

### **POSTAL ZONES**

First-Class zone rated (priority) rates are computed on the basis of weight of the individual piece and the distance it must travel. To administer these rates, the earth is considered to be divided into units of area 30 minutes square, identical with a quarter of the area formed by intersecting parallels of latitude and meridians of longitude. Each unit of area is designated by a number. The USPS has divided the U.S. and its territories into a local zone plus eight others. The postal zones are defined as follows:

- Local zone: The local zone applies to mail deposited at any post office for delivery to

addresses within the delivery area of that post office. This includes APOs or FPOs within its delivery limits. For various types of post offices, the local zone applies to all mail that both originates and reaches its destination within:

- a. The 5-digit ZIP Code area(s) assigned to the same post office.
  - b. Any of the 5-digit ZIP Codes that are part of any unique 3-digit ZIP Code prefix(es) or other separate 5-digit ZIP Code(s), as applicable, assigned to the same post office.
- Zone 1: Includes all territory within the quadrangle in conjunction with every contiguous quadrangle, representing an area with a mean radial distance of about 50 miles from the center of a given unit of area. The zone one rate applies to parcels mailed between two post offices in the same 3-digit ZIP Code area of dispatch.
  - Zone 2: Includes all units of area outside zone 1 lying in whole or in part within a radius of about 150 miles from the center of a given unit of area.
  - Zone 3: Includes all units of area outside zone 2 lying in whole or in part within a radius of about 300 miles from the center of a given unit of area.
  - Zone 4: Includes all units of area outside zone 3 lying in whole or in part within a radius of about 600 miles from the center of a given unit of area.
  - Zone 5: Includes all units of area outside zone 4 lying in whole or in part within a radius of about 1,000 miles from the center of a given unit of area.
  - Zone 6: Includes all units of area outside zone 5 lying in whole or in part within a radius of about 1,400 miles from the center of a given unit of area.
  - Zone 7: Includes all units of area outside zone 6 lying in whole or in part within a radius of about 1,800 miles from the center of a given unit of area.
  - Zone 8: Includes all units of area outside zone 7.

## OFFICIAL ZONE CHARTS

An official zone chart prepared for each sectional center facility is used to determine zones from all postal units within the sectional center area. The chart to be used by each MPO is identified by the inclusive

ZIP Codes assigned to postal units in the sectional center. MPOs use the official zone chart of their serving postmasters. At overseas military post offices postage is computed from the U.S. gateway (New York, San Francisco, or Miami) to the destination of the article mailed.

To determine the zone from the office of mailing to the office of address, refer to the zone chart in use at your post office. Figure 4-3 is the zone chart used at military post offices with an FPO AP mailing address.

## DETERMINING THE POSTAL ZONE

To find the zone number for any article, you should do the following:

- Identify the addressee's ZIP Code (example: 44118).
- Identify the ZIP Code prefix (the first three numbers). Example: The prefix number of 44118 is 441.
- Find the prefix number in range on the zone chart. Example: Using the chart in figure 4-3, you will see that 441 falls in the range of ZIP Code prefixes 388-499.
- Find the zone number to the right of the ZIP Code prefix. In this case the zone number for the ZIP Code prefix 441 is 8.

NOTE: Local zones are not indicated on the USPS official zone charts. You must determine the local zone.

## POSTAGE RATES

First-Class rates for articles weighing 13 ounces or less are computed on the basis of the weight of the individual piece. A certain amount is charged for the first ounce and a reduced rate for each succeeding ounce or a fraction thereof. A fraction of an ounce is charged the same rate as a full ounce. Example: A First-Class letter weighing 2 1/2 ounces would **currently cost:**

- First ounce: 33 cents
- Second ounce: 55 (additional 22) cents
- Third ounce: 77 (additional 22) cents

The letter in the example would cost 77 cents to mail.

3-digit ZIP Code prefix is <b>966</b> . The first 3-digits of your destination ZIP Code determine the zone. (* - Indicates zones eligible for Intra-BMC Rates)							
ZIP Code Prefix	Zone	ZIP Code Prefix	Zone	ZIP Code Prefix	Zone	ZIP Code Prefix	Zone
004..374	8	620..667	7	834..835	5	955	3*
375	7	668..672	6	836..837	4	956..959	2*
376..379	8	673	7	838	5	960..961	3*
380..381	7	674..693	6	840..844	4	962..966	1*
382..385	8	700..704	8	845	5	967..969	8
386..387	7	705..706	7	846..847	4	970..974	4
388..499	8	707..709	8	850..853	5	975..976	3
500..509	7	710..729	7	854	4	977..979	4
510..511	6	730..732	6	855..859	5	980..985	5
512..528	7	733	7	860..864	4	986	4
530..534	8	734..739	6	865..880	5	987	1
535..540	7	740..745	7	881..882	6	988..992	5
541..543	8	746	6	883	5	993	4
544..567	7	747..762	7	884	6	994	5
570..577	6	763	6	885	5	995..997	8
580..582	7	764..767	7	889..893	4	998	7
583..588	6	768..769	6	894..897	3*	999	6
590..591	5	770..787	7	898..929	4		
592..593	6	788	6	930..935	3		
594..599	5	789	7	936..939	2*		
600..609	8	790..797	6	940..941	1*		
610..617	7	798..832	5	942	2*		
618..619	8	833	4	943..954	1*		

AOF0403

Figure 4-3.—Official zone chart used by military post offices from Pacific commands.

Notice that after the first ounce, each additional ounce increases in price by 22 cents. The prices indicated in this NRTC may not accurately reflect the current postage rates charged by the USPS. **Refer to Module R of the DMM for current postage rates.**

**FIRST-CLASS ZONE RATES**

The postage rate for First-Class articles that weigh more than 13 ounces is based on the weight of the individual article and the distance the articles must travel. Look at the rate chart in table 4-3. The rates in this chart are used to determine the cost of mailing articles weighing more than 13 ounces. The top of the chart shows the eight zones. Note that the rates for local and zones 1, 2 and 3 are the same. The column on the left side of the chart shows the pounds up to and including 70 pounds. If an article weighs in between the listed pounds on the zone chart postage is charged for the next pound. Example: an article that weighs 3 pounds 2 ounces would be charged the rate for 4 pounds. The six columns below the zones and to the

right of the weight column is the amount of postage that will be charged depending on the zone of delivery.

The distance between the office of mailing and the city of address determines the zone number. The city of mailing for all MPOs is the city of your official mailing address (AA-Miami, AE-New York, or AP-San Francisco) regardless of location. The local zone rate should always be charged when articles are mailed between MPOs if the articles do not transit the 48 contiguous states or are not handled by USPS personnel. The local zone rate is charged in these circumstances because transportation charges are totally paid by the military department concerned. The local zone rate of postage should be charged if an article is mailed:

From an MPO to the city of the serving postmaster (for example, FPO AA 34099 to the city of Miami).

From one MPO to another MPO with the same serving postmaster; that is, FPO AP 96347 (Yokohama, Japan) to a ship with a FPO AP 96697 address.

Table 4-3.—First-Class zone rated (Priority) mail chart.

PRIORITY MAIL													
Weight Not Over (pounds) <sup>1</sup>	Zone						Weight Not Over (pounds) <sup>1</sup>	Zone					
	L, 1, 2, & 3	4	5	6	7	8		L, 1, 2, & 3	4	5	6	7	8
1	\$3.20	\$3.20	\$3.20	\$3.20	\$3.20	\$3.20	39	17.30	26.90	31.05	37.75	42.05	51.25
2 <sup>2</sup>	3.20	3.20	3.20	3.20	3.20	3.20	40	17.70	27.55	31.80	38.65	43.10	52.45
3	4.30	4.30	4.30	4.30	4.30	4.30	41	18.00	28.15	32.50	39.55	44.10	53.65
4	5.40	5.40	5.40	5.40	5.40	5.40	42	18.40	28.80	33.25	40.45	45.15	54.85
5	6.50	6.50	6.50	6.50	6.50	6.50	43	18.80	29.45	34.00	41.40	46.15	56.10
6	6.60	6.90	7.10	7.45	7.70	8.25	44	19.15	30.05	34.75	42.30	47.20	57.35
7	6.70	7.30	7.70	8.40	8.90	10.00	45	19.50	30.70	35.50	43.20	48.20	58.55
8	6.80	7.70	8.30	9.35	10.10	11.75	46	19.85	31.35	36.20	44.10	49.20	59.75
9	6.90	8.10	8.90	10.30	11.30	13.50	47	20.25	31.95	36.95	45.05	50.25	60.95
10	7.00	8.50	9.50	11.25	12.50	15.25	48	20.60	32.60	37.70	45.95	51.25	62.15
11	7.20	9.15	10.30	12.20	13.45	16.50	49	20.95	33.25	38.45	46.85	52.30	63.35
12	7.40	9.80	11.05	13.10	14.45	17.80	50	21.35	33.85	39.20	47.75	53.30	64.55
13	7.75	10.40	11.80	14.05	15.50	19.10	51	21.70	34.50	39.90	48.65	54.25	65.80
14	8.10	11.05	12.55	14.95	16.50	20.40	52	22.05	35.15	40.65	49.60	55.30	67.00
15	8.50	11.70	13.30	15.85	17.50	21.70	53	22.45	35.75	41.40	50.50	56.25	68.20
16	8.85	12.30	14.00	16.75	18.55	23.00	54	22.80	36.40	42.15	51.40	57.25	69.40
17	9.20	12.95	14.75	17.70	19.55	24.30	55	23.15	37.05	42.90	52.30	58.20	70.60
18	9.60	13.60	15.50	18.60	20.60	25.60	56	23.55	37.65	43.60	53.25	59.20	71.80
19	9.95	14.20	16.25	19.50	21.60	26.95	57	23.90	38.30	44.35	54.15	60.20	73.05
20	10.35	14.85	17.00	20.40	22.65	28.20	58	24.25	38.95	45.10	55.05	61.15	74.25
21	10.70	15.50	17.70	21.35	23.65	29.45	59	24.65	39.55	45.85	55.95	62.20	75.45
22	11.05	16.15	18.45	22.25	24.70	30.65	60	25.00	40.20	46.60	56.90	63.15	76.65
23	11.45	16.75	19.20	23.15	25.70	31.85	61	25.35	40.85	47.30	57.80	64.15	77.90
24	11.75	17.40	19.95	24.05	26.70	33.05	62	25.75	41.45	48.05	58.70	65.10	79.10
25	12.15	18.05	20.70	25.00	27.75	34.35	63	26.10	42.10	48.80	59.60	66.10	80.35
26	12.55	18.65	21.40	25.90	28.75	35.55	64	26.50	42.75	49.55	60.55	67.10	81.55
27	12.90	19.30	22.15	26.80	29.80	36.75	65	26.85	43.35	50.25	61.45	68.05	82.75
28	13.25	19.95	22.90	27.70	30.80	37.95	66	27.20	44.00	51.00	62.35	69.10	83.95
29	13.65	20.55	23.65	28.60	31.85	39.15	67	27.60	44.65	51.75	63.25	70.05	85.15
30	14.00	21.20	24.40	29.55	32.85	40.35	68	27.95	45.25	52.50	64.15	71.00	86.35
31	14.35	21.85	25.10	30.45	33.90	41.55	69	28.30	45.90	53.25	65.10	72.05	87.55
32	14.75	22.45	25.85	31.35	34.90	42.80	70	28.70	46.55	53.95	66.00	73.00	88.80
33	15.10	23.10	26.60	32.25	35.95	44.00							
34	15.45	23.70	27.35	33.15	36.95	45.20							
35	15.80	24.35	28.10	34.10	37.95	46.40							
36	16.20	25.00	28.80	35.00	39.00	47.60							
37	16.60	25.65	29.55	35.90	40.00	48.80							
38	16.90	26.25	30.30	36.85	41.05	50.05							

1 Parcels that weigh less than 15 pounds but measure more than 84 inches in combined length and girth are charged the applicable rate for a 15-pound parcel.  
 2 The 2-pound rate is charged for matter sent in a flat-rate envelope provided by the USPS, regardless of the actual weight of the piece.

From one MPO to another MPO with a different serving postmaster provided the article does not transit the 48 contiguous states; that is, FPO AP 96349 (Yokosuka, Japan) to FPO AE 09834 (Bahrain).

From FPO AE 09619 (Naples, Italy) to a ship with an FPO AA 34090 address operating in the Mediterranean area.

When a customer presents an article for mailing at your overseas MPO addressed to a ship served by a different postmaster, you should verify if the ship is operating in your overseas area or is in the U.S. You should always give the customer the best service possible at the lowest rate of postage and be familiar with the no-cost intra-theater delivery service (IDS) that is discussed later in chapter 9.

## TWO OR MORE PACKAGES

Two or more packages may be mailed as a single package if the packages are about the same size or shape, or they are an integral part of one article. The packages must be securely wrapped or fastened together and must not, together, exceed the maximum weight or size limits.

## BALLOON SURCHARGE

The balloon surcharge must be assessed on a priority mail or parcel post item if both of the following apply:

- The weight is less than 15 pounds.

- The combined length and girth is from 84 to 108 inches.

These articles must be charged the 15-pound rate for the appropriate zone.

## ENDORSEMENTS

An endorsement is a marking on mail that shows the rate of postage charged and any additional service the mail is to receive. Mark all endorsements with a rubber handstamp. First-Class endorsements are required on large envelopes and small parcels weighing less than 13 ounces. Endorsements for standard size First-Class letters are not required.

Place the endorsement on the address side between the “delivery address” and the “postage.” Endorse all articles sent at the priority rate by affixing USPS Label 106 (Priority Mail Strip), 106-A (Priority Mail Tape) or 107 (Priority Mail Sticker). If the size of the article(s) being mailed prohibit use of the labels you can use a Priority, or Priority Mail rubber handstamp to apply the endorsement. See figures 4-4 and 4-5.

## CANCELING THE STAMPS

One of the last things you will do in processing an article is cancel the stamps. Cancel all stamps using a bar canceler (Killer Bars) or a machine canceler. Always cancel stamps with black ink to prevent reuse.

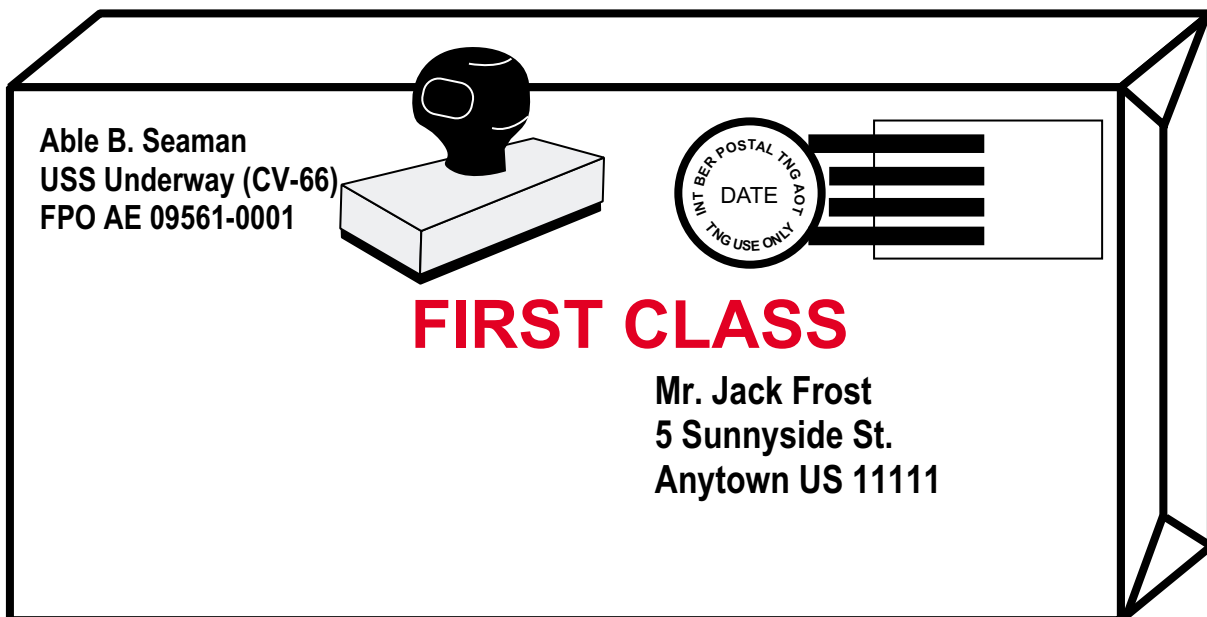

PCF0404

Figure 4-4—Endorsement on a First-Class article.

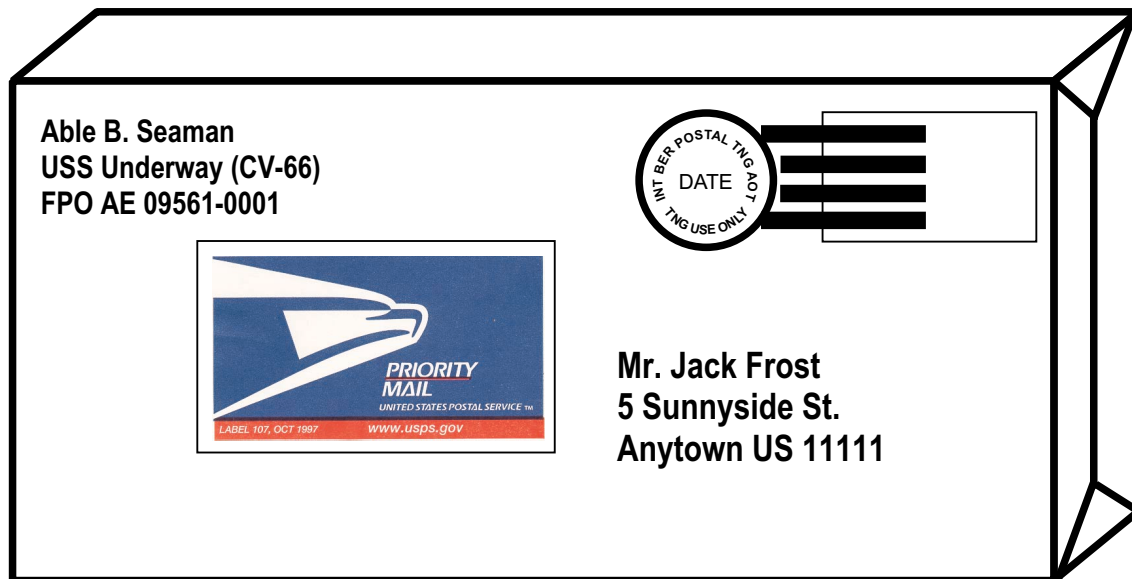

PCF0405

Figure 4-5.—Endorsement on a Priority Mail article.

- Q4-1. *What is the definition of domestic mail as stated in the Domestic Mail Manual?*
- Q4-2. *List the factors that determine the different classes of mail.*
- Q4-3. *Domestic mail is divided into what five classes of mail?*
- Q4-4. *If an article being presented for mailing is not square or rectangular in shape, at what part of this article should the measurements be taken?*
- Q4-5. *Express Mail service is available at all MPOs? (True/False.)*
- Q4-6. *What document is used to send Express Mail via post office to addressee?*
- Q4-7. *A privately printed post card is considered to be what class of mail?*
- Q4-8. *What is the minimum size limit for a post card?*
- Q4-9. *Define First-Class zone rated (Priority) mail.*
- Q4-10. *First-Class zone rated (Priority) mail must not exceed what maximum weight limit?*
- Q4-11. *What is the maximum combined length and girth of a First-Class zone rated (Priority) parcel that may be accepted in the mail?*
- Q4-12. *The USPS has divided the U.S. and its territories into how many zones?*
- Q4-13. *Explain the Balloon Surcharge*

Now turn to appendix 1 to check your answers.

## PERIODICALS

---

**Learning Objective:** *Recall the makeup of Periodical mail.*

---

Periodicals are publications such as magazines and newspapers whose primary purpose is transmitting information to an established list of subscribers or requesters. Webster dictionary defines periodicals as *publications published at regular intervals of more than one day*. Only publishers and registered newsagents authorized periodicals mailing privileges may mail at the Periodicals rate.

### WHAT MAY BE MAILED AT THE PERIODICALS RATES

Periodical matter consists of complete magazines, newspapers and other periodicals (the term *complete*, means in the same manner the publication was published). A cutout page of a magazine or a portion of a newspaper is not considered periodicals matter. Based on their weight, they'll be considered standard mail matter.

### PERIODICALS MAILED BY THE GENERAL PUBLIC

As a military postal clerk, you need only be concerned with newspapers and other periodicals mailed by the general public (persons other than publishers or registered newsagents). These articles, which have previously been entered into the USPS at the Periodicals rate, will be charged the applicable

Standard Mail (B) rate. If the mailer wants the article to get to the addressee faster, it must be sent at the First-Class or priority rate, depending on the weight.

## STANDARD MAIL

---

**Learning Objective:** *Identify the different types of Standard Mail.*

---

Standard Mail is broken down into two classes, Standard Mail (A) (presorted mail) and Standard Mail (B). As a military postal clerk, you will only be concerned with Standard Mail (B) while conducting customer service at your post office finance window.

### STANDARD MAIL (B)

Standard Mail (B) includes parcel post, special standard mail (B), and library mail. At MPOs, Standard Mail (B) is commonly known as Space Available Mail (**SAM**) mail. Standard Mail (B) includes all mailable merchandise, printed matter, and all other matter not included in the First-Class category.

Standard Mail (B) is given air service to the U.S. and between MPOs overseas. Customers frequently refer to Standard Mail (B) as the “**CHEAPEST WAY.**” When a customer wants to mail an article the “**CHEAPEST WAY,**” look at the contents to determine if First-Class matter (other than authorized enclosures) are included in the article. If not, then mail it as Standard Mail (B).

### Preparation

The delivery address on all articles sent as Standard Mail (B) should include a complete mailing address with ZIP Code, and the complete return address of the sender. Standard Mail (B) mail must be wrapped or packaged so that it can be easily examined. Standard Mail (B) mail is not sealed against inspection. Articles mailed at the Standard Mail (B) rate of postage may be subject to inspection under certain conditions whether or not the mail piece is secured.

### Enclosures and Additions

The following examples of written additions and enclosures do not require First-Class postage when

placed in or on a parcel mailed at the Standard Mail (B) rate:

- Marks to call attention to words or passages in the text of the publication.
- Standard Mail (A) printed matter.
- Marks, numbers, names, or letters describing the contents.
- Words or phrases such as “Do Not Open Until Christmas” and “Happy Birthday, Mother,” and similar inscriptions on the package, wrapper, or envelope, or on an attached tag or label.
- Instructions and directions for the use of the item mailed.

For further information on written additions, refer to Module E of the DMM.

### Weight and Size Limits

The maximum weight limit for Standard Mail (B) is 70 pounds. However, mail being sent to APOs/FPOs overseas must meet the applicable standards listed in the USPS Postal Bulletin (Conditions Applied to Mail Addressed to Military Post Offices Overseas).

The maximum size limit for mail sent at the Standard Mail (B) rate of postage is 108 inches in length and girth combined. The exception being Parcel Post (**Oversized Mail**), which may be 130 inches (charged the applicable oversized rate). Articles measuring over 84 inches in length and girth combined weighing less than 15 pounds fall under the 15-pound rule mentioned earlier in this chapter.

### Rates

Like priority mail, postage for Standard Mail (B) is determined by the weight of the parcel and the distance it must travel. The greater the distance a parcel must travel and the more it weighs, the higher the mailing cost. For determining the weight, use your scale. Always remember when computing the postage for an article to be mailed at the Standard Mail (B) rate that a fraction of a pound is considered a full pound. Example: A parcel that weighs 6 pounds and 4 ounces would be charged the rate for 7 pounds.

Use the official zone chart that is applicable to your serving postmaster to determine the zone rate of postage to charge. There are two additional steps that must be taken when postage is computed for Standard Mail (B). You must determine if the article is



intra-BMC or inter-BMC and whether it is machinable or nonmachinable, which is discussed below.

### **Serving Bulk Mail Centers (BMCs)**

Once you have determined the weight and zone of destination, you must also determine if the article is within the delivery area of your serving bulk mail center (which is intra-BMC) or outside your bulk mail center (which is inter-BMC). The ZIP Code in the address of the article presented for mailing is used to determine the postal zone, and whether or not the article is intra-BMC or inter-BMC. Using the first three digits of the ZIP Code, refer to the bottom of your USPS official zone chart (figure 4-3). If the first three digits of the ZIP Code match those listed, the article is within the delivery area of your serving BMC.

### **Nonmachinable (Outside Mail)**

If an article presented for mailing is determined to be outside the delivery area of your serving BMC, you must then determine if the article can be handled by machine (machinable) or must be physically handled by sorting personnel (nonmachinable). If an article is defined by one or more of the following characteristics, it is nonmachinable and is processed as outside mail (not sackable).

- It is more than 34 inches long, 17 inches wide, or 17 inches high, or weighing more than 35 pounds.
- It contains more than 24 ounces of fluid in glass containers, or 1 gallon or more of liquid in metal or plastic containers.
- It is not wrapped properly or is metal-banded.
- It is a can, roll, or tube, or wooden or metal box.
- It is a shrub or tree.
- It contains perishables, such as eggs.
- It contains books, printed matter, or business forms weighing more than 25 pounds.
- It is a high-density parcel weighing more than 15 pounds, exerting more than 60 pounds per square foot pressure on its smallest side.

### **Within (Intra-BMC) BMC Discount**

If the article is addressed for delivery within the delivery area of your serving BMC, then you would

charge the Standard Mail (B) rate with a discount using the current rate chart listed in Module R of the DMM.

### **Machinable/Nonmachinable Inter-BMC Mail**

If an article is addressed for delivery outside the delivery area of your serving BMC (inter-BMC) and the article is determined to be machinable, then the no-discount, no-surcharge rate applies. On the other hand, if an article is addressed for delivery outside the delivery area of your serving BMC and the article is determined to be nonmachinable, the applicable rate plus the surcharge applies. However, if a special handling fee is paid, the nonmachinable surcharge is not to be charged.

### **Nonmachinable Surcharge**

The nonmachinable surcharge must be assessed on inter-BMC parcel post without special handling if any of the following apply:

- The length exceeds 34 inches.
- The height exceeds 17 inches.
- The width exceeds 17 inches.
- The weight exceeds 35 pounds.
- The packaging or contents are among those listed in Module E of the DMM.

### **Oversized Surcharge**

The oversize surcharge must be assessed on a parcel post article if the combined length and girth falls between 108 and 130 inches.

Parcel post is the only mail class that accepts articles with a combined length and girth over 108 inches. The oversized rate for the appropriate zone must be charged for these articles. The oversized rate is higher than the 70-pound rate, however the weight limit remains 70 pounds.

### **Endorsements for Standard Mail (B)**

Endorse Standard Mail (B) as “S A M” and “STANDARD MAIL (B)” on the address side of the article (see figure 4-6). SAM is given air service from the point of embarkation overseas to the point of entry into the U.S. Once SAM arrives at the point of entry in the Continental United States (CONUS), it is transported via surface (truck or rail) to its final destination.

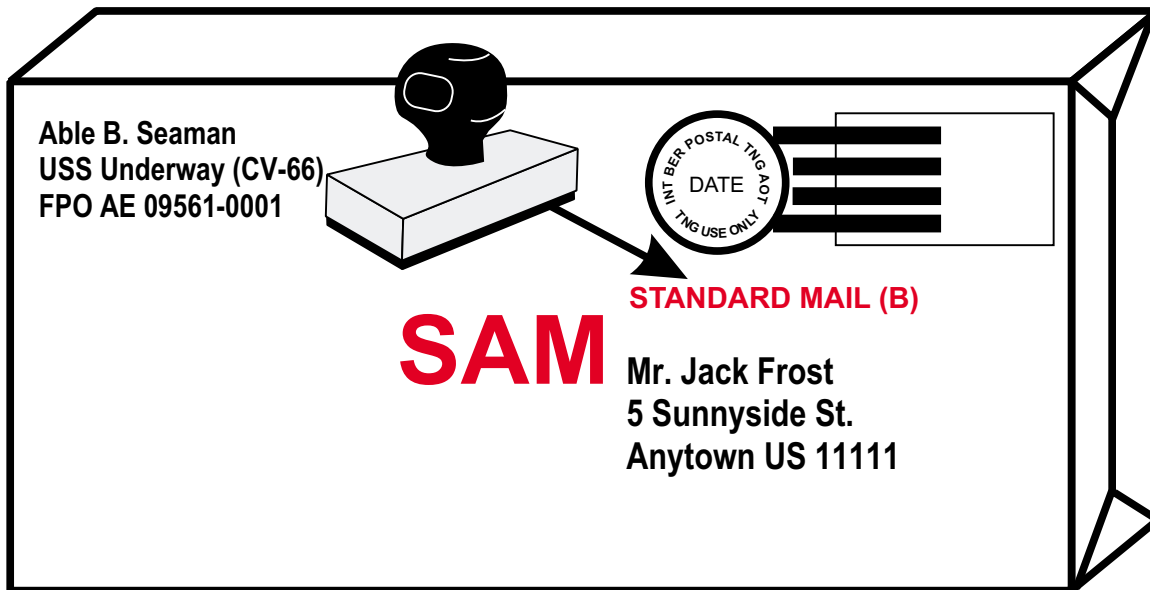

PCF0406

Figure 4-6—Endorsement on a Standard Mail (B) article.

### Attached Letters

Occasionally, a parcel may be presented for mailing at the Standard Mail (B) rate with a letter or other First-Class Mail attached. This is legal as long as the envelope is placed on the address side of the parcel. The name and the address of the sender and the name and address of the addressee should be placed on both the parcel and the envelope. If both names and addresses do not appear on both pieces, the sender's name and address must be placed on either the parcel or envelope and the name and address of the addressee must be placed on the other piece (see figure 4-7). Postage at the First-Class rate must be paid for and affixed to the attached letter. The attached envelope may be marked First-Class.

### Enclosed Letters

Normally, when mail of a higher class is enclosed with mail of a lower class, the rate of postage charged for the entire piece or parcel is that of the higher class. However, letters (First-Class Mail) may be enclosed in Standard Mail (B) parcels subject to the following conditions:

- Postage at the First-Class rate must be paid for each letter.
- The letter(s) is/are placed on top of other items in the parcel when practical.
- The total amount of postage for each letter is placed on the outside of the parcel.

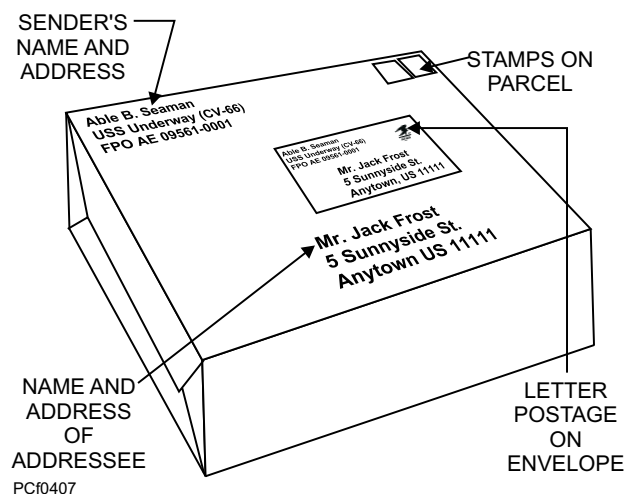

PCF0407

Figure 4-7.—How to affix a First-Class letter to a parcel.

The postage for the letter(s) may be added to that of the parcel and the total amount paid together, or the postage for the letter(s) may be affixed separately from the postage for the parcel. The endorsement **FIRST-CLASS MAIL ENCLOSED** must be placed on the parcel below the postage and above the address.

### SPACE AVAILABLE MAIL (SAM)

Parcels mailed at the surface postage rates, are airlifted to, from, or between overseas military post offices outside the 48 contiguous states. These parcels must be marked "SAM" on the address side, below the postage and above the addressee's name. These maximum weight and size limits apply when mailed from:

- The 48 contiguous states: 15 pounds, 60 inches in length and girth combined.
- An APO/FPO outside the 48 contiguous states: 70 pounds, 100 inches in length and girth combined.

### PARCEL AIRLIFT (PAL)

Parcel airlift service provides for air transportation of parcels on a space-available basis to or from military post offices outside the contiguous 48 states. PAL service is available for articles sent as Standard Mail (B) that are mailed at or addressed to any overseas post offices outside the 48 contiguous states.

PAL is given air service from the point of loading overseas to the point of entry into the U.S. on a space-available basis. Unlike SAM, PAL provides for continued air service from the point of entry into the U.S. to the city of address or to the nearest point where air service is available.

### Weight and Size Limits

For Standard Mail (B) to be given PAL service, certain weight and size requirements must be met.

- The article must not exceed 60 inches in length and girth combined.
- The article must not weigh more than 30 pounds.

### Postage Fees

To receive PAL service, the customer pays a fee in addition to the Standard Mail (B) rate of postage. The PAL fee is determined on the basis of the following weight increments:

- Not more than 2 pounds.
- Over 2 but not more than 3 pounds.
- Over 3 but not more than 4 pounds.
- Over 4 pounds.

The current PAL fees are found in Module R of the DMM.

### Endorsements

Articles sent PAL will be endorsed with the large letters “PAL” on the address side, above the name of the addressee (see figure 4-8.) It is the responsibility of the accepting clerk to place the “PAL” endorsement on the article at the time of acceptance.

### SPECIAL STANDARD MAIL

This is a special rate of postage for certain items of Standard Mail. In most instances, this rate is cheaper than the Standard Mail (B) rate. Both rates should always be checked to ensure that the cheapest rate is applied. Some of the articles that may be mailed at the Special Standard Mail rate include:

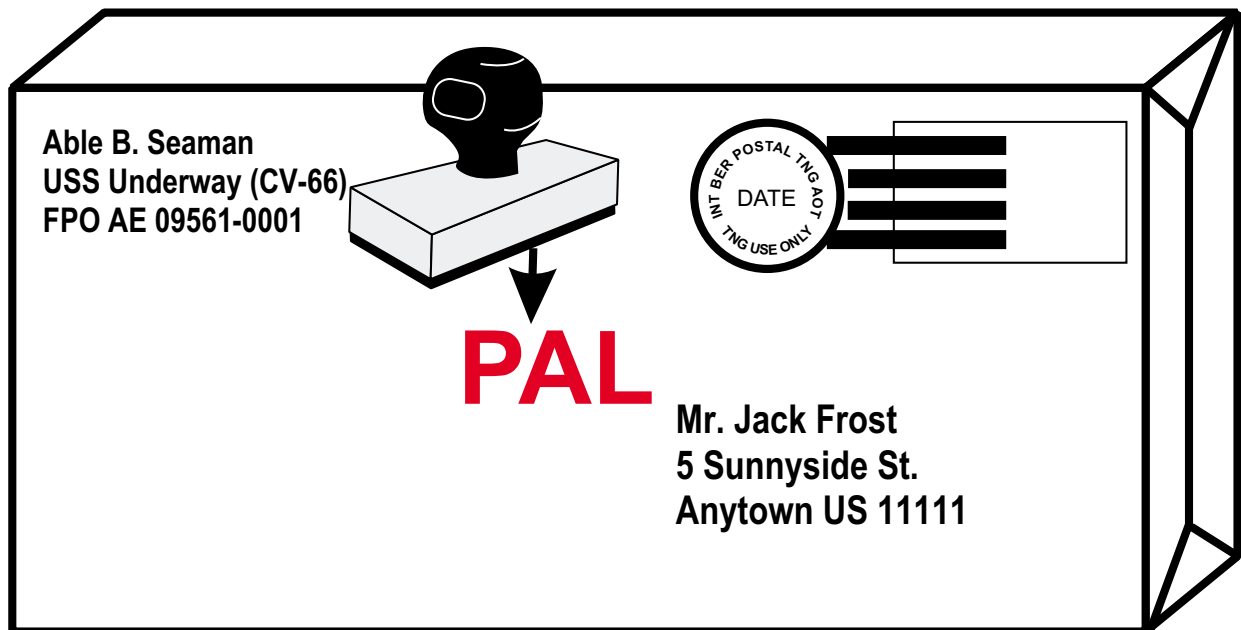

PCF0408

Figure 4-8—Endorsement on a PAL article.

- Books
- Film and microfilm (16 millimeter)
- Test materials
- Printed music
- All sound recordings (records, video/audio cassettes, reel to reel tapes, and compact discs)
- Manuscripts for books

Refer to Module R of the DMM for the postage rate chart for Special Standard Mail. Special Standard Mail rates are based solely on the weight of the article, without regard to zone. PAL service may be applied to Special Standard Mail articles, if customers request the service.

Endorse these articles as “SPECIAL STANDARD MAIL” and “SAM” or “PAL” if the customer paid for this service. This endorsement should be rubber stamped on the address side of articles as shown in figure 4-9.

## LIBRARY MAIL

Library Mail is Standard Mail matter that meets the Standard Mail mailing requirements. Library Mail rates are based on the weight of the piece, without regard to zone. This service is usually cheaper than Standard Mail (B) parcel post rates, but should always be compared. Some of the articles mailable at the Library Mail rate are:

- Books

- Printed music
- Sound recordings (records, video/audio cassette tapes, reel to reel tapes, and compact discs)
- 16-millimeter film
- Manuscripts for books

Refer to Module R of the DMM for the most current postage rate chart.

You should remember one very important item when dealing with the Library Mail rate. The article **MUST** be sent “BETWEEN,” “TO,” or “FROM” a school, college, university, public library, museum, or other nonprofit institution. Each piece must show in the delivery or return address the name of one of the organizations listed above.

Endorse these articles as “LIBRARY MAIL” and “SAM.” This endorsement should be rubber stamped on the address side of the articles as shown in figure 4-10. PAL service may also be applied to library rate parcels.

*Q4-14. What does Periodicals matter consist of?*

*Q4-15. What class of mail is often referred to as the cheapest way?*

*Q4-16. As a minimum, what addressing information is required on a Standard Mail (B) parcel?*

*Q4-17. What is the maximum weight limit for Standard Mail (B)?*

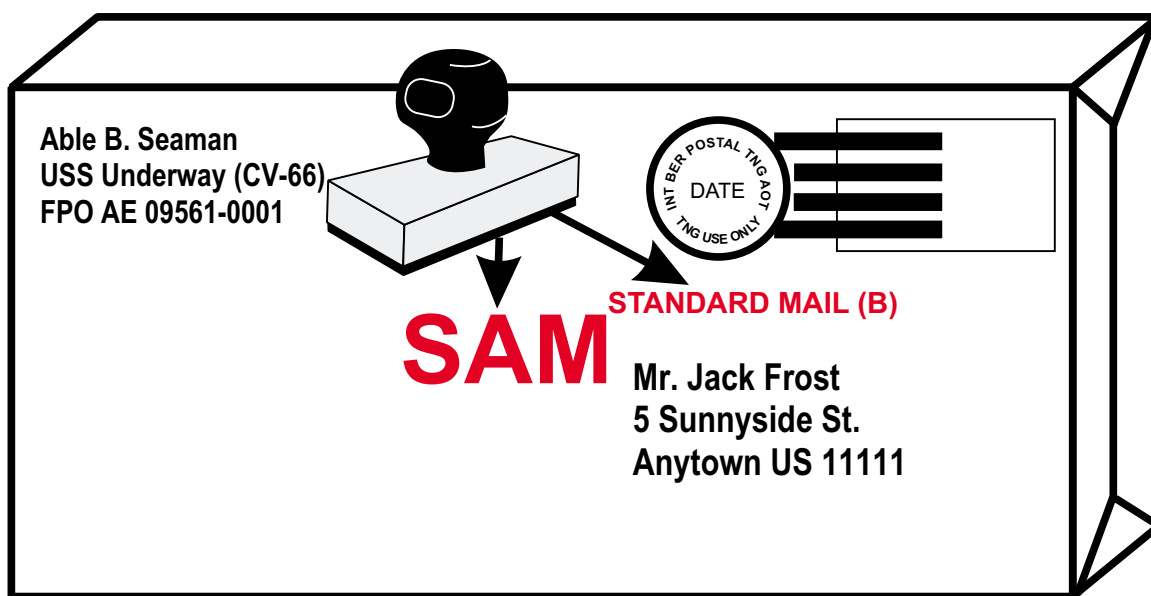

PCf0409

Figure 4-9—Endorsement on a Special Standard Mail article.

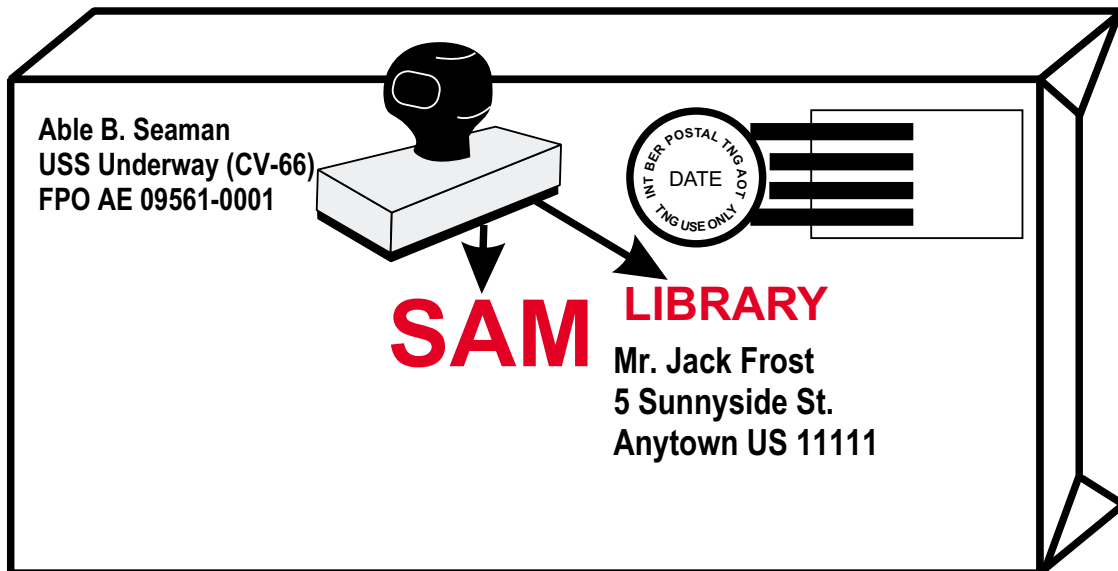

PC0410

Figure 4-10—Endorsement on a Library Mail article.

- Q4-18. Before accepting a Standard Mail (B) parcel addressed to a military post office overseas, what publication should you consult?
- Q4-19. What is the maximum size limitation for Standard Mail (B)?
- Q4-20. A parcel presented for mailing is determined to be outside your serving BMC. To compute the proper postage, what factor must you consider?
- Q4-21. When a parcel presented for mailing is determined to be within your serving BMC (intra-BMC), what compensation is made?
- Q4-22. Name at least three items that may be mailed at the Special Standard Mail rate.
- Q4-23. What endorsements should be placed on articles mailed at the Special Standard Mail rate, and in what location?

Now turn to appendix 1 to check your answers.

## CUSTOMS PROCEDURES FOR DOMESTIC MAIL

**Learning Objective:** Recall the customs requirements for Domestic Mail.

All articles mailed from an MPO outside the Customs Territory of the United States (CTUS) believed to contain merchandise are subject to customs examination and duty collection upon entry into the U.S. customs territory.

The CTUS includes the 50 states, District of Columbia (Washington, DC), and Puerto Rico. Merchandise mailed outside of these areas and to these areas must have a customs declaration attached. It is the mailer's responsibility when mailing items to or from areas outside the CTUS to comply with customs laws. In other words, the mailer must accurately list the contents and value of each article mailed. However, you, as a military postal clerk, should check for the following items at the time an article containing merchandise is presented for mailing:

- The proper customs form is properly completed and attached.
- The mailer has a valid identification card.

## CUSTOMS DECLARATIONS

Two types of customs declaration forms are available, PS Form 2976, CN 22 (Old C 1), and PS Form 2976-A, Customs Declaration and Dispatch Note. Letter mail and parcels containing merchandise addressed for delivery within the CTUS must have a customs form attached.

**NOTE:** After the mailer and accepting clerk completes PS Form 2976-A, the accepting clerk must insert the form set into an envelope (PS Form 2976-E).

Either a PS Form 2976 (see figure 4-12) or PS Form 2976-A (see figure 4-13) may be used, provided they are completed properly, and lists and describes the entire contents of the article. The class of mail does NOT determine which customs form to use. However,

as a general guide, PS Form 2976 should be used on letter mail containing merchandise and parcels too small to accommodate the larger PS Form 2976-A.

When the sender prefers not to show the nature of the contents on the outside of the article, or when the value of the contents exceeds \$400, the sender must prepare and enclose in the package a completed PS Form 2976-A. Then the customer must affix only the

upper portion of the PS Form 2976 to the address side of the article (cut on dotted line and discard lower portion) and give the MPO the post office copy of the detached PS Form 2976 for their files. See figure 4-11.

Customs duty is sometimes improperly assessed on articles entering the U.S. because of misleading, incomplete, or inaccurate information listed on the customs declaration. This problem could normally

United States Postal Service <b>Customs Declaration and Dispatch Note</b>		 CP193863656US		
Sender's Name and address (Nom et adresse de l'expéditeur) <b>Able B. Seaman USS Underway (CV-66) FPO AE 09561-0001</b>		Addressee's Name and address (Nom et adresse du destinataire) <b>Mr. Jack Frost 5 Sunnyside St. Anytown US 11111</b>		
List of Contents (Désignation du contenu) Please Print <b>Static Radio -USA Cassette tapes pair of headphones</b>		Qty.	Value (Valeur)	Net Weight (Poids net)
		1	\$80.00	
		10	\$50.00	
		1	\$25.00	
Insured No.	Insured Amount	SDR Insured Value	Postage US \$ <b>\$6.34</b>	Gross Weight <b>14 lb 8 oz</b>
Check One: <input type="checkbox"/> Commercial Sample (Echantillon commercial)		<input type="checkbox"/> Documents	<input checked="" type="checkbox"/> Gift (Cadeau)	<input type="checkbox"/> Merchandise
Sender's Instructions in Case of Nondelivery (Instructions de l'expéditeur en cas de non-livraison) <input checked="" type="checkbox"/> Return to Sender (Renvoyer à l'origine) NOTE: Item subject to return charges at sender's expense. <input type="checkbox"/> Abandon (Abandonner) <input type="checkbox"/> Redirect to Address Below (Réexpédier à):		Sender's Signature and Date (Signature de l'expéditeur et date) <i>Able B. Seaman</i> 3 Mar 95 I certify that the particulars given in the customs declaration are correct and that this item does not contain any dangerous article prohibited by postal regulations.		
PS Form <b>2976-A</b> , May 1996 Do not duplicate form without USPS approval. 1025950-00-8-0000		Copy 1 - Customs Declaration		

**PLACE INSIDE THE PARCEL**

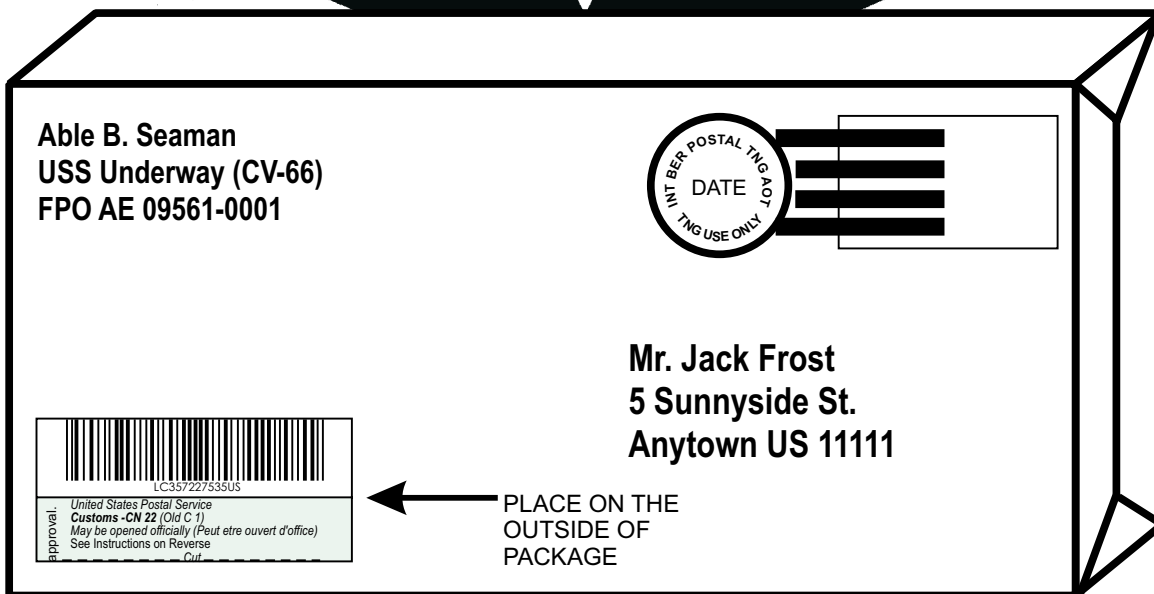

**PLACE ON THE  
OUTSIDE OF  
PACKAGE**

PCF0411

Figure 4-11—Customer not declaring contents on the outside of the article.

have been avoided if the customs declaration was more closely checked by the accepting clerk. Some of the most common errors are as follows:

- Mailing of used personal effects without indicating so on the customs form.
- Failure to indicate that the merchandise is of U.S. origin.
- Failure to indicate that the material was taken overseas after having previously been in the owner's possession in the U.S.

Proper completion of customs declaration forms will also ensure that parcels move through customs with a minimum of delay.

### PS Form 2976

The following instructions, explain how to properly complete PS Form 2976 (see figure 4-12).

Block 1: Sender enters a detailed description of the contents. This includes quantity, material an article is made of such as cotton, leather, silk, etc., brand names, and whether the article(s) are new or used.

Block 2: The sender enters the dollar value of each article and totals it.

Block 3: The accepting clerk enters the weight of the article expressed in pounds and ounces.

Block 4: The sender marks with an "X" to indicate the type of contents.

Block 5: The sender signs the customs declaration form.

Block 6: The sender enters their name and address, the name and address of the addressee, then signs and dates.

NOTE: The MPO maintains the detached PS Form 2976 at the post office for 30 days.

### PS Form 2976-A

The following instructions are to be used to properly complete PS Form 2976-A (see figure 4-13).

Block 1: Sender enters name and address, just as they appear on the article being mailed.

Block 2: Sender enters the addressee's name and address, just as they appear on the article being mailed.

Block 3: Sender enters a detailed description of the contents (model, make, brand names, new or used, and country of manufacture). The sender must also include the quantity and value for each item. Enter the net weight of each item, if known.

Block 4: Sender marks with an "X" to indicate the type of content.

Block 5: Sender marks with an "X" to indicate proper disposition in case the article is undeliverable.

Block 6: Sender signs and dates the customs declaration.

Block 7: Accepting clerk completes this block only when numbered insurance service is requested. Enter the insured number from the customer's receipt.

Block 8: Accepting clerk completes this block only when insurance service is requested. Enter the insured dollar amount.

Block 9: Leave the "SDR Insured Value" block blank.

Block 10: Accepting clerk enters only the postage, no fees.

Block 11: Accepting clerk enters the article's weight expressed in pounds and ounces.

 LC357227549US		LC357227549US	
United States Postal Service Customs - CN 22 (Old C 1) May be opened customarily (Post does convert articles) See instructions on Flapcover		<b>Customs - CN 22 (Old C 1) Sender's Declaration</b> I certify that the particulars given in the customs declaration are correct and that this item does not contain any dangerous article prohibited by postal regulations. This copy will be retained at the post office for 30 days.	
Do not duplicate without USPS approval.	Detailed Description of Contents (1)	Value (US \$)	Sender's Name & Address (Nom et adress de l'expéditeur)
	Weight (Poids) (3)	Total (2)	
	<input type="checkbox"/> Gift (4) <input type="checkbox"/> Merchandise (Marchandises) <input type="checkbox"/> Commercial Sample		
	I certify that this merchandise does not contain any dangerous article prohibited by postal regulations. (5)		
	Signature		
PS Form 2976, June 1997    CN 22 (Old C 1)		Detached from PS Form 2976, June 1997    Post Office Copy	

PC10412

Figure 4-12—PS Form 2976, Customs - CN22.

United States Postal Service <b>Customs Declaration and Dispatch Note</b>		 CP4 70059423US		
Sender's Name and Address ( <i>Nom et adresse de l'expéditeur</i> )  <div style="text-align: center;">①</div>		Addressee's Name and Address ( <i>Nom et adresse du destinataire</i> )  <div style="text-align: center;">②</div>		
List of Contents ( <i>Désignation du contenu</i> ) Please Print  <div style="text-align: center;">③</div>		Qty.	Value ( <i>Valeur</i> )	Net Weight ( <i>Poids net</i> )
Insured No. <b>V-</b>	Insured Amount US \$	SDR Insured Value	Postage US \$	Gross Weight lb oz
⑦	⑧	⑨	⑩	⑪
Check One: <input checked="" type="checkbox"/> Commercial Sample ( <i>Echantillon commercial</i> )		<input type="checkbox"/> Documents	<input type="checkbox"/> Gift ( <i>Cadeau</i> )	<input type="checkbox"/> Merchandise
Sender's Instructions in Case of Nondelivery <i>(Instructions de l'expéditeur en cas de non-livraison)</i>  <input type="checkbox"/> Return to Sender ( <i>Renvoyer à l'origine</i> ) <b>NOTE:</b> Item subject to return charges at sender's expense.  <input type="checkbox"/> Abandon ( <i>Abandonner</i> ) <input type="checkbox"/> Redirect to Address Below ( <i>Réexpédier à</i> ):		Sender's Signature and Date ( <i>Signature de l'expéditeur et date</i> )  <div style="text-align: center;">⑥</div> I certify that the particulars given in the customs declaration are correct and that this item does not contain any dangerous article prohibited by postal regulations.  Notice to senders: Copy 4 of this customs declaration is filed at the post office for 30 days from the date of mailing.		
PS Form <b>2976-A</b> , Nov 1996 Do not duplicate form without USPS approval. 102595-97-B-0105		Copy 1 - Customs Declaration		

<b>Customs Declaration and Dispatch Note</b>				
Sender's Name and Address ( <i>Nom et adresse de l'expéditeur</i> )		Addressee's Name and Address ( <i>Nom et adresse du destinataire</i> )		
		Customs Duty <i>(Droit de douane)</i>	Customs Stamp <i>(Timbre de la douane)</i>	Mailing Office Date Stamp <i>(Timbre de bureau d'origine)</i>  <div style="text-align: center;">⑫</div>
Insured No. <b>V-</b>	Insured Amount US \$	SDR Insured Value	Postage US \$	Gross Weight lb oz
Check One: <input type="checkbox"/> Commercial Sample ( <i>Echantillon commercial</i> )		<input type="checkbox"/> Documents	<input type="checkbox"/> Gift ( <i>Cadeau</i> )	<input type="checkbox"/> Merchandise
Sender's Instructions in Case of Nondelivery <i>(Instructions de l'expéditeur en cas de non-livraison)</i>  <input type="checkbox"/> Return to Sender ( <i>Renvoyer à l'origine</i> ) <b>NOTE:</b> Item subject to return charges at sender's expense.  <input type="checkbox"/> Abandon ( <i>Abandonner</i> ) <input type="checkbox"/> Redirect to Address Below ( <i>Réexpédier à</i> ):		Sender's Signature and Date ( <i>Signature de l'expéditeur et date</i> )  I certify that the particulars given in the customs declaration are correct and that this item does not contain any dangerous article prohibited by postal regulations.  Addressee's Signature and Date ( <i>Signature du destinataire et date</i> )  I certify that this item was delivered to me ( <i>Signature of Addressee</i> ) Je certifie que cette marchandise m'a été livrée ( <i>Signature du destinataire</i> )		
PS Form <b>2976-A</b> , Nov 1996 Do not duplicate form without USPS approval. 102595-97-B-0105		Copy 3 - Dispatch Note		

PC10413

Figure 4-13—PS Form 2976-A, Customs Declaration and Dispatch Note.



Block 12: The accepting clerk stamps with an APDS the “Mailing Office Date Stamp” block of Copy 3.

NOTE: Copy 4 of PS form 2976-A is detached by the accepting clerk and maintained at the post office for 30 days.

### ATTACHING CUSTOMS DECLARATIONS

Space permitting, all customs forms must be placed on the address side of the article, preferably to the bottom left-hand side. See figure 4-14. PS Form 2976 has a self-adhesive backing. Remove the protective covering before affixing.

After the clerk dates copy 3 and detaches copy 4 of the PS Form 2976-A, the form set is returned to the customer. The customer must place the form set (copies 1, 2, and 3) into the envelope (PS Form 2976-E) and affix the envelope to the package. PS Form 2976-E is a clear plastic envelope with a peel-and-seal flap.

### BONA FIDE GIFTS

Military and civilian personnel who are authorized to use the Military Postal Service located outside the CTUS, may send duty-free, unsolicited gifts through the mail to addressees in the U.S. provided that:

- The gift does not exceed \$100 in value (\$200 when sent from Guam, American Samoa, and the Virgin Islands).

- The recipient does not receive more than one such shipment on the same day. Gifts that exceed this retail value limitation will be subject to payment of duty, on the entire value of the shipment, by the person receiving the gift. A person mailing a gift may NOT pay the duty in advance.

Gifts that are intended for several people may be sent inside one parcel, to a single addressee, provided that:

Each individual gift is wrapped and bears the name and address of the recipient, and is endorsed “UNSOLICITED GIFT.”

The outer parcel, containing the multiple gifts, is endorsed on the address side to show the number of individual gifts enclosed and value information. For example, a parcel containing 3 individual gift parcels, for separate individuals, would be endorsed “THREE UNSOLICITED GIFTS ENCLOSED. NO ONE INDIVIDUAL RECEIVING GIFTS EXCEEDING \$100 IN VALUE” or similar wording.

### AMERICAN GOODS RETURNED

Articles that are grown, produced, or manufactured in the U.S. and which, after having been exported, have not increased in value or improved in condition, may be mailed back to the U.S. free from customs duty. However, a properly completed customs declaration shall be attached to the address side of the

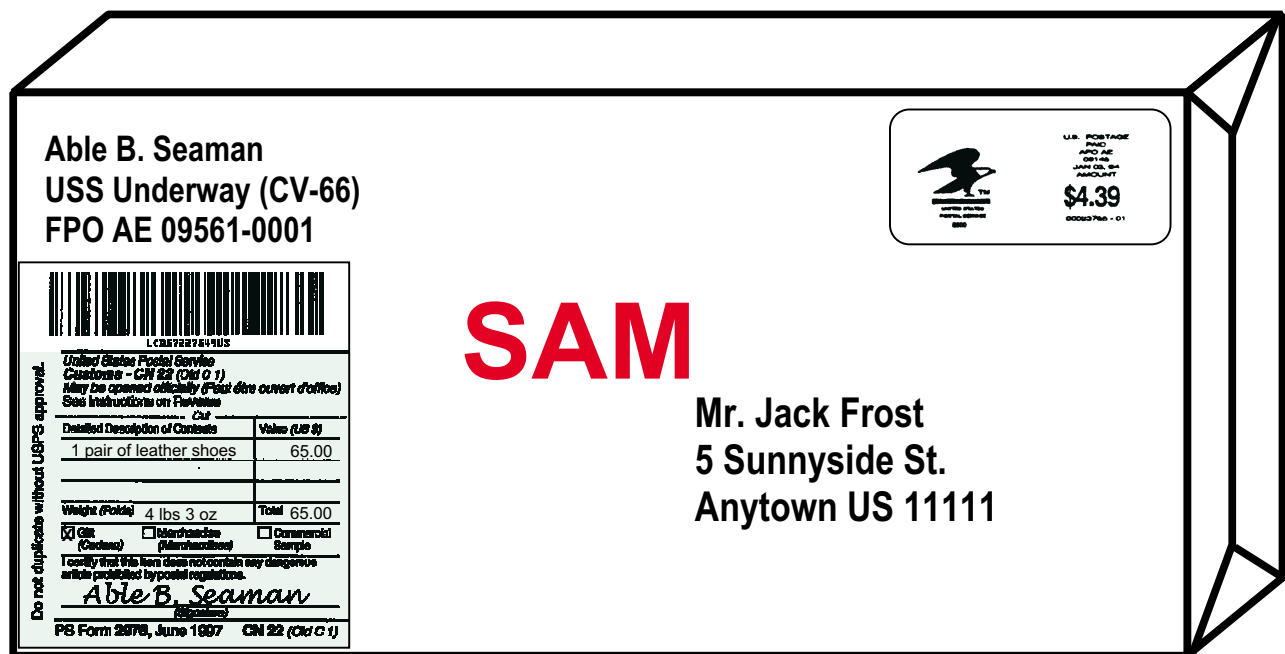

PCF0414

Figure 4-14—Parcel depicting placement of customs form.

parcel with the words “AMERICAN GOODS RETURNED” endorsed on the customs declaration.

### **PERSONAL PROPERTY AND HOUSEHOLD EFFECTS**

Personal and household effects of personnel stationed outside the CTUS, returning to the United States under government orders may be exempt from customs duty. In this case, customers must place a copy of their orders inside the envelope (PS Form 2976-E) or inside the parcel. The address side of the parcel shall be endorsed “RETURNED PERSONAL EFFECTS—ORDERS ENCLOSED.” Parcels containing personal and household effects shall bear a completed customs form.

### **ITEMS BEARING A TRADEMARK OR TRADE NAME**

Some articles such as perfumes, watches, and cameras bearing a trademark or trade name require written consent of the owner of the mark or name before they can be imported. If an article of this type is presented for mailing, advise the customer that the article may not pass U.S. Customs. However, DO NOT refuse to accept the article if it meets all other mailing requirements. Remember that it is the mailer who is responsible for complying with the customs laws.

- Q4-24. What items are subject to customs examination?*
- Q4-25. When a parcel containing merchandise is mailed from an overseas MPO to an address in CONUS, it is not subject to customs examination. (True/False) Explain.*
- Q4-26. Who is responsible for complying with customs laws?*
- Q4-27. Who is responsible for completing the Detailed Description of Contents section of a customs declaration?*
- Q4-28. What responsibility does the military postal clerk have in compliance of customs laws in conjunction with the mailer’s desires?*
- Q4-29. What PS form and form envelope should be used on parcels mailed from any overseas MPO to a CONUS address?*
- Q4-30. What customs declaration is placed inside a parcel at the mailer’s request to avoid*

*identifying the contents on the outside of the parcel?*

- Q4-31. Why is customs duty sometimes improperly assessed on articles entering the United States?*
- Q4-32. Proper completion of customs declaration forms will ensure that parcels will pass through U.S. Customs with a minimum delay. (True/False)*
- Q4-33. What is the maximum dollar amount that an individual may mail to an individual in the United States to qualify as an unsolicited, free from duty gift?*

Now turn to appendix 1 to check your answers.

### **CHECKLIST FOR ACCEPTANCE OF DOMESTIC MAIL**

The following information is provided for assisting you in understanding the acceptance of domestic mail.

#### **TYPES OF MATTER**

**FIRST-CLASS:** Hand or type written material, matter protected against unauthorized inspection, personal messages (e.g. letters, bills, statements, and invitations).

**PERIODICALS:** Complete newspapers and magazines.

**STANDARD MAIL (A):** Rates are presorted. Not used by MPS.

**STANDARD MAIL (B):** Items not included in First-Class or Periodicals, weighing 16 ounces to 70 pounds.

#### **RATES OF POSTAGE**

Express Mail

First-Class Mail

Priority Mail

Standard Mail (A)

Standard Mail (B)

Special Standard Mail

Library Mail

## CHECKLIST FOR ACCEPTANCE OF DOMESTIC MAIL

SENDERS REQUEST	TYPE OF MATTER	WEIGHT	RATE OF POSTAGE	ENDORSEMANT
EXPRESS MAIL	REGARDLESS OF TYPE	UP TO 70 LBS	EXPRESS MAIL	MILITARY SERVICE
PRIORITY, FIRST-CLASS OR FASTEST WAY	REGARDLESS OF TYPE	→ 11 OZS OR LESS → OVER 11 OZ TO 70 LBS	→ FIRST CLASS → PRIORITY	→ FIRST-CLASS → USPS LABEL 17
CHEAPEST WAY	FIRST-CLASS	→ 11 OZS OR LESS → OVER 11 OZ TO 70 LBS	→ FIRST CLASS → PRIORITY	→ FIRST-CLASS → USPS LABEL 17
CHEAPEST WAY	PERIODICALS	→ 11 OZS OR LESS → OVER 11 OZ TO 15.99 OZ → 16 OZS TO 70 LBS	→ FIRST CLASS → STANDARD MAIL (A)*1 → STANDARD MAIL (B)	→ FIRST-CLASS → STANDARD MAIL-SAM → SAM
CHEAPEST WAY	STANDARD MAIL (A)	→ 11 OZS OR LESS → OVER 11 OZ TO 15.99 OZ	→ FIRST CLASS → STANDARD MAIL (A)*1	→ FIRST-CLASS → STANDARD MAIL-SAM
CHEAPEST WAY	STANDARD MAIL (B)	16 OZ TO 70 LBS	STANDARD MAIL (B)	SAM
CHEAPEST WAY	STANDARD MAIL (B) (BOOKS, FILMS, AND SOUND RECORDINGS)	16 OZ TO 70 LBS	SPECIAL STANDARD MAIL (COMPARED WITH STANDARD MAIL [B])	SPECIAL STANDARD MAIL-SAM
CHEAPEST WAY	STANDARD MAIL (B) (IF QUALIFIES FOR LIBRARY RATE)	16 OZ TO 70 LBS	LIBRARY (COMPARED WITH STANDARD MAIL [B])	LIBRARY-SAM
PAL*2	PERIODICALS, STANDARD MAIL (A), OR STANDARD MAIL (B) MATTER	1 OZ TO 30 LBS	STANDARD MAIL (A) OR STANDARD MAIL (B)	PAL

ALL STANDARD MAIL (B) MUST BE COMPARED TO PRIORITY FOR THE CHEAPEST RATE.  
 PARCEL POST ALSO MEANS CHEAPEST WAY.

PC10404

\*1 IN SOME INSTANCES STANDARD MAIL (B) RATES IS CHEAPER THAN STANDARD MAIL (A). ALWAYS COMPARE RATES!

\*2 FIRST CLASS OR PRIORITY MAIL MAY BE CHEAPER THAN PAL.

**Table 4-4—Checklist for Acceptance of Domestic Mail.**



## CHAPTER 5

# SPECIAL SERVICES

Special services provide for the handling of mail in other than the routine and ordinary manner. Special services require fees in addition to the regular postage. In this chapter you will learn about the special services available to customers for domestic mail presented for mailing at MPOs. You will also learn what specific special services are available for the various classes of mail and how to compute the fees for such services. Special services for international mail will be discussed in chapter 6.

### REGISTERED MAIL

Registered mail service is designed to give added protection for valuable and important mail. Postal insurance coverage may be purchased for mail that is registered in the event of loss or damage. Registered mail is the most secure service the USPS offers. It incorporates a system of receipts to monitor the mail's movement from the point of acceptance to delivery. The sender is provided a mailing receipt, the accepting post office maintains a copy of the receipt, and a delivery record is kept at the post office of address. For a complete discussion on registered mail, refer to chapter 7.

### OTHER SPECIAL SERVICES

---

**Learning Objective:** *Recognize other special services available at an MPO.*

---

Registered mail is one of the USPS special services offered by MPOs. In this section you will learn about the other special services that are available. These special services include the following:

- Certified mail
- Insured mail (unnumbered and numbered)
- Special handling
- Certificate of mailing
- Return receipt

- Return receipt after mailing/duplicate return receipt
- Return receipt for merchandise
- Restricted delivery

### CERTIFIED MAIL

Certified mail provides the postal customer with a mailing receipt at the time of mailing and a record of delivery is kept at the post office of address. There is no record kept at the accepting post office. Only mailable matter on which postage at the First-Class or priority mail rate has been paid will be accepted as certified mail. Patrons should be advised that certified mail does not provide postal insurance, thus if the article is lost or damaged, no monetary loss can be claimed. Certified mail may be addressed for delivery only to the U.S. and its territories and possessions, through APO/FPO post offices, or through the United Nations Post Office, New York. **DO NOT** accept certified articles destined to international addresses.

Certified mail receipts are completed in the original only. The receipt is designed so that the sender can easily complete it. When the customer presents an article for mailing as certified mail, you, as the accepting clerk, must postmark the receipt with an APDS. If the proper postage and fees have been paid on a certified article, it can be deposited in any mailbox. However, if the sender desires to have the receipt postmarked the article must be taken to the post office.

Certified mail service can be combined with other special services. Some of these other special services include return receipts, and restricted delivery. (Return receipts and restricted delivery will be discussed in detail later in this chapter.)

### Fees

The fee for certified mail is collected in addition to the appropriate First-Class or priority mail postage and any additional fee(s) for other special services. The fee for certified mail can be found in Module R of the DMM.

## Completing the Mailing Receipt

Accepting clerks must prepare a Certified Mail Receipt (PS Form 3800), when mail to be certified is presented at the post office (see figure 5-1). Complete this form as follows:

- Block 1: Enter name of addressee (individual or firm).
- Block 2: Enter postage to be collected (First Class/Priority).
- Block 3: Enter certified fee.
- Block 4: Enter fee(s) for additional services requested.
- Block 5: Enter the total of postage and fee(s) to be collected.
- Block 6: Enter name of addressee (individual or firm).
- Block 7: Enter street address and number.
- Block 8: Enter city, state, and ZIP Code, or APO/FPO number.
- Block 9: Apply postmark with the APDS.

## Certified Mail Endorsement

After completing the form, detach the certified mail stub from the left side of the PS Form 3800. Peel the protective tape from the back of the stub and place the stub on the address side of the article above the address and to the right of the return address, leaving room to affix postage stamps. For envelopes, note that

a portion of the top of the stub can be folded over the top of the envelope (see figure 5-2).

## INSURED MAIL

Postal insurance is a service that customers may purchase to reimburse them for loss or damage that may occur to an article after it has been mailed. To receive postal insurance, the customer must request this service and pay the applicable insurance fee in addition to the appropriate rate of postage. The USPS will reimburse the customer if loss or damage occurs while the article is in its custody. The amount the customer is reimbursed is based on one or more of the following factors:

- The amount of insurance requested (based on the fee and not to exceed the value of the article)
- Cost or value of the article
- Cost of any repairs
- Replacement cost of the article

## What Can Be Insured

The following types of mail may be insured:

- Standard Mail (B)
- Standard Mail matter mailed at the First-Class Mail or Priority Mail rate of postage

Figure 5-1.—An example of a Certified Mail Receipt (PS Form 3800).

PCf0501

**U.S. Postal Service**  
**CERTIFIED MAIL RECEIPT**  
*(Domestic Mail Only; No Insurance Coverage Provided)*

Article Sent To: \_\_\_\_\_

Postage	\$	Postmark Here
Certified Fee		
Return Receipt Fee (Endorsement Required)		
Restricted Delivery Fee (Endorsement Required)		
<b>Total Postage &amp; Fees</b>	\$	

Name (Please Print Clearly) (to be completed by mailer)  
 \_\_\_\_\_  
 Street, Apt. No., or PO Box No.  
 \_\_\_\_\_  
 City, State, ZIP+4  
 \_\_\_\_\_

PS Form 3800, July 1999 See Reverse for instructions

7000 0600 0023 4109 6776



PCf0502

**Figure 5-2.—An example of proper placement of a Certified Mail endorsement.**

**What Cannot Be Insured**

The following types of mail cannot be insured:

- Parcels containing matter offered for sale addressed to prospective purchasers who have not ordered or authorized their sending. If such matter is mailed, payment is not made for loss, rifling, or damage.
- Nonmailable matter.
- Articles so fragile that they cannot be carried safely in the mail regardless of packaging.

- Articles not adequately prepared to withstand normal handling in the mail. As a rule, any mailable package should be insurable.
- Mail not bearing the complete names and addresses of the sender and addressee.

**Mailing Procedures**

If the mailer wants to insure an article, it must be mailed at the post office. Articles to be insured must not be placed in mail drops at post offices or in street mail collection boxes.

As the accepting clerk at the window, you are required to ask whether or not the package contains fragile, perishable, or liquid matter. If the package contains any matter of this type, further inquiry should be made to determine whether the contents are mailable and properly packed.

Mailers are issued a receipt for each insured parcel mailed. The type of receipt that is issued depends on the amount for which the parcel is insured.

### UNNUMBERED INSURED MAIL

For monetary value amounts for unnumbered insured articles, refer to Module R of the DMM.

#### Fee

The fee for unnumbered insured mail is collected in addition to the appropriate rate of postage and any additional fee(s) for other services. The fee for unnumbered insured mail can be found in Module R of the DMM.

#### Completing the Mailing Receipt

After determining that the parcel is mailable, complete Receipt for Domestic Insured Parcel (PS Form 3813) (see figure 5-3). PS Form 3813 is an original-only receipt and is retained by the mailer. No other copies or record is kept at the office of mailing or by the office of delivery.

The following instructions explain how to complete PS Form 3813:

Block 1: Enter the city, state, and ZIP Code or unit designation and APO/FPO number of the addressee on the article.

Block 2: Enter the amount of postage charged for the article. When Parcel Airlift (PAL) service is provided, add the postage and PAL fee together and place the total in the postage block.

Block 3: Enter the unnumbered insurance fee.

Block 4: Enter fee(s) for additional services requested.

Block 5: Enter the total amount of the postage and fees.

Block 6: Enter the amount of insurance coverage. This amount should be the actual value of the content(s).

Block 7: Ask the mailer whether the package presented for insurance contains fragile, perishable, or liquid matter. If so, mark the appropriate box.

PCF0503

Figure 5-3.—An example of a Receipt for Domestic Insured Parcel (PS Form 3813) (front and reverse).

Block 8: Accepting clerk initials.

Block 9: Postmark with the APDS.

Block 10: The customer completes information on the reverse side.

#### Unnumbered Insured Mail Endorsement

The endorsement for unnumbered insured mail is a rubber elliptical stamp. This endorsement should be placed top center, on the address side of the article (see figure 5-4).



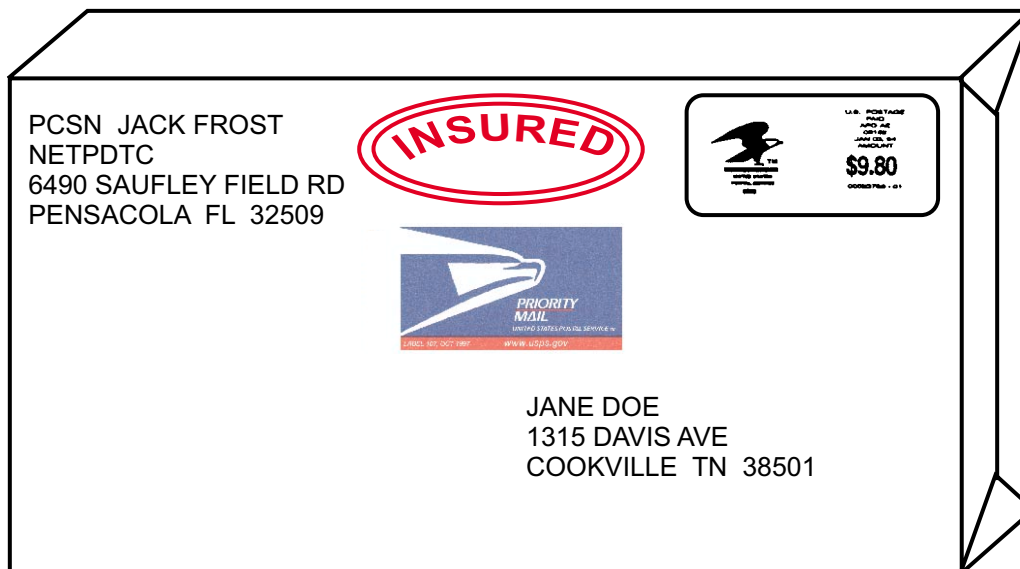

PCF0504

Figure 5-4.—An example of an Unnumbered Insured Elliptical Stamp.

## NUMBERED INSURED MAIL

For monetary value amounts for numbered insured articles, refer to Module R of the DMM. Unlike unnumbered insured, a record of delivery is maintained at the delivery post office for numbered insured mail. The addressee must sign for numbered insured articles when the articles are delivered and a record of delivery is kept by the post office of delivery.

### Fee

The fee for numbered insured mail is based upon the liability coverage requested. Liability amounts can be found in Module R of the DMM. The appropriate fee for a numbered insured article is collected from the customer in addition to the applicable postage and any other fees. Refer to Module R of the DMM for insurance fees.

### Completing the Mailing Receipt

After determining that the article isailable, complete Insured Mail Receipt (PS Form 3813-P) (see figure 5-5). The PS Form 3813-P is completed in a similar manner as the PS Form 3813. It is an original-only form that is retained by the mailer. No copy or record is kept at the post office of mailing. Other special services such as PAL, restricted delivery and return receipts can be combined with numbered insured service.

The following instructions explain how to complete PS Form 3813-P:

Block 1: Enter amount of postage to be collected (include surcharge, discount or PAL fee).

Block 2: Ask the mailer whether the package presented for insurance contains fragile, liquid or perishable matter. If so, then mark the appropriate box.

Block 3: Enter insurance fee based on the amount of insurance coverage.

Block 4: Enter the amount of insurance coverage. This amount must be the actual value of the content(s).

Block 5: Enter fee(s) for additional services requested.

Block 6: Enter the total of postage and fee(s) to be collected.

Block 7: Enter name of addressee (individual or firm).

Block 8: Enter street address and number.

Block 9: Enter city, state and ZIP Code, or APO/FPO number.

Block 10: Postmark with APDS.

### Numbered Insured Endorsement

After completing the form, detach the numbered insured mail stub from the left side of the PS Form 3813-P. Peel the protective tape from the back of the stub and place the stub on the address side of the article above the address and to the right of the return address, leaving room to affix postage stamps (see figure 5-6).

### SPECIAL HANDLING

Special handling service provides preferential handling to the extent practicable in dispatch and

Figure 5-5.—An example of an Insured Mail Receipt PS Form 3813-P.

transportation. Special handling service is available ONLY for First-Class Mail, Priority Mail, and Standard Mail (B) (Parcel Post, Bound Printed Matter, Special Standard Mail, and Library Mail). It can be combined with insured articles and return receipt for merchandise.

DO NOT charge a surcharge when standard mail articles are mailed special handling, but if they qualify for a discount, give a discount.

### Fee

The applicable special handling fee must be paid in addition to the appropriate rate of postage for each article for which special handling service is requested. Refer to Module R of the DMM for the correct fee.

### Endorsement

The endorsement “SPECIAL HANDLING” must appear, prominently, above the address and to the right of the return address on each piece for which special handling service is requested. See figure 5-7.

## CERTIFICATES OF MAILING

At times postal customers may want a receipt as evidence of mailing an article, but they do not want to register, certify, or insure the article. The mailer may be provided a receipt for ordinary mail by purchasing a Certificate of Mailing (PS Form 3817). Advise the mailer that certificates of mailing furnish evidence of

mailing only. Certificates of mailing do not insure the article against loss or damage. A signature is not obtained from the addressee for the article. This service is available for all classes of mail.

Certificates of mailing are prepared by the mailer. The finance clerk collects the fee and gives the mailer an equal amount of stamps. The customer should affix the stamps in the upper right-hand corner of the certificate. The finance clerk compares the information on the form with that on the article and cancels the stamp(s) with a flagstamp cancellation device.

### Fee

The fee paid for a Certificate of Mailing is in addition to the postage required to mail the article(s). The fee for a Certificate of Mailing can be found in Module R of the DMM.

### Completing the Required Form

PS Form 3817 (see figure 5-8), is used for each piece of ordinary mail of any class. As stated earlier, the mailer completes the form before presenting the article to a clerk for mailing. Once the correct postage and fee is collected, the postage is affixed on the article, and the stamp(s) or meter tape used for the fee is affixed to the space provided on the PS Form 3817.

U.S. Postal Service  
INSURED MAIL RECEIPT

NOTE: To file a claim for damage or loss of contents, the article, contents, and packing must be presented.

VV 855 491 589 US

Postage	\$	<input type="checkbox"/> Fragile <input type="checkbox"/> Liquid
Insurance Fee		<input type="checkbox"/> Perishable
Restricted Delivery Fee (Domestic only; endorsement required)		Insurance Coverage
Special Handling Fee		Postmark Here
Return Receipt Fee (Except for Canada; endorsement required)		
Total Postage & Fees	\$	

Recipients Name (Please Print Clearly - To be completed by mailer)

Street, Apt. No., or PO Box No.

City, State, ZIP+4, Country

PS Form 3813-R, Feb. 2000 See Reverse for Instructions

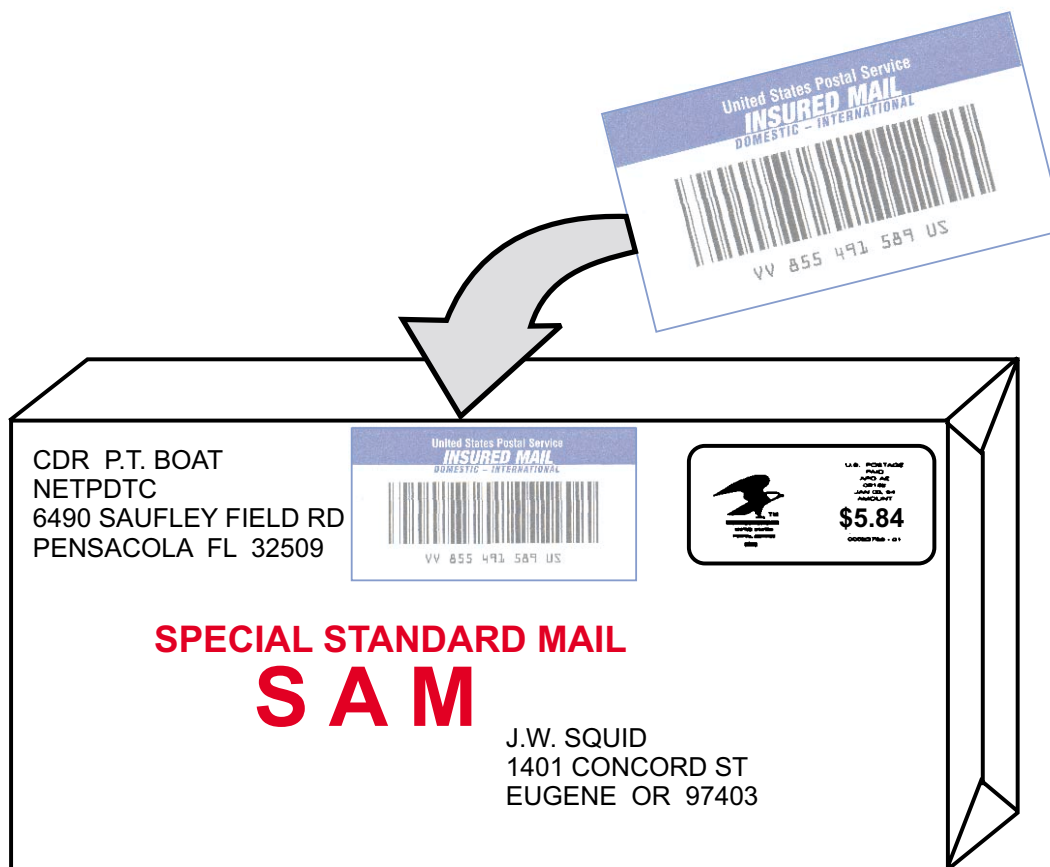

PCF0506

Figure 5-6.—An example of proper placement of a Numbered Insured endorsement.

Then if postage stamps are used, they are canceled by the accepting clerk as shown in figure 5-8.

This form is completed as follows:

Step 1: The mailer enters the complete return address just as it appears on the article presented for mailing.

Step 2: The mailer enters the complete address of addressee just as it appears on the article.

Step 3: The mailer affixes a postage stamp(s) for the fee in this area, or the accepting clerk affixes a postage meter strip.

Step 4: The accepting clerk cancels the postage stamp(s).

### Endorsement

There is no endorsement made to the article presented for mailing to indicate that a Certificate of Mailing was purchased.

### RETURN RECEIPT

Some customers may want to know when a particular piece of mail has been delivered to an

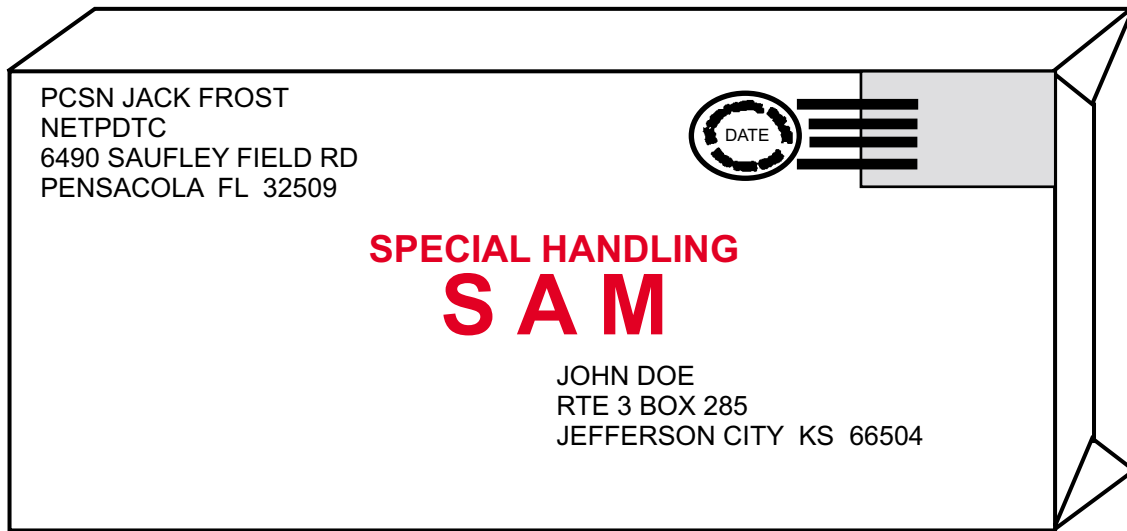

PCf0507

Figure 5-7.—An example of proper placement of a Special Handling endorsement.

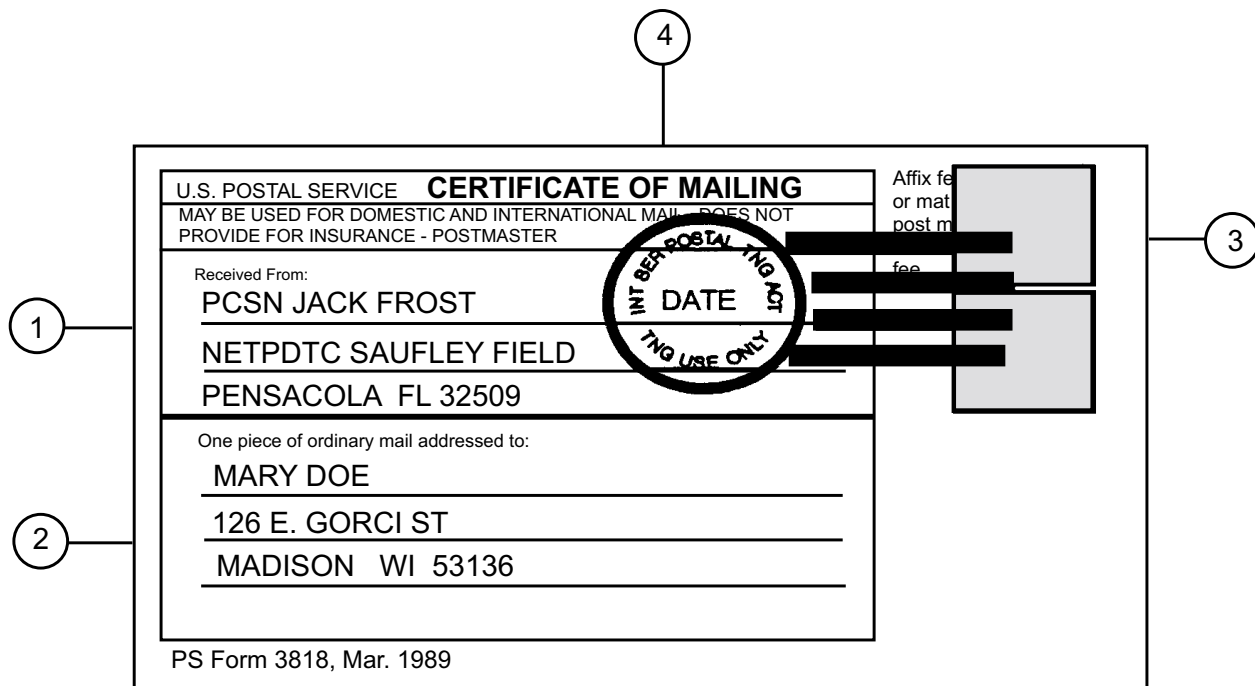

PCf0508

Figure 5-8.—An example of a completed Certificate of Mailing.

addressee. Return receipt service provides the mailer with evidence of delivery, by requiring the addressee or the addressee's agent sign the receipt then return it to the mailer. No copy or record is maintained at the office of mailing. The service may only be obtained for articles sent registered, numbered insured (insured for more than \$50.00), certified, and as Express Mail.

#### Fee

The mailer must pay the applicable fee for return receipt service in addition to postage and any other

fee(s). Return receipt service can provide varying degrees of delivery information about the article. Based upon the customer's desires, a return receipt can be requested that will provide the signature of the addressee, or agent, and the date the article was delivered. It can show to whom (signature), date, and the addressee's address where delivered. A return receipt can also be requested for an article after the date of mailing. The varying degrees of information provided and date requested affect the amount of the

fee that will be collected. Refer to Module R of the DMM to find the correct fee.

### Completing the Required Form

PS Form 3811, Domestic Return Receipt, is used for return receipt service (see figure 5-9). It is a green two-sided form that is normally affixed to the address side of larger parcels and to the back of envelopes or small parcels. This must be done without covering other markings or endorsements.

Complete this form as follows:

Block 1: Check this box **ONLY** when “Return Receipt Requested Showing Address Where Delivered” service is requested.

Block 2: Check this box if “Restricted Delivery” service is requested in addition to the return receipt.

Block 3: Enter the complete name and address of the addressee, just as it appears on the article presented for mailing.

Is your RETURN ADDRESS completed on the reverse side?	<b>SENDER:</b> ■ Complete items 1 and/or 2 for additional services. ■ Complete items 3, 4a, and 4b. ■ Print your name and address on the reverse of this form so that we can return this card to you. ■ Attach this form to the front of the mailpiece, or on the back if space does not permit. ■ Write "Return Receipt Requested" on the mailpiece below the article number. ■ The Return Receipt will show to whom the article was delivered and the date delivered.		I also wish to receive the following services (for an extra fee): 1. <input type="checkbox"/> Addressee's Address 2. <input type="checkbox"/> Restricted Delivery Consult postmaster for fee.	
	3. Article Addressed to: ←  FLORENCE FLEGLEMEYER 123 46TH ST INDIANAPOLIS IN 46205		4a. Article Number VV 855 491 589 US 4b. Service Type <input type="checkbox"/> Registered <input type="checkbox"/> Certified <input type="checkbox"/> Express Mail <input checked="" type="checkbox"/> Insured <input type="checkbox"/> Return Receipt for Merchandise <input type="checkbox"/> COD 7. Date of Delivery	
5. Received By: (Print Name)		8. Addressee's Address (Only if requested and fee is paid)		Thank you for using Return Receipt Service.
6. Signature: (Addressee or Agent) X				
PS Form 3811, December 1994			Domestic Return Receipt	

### FRONT

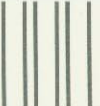
UNITED STATES POSTAL SERVICE		First-Class Mail Postage & Fees Paid USPS Permit No. G-10
● Print your name, address, and ZIP Code in this box ●		
→ PCSN JACK FROST NETPDTC 6490 SAUFLEY FIELD RD PENSACOLA FL 32509		

### REVERSE

Figure 5-9.—An example of a completed Domestic Return Receipt (PS Form 3811) (front/reverse).

PCf0509

Block 4a: Enter the article number. (Example: RR 123 456 789 US, VV 855 491 592 US, 7000 0600 0023 4109 6776, or EH716870065US.)

Block 4b: Check one block for the type of service being used.

Block 5: Leave items 5 through 8 blank.

NOTE: Items numbered 5 through 8 are completed when the article is delivered to the addressee or authorized agent.

On the reverse side, legibly, enter mailer's full name, street address, city, state and ZIP Code, or APO/FPO number.

### Endorsement

Mail for which return receipt service is requested must be endorsed "Return Receipt Requested" or "Return Receipt Requested Showing Address Where Delivered" based on the fee paid. The endorsement must be placed above the delivery address and to the right of the return address, taking care not to over-strike or obliterate any other endorsements or portions of the address (see figure 5-10).

### Request for Delivery Information/Return Receipt After Mailing

After an accountable article has been mailed, a return receipt may still be obtained. To do so, the mailer must do the following:

- Complete Section 2 of PS Form 3811-A, Request for Delivery Information/Return Receipt After Mailing.

- Attach the proper amount of postage for the fee to the PS Form 3811-A if not paid previously and postmark using APDS.

- Mail the entire PS Form 3811-A to the post office of delivery.

The post office of delivery will provide the mailer with the date of delivery and the name of the person who signed for the article. Neither the signature of the person who signed for the article nor the address of delivery will be provided.

### Duplicate Return Receipt

In the event the mailer has not received a return receipt, a duplicate may be requested under the following conditions:

- A reasonable period of time has passed since the article was mailed.
- It has been within 1 year since the article was mailed.
- The mailer has a receipt showing that a fee was paid for this service. (Certified mail receipt must have been postmarked at a post office.)

When a duplicate return receipt is requested, you should assist the mailer in completing a PS Form 3811-A. There is no charge for obtaining a duplicate return receipt.

A request for a duplicate return receipt or a copy of the delivery record for Express Mail must be filed within 90 days after the date of mailing.



PCf0510

Figure 5-10.—An example of proper placement of a Return Receipt endorsement.

## RETURN RECEIPT FOR MERCHANDISE

Return receipt for merchandise is a form of return receipt service that provides the sender with a mailing receipt (PS Form 3804) and a return receipt (PS Form 3811). A delivery record is kept at the post office of address, but no record is kept at the office of mailing. A return receipt for merchandise also provides the recipient's actual delivery address if it is different from the address used by the sender. Mail with this service is dispatched and handled in transit as ordinary mail. This service does not include insurance coverage and a return receipt for merchandise cannot be requested after mailing. Restricted delivery service is not available.

This service is available for merchandise sent at the Priority Mail or Standard Mail (B) rates. This service cannot be used on international mail.

### Fee

The applicable fee for return receipt for merchandise service must be paid in addition to the correct postage and the fees for any other service requested. Refer to Module R of the DMM to find the correct fee.

### Completing the Required Form

PS Form 3804, Return Receipt for Merchandise (see figure 5-11), is used for return receipt service along with PS Form 3811 (see figure 5-9).

Complete PS Form 3804 as follows:

- Block 1: Enter postage to be collected.
- Block 2: Enter return receipt for merchandise fee.
- Block 3: Enter fee for additional service requested.
- Block 4: Enter the total amount of postage and fees to be collected.
- Block 5: The mailer must check waiver of signature yes or no block.
- Block 6: Enter name of addressee (individual or firm).
- Block 7: Enter street address and number.
- Block 8: Enter city, state, and ZIP Code, or APO/FPO number.
- Block 9: Apply postmark with APDS.

When the form is completed, prepare PS Form 3811 (figure 5-9) and place the number on the stub from PS Form 3804 in block 4a and check return receipt for merchandise in block 4b.

### Endorsement

After completing the forms, detach the return receipt for merchandise stub from the left side of the PS Form 3804. Peel the protective tape from the back of the stub and place the stub on the address side of the article above the address and to the right of the return address, leaving room to affix postage stamps (see

**RETURN RECEIPT FOR MERCHANDISE**

8000 0940 0002 5435 1892

**WAIVER OF SIGNATURE**  
I wish delivery to be made without obtaining signature of the addressee or the addressee's agent. I authorize the delivery employee to sign that the shipment was delivered and understand that the signature of the delivery employee will constitute valid proof of delivery.

**CUSTOMER SIGNATURE**

8000 0940 0002 5435 1892

**U.S. Postal Service**  
**RETURN RECEIPT FOR MERCHANDISE**  
(Domestic Mail Only; No Insurance Coverage Provided)

Postage \$	①	Postmark Here ⑨
Return Receipt for Merchandise Fee (Endorsement Required)	②	
Special Handling Fee	③	
Total Postage & Fees \$	④	

Waiver of Signature  YES  NO — ⑤

Recipient's Name (Please Print Clearly) (to be completed by mailer) ⑥

Street, Apt. No., or PO Box No. ⑦

City, State, ZIP+4 ⑧

PS Form 3804, February 2000 See Reverse for Instructions

Figure 5-11.—An example of a Return Receipt for Merchandise (PS Form 3804).

PCf0511

figure 5-12). Attach PS Form 3811 on the front (if space allows) or the reverse side of the article.

**RESTRICTED DELIVERY SERVICE**

Restricted delivery service permits a mailer to direct delivery of an article only to the addressee or a person, authorized in writing, as the addressee’s agent. The addressee must be an individual (person) specified by name. Restricted delivery mail CANNOT be addressed to a company, corporation, or firm. Only the addressee, or authorized agent, may sign for the article.

Restricted delivery may be obtained only for registered mail, certified mail, and numbered insured mail. Restricted delivery service DOES NOT require completion of a form.

**Fee**

The applicable fee for restricted delivery service must be paid in addition to the postage and any other fee(s). Refer to Module R of the DMM to find the correct fee.



PCSN JACK FROST  
NETPDC  
6490 SAUFLEY FIELD RD  
PENSACOLA FL 32509

**RETURN RECEIPT  
FOR MERCHANDISE**

8000 0940 0002 5435 1892

**\$4.42**

00000710 - 01

**PRIORITY MAIL**  
WITH REGISTERED MAIL SERVICE

MS FRANNIE FLAGGLEMAYER  
18 MADISON AVE  
PHILADELPHIA PA 19153

PCf0512

Figure 5-12.—An example of proper placement of a Return Receipt for Merchandise endorsement.



## Endorsement

Mail for which restricted delivery service is requested, must be endorsed "RESTRICTED DELIVERY." The endorsement must be placed above the delivery address and to the right of the return address. See figure 5-13.

- Q5-1. What service does certified mail provide?
- Q5-2. At what class of mail must postage be paid before an article can be sent as certified mail?
- Q5-3. What is the maximum amount of insurance, if any, that can be purchased for certified mail?
- Q5-4. PS Form 3800 should be prepared when certified mail service is provided? (True/False)
- Q5-5. What benefit of service does postal insurance provide?
- Q5-6. As a general rule, any parcel that is mailable should be insurable. (True/False)
- Q5-7. What publication should you refer to find the maximum amount of indemnity for which an article in the domestic postal system can be insured?

- Q5-8. What PS form is issued to the customer for unnumbered insured mail?
- Q5-9. What PS form is issued to the customer for numbered insured mail?
- Q5-10. A postal patron desires proof of mailing of an article in the mails but does not want the article to be sent registered, insured, or certified. With what service should this patron be provided?
- Q5-11. Return receipt for merchandise can be used with what classes of mail?
- Q5-12. Where is the endorsement RESTRICTED DELIVERY placed on an article to be mailed?

Now turn to appendix 1 to check your answers.

## CHECKLIST FOR SPECIAL SERVICES

The following information is provided for assisting you in understanding the procedures for handling domestic special services. See table 5-1 (next page).



PCf0513

Figure 5-13.—An example of proper placement of a Restricted Delivery endorsement.

**Table 5-1.—Checklist for Special Services.**

<b>TYPE</b>	<b>AVAILABLE FOR</b>	<b>ENDORSEMENTS</b>	<b>FORMS</b>	<b>APDS</b>
REGISTERED MAIL	FIRST-CLASS AND PRIORITY	LABEL 200	PS FORM 3806	ALL INTERSECTING SEAMS AND PS FORM 3806
CERTIFIED MAIL	FIRST-CLASS AND PRIORITY	STUB FROM PS FORM 3800	PS FORM 3800	ON PS FORM 3800
UNNUMBERED INSURED	ARTICLES VALUED \$50.00 OR LESS	ELLIPTICAL INSURED STAMP	PS FORM 3813	ON PS FORM 3813
NUMBERED INSURED	ARTICLES VALUED \$50.01 TO \$5,000.00	STUB FROM PS FORM 3813-P	PS FORM 3813-P	ON PS FORM 3813-P
SPECIAL HANDLING	FIRST-CLASS, PRIORITY, AND STANDARD MAIL (B)	SPECIAL HANDLING STAMP	NONE	NONE
CERTIFICATE OF MAILING	ANY CLASS OF MAIL	NONE	PS FORM 3817	NONE
RETURN RECEIPT	REGISTERED, EXPRESS, CERTIFIED, AND NUMBERED INSURED MAIL	RETURN RECEIPT REQUESTED OR RETURN RECEIPT REQUESTED SHOWING ADDRESSEE'S ADDRESS OR RETURN RECEIPT REQUESTED SHOWING ADDRESS WHERE DELIVERED	PS FORM 3811	IF REGISTERED, HALF ON THE PS FORM 3811 AND HALF ON THE ARTICLE
RETURN RECEIPT FOR MERCHANDISE	PRIORITY AND STANDARD MAIL (B) MAIL	STUB FROM PS FORM 3804	PS FORM 3804 AND PS FORM 3811	ON PS FORM 3804
RESTRICTED DELIVERY	REGISTERED, CERTIFIED, AND NUMBERED INSURED MAIL ADDRESSES TO AN INDIVIDUAL BY NAME	RESTRICTED DELIVERY	NONE	NONE

## CHAPTER 6

# INTERNATIONAL MAIL

In chapter 4 you learned how to identify the classes of domestic mail, and what geographical areas are within the U.S. domestic postal system. But, what about mail that is addressed to foreign countries? First, mail addressed to a foreign country is called international mail and differs from domestic mail in many ways. For example, the five classes of domestic mail (Express Mail, First-Class, Periodicals, Standard Mail (A), and Standard Mail (B)) do not apply for international mail. Also, the types of matter that may be mailed and the conditions for acceptance vary for different countries. Therefore, you must refer to the *International Mail Manual* (IMM) each time you accept an article (except for ordinary letter mail) addressed to a foreign country. The IMM contains the rates and specific conditions of mailing for each individual foreign country.

Mail addressed to overseas APO and FPO addresses or U.S. territories such as Guam, Puerto Rico, American Samoa, or the U.S. Virgin Islands is considered domestic mail, and international rates of postage must NOT be charged.

### INTERNATIONAL MAIL MANUAL

---

**Learning Objective:** *Identify the sections of the International Mail Manual.*

---

To properly accept articles addressed to foreign countries, you must know how to use the IMM. The IMM contains the regulations that apply to international mail service. It details the mailing conditions, acceptance procedures, and preparation requirements for mail sent from the United States to other countries. The IMM cross-references the DMM whenever domestic mail conditions and procedures apply. On the job you will have a DMM and an IMM to refer to.

### MAKEUP OF THE INTERNATIONAL MAIL MANUAL

The IMM consists of the following sections:

Chapter 1—International Mail Services

Chapter 2—Conditions for Mailing

Chapter 3—Special Services

Chapter 4—Treatment of Outbound Mail

Chapter 5—Nonpostal Export Regulations

Chapter 6—Special Programs

Chapter 7—Treatment of Inbound Mail

Chapter 8—(Reserved for future information)

Chapter 9—Inquiries, Indemnities, and Refunds

World Map

World Map Index

Index of Countries and Localities

Individual Country Listings

Index

Forms Index

Of the nine chapters you will primarily be concerned with chapters 1, 2, and 3. These chapters contain information on outgoing postal union mail and international parcel post. Included is information concerning mail prohibitions, restrictions, preparation requirements, customs declarations, air service, and aerogrammes. Also, special mail services such as registry, insurance, return receipts, restricted delivery, and special handling are explained.

### LOCATING INFORMATION

To properly use the IMM, you must know how to locate the desired information. The information in the IMM is listed by a decimal-type numbering system. It is set up so it is easy to find the information you need. Suppose you wanted to find information on the required use of customs forms. Go to the index in the back of the manual. Look for customs forms. There you will find that information on customs forms is located in section 123. Look through section 123 and you will find Required Usage is located in 123.61. Section 123.61 breakdown is as follows:

Chapter 1—International Mail Services

Subchapter 120—Preparation for Mailing

Part 123—Customs Forms

Section 123.6—Required Usage

Subsection 123.61—Conditions

## INDIVIDUAL COUNTRY LISTINGS

The Individual Country Listings cover all mailing information for most countries. Countries are listed in alphabetical order starting with Afghanistan and ending with Zimbabwe. Figure 6-1 is a partial listing of mailing conditions and postage rates for Great Britain and Northern Ireland as they appear in the IMM. The G3 listed at the top of the page is a letter-number combination that refers to a grid square on the World Map of the IMM. Refer to the World Map Index for the exact location of any country.

## COUNTRIES NOT LISTED

Not all countries or localities are listed in the Individual Country Listings. Notice that in figure 6-2 the locality of Alderney, Channel Islands is shown. This means that if an article is addressed for delivery in Alderney, Channel Islands, the conditions and rates listed for Great Britain and Northern Ireland also apply for Alderney, Channel Island. But, what if you did not know that Alderney, Channel Island is listed under Great Britain? If a country or locality is not listed in the Individual Country Listings, then go to the Index of Countries and Localities. This is an alphabetical list of countries and localities not listed individually. Figure 6-2 shows some of the countries and localities listed in this section. The country that you should look under in the Individual Country Listings is shown to the right in parentheses.

## CATEGORIES OF INTERNATIONAL MAIL

International mail is comprised of three categories:

Postal Union

Parcel Post

Express Mail International Service (EMIS). This service is not available at military post offices.

*Q6-1. Mail addressed to a foreign country is identified as what type of mail?*

*Q6-2. Each time an article addressed to a foreign country is presented for mailing, to what publication must you refer?*

*Q6-3. To locate a country not listed separately in the Individual Country Listings, you should refer to what section of the IMM?*

*Q6-4. What are the three categories of international mail?*

Now turn to appendix 1 to check your answers.

## POSTAL UNION MAIL

---

**Learning Objective:** *Identify the classes of, and the procedures for processing Postal Union mail.*

---

Postal Union mail consists of two classes, broken down into subclasses. These classes and their subclasses are as follows:

LC—an abbreviation of the French words *Lettres et Cartes* (Letters and Cards). This mail includes postal and post cards, aerogrammes, letters, and letter packages. Of the two classes of Postal Union mail, personal correspondence can only be enclosed in the LC subclass of letters and letter packages.

AO—an abbreviation of the French words *Autres Objets* (Other Articles). This mail includes printed matter (books, newspapers, magazines, sheet music, and publisher's periodicals, also catalogs and directories), matter for the blind, and small packets.

## PROHIBITIONS AND RESTRICTIONS

The first thing you will have to determine about an article presented for mailing is whether or not it is mailable. All articles that are nonmailable in the domestic mail are prohibited in the international mail. Refer to the Individual Country Listings section of the IMM and Module C of the DMM. Certain other articles are prohibited or restricted in postal union mail to some or all countries.

Great Britain and Northern Ireland International Mail Manual

**Country Conditions for Mailing G3 Great Britain and Northern Ireland**  
(Includes England, Scotland, Wales, Northern Ireland, Guernsey, Jersey, Alderney, Sark, and the Isle of Man)

**Prohibitions (130)**  
Any postal item containing enclosures addressed to different persons at different addresses.  
Arms and parts of arms, except as noted under Observation #5 below.  
Articles, goods infringing British trademarks or copyright laws.  
Cards decorated with mica or ground glass or similar materials unless they are placed in envelopes.  
Citizens Band Radios, walkie-talkies, microbugs, and radio microphones that are capable of transmitting on any frequency between 26.1 and 29.7 MHz and 88 to 108 MHz per second.  
Goods made in foreign prisons, except for non-commercial purpose or of a kind UK.  
Horror comics and matrices.  
Obscene articles, prints, paintings, cards.  
Perishable infectious biological substances.  
Seal skins except those from an accepted Switchblade knives.

**Restrictions**  
Coins, banknotes, currency notes (paper payable to bearer, traveler's checks), unmanufactured platinum, gold, silver jewelry, and other valuable articles, registered letter packages or insured.  
Foods or beverages to which any preservative substance has been added must conform to regulations for importation.  
Live bees.  
Live queen bees must be accompanied by a UK Government Agricultural health certificate issued by the appropriate Department of the country of origin and free of disease.  
Meat, meat products, and animal products (sausage and dried milk require import appropriate UK Agricultural Department).  
Plants and parts of plants require import appropriate Agricultural Department.

**Observations**  
1. The following is a list of the names of names in Northern Ireland. The Court letters. The geographic identifiers should address mail to Northern Ireland:

**ANTRIM:** Downpatrick, Antrim, Killybegs, Ballymena, Newcastle, Belfast, Newry, Carrickfergus, Newtownards, Larne, LONDONDERRY: Coleraine, Lisburn, Killea, Portrush, Toomebridge, Whitehead, Londonderry, DOWN: Magherafelt, Banbridge, Portlaoise, Bangor.

532

IMM Issue 23, July 1, 2000

**Individual Country Listings**

POSTAGE RATES Letters and Letter Packages (220)			
Ounces not over	Rate	Ounces not over	Rate
0.5	\$0.60	16.5	\$13.40
1.0	1.00	17.0	13.80
1.5	1.40	17.5	14.20
2.0	1.80	18.0	14.60
2.5	2.20	18.5	15.00
3.0	2.60	19.0	15.40
3.5	3.00	19.5	15.80
4.0	3.40	20.0	16.20
4.5	3.80	20.5	16.60
5.0	4.20	21.0	17.00
5.5	4.60	21.5	17.40
6.0	5.00	22.0	17.80
6.5	5.40	22.5	18.20
7.0	5.80	23.0	18.60
7.5	6.20	23.5	19.00
8.0	6.60	24.0	19.40
8.5	7.00	24.5	19.80
9.0	7.40	25.0	20.20
9.5	7.80	25.5	20.60
10.0	8.20	26.0	21.00
10.5	8.60	26.5	21.40
11.0	9.00	27.0	21.80
11.5	9.40	27.5	22.20
12.0	9.80	28.0	22.60
12.5	10.20	28.5	23.00
13.0	10.60	29.0	23.40
13.5	11.00	29.5	23.80
14.0	11.40	30.0	24.20
14.5	11.80	30.5	24.60
15.0	12.20	31.0	25.00
15.5	12.60	31.5	25.40
16.0	13.00	32.0	25.80

**Weight Limit—64 ounces (4 lbs.)**

GLOBAL PRIORITY MAIL (228)			
Flat-Rate Envelope	Variable Weight Option	Weight Level	Rate
Small \$5.00		0.5 lb.	\$8.00
		1.0 lb.	13.00
		1.5 lbs.	18.00
		2.0 lbs.	21.00
		2.5 lbs.	25.00
		3.0 lbs.	28.00
		3.5 lbs.	32.00
		4.0 lbs.	34.00

**Weight Limit: 4 pounds**

DIRECT SACK TO ONE ADDRESSEE — M-BAGS (230)			
Type of Printed Matter	Surface	Rate Per Pound	Face
Regular Printed Matter, Catalogs and Directories	\$1.45	\$4	\$4
Books, Sheet Music and Publishers' Periodicals	\$0.79		

**Weight Limits: Minimum: 11 lbs.; Maximum: 66**

**Great Britain and Northern Ireland**

Printed Matter, Matter for the Blind, Small Packets (240)							
AIR				SURFACE			
All Classes	Weight Not Over	Regular Matter	Books & Sheets	Printed Music	Small Packets	Rate	Rate
\$0.90	0	1	\$0.70	\$2.24	\$0.38	\$0.70	
1.32	0	2	1.04	2.24	0.48	1.04	
1.74	0	3	1.30	2.24	0.62	1.30	
2.16	0	4	1.45	2.24	0.72	1.45	
3.00	0	6	1.98	2.24	0.91	1.98	
3.84	0	8	2.48	2.24	1.10	2.48	
4.68	0	10	2.98	2.24	1.30	2.98	
5.52	0	12	3.47	2.24	1.49	3.47	
6.36	0	14	3.97	2.24	1.68	3.97	
7.20	0	16	4.48	2.24	1.87	4.48	
8.04	1	2	4.84	3.97	2.05	4.84	
8.88	1	4	5.20	3.97	2.23	5.20	
9.72	1	6	5.56	3.97	2.41	5.56	
10.56	1	8	5.92	3.97	2.59	5.92	
11.40	1	10	6.28	3.97	2.77	6.28	
12.24	1	12	6.64	3.97	2.95	6.64	
13.08	1	14	7.00	3.97	3.13	7.00	
13.92	1	16	7.36	3.97	3.31	7.36	
14.76	2	8	8.68	5.35	4.46	8.68	
15.60	2	10	9.66	5.35	4.46	9.66	
16.44	2	12	10.64	6.73	5.61	10.64	
17.28	2	14	11.62	6.73	5.61	11.62	
18.12	3	8	11.98	8.11	6.76	11.98	
19.00	3	10	12.34	8.11	6.76	12.34	
19.88	3	12	12.70	8.11	6.76	12.70	
20.76	4	8	14.28	8.11	6.76	14.28	4 lb. max.
21.64	4	10	14.64	8.11	6.76	14.64	
22.52	4	12	15.00	8.11	6.76	15.00	
23.40	5	0	16.56	9.49	7.91	16.56	
24.28	5	2	16.92	9.49	7.91	16.92	
25.16	6	0	18.48	10.87	9.06	18.48	
26.04	6	2	18.84	10.87	9.06	18.84	

**SPECIAL SERVICES**

**CERTIFICATE OF MAILING** See 313 for fees.

**COD AND CERTIFIED** NOT for International Mail

**INSURANCE (320)**  
Available for Parcel Post only (see 324.2 for required markings)

Insured Amount not over	Fee	Insured Amount not over	Fee
\$50	\$1.60	\$800	\$8.80
\$100	\$2.50	\$900	\$9.70
\$200	\$3.40	\$1000	\$10.60
\$300	\$4.30		
\$400	\$5.20	Add \$0.90 for each additional \$100	
\$500	\$6.10	or fraction of insurance coverage.	
\$600	\$7.00		
\$700	\$7.90	\$2020 max.	\$20.50

**INTERNATIONAL BUSINESS REPLY SERVICE (390)**  
Fee: Envelopes up to 2 ounces \$1.00 Cards \$0.80

**INTERNATIONAL MONEY ORDERS (391)**

Amount of Money Order	Fee
Maximum Amount Available: \$200	\$8.50

**RECORDED DELIVERY (385)** NOT available

**REGISTERED MAIL (330)**

Available: Letter Class, All Printed Matter, Small Packets, and Matter for the Blind	Fee: \$6.00	Maximum Indemnity: \$40.45
--	-------------	----------------------------

**RESTRICTED DELIVERY (350)** NOT available

**RETURN RECEIPT (340)**  
Available for Registered Mail and Insured Parcels **Fee: \$1.25**

**SPECIAL DELIVERY (370)** **Fee: \$2.35**

**SPECIAL HANDLING (380)**  
Available for surface mail

Weight	Fee
Not over 10 lbs.	\$5.40
Over 10 lbs.	\$7.50

534

IMM Issue 23, July 1, 2000

Figure 6-1.—An example of an individual country's conditions for mailing.

**Valuable Items**

Certain valuable articles are prohibited in postal union mail unless registered. Articles that must be registered include the following:

Coins, banknotes, or currency notes (paper money)

Jewelry (inexpensive jewelry, such as tie clasps, costume jewelry, and so forth, containing little or

# Index of Countries and Localities

Postage rates and other mailing conditions for these places appear in the Individual Country Listings (ICLs). Localities that are not listed separately in the ICLs under their own heading are listed with the country identified in parentheses. Page numbers are provided for easy reference for countries which have an individual country listing. For the conditions of mailing for U.S. Possessions and Trust Territories, see DMM G011.2.0.

Country Name	Page Number	Country Name	Page Number
Abu Dhabi (United Arab Emirates)	933	Bangladesh	331
Admiralty Islands (Papua New Guinea)	762	Banks Island (Vanuatu)	943
Afghanistan	281	Barbados	335
Aitutaki (Cook Islands) (New Zealand)	738	Barbuda (Antigua and Barbuda)	299
Ajman (United Arab Emirates)	933	Barthelemy (Guadeloupe)	546
Aland Island (Finland)	498	Belarus	338
Albania	283	Belgium	341
Alderney, Channel Islands (Great Britain)	532	Belize	344
Algeria	286	Benin	347
Alhucemas (Spain)	861	Bermuda	350

Figure 6-2.—An example of an index of countries and localities.

no precious metal is not considered to be jewelry within the meaning of this section)

Manufactured and unmanufactured platinum, gold, or silver

Precious stones or jewels and other valuable articles

Traveler’s checks

Instruments payable to bearer

## Individual Country Prohibitions and Restrictions

If an article is not prohibited or restricted in general, you should refer to “Prohibitions and Restrictions” under the Country Conditions for Mailing section in the Individual Country Listings section of the IMM. Certain articles may be mailable to some countries but not to others. If an article is prohibited by the country of address, it may not be accepted for mailing. If an article has restrictions placed on it, advise the mailer of these restrictions. The country of address may return or keep articles prohibited or restricted. Do NOT attempt to inform

customers whether or not items are subject to customs duty, however, because the possibility exists that customs duties will be charged, you may suggest to customers that they inform addressees in advance of the items they intend to mail.

## ENVELOPES

Envelopes used for mail addressed to foreign countries must meet the following conditions:

Light in color (not a brilliant color). The color must be light enough so that the address and postmark are legible.

Rectangular in shape.

A minimum of 5 1/2 inches in length by 3 1/2 inches in height.

Envelopes should be constructed of paper strong enough to withstand normal handling. Highly glazed paper or paper with an overall design is not acceptable.

## PACKAGING REQUIREMENTS

The mailer is responsible for properly packaging and preparing international mail. However, you

should be able to advise mailers as to the proper packaging of articles, or refer them to the applicable section of the IMM (part 120). In preparing an article for mailing, you should advise mailers to:

Use strong envelopes or durable packaging material

Consider the type of article being mailed

Take into account the distance the article must travel to reach the addressee

### **Other Articles**

Printed matter, matter for the blind, and small packets must be prepared so that the contents may be easily inspected. AO items must be placed either in wrappers, between cardboard, or in bags, boxes, envelopes, or containers. Dangerous fasteners may not be used. String or twine may be used to secure articles as long as they can be easily untied.

### **Fragile Items**

Articles of glass or other fragile materials must be packed in boxes of metal, wood, strong plastic, or fiberboard. If a fiberboard box is used, it should have a test board strength of at least 275 pounds. Enough packaging should be used to prevent the contents from moving about or coming in contact with other articles or with any side of the box.

### **ADDRESSING**

The entire right half of the address side of the envelope, package, or card should be set aside for the following:

Destination address

Postage

Labels

Postal endorsements

International mail articles must be addressed legibly using roman letters and arabic numerals. Each line of the address should be placed lengthwise on the article and must be written in ink or typewritten; pencil is not acceptable.

The name and address of the addressee must be written precisely and completely. The name of the city or post office and country of destination must be in capital letters. When mail is sent to towns and cities, the house number and street address or box number

must be included. The postal delivery zone numbers must be included, if known. Mail may not be addressed to BOXHOLDER or HOUSEHOLDER.

Addresses in Russian, Greek, Arabic, Hebrew, Japanese, or Chinese characters must bear an interlined translation of the names of the post office, province, and country of destination in English. If the English form of the name is not known, the foreign spellings should be shown in roman letters, print, or script.

The complete return address of the sender must be shown in the upper left corner of the address side of the mail. It must be placed so as not to affect either the clarity of the address or the application of service labels or notations (postmarks and so forth).

### **PAYMENT OF POSTAGE**

Each international item must be fully prepaid to assure prompt dispatch and to avoid the post office of delivery from collecting charges from the addressee.

Postage should be placed on the address side of the article in the upper - right corner. Care should be taken when the stamps are placed on the article to make sure they are securely attached. If the postage stamps for some reason are not securely attached and are lost in transit, this could cause the article to become postage due, causing the addressee to pay additional postage to receive it.

Postage may be paid by U.S. postage stamps or by meter stamps of a bright red color. Airmail stamps may be used on airmail articles only, and special delivery stamps may be used only for payment of special delivery fees.

### **LETTERS AND LETTER PACKAGES**

Letters and letter packages are items of mail containing personal current correspondence. Personal correspondence includes any item that is handwritten, typewritten, or recorded.

Any article that is otherwise acceptable in postal union mail may be mailed at the letter rate of postage as long as the weight and size limits are met. Refer to the Individual Country Listings section in the IMM for current postage rates.

### **Merchandise in Letters**

Dutiable merchandise may be sent in letters and letter packages unless the country of address does not

allow such a practice. If dutiable merchandise is sent in a letter or letter package, the mailer must comply with any special instructions for forms required. Refer to the “Customs Forms Required” and “Observations” sections in the Individual Country Listings. Because PS Form 2976 generally indicates that dutiable merchandise is enclosed, it should not be placed on letter mail articles when the mailer knows the contents are not dutiable.

### Weight and Size Limits

The weight limit for letters and letter packages to all countries is 4 pounds except for registered letters and letter packages to Canada where the weight limit is 66 pounds. The size limits for envelopes and packages not in the form of a roll are as follows:

Minimum-length and height: 5 1/2 by 3 1/2 inches

Minimum depth (thickness): .007 inch

Maximum length: 24 inches

Maximum combined length, width, and thickness: 36 inches

The size limits for articles that are in the form of a roll are as follows:

Minimum length: 4 inches

Minimum length plus twice the diameter combined: 6 3/4 inches

Maximum length: 36 inches

Maximum length plus twice the diameter combined: 42 inches

See figure 6-3 on how to measure an article in roll form.

An additional fee (surcharge) is charged on all outgoing air and surface letters weighing 1 ounce or less and exceeding any of the following size limits:

Maximum length: 11 1/2 inches

$$\text{LENGTH} + \text{DIAMETER} + \text{DIAMETER} = \text{MAXIMUM MEASUREMENT}$$

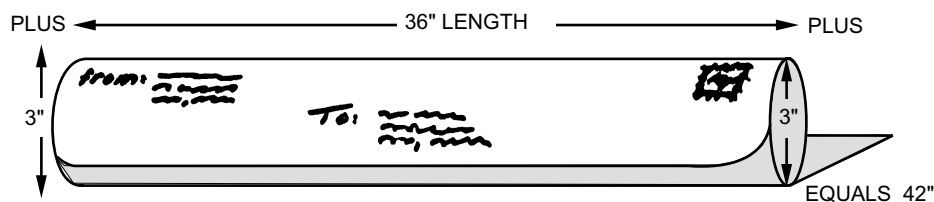

Figure 6-3.—Measuring an article in roll form.

Maximum height: 6 1/8 inches

Maximum thickness: 1/4 inch

Length divided by its height results in an aspect ratio that is less than 1.3 or more than 2.5

### Preparation for Mailing

Letters and letter packages may be sealed or left unsealed unless registered; then, they must be sealed.

### Marking and Endorsing

Articles other than ordinary letters should be endorsed LETTER or LETTRE on the address side. In any case the article should be endorsed, if, because of the article’s size or manner of preparation, it may be mistaken for an article of another type. If the article is to be sent airmail, the mailer should mark it “PAR AVION” or affix PS Label 19-A, PAR AVION Airmail or PS Label 19-B, Air Mail Par Avion (see figure 6-4), on the front and back of the article.

### POSTAL CARDS AND POSTCARDS

Postal cards and postcards consist of cards sent without a wrapper or envelope. Folded (double) cards



Figure 6-4.—An example of PS Label 19-A and 19-B used on international mail.



must be mailed in envelopes at the letter rate of postage. Reply cards are not accepted in international mail except as provided in the IMM, Chapter 1, Section 132.2.

### **Preparation for Mailing**

The basic requirement for postcards accepted in international mail is the same as those for domestic mail. Postal cards and postcards should be constructed of paper strong enough to withstand normal handling in the postal system. Highly glazed paper, or paper having an overall design, is not acceptable. Only light-colored cards should be used. Brilliant colors may not be used. Privately made postcards, except picture post cards, must have the word "Postcard" printed on them.

The right half of the address side of the card is reserved for the address of the addressee and postal notations or labels. The mailer may use the back and the lower left half of the address side for correspondence or writing. Postage must be placed on the address side in the upper right corner of the card. Undeliverable postcards are disposed of in the country of address unless they bear the name and address of the mailer.

### **Attachments**

The following items may NOT be attached to postcards:

Cloth, embroidery, or spangles

Samples of merchandise

The following items may be glued on the left half of the address side of a card, or on the side opposite the address side, if they are made of paper or other thin material, and stick completely to the card:

Clippings of any kind

Illustrations or photographs

Labels other than address labels

Stamps of any kind, except that stamps that are likely to be confused with postage stamps may be placed only on the back

Address labels or address tabs that may be glued to the address side of the card

### **Weight and Size Limits**

Postcards should be approximately the same quality and weight of a postal card. Remember that postal cards are those cards issued and sold by the USPS.

The size limits for postcards are minimum-3 1/2 by 5 1/2 inches and maximum-4 1/4 by 6 inches.

### **AEROGRAMMES**

Aerogrammes are air letter sheets that can be folded into the form of an envelope and sealed. Tape or stickers cannot be used to seal aerogrammes. Military post offices can order aerogrammes from the USPS for resale to postal customers. Aerogrammes can be sent to all countries and can be sent registered mail on payment of the registry fee. Enclosures are not authorized in aerogrammes. Aerogrammes that do contain enclosures are treated as regular airmail letters. Aerogrammes with enclosures on which postage has not been paid at airmail letter rates must be returned to the sender for additional postage or, if there is no return address, forwarded to the international exchange office (IEO) marked, "postage due."

### **PRINTED MATTER**

For postal purposes, printed matter is defined as anything that has been reproduced on paper in several identical copies by any process other than handwriting or typewriting.

For mailing purposes, printed matter is divided into three types (1) regular printed matter, (2) books and sheet music, and (3) publisher's periodicals.

#### **Regular Printed Matter**

Regular printed matter includes all printed matter other than books, sheet music, and publisher's periodicals.

#### **Books and Sheet Music**

Printed matter of this type includes books that have 8 or more printed pages. The printed matter should consist wholly of reading matter or scholarly bibliography, or reading matter with incidental blank spaces for notations. It must not contain any advertising matter, other than incidental announcements of books, in the form of book pages.

Some bound and loose enclosures are permissible under the provisions of Module E of the DMM.

### **Publisher's Periodicals**

Publisher's periodicals are domestically approved Periodicals Mail publications (refer to Module E of the DMM). Only publishers and registered newsagents may mail these publications at the Periodicals rates. When individuals present publisher's periodicals for mailing, they must be mailed at regular printed matter postage rates.

### **Printed Matter Restrictions**

The following items may NOT be mailed as printed matter:

Documents reproduced by means of a typewriter of any kind

Copies produced by tracing, handwriting, or typewriting on any type of machine

Copies produced by means of stamps with or without movable type

Stamps or forms of prepayment (canceled or not), including Internal Revenue strip stamps or any printed paper representing a monetary value

Articles of stationery, in quantities of more than one article per package. This includes letterheads, billheads, unused cards, diaries, checkbooks, memo pads, and other similar items having some printing on them, but on which additional entries are intended to be made

Films, negatives, slides, microfilm, and microfiche

Sound or video recordings

Framed photographs or certificates

Playing cards

Exceptions: the following items can be mailed as printed matter if they otherwise conform to the prescribed conditions of form and makeup, even though they may be wholly or partly handwritten or typed:

Manuscripts of works or for newspapers

Musical scores in manuscripts

### **Endorsements**

Mailers must mark PRINTED MATTER on the address side of the envelopes or wrappers of packages paid at regular printed matter rates. On printed matter mailed at other than the regular rates, the marking must include its category, for example: PRINTED MATTER-BOOKS or PRINTED MATTER—SHEET MUSIC. For further information, refer to chapter 2 of the IMM.

### **Weight and Size Limits**

The weight limits for printed matter vary from 4 to 30 pounds depending on the country of address. Refer to the Individual Country Listings section of the IMM for weight limits.

Size limits for printed matter are the same as for letters, letter packages, and postcards.

### **MATTER FOR THE BLIND**

Articles acceptable as matter for the blind may be sent surface international mail free of postage. Airmail articles accepted as matter for the blind are charged AO air rates listed in the Individual Country Listings section of the IMM.

The following articles may be accepted in international mail as matter for the blind:

Books, periodicals, and other matter (including unsealed letters) impressed in Braille, or other special type for the use of the blind

Plates for embossing literature for the blind

Disks, tapes, or wires bearing voice recordings and special paper intended solely for the use of the blind, provided they are sent by or addressed to an officially recognized institution for the blind

Sound recordings or tapes that are mailed by a blind person

Items listed in Module E of the DMM

### **Weight and Size Limits**

The maximum weight limit for matter for the blind to all countries is 15 pounds. Size limits for matter for

the blind are the same as for letters, letter packages, and printed matter.

### **Preparation for Mailing**

Articles accepted, as matter for the blind, must be prepared in such a way that the contents are protected but inspection of the contents is not hindered. Matter for the blind must not be sealed, even if registered. The word FREE must be placed in the upper - right corner, immediately above the words MATTER FOR THE BLIND, on surface mail only. On airmail articles, the words, "MATTER FOR THE BLIND," must be placed in the upper - right corner near the postage stamps or meter strip. Airmail articles should have PS Label 19-A or PS Label 19-B affixed or the words PAR AVION written on the front and back lower left side. If the mail being accepted is from an officially recognized institution for the blind, the name of the institution must appear in the return address for the following items:

Discs, tapes, or wires bearing voice recordings

Special paper intended solely for the use of the blind

### **SMALL PACKETS**

Small packets offer a convenient and economical way for sending small quantities of merchandise at a rate cheaper than parcel post rates. Commercial samples and documents that do not have the character of current and personal correspondence may also be sent in small packets. The following items may also be sent as small packets whether or not they have the character of correspondence:

Phonograph records

Sound tapes and cassettes

Video tapes and cassettes

Video disks

Motion picture film

Magnetic tapes

Automatic data processing (ADP) cards

QSL cards (these are cards sent by a ham radio operator to confirm a radio contact) may be sent in small packets, if they bear no notations having the character of correspondence.

### **Small Packet Restrictions**

Small packets may NOT contain the following:

Written communications having the character of current personal correspondence

Coins, banknotes, paper money, canceled or uncanceled postage stamps, or values payable to the bearer. EXCEPTION: Canceled or uncanceled postage stamps are mailable to Canada in small packets.

Manufactured or unmanufactured platinum, gold, or silver

Precious stones, jewelry, or other precious items.

### **Enclosures Permitted in Small Packets**

A simple invoice and a slip showing the names and addresses of the mailer and addressee of the packet may be enclosed.

### **Weight and Size Limits**

Weight limits for small packets are 4 pounds for most countries, 1 pound and 2 pounds to some. Refer to the Individual Country Listings.

### **Preparation for Mailing**

Small packets can be sealed or left unsealed whether or not registered. Small packets are subject to postal inspection and must be prepared in such a way that the contents are protected, but inspection of the contents is not hindered. All small packets must bear a customs form PS Form 2976 or PS Form 2976-A (discussed later in this chapter).

### **Endorsements**

The mailer must mark in bold capital letters on the address side, the words SMALL PACKET. Small packet can also be written in a language known in the country of address as follows:

PETIT PAQUET (French)

PACKCHEN (German)

PEQUENO PAQUETE (Spanish)

If sent airmail, the mailer must place PS Label 19-A or PS Label 19-B, or add the words PAR AVION (in blue) on the left side of the front and on the back of the item.

- Q6-5. Name the two classes of postal union mail.
- Q6-6. Before accepting postal union mail, you must first ensure that the article presented for mailing is mailable. (True/False)
- Q6-7. A letter package containing coins, banknotes, or paper money must have what special service applied to the article?
- Q6-8. List the criteria for envelopes that are addressed to a foreign country.
- Q6-9. List the types of postal union mail that must be prepared in such a way that the contents may be easily inspected.
- Q6-10. When postal union mail is mailed to a foreign country the address must be written precisely and completely. (True/False)
- Q6-11. When meter stamps are used as a payment of postage for international mail, what color of ink must be used?
- Q6-12. What PS labels identify international airmail service?
- Q6-13. What is the minimum size limit for a postcard mailed to a foreign country?
- Q6-14. What are aerogrammes and how are they used?
- Q6-15. What amount of postage, if any, is paid for an item mailed as matter for the blind and sent surface international mail?
- Q6-16. Written correspondence may be enclosed in small packets. (True/False)

Now turn to appendix 1 to check your answers.

## PARCEL POST

---

**Learning Objective:** *Recognize the procedures for accepting and processing Parcel Post Mail.*

---

This section describes the conditions for mailing international parcel post. International parcel post is a separate category from postal union mail and should be treated as such. Parcel post is similar to domestic Standard Mail (B). That is, merchandise is permitted, but written communications having the nature of current and personal correspondence are prohibited.

## PARCEL POST SERVICE

Parcel post is available to most countries. The requirements for acceptance and handling of international parcel post are similar for all countries. However, acceptance procedures are determined by individual bilateral agreements. The Parcel Post section in the Individual Country Listings of the IMM indicates whether or not parcel post service is available to a certain country. If parcel post service is available, you can also find information on related services and specific mailing conditions in this section.

## PARCEL POST RESTRICTIONS

Certain types of articles are prohibited or restricted in parcels to all countries. Remember that all articles prohibited in the domestic mails are also prohibited in the international mails.

### Valuable Articles

The mailing of valuable articles as parcel post is subject to the same restrictions as Postal Union mail.

### Information Concerning Restricted Articles

Information on articles that are prohibited or restricted by individual countries appear under "Prohibitions and Restrictions" in the Country Conditions for Mailing section of the Individual Country Listings. These prohibitions and restrictions are based on information furnished by the countries concerned.

Parcels containing articles that are prohibited by the destination country must not be accepted for mailing. For a parcel known to contain articles that are restricted by the destination country, the mailer must be informed of the restrictions and be informed that the contents are subject to the import rules of the country concerned.

### Enclosures or Attachments of Communications

Except for parcels addressed to Canada or Switzerland, communications of a personal nature must NOT be attached to or enclosed in a parcel. If you find such communications attached, remove and handle as a separate piece. If the item cannot be removed, the entire parcel must be returned to the mailer.

**EXCEPTIONS:** A file or collection of out-of-date correspondence that has served its original purpose may be enclosed in a parcel. Also, a parcel can contain an invoice as long as the invoice is limited to the particulars that constitute an invoice.

## POSTAGE RATES

Rate tables are shown in the Individual Country Listings under the Parcel Post heading of each country to which the service is available. The column to the left shows air rates and the column to the right shows the surface rates. The center column shows the weight. See figure 6-1.

### Placement of Postage

Place stamps or a meter strip for payment of postage and fees in the upper - right corner of the address side of the parcel.

## WEIGHT AND SIZE LIMITS

The maximum weight limit for parcel post varies from country to country.

A parcel must not exceed the maximum size limits for the country to which it is addressed. International parcels, except circular objects, are measured in the same manner as domestic parcels.

Always, refer to the Parcel Post section of the Individual Country Listings, for maximum weight and size limits.

### Measuring Circular Objects

Circular objects, such as tires, coils of rope, hose, wire, and so forth, are measured using a different method when sent as international mail. A circular object, whether there is an open space in the center or not, is measured around its entire girth in the direction of the diameter as shown in figure 6-5. This measurement must not exceed 64 inches.

### Measuring Rectangular Parcels

Rectangular parcels presented for mailing as international mail are measured the same as domestic parcels. The size restrictions for rectangular parcels accepted in international mail are as follows:

Minimum length and width-5 1/2 by 3 1/2 inches

Maximum length-42 inches

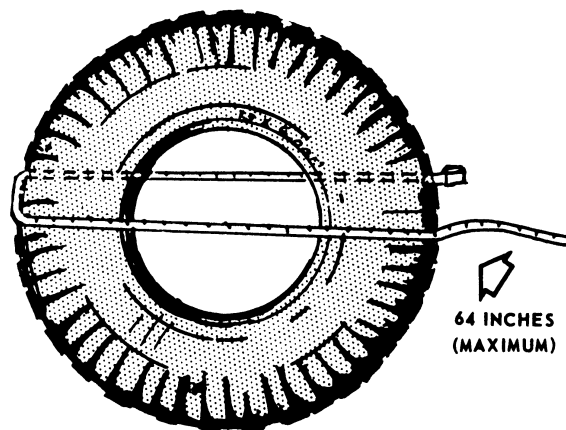

Figure 6-5.—Measuring circular objects.

Maximum length and girth combined-79 inches

## PACKAGING REQUIREMENTS

Every parcel must be securely and substantially packaged. When preparing a package for mailing, the sender must consider the nature of the contents, the climate, the length of the journey, and the numerous handlings involved in the conveyance of international mail.

Even though the mailer is responsible for properly enclosing, packaging, and sealing the parcel, the accepting clerk is responsible for informing mailers of the requirements so they can meet their responsibilities.

### Acceptable Containers

Ordinary paperboard containers are not acceptable. Items must be packaged in one of the following containers:

Canvas or similar material

Double-faced corrugated or solid (minimum 275-pound test) fiber boxes or cases

Strong wooden boxes made of lumber at least 1/2 inch thick or plywood of at least three plies

Heavy wrapping paper or waterproof paper can only be used as the outside covering of a parcel. If otherwise acceptable, boxes with screwed or nailed on lids and bags closed by sewing may be used. Heavy objects must be surrounded with other contents or packaging material to prevent their shifting within the parcel.

## Addressing

Each parcel accepted must bear the name and address of the mailer and of the addressee. The names and addresses must be written legibly and correctly on the parcel itself or on a gummed label affixed to the parcel. The address of the mailer and addressee should also be written on a separate piece of paper and enclosed in the parcel.

The name of the city or post office and country of address must be written in full, in capital letters. If a postal delivery zone number is known, it should be included. The country's name must be the last line of the address. Sufficient space must be left on the outside wrapper for stamps, labels, and postal service endorsements.

Do not accept parcels when:

Addressed to a person in one country "in care of" a person in another country.

The name of the mailer or addressee is in initials, unless the initials are the adopted trade name of the mailer or addressee.

The addresses are written in pencil.

## Sealing

All international parcels must be sealed. Senders must seal their own parcels. Wax, gummed-paper tape, nails, screws, wire, metal bands, or other materials can be used to seal parcels. The seal must be sufficient to allow detection of tampering.

## TRANSPORTATION OF INTERNATIONAL MAIL

All categories and related classes of international mail are transported by either AIR or SURFACE carrier. Each Individual Country Listing shows the price for both airmail and surface rate under the desired class of mail.

*Q6-17. When accepting a parcel post package addressed to a foreign country, you should refer to what part of the IMM for information about prohibitions and restrictions?*

*Q6-18. What two countries allow personal correspondence to be attached to or enclosed in a parcel post package?*

*Q6-19. Lists by form number the two customs declarations used for international mail.*

Now turn to appendix 1 to check your answers.

## CUSTOMS FORMS AND PROCEDURES FOR INTERNATIONAL MAIL

---

**Learning Objective:** *Identify the customs declarations used for international mail and procedures to follow when customs duty has been assessed on dutiable articles.*

---

Merchandise sent to an international country may be subject to import duties and must have a customs declaration form attached. In this section you will learn which customs declaration forms to use, and how to complete them. You will also become familiar with how to process customs duties assessed on items of foreign origin mailed from overseas activities to addresses in the U.S.

## CUSTOMS DECLARATIONS

Only two types of customs declarations (PS Form 2976 and PS Form 2976-A) are used on dutiable postal union and parcel post mail.

### PS FORM 2976

Each letter package containing merchandise, printed matter known to be dutiable in the country of address, or small packets (dutiable and nondutiable) must have a Customs Label, PS Form 2976, Customs - CN22 (old C 1) and Sender's Declaration (green label) (see figure 6-6) attached. PS Form 2976 must be completed and placed by the mailer on the address side of each article.

There are occasions when only the upper - left portion of the PS Form 2976 is placed on the outside of an article. This is usually when the addressee does not want the contents to appear on the outside of the article or the value of the article is more than \$400. In this case the mailer must complete PS Form 2976-A, Customs Declaration and Dispatch Note (see figure 6-7) and enclose the form inside the parcel.

### PS FORM 2976-A

PS Form 2976-A is used on all parcel post packages and in conjunction with PS Form 2976 as instructed in the previous paragraph. When completing this form, the mailer must describe in detail the contents of the parcel. Descriptions of a general nature are not acceptable. When completed, PS Form 2976-A should be placed in PS Form 2976-E and attached to the outside of the mailing container.

PCf0606

Figure 6-6.—An example of a PS Form 2976.

PCf0607

Figure 6-7.—An example of a PS Form 2976-A.

## PS FORM 2976-E ENVELOPE

PS Form 2976-E is a transparent plastic envelope that is attached to the outside of parcels. Customs Form 2976-A is enclosed in it for protection.

## CUSTOMS CHARGES

Articles of foreign origin may be subject to customs duty. These charges are collected only when

your ship or station is located in an area where the United States has customs jurisdiction (the 50 states, District of Columbia, and Puerto Rico). If your ship is in foreign waters, or if you are at a shore station located outside the customs jurisdiction of the United States, and articles assessed customs duty are received, the articles can be delivered without collection of the duty. If such articles bear Customs Form (CF) 3419-A, endorse the form DELIVERED OUTSIDE THE

CTUS and return the form to the issuing customs office as indicated on each customs form.

Articles with customs duty assessed will arrive endorsed to show the amount to be collected, and CF 3419-A, Mail Entry Customs, will be attached. The USPS assesses a fee that will be included within the total amount charged.

Notify the addressee of the assessed customs duty by preparing PS Form 3849 (Delivery Notice/Receipt), see figure 6-8. Customs duty is collected when delivery is made. Obtain the addressee's signature on the original CF 3419-A as well as on PS Form 3849 if the article is registered, certified, numbered insured, or Express Mail.

Custom duties collected must be exchanged for a USPS money order, fee payable by addressee, made payable to the appropriate accountable postmaster, (Postmaster, New York or Postmaster, San Francisco). Customs collections should be reported on PS Form 6019 (modified) prepared in duplicate (see figure 6-9).

All copies of the report will be signed by the person preparing the form and verified and signed by the COPE, MPO supervisor, reserve custodian, or postal officer. The original PS Form 6019, CF 3419-A, associated tapes (if any), and a USPS money order should be forwarded by First-Class USPS indicia mail to the Postmaster, New York for East Coast units, and NPFO San Diego for West Coast units. The duplicate of the report should be retained in the MPO files.

At domestic shore stations, parcels containing articles that were assessed customs duties are held at a civilian post office. The postmaster notifies the addressees, who must call at the post office and pay the duty before the parcels are delivered.

## **PREPAYMENT OF CUSTOMS DUTY ABROAD**

There are no provisions made for the prepayment abroad of customs charges on mail addressed for delivery in the United States.

If postal patrons desire information concerning rates of duty or other customs procedures, they should contact the nearest customs office or the COMMISSIONER OF CUSTOMS, U.S. CUSTOMS SERVICE, U.S. DEPARTMENT OF THE TREASURY, 1301 CONSTITUTION AVE NW, WASHINGTON DC 20229-0001.

## **REFUSAL OR PROTEST OF CUSTOMS CHARGES BY ADDRESSEE**

If the addressee in CONUS refuses to pay the customs duty, the parcel should be returned to the sender along with both copies of CF 3419-A. If the parcel was mailed from an MPO located overseas, and returned to the mailer at the overseas address, the serving MPO removes the CF 3419-A and endorses the parcel DELIVERED OUTSIDE THE CTUS. NOTE: Before giving the parcel back to the mailer, make sure a record is made that the article was returned to sender (RTS) for future inquiries of CF 3419-A. If the article was mailed aboard a U.S. ship or mobile unit that receives the returned parcel as the ship or mobile unit returns to CONUS, the customs duty must be paid by the mailer before delivery. If the mailer refuses, return the parcel and CF 3419-A, endorsed REFUSED to your servicing USPS mail recovery center. If the customer wishes to protest customs charges, refer to the instructions on the reverse side of CF 3419-A and IMM, part 713.

- Q6-20. If an article is assessed customs duty, what customs form will be attached?*
- Q6-21. To what office is the remittance of customs duty collected sent?*
- Q6-22. Customs duty collected is reported on what PS form?*
- Q6-23. What provisions, if any, are made to prepay customs duty in advance at an overseas MPO?*

Now turn to appendix 1 to check your answers.

## **SPECIAL SERVICES**

---

**Learning Objective:** *Recall the special services available for international mail and the classes of mail for which they are available.*

---



In this section we will describe the special services that are available for international mail. Special services that are available for international mail are basically equal to those available for domestic mail.



United States Postal Service		Today's Date	Sender's Name
<b>Sorry We Missed You! We  Deliver for You</b>			
Item is at: <input type="checkbox"/> Post Office (See back)		Available for Pick-up After Date: _____ Time: _____	<b>We will redeliver or you or your agent can pick up. See reverse.</b>
<input type="checkbox"/> Letter <input type="checkbox"/> Large envelope, magazine, catalog, etc. <input type="checkbox"/> Parcel <input type="checkbox"/> Restricted Delivery <input type="checkbox"/> Perishable Item <input type="checkbox"/> Other: _____		<b>For Delivery:</b> (Enter total number of items delivered by service type) <b>For Notice Left:</b> (Check applicable item) <input type="checkbox"/> Express Mail (We will attempt to deliver on the next delivery day unless you instruct the post office to hold it.) <input type="checkbox"/> Certified <input type="checkbox"/> Recorded Delivery <input type="checkbox"/> Firm Bill	
Article Requiring Payment		Amount Due	
<input type="checkbox"/> Postage Due <input type="checkbox"/> COD <input type="checkbox"/> Customs   \$ _____			
<input type="checkbox"/> <b>Final Notice:</b> Article will be returned to sender on _____		Delivered By and Date	
PS Form <b>3849</b> , November 1999		102595-00-M-0892	<b>Delivery Notice/Reminder/Receipt</b>

**FRONT**

We will redeliver OR you or your agent can pick up your mail at the post office. (Bring this form and proper ID. If your agent will pick up, sign below in item 2, and enter agent's name here):

1.  a. Check all that apply in section 3; b. Sign in section 2 below; c. Leave this notice where the carrier can see it.	
2. Sign Here to Authorize Redelivery or to Authorize an Agent to Sign for You:	<b>Delivery Section</b>
3. <input type="checkbox"/> Redeliver (Enter day of week): _____  (Allow at least two delivery days for redelivery, or call your post office to arrange delivery.) <input type="checkbox"/> Leave item at my address  (Specify where to leave. Example: "porch", "side door". This option is not available if box is checked on the front requiring your signature at time of delivery.) <input type="checkbox"/> Refused <input type="checkbox"/> Forward <input type="checkbox"/> Return	Signature X  Printed Name _____ Delivery Address _____
PS Form <b>3849</b> , November 1999 (Reverse)	<b>USPS</b>  <b>5290 0021 7049 5026</b>

**BACK**

PCF0608

**Figure 6-8.—An example of a PS Form 3849 (front and back).**

Refer to the Individual Country Listings of the IMM for special services available for each country.

**CERTIFICATE OF MAILING**

Customers can purchase a certificate of mailing, PS Form 3817, when they send unregistered letters, letter packages, post/postal cards, printed matter

items, matter for the blind, and small packets; uninsured parcel post; or require a duplicate of an original certificate that pertained to a previously mailed item. A certificate of mailing cannot be obtained in combination with registered mail, insured parcel post, or recorded delivery service.

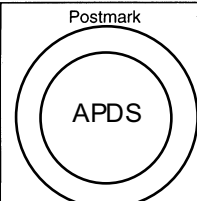
U.S. POSTAL SERVICE CUSTOMS COLLECTION MILITARY POST OFFICE (MPO) REPORT OF MONEY ORDER BUSINESS										
MPO Office ID No. (APO/UIC) 000019		Unit No.		Instructions: <b>See DOD 4525.6-M</b>						
Issue Office Address COMMANDING OFFICER USS UNDERWAY (CV-66) FPO AE 09561-0001			No Business was Conducted From _____ To _____							
			Transmitted under Registry No. RR 008 394 001 US		For Business of (Date) 23 JUN 00					
SECTION I MONEY ORDERS ISSUED			SECTION II PAID MONEY ORDERS AND CHECKS INCLUDED IN SUMMARY			SECTION III CASH SUMMARY				
Block Serial Nos. Used			Paid Money Orders			Debits		Amount		
From			Serial No.		Amount	1. Balance from Item 13 of Previous report				
Thru			1	8023614221	3 60	2. MO's issued (Amount Total Section I)				
No. Used			2	8023614229	7 30	3. Fees (Fees Total Section I)				
No. spoiled			3			4.				
No. issued			4			5.				
Amount			5			6. Shortage Correction*				
Fee			6			7. TOTAL DEBIT				18 40
TOTAL			7			Credits		Amount		
Block Serial Nos. Used			8			8. Paid money orders (Total Section II)				10 90
From			9			9. Checks as listed (Total Section II)				7 50
Thru			10			10.				
No. Used			11			11.				
No. spoiled			12			12. Overage Correction*				
No. issued			13			13. Balance carried to item 1 of next report				
Amount			14			14. TOTAL CREDIT				18 40
Fee			15			15.				
TOTAL			16			16.				
Block Serial Nos. Used			17			17.				
From			18			18.				
Thru			19			19.				
No. Used			TOTAL (To Item 8. Sec. III)			10 90	20.			
No. spoiled							21.			
No. issued			Checks				22.			
Amount			Serial No.	Symbol No.	Amount	23. Balance carried to item 1 of next report				
Fee			10578	5780	7 50	24.				
TOTAL						25. TOTAL CREDIT				18 40
GRAND TOTAL						26.				
NOTE:			TOTAL (To Item 9. Sec. III)			7 50	27.			
<ul style="list-style-type: none"> <li>Carry Grand Total Amount to Item 2, Section III</li> <li>Carry Grand Total Fees to Item 3, Section III</li> </ul>								* Attach copy of Form 1908, Financial Adjustment Memorandum		
Remarks:										
Certified to be correct:			Reviewed and Verified							
<i>Able B. Seaman</i> ABLE B. SEAMAN, PCSN (Military Postal Clerk/Grade)			<i>Jane B. Doe</i> JANE B. DOE, ENS, SC (Designated Officer/Grade)					Postmark 		

PS Form 6019, Jan. 1983

PCF0609

Figure 6-9.—An example of a completed modified PS Form 6019 (customs collection).

## INSURANCE

A mailer may purchase insurance coverage for parcels that may become lost, damaged, or rifled. Insurance coverage is available only for parcel post and only to certain countries. To determine if insurance service is available to a particular country, refer to the Special Services section of the Individual Country Listings of the IMM.

### Insurance Limits

The maximum amount for which a parcel may be insured varies from country to country. Maximum amounts for which a parcel may be insured are listed in the Special Services section of the Individual Country Listings of the IMM.

A parcel may not be insured for more than the declared value of the contents or for more than the maximum amount of coverage listed for the country of address. However, the mailer may insure a parcel for only part of the value of the contents, in which case only the fee covering the amount of insurance should be charged.

### Preparation of Insured Parcels

The general provisions for the preparation of ordinary parcels apply also to insured parcels. All international insured parcels must be sealed.

### Insurance Receipt

When you accept international mail and the mailer requests insurance, you must always issue a receipt. Since each international insured parcel must be assigned a number, PS Form 3813-P, Receipt for Insured Mail, Domestic-International, is used. PS Form 3813-P is completed just as it is for domestic mail (refer to chapter 4). The insured receipt provides proof of insurance coverage, evidence of mailing, and proof of payment of the applicable insurance fee.

When you have completed the receipt, advise the mailer to enter the name and address of the addressee on the back of the receipt. The mailer keeps the receipt in case there is a need to initiate an inquiry or file a claim concerning the parcel at a later date.

### Markings

Once you have completed calculating postage and fees, you must:

Tear off the numbered insurance label (PS Form 3813-P) and affix it to the parcel close to the address.

Indicate on the parcel the amount for which the parcel is insured. This amount must be written in ink and expressed in U.S. currency (figures) and special drawing rights (SDR) values. To convert U.S. currency into SDR equivalents, multiply the U.S. amount (rounded to the next full dollar) by the conversion rate, currently .7286. Indicate SDR values in figures only. See figure 6-10 for an example. Always refer to Exhibit 324.22 of the IMM for the current table to convert U.S. dollars to special drawing rights.

Enter the insured number, insured amount, and SDR equivalent on the PS Form 2976-A.

NOTE: In addition to the above markings, Section 324.3 of the IMM requires that parcels sent as insured mail be postmarked at all breaks (cuts or torn edges) of any gummed-paper strips used in sealing the parcel.

<p>INSURED VALUE \$100.00 (U.S.) 72.86 SDR</p>
--

Figure 6-10.—An example of U.S. currency and SDR value conversion for placement on a parcel.

## REGISTRY SERVICE

Registry service, as you know from chapter 5, is offered to postal customers for additional protection and security. A record of acceptance is kept at the office of mailing, and the addressee or an authorized agent at the office of delivery must sign for registered articles.

### Availability and Limits of Insurance

Registry service is available to most countries for all postal union mail. Registry service is NOT available for parcel post packages.

Indemnity for loss, damage, or rifling is \$40.45, except for Canada where the indemnity limit is \$1,000. If the mailings contain banknotes (cash), they are subject to a \$200 indemnity limit.

### Preparation for Mailing

Mailers must securely seal letters and letter packages that are presented for registration. If wax or

paper seals are used on envelopes, they must bear a distinctive mark that identifies the mailer. The wax or seals must be affixed in such a way to allow enough space at the intersecting flaps for postmarking. Self-sealing envelopes and items that appear to have been opened and resealed may NOT be registered. Matter for the blind presented for registration must NOT be sealed. Printed matter and small packets may be registered, whether sealed or not. You, as the accepting clerk, should check to see that an article is properly prepared before you accept it for registration.

### **Addressing**

The addresses on an article to be registered should be completed by the mailer in ink or typewritten. Mail on which the address is written in pencil or consisting of initials must NOT be accepted for mailing.

### **Registry Receipt**

A registry receipt is given to each customer who registers an article. PS Form 3806, Receipt for Registered Mail, is used for this purpose. PS Form 3806 is the same form that is used for domestic registered mail and is completed in the same manner as for domestic mail using the same type of registered numbers (PS Label 200).

### **Declaration of Value**

The mailer must declare the full value of each article presented for registration. The value must be declared so that you may identify valuable registered mail for record purposes. DO NOT regard the declared value as the amount of indemnity that will be paid in case of loss.

### **Endorsements**

The accepting clerk must:

Affix PS Label 200, Registered Mail, to the item in the lower - left corner of the address side and enter the number in ink on the mailing receipt (PS Form 3806).

Place PS Label 19-A or 19-B, Airmail, or the words PAR AVION on all registered items prepaid for air service.

Ensure endorsements for other special services requested by the sender are marked as required.

NOTE: Do not confuse the location or placement of international mail endorsements with those endorsements required on domestic packages. Remember, always check the Individual Country Listings of the IMM before accepting an article addressed to a foreign country.

### **Postmarking**

The last step is to postmark the article. Cancel the postage with the APDS (same method as domestic registered mail). Postmark letters twice on the back on the crossing of the upper and lower flaps with the APDS. If paste-on return receipts are used, postmark partially on the receipt and partially on the flaps of the letter. Letters sealed on the address side must be postmarked on the address side. Postmark printed matter and small packets on the address side if unsealed. If sealed, apply postmarks in the same place as for letters.

### **RETURN RECEIPT**

The form to use when a customer requests proof of delivery for an article being mailed to an international address is PS Form 2865, Return Receipt for International Mail (AVIS DE RECEPTION). Return receipts may only be purchased at the time of mailing and are available only to certain countries for registered, insured, and recorded delivery articles (refer to Section 211.5 of the IMM). By paying for a return receipt, the mailer will also know when the article was delivered. Not all countries require the addressee to sign a return receipt, some countries do not admit return receipts, and many restrict them to registered mail. Remember to always refer to the Individual Country Listing of the IMM to determine the availability of return receipts for a particular country.

### **Preparation of Return Receipt**

PS Form 2865 (see figure 6-11) is completed by both the mailer and the accepting clerk. The mailer completes the front of the form. Have the mailer enter the address to which the receipt is to be returned once the article has been delivered. The accepting clerk completes the top portion of the reverse side. The following blocks must be completed:

Block 1: If the article is registered (Article, Letter, Printed Matter, Other), Recorded Delivery or Express Mail check the applicable block.

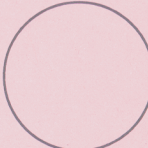
		<b>Return Receipt for International Mail</b> <i>(Registered, Insured, Recorded Delivery, Express Mail)</i>	
<i>Administration des Postes des Etats-Unis d'Amérique</i>			
<h1>Par Avion</h1>		Postmark of the office returning the receipt <i>Timbre du bureau renvoyant l'avis</i>	
Return by the quickest route (air or surface mail), a découvert and postage free.....		The sender completes and indicates the address for the return of this receipt. <i>(A remplir par l'expéditeur, qui indiquera son adresse pour le renvoi du présent avis.)</i>	
		Name or Firm ( <i>Nom ou raison sociale</i> )	
<i>A renvoyer par la voie la plus rapide (aérienne ou de surface), à découvert et en franchise de port.</i>		Street and Number ( <i>Rue et no.</i> )	
		City, State, and ZIP + 4 ( <i>Localité et code postal</i> )	
UNITED STATES OF AMERICA		Etats-Unis d'Amérique	
PS Form 2865, February 1997		<b>Avis de réception</b>	
		<b>CN07 (Old C5)</b>	

**FRONT**

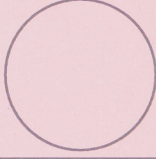
Completed by the office of origin. <i>(A remplir par le bureau d'origine.)</i>	Item Description (Nature de l'envoi)	<input type="checkbox"/> Registered Article ( <i>Envoi recommandé</i> )	<input type="checkbox"/> Letter ( <i>Lettre</i> )	<input type="checkbox"/> Printed Matter ( <i>Imprimé</i> )	<input type="checkbox"/> Other ( <i>Autre</i> )	<input type="checkbox"/> Recorded Delivery ( <i>Envoi à livraison attestée</i> )	<input type="checkbox"/> Express Mail International
	<input type="checkbox"/> Insured Parcel ( <i>Colis avec valeur déclarée</i> )	Insured Value ( <i>Valeur déclarée</i> )			Article Number		
	Office of Mailing ( <i>Bureau de dépôt</i> )					Date of Posting ( <i>Date de dépôt</i> )	
Completed at destination. <i>(A compléter à destination.)</i>	Addressee Name or Firm ( <i>Nom ou raison sociale du destinataire</i> )						
	Street and No. ( <i>Rue et No.</i> )						
	Place and Country ( <i>Localité et pays</i> )						
	<input type="checkbox"/> The article mentioned above was duly delivered. ( <i>L'envoi mentionné ci-dessus a été dûment livré.</i> )						Date
Signature of Addressee ( <i>Signature du destinataire</i> )					Office of Destination Employee Signature ( <i>Signature de l'agent du bureau de destination</i> )		
This receipt must be signed by: (1) the addressee; or, (2) a person authorized to sign under the regulations of the country of destination; or, (3) if those regulations so provide, by the employee of the office of destination. This signed form will be returned to the sender by the first mail. <i>(Cet avis doit être signé par le destinataire ou par une personne y autorisée en vertu des règlements du pays de destination, ou, si ces règlements le comportent, par l'agent du bureau de destination, et renvoyé par le premier courrier directement à l'expéditeur.)</i>							
PS Form 2865, February 1997 (Reverse)							

**BACK**

PC10611

**Figure 6-11.—An example of a PS Form 2865, Return Receipt for International Mail.**

Block 2: Check this block if the article is insured.

Block 3: If insured, enter the value for which the article is insured.

Block 4: Enter the registered, insured, recorded delivery, or Express Mail number that was assigned to the article.

Block 5: Enter the name of your command and FPO number.

Block 6: Enter the date you accepted the article for mailing.

Block 7: Enter the name and complete address of the addressee as it appears on the article.

The remainder of the reverse side is completed by the post office of delivery.

### Endorsements

Attach the return receipt to the article. If the article is a letter, attach the return receipt to the back of the letter. Place an impression of the APDS partially on the return receipt and partially on the letter. Endorse the article on the address side AVIS DE RECEPTION or the capital letter A.

NOTE: Include the weight of the return receipt in determining the postage and fees for mailing the article.

### RESTRICTED DELIVERY

Restricted delivery is a service that may be purchased by a mailer to restrict its delivery to the addressee. Some countries may permit delivery to agents of the addressee and/or require only the signature of a postal official on the return receipt.

Restricted delivery is available only:

At the time of mailing

For registered items or recorded delivery

If accompanied by a return receipt

To certain countries (refer to the Individual Country Listings of the IMM)

When the sender requests restricted delivery service, ensure that the item is endorsed A REMETTRE EN MAIN PROPRE or the equivalent in a language known in the destination country. The endorsement should be located on the address side below the return address.

### RECALL/CHANGE OF ADDRESS

On request by the sender, an item can be recalled (withdrawn from the mail and returned to sender) or its address can be changed subject to conditions and limitations listed in the IMM. These services can be requested at:

the office of mailing,

the U.S. dispatching exchange office, or

the country of end destination.

Some countries DO NOT provide these services. Refer to Section 360 of the IMM for current instructions and for a list of countries that do not provide these services.

### SPECIAL DELIVERY

Special delivery service is available to most countries for all types of postal union mail. Refer to the Special Services section, Individual Country Listings of the IMM, for exceptions. Special delivery service is NOT available for parcel post.

When the mailer requests special delivery of a postal union article, take the following actions:

Give the mailer a PS Label 57, EXPRES-Special Delivery (see figure 6-12).

Have the mailer place PS Label 57 above the address and below the postage. If PS Label 57 is not available, ask the mailer to mark the article EXPRES-Special Delivery in red.

### SPECIAL HANDLING

Special handling is available only for the following articles when paid at the surface rate of postage:

Parcel post packages

Printed matter

Matter for the blind

Small packets

Articles sent as special handling receive preferential handling to the extent practical in dispatch and transportation from the post office of mailing to the U.S. office of dispatch. Special handling does not offer preferential treatment in the country of destination.

Have the mailer endorse the article SPECIAL HANDLING above the name of the addressee and below the stamps, or apply the endorsement with a rubber hand stamp.

### RECORDED DELIVERY

Recorded Delivery is the international service equivalent to domestic certified mail. This service provides the mailer with a numbered mailing receipt



PCf0612

Figure 6-12.—An example of a PS Label 57.

(PS Form 8099, Receipt for Recorded Delivery) and affords the opportunity to obtain confirmation of delivery through the purchase of a separate return receipt for an additional fee. Like certified mail the originating post office does NOT maintain a mailing record. However, the destination post office is required to retain a record of delivery for each recorded delivery item delivered to an addressee.

Recorded delivery service is NOT available to all countries. Refer to the Individual Country Listings before acceptance.

The sender must complete PS Form 8099 (see figure 6-13) and place it on the address side above the address and to the right of the return address. The accepting clerk must verify that the form has been completed properly and that the correct fee and amount of postage has been affixed, postmark the receipt and return it to the mailer.

Customers can mail recorded delivery items at a post office, or deposit them in street letter drop boxes if a post office receipt is not desired.

### SUPPLEMENTARY SERVICES (REPLY COUPONS)

Every country requires that its own stamps be used on outgoing mail. International reply coupons offer individuals a means of obtaining postage from post offices in foreign countries. Member countries of the Universal Postal Union purchase international reply coupons and sell them at their respective post offices.

Although coupons sold in the United States have the selling price printed on them, coupons of other countries may not. One of these coupons is exchangeable in any other member country for a stamp or stamps representing the international postage on a single-rate letter.

Only post offices that have a demand for reply coupons should stock them. Reply coupons are ordered using PS Form 17 in the same manner as ordinary domestic postage stamps. PS Form 17 will be covered later in this training manual.

*Q6-24. Postal insurance is only available for what class of international mail?*

*Q6-25. What PS form is used when an insured receipt is issued to a customer who requests insurance coverage of an international parcel post package?*

*Q6-26. What is the PS form number for an International Return Receipt?*

Now turn to appendix 1 to check your answers.

### INTERNATIONAL MAIL CHECKLIST

**LETTERS (IMM 220):** Letters (current, personal correspondence) weighing 4 lbs. or less. If airmail, refer to Section 145.3 of the IMM. A customs form is not required unless the country specifically requires it.

**LETTER PACKAGES (IMM 220):** Letters and merchandise, or just merchandise weighing 4 lbs. or less. If airmail, refer to Section 145.3 of the IMM. Use

**U.S. Postal Service  
RECORDED DELIVERY RECEIPT  
(International Mail Only; No Insurance Coverage Provided)**

Postage	\$	Postmark Here
Recorded Delivery Fee		
Return Receipt Fee (Endorsement Required)		
Restricted Delivery Fee (Endorsement Required)		
Total Postage & Fees	\$	

Recipient's Name (Please Print Clearly) (To be completed by mailer)

Street, Apt. No., or PO Box No.

City, State, ZIP+ 4, Country

PS Form 8099, February 2000 See Reverse for Instructions

PCf0613

Figure 6-13.—An example of a PS Form 8099.

PS Form 2976 Customs Form. Endorse the article LETTER or LETTRE.

POSTAL/POST CARDS (IMM 230, Section 231.1): If Airmail, refer to Subsection 234.21 of the IMM.

AEROGRAMMES (IMM 230, Section 231.2): Contains specific information on aerogrammes.

REGULAR PRINTED MATTER (IMM 240, Subsection 241.21): Newspapers/Magazines weighing 4 lbs. or less to Canada and Ireland, 11 lbs. or less to all other countries. If over weight or size limit, mail as Parcel Post. If airmail, refer to Section 145.3 of the IMM. Use PS Form 2976 Customs form. Endorse article PRINTED MATTER.

BOOKS and SHEET MUSIC (IMM 240, Subsection 241.22): Books or Sheet Music weighing 4 lbs. or less to Canada and Ireland, 11 lbs. or less to all other countries. If over weight or size limit, mail as Parcel Post. If airmail, refer to Section 145.3 of the IMM. Use PS Form 2976 Customs form. Endorse article(s) PRINTED MATTER-BOOKS or PRINTED MATTER-SHEET MUSIC.

PUBLISHER'S PERIODICALS (IMM 240, Subsection 241.23): Publisher's periodicals mailed as printed matter can weigh up to 30 lbs. to Canada, 4 lbs. to Ireland, and 11 lbs. to all other countries. If over weight or size limit, mail as Parcel Post. If airmail, refer to Section 145.3 of the IMM. Use PS Form 2976 for articles known to be dutiable in the country of destination. Endorse article PRINTED MATTER-PERIODICALS.

SMALL PACKET (IMM 260): Merchandise which, depending upon the country, can weigh up to 1 lb., 2 lbs., or 4 lbs. If over weight or size limit for a particular country, mail as Parcel Post. If airmail, refer to Subsection 264.22 of the IMM. Use PS Form 2976 Customs form. Endorse article SMALL PACKET.

PARCEL POST (IMM 270): The only class of mail that may be INSURED. Use Parcel Post when the article is over the weight or size limit for Small Packet or Printed Matter. Also, Parcel Post may be the cheaper rate when special services cannot be given for Postal Union. If airmail, refer to Section 274.2 of the IMM. Refer to the individual country listing and Section 123 of the IMM for the correct Customs form.

Based on the contents of the article, size and weight limitations, mailing restrictions and special services requested, use the following chart to determine the category of mailing:

LETTER	MERCHANDISE
Letter Ltr Pkg	Letter Package Small Packet Parcel Post
PRINTED MATTER	PRINTED MATTER BOOKS
Printed Matter Parcel Post	Printed Matter Books Parcel Post

### STEPS FOR PROCESSING POSTAL UNION AND PARCEL POST ARTICLES

1. Read Prohibitions, Restrictions, and Observations for mailing.
2. Check article's contents and determine if the class of matter is letter only or with merchandise, merchandise only, regular printed matter, or printed matter books.
3. Check the article's weight and size to determine if it is within the limits for the class of mail you are going to use.
4. Check the special services requested. Some services might not be available to all international countries.

POSTAL UNION MAIL: Length + Width + Height (Thickness) DON'T double the Width or Height.

PARCEL POST MAIL: Length + Girth or Length + Width x 2 + Height x 2 (This is the Girth).

### CHECKLIST FOR SPECIAL SERVICES

The following information is provided for assisting you in understanding the procedures for handling International special services. See table 6-1 (next page).



Table 6-1.—Checklist for Special Services.

TYPE	AVAILABILITY	ENDORSEMENTS	FORMS/LABELS	APDS
INSURANCE (320)	PARCEL POST	INSURED NUMBER AND SDR ENDORSEMENTS	PS FORM 3813-P	ON SEAMS
REGISTERED MAIL (330)	POSTAL UNION (REFER TO INDIVIDUAL COUNTRY LISTINGS)	PS LABEL 200 (REFER TO SUBSECTION 334.13a OF IMM)	PS FORM 3806	ON SEAMS
RETURN RECEIPT (340)	REGISTERED MAIL, RECORDED DELIVERY, AND INSURED MAIL	AVIS DE RECEPTION OR “A”	PS FORM 2865	REFER TO IMM 334.31
RESTRICTED DELIVERY (350)	REGISTERED MAIL OR RECORDED DELIVERY WITH RETURN RECEIPT (REFER TO INDIVIDUAL COUNTRY LISTINGS)	A REMETTRE EN MAIN PROPRE OR EQUIVALENT IN COUNTRY OF ADDRESS	NONE	NONE
SPECIAL DELIVERY (370)	POSTAL UNION MAIL ( REFER TO INDIVIDUAL COUNTRY LISTINGS)	EXPRESS-SPECIAL DELIVERY OR PS LABEL 57	PS LABEL 57	NONE
SPECIAL HANDLING (380)	SURFACE PARCEL POST, PRINTED MATTER, MATTER FOR THE BLIND, AND SMALL PACKETS	SPECIAL HANDLING	NONE	NONE
RECORDED DELIVERY (385)	REFER TO SECTION 385.2 OF THE IMM	A REMETTRE EN MAIN PROPRE OR EQUIVALENT IN COUNTRY OF ADDRESS	PS FORM 8099	NONE



## CHAPTER 7

# REGISTERED MAIL

This chapter discusses all aspects of processing registered mail within the Military Postal Service. You will learn about the procedures to control the acceptance, dispatch, transfer of custody requirements, and delivery of registered mail, both incoming and outgoing.

### REGISTERED MAIL SYSTEM

---

**Learning Objective:** *Recall the accepting and receipting procedures for registered mail.*

---

As stated in the DMM, registered mail is the most secure service that the USPS offers. It incorporates a system of receipts to monitor the movement of mail from the point of acceptance to delivery. Registered mail service provides the sender with a mailing receipt, and a delivery record is kept at the post office of address.

Because registered articles may contain money, valuable articles, or classified material (Confidential and Secret), it is important that registered mail always be given proper security.

### WHAT MAY BE REGISTERED

Only matter prepaid with postage at the First-Class or Priority Mail rate may be registered. Stamps or a postage meter tape must be affixed to registered articles to cover the amount of postage and fees. Business reply mail may not be registered. Registration may only be obtained by presenting the article at the post office. Mail will NOT be registered if:

- placed in collection boxes or in mail drops in post offices
- addressed to post offices to which it cannot be safely transported
- improperly prepared
- consisting of two or more articles that are tied or fastened together, unless the articles are enclosed in the same envelope or wrapper

### POSTAL INSURANCE

Postal insurance coverage may be purchased for personal mail that is registered in the event of loss or damage. The mailer must inform the accepting clerk of the full value of an article presented for registration. The value of an article determines the fee charged for registry service. Private insurance carried on an article does not modify the requirement for declaring the article's full value.

The value of official mail must also be declared when presented for mailing so that it may be given proper handling.

If the mailer desires payment in the event an article is lost or damaged, postal insurance in amounts of up to \$25,000 can be purchased at the time of mailing. Values of various items should be declared as shown in figure 7-1.

### NEGOTIABLE AND NONNEGOTIABLE INSTRUMENTS

To understand how the value of negotiable and nonnegotiable articles are determined, you must know the meaning of the two terms. A negotiable item is any instrument that can be exchanged for cash or goods without the signature of the bearer. An example of a negotiable instrument is a gift certificate. All one has to do to receive the merchandise is to turn in the certificate.

Nonnegotiable instruments are items that require a bearer's signature to be exchanged for cash or merchandise. Would an income tax check be considered a negotiable item? No. A tax return check requires a signature to cash it; therefore, it is nonnegotiable.

### PREPARATION BY SENDER

Postal employees are not permitted to assist in the preparation or sealing of mail to be registered. The mail must bear the complete names and addresses of both the mailer and addressee. Envelopes or packages that appear to have been opened and resealed, or that are otherwise improperly prepared, must not be registered. Padded envelopes may NOT be used for

<u>KIND OF MAIL MATTER</u>	<u>VALUE TO BE DECLARED</u>
Negotiable Instruments- Instruments payable to bearer, including stock certificates endorsed in blank.	Market value. (All values are based on the value at the time of mailing.)
Nonnegotiable Instruments- All registered bonds, warehouse receipts, checks, drafts, deeds, wills, abstracts, and similar documents. Certificates of stock are considered nonnegotiable so far as declaration of value is concerned unless they are endorsed in blank.	No value, or replacement cost if postal insurance coverage is desired. (See note below)
Money	Full Value
Jewelry, Gems, Precious metals.	Market value or cost
Merchandise	Market value or cost
Nonvaluables-matter not having intrinsic value such as letters, files, records, etc.	No value, or replacement cost if postal insurance coverage is desired. (SEE NOTE BELOW)
Note: Mailers who do not know replacement costs should contact a person or firm familiar with such documents and determine replacement costs before the articles are mailed.	

**Figure 7-1.—A guide for declaring the value of articles to be registered.**

domestic registered mail, but they may be used for international registered mail.

### Sealing

All sides of a parcel must be completely sealed (see figure 7-2). One of the main purposes for registering

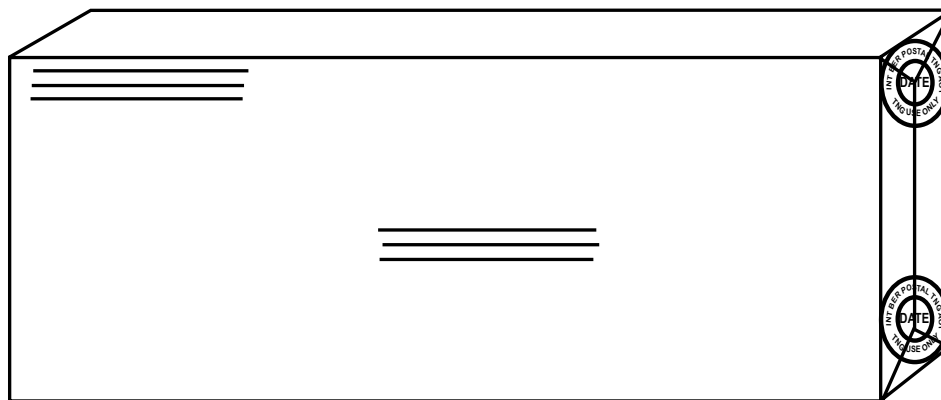

PC0702

**Figure 7-2.—A parcel showing placement of the APDS for sealing.**

mail is to provide security against unauthorized openings. Where flaps are not completely sealed, tape must be used to ensure that no free edge is exposed. Such tape must be of a type that can absorb an ink impression, such as paper tape or cloth tape. Clear tape (Scotch tape) and masking tape ARE NOT ACCEPTABLE.

The mailer must securely seal envelopes. Self-sealing envelopes are not acceptable as registered mail unless sealed with paper tape (see figure 7-3). Envelopes of strong construction may be accepted for mailing as long as they are completely sealed. Envelopes sold by the USPS are ideally suited for registration. If tape is used to seal the flaps of letter-size envelopes, the tape must not be placed over the intersections of the flaps. A space on each side of the intersecting flaps must be left open for postmarks.

### Packaging

All articles presented for registration must be packaged following the procedures in chapter 3 of this training manual and Module C of the DMM. As the accepting clerk, you may refuse to accept an article if you determine that it is not packaged in a manner that will assure safe transmission in the mails. The mailer must also tell you whether or not the item is fragile. When it is of a fragile nature, the mailer must describe the interior packaging.

### WINDOW ENVELOPES

Window envelopes that do not have a panel over the opening cannot be used for registered mail. If a transparent panel is glued to the envelope, the envelope may only contain matter of no intrinsic value. The

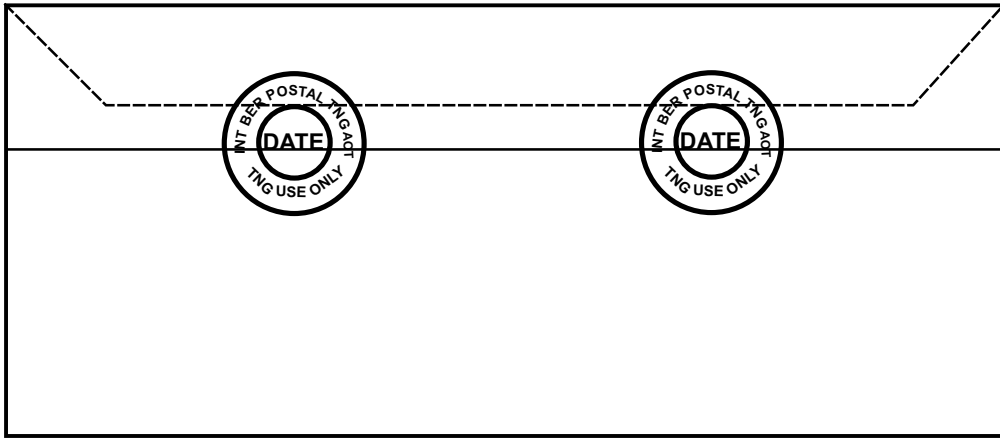

PCf0703

**Figure 7-3.—A self-sealing envelope sealed with paper tape.**

envelope may be used for all registered mail if the panel is a part of the envelope. Figure 7-4 shows a window envelope that is acceptable for registration.

### REGISTRATION NUMBERS

Once an article is accepted at a military or civilian post office, it becomes an accountable item. That is, some person is always accountable for that item as long as it is in the postal system. To account for registered mail a number is assigned to each piece. All registered mail must be numbered with a preprinted, self-adhesive label. The registered mail labels are designated as PS Label 200. This label can be ordered from the USPS material distribution center at Topeka, KS. The labels are about 1 1/2 inches high by 3 1/4 inches long. The number series begins with the letters RR, followed by nine number digits then ends with US. The letter and number digits are in an OCR readable print (see figure 7-5).



PCf0705

**Figure 7-5.—An example of a USPS Label 200.**

### COMPUTING POSTAGE AND FEES

Compute the postage, fees, and other charges as soon as you have determined that the article is acceptable for mailing and after the mailer has declared the value. Weigh the article first to determine the First-Class or Priority Mail rate of postage before computing the fees. Then refer to Module R of the DMM, and compute the registry fee according to the declared value.

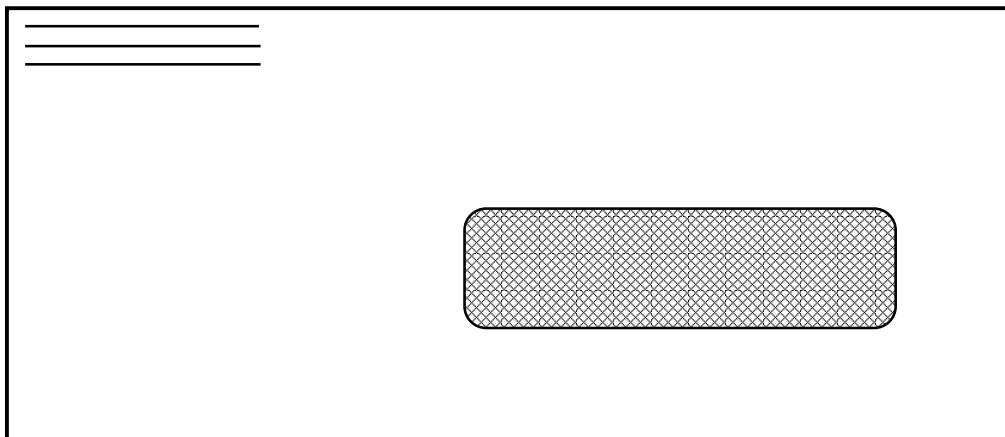

PCf0704

**Figure 7-4.—A sample of a window envelope.**

Registered mail service may be combined with certain other services such as a return receipt or restricted delivery. To figure the total, you should compute the charges in the order shown on the registry receipt (PS Form 3806).

The total postage and fees are paid in postage stamps and affixed in the upper-right corner by the customer unless a postage meter tape is used.

**REGISTERED MAIL RECEIPT**

An article is not considered as registered mail until a receipt has been issued. A receipt must be issued when you have accepted the article for registration. The receipt is prepared by you and the mailer. PS Form 3806, Receipt for Registered Mail (see figure 7-6), is used for this purpose. This form is issued in a set of two copies. The form is printed on special paper that makes a copy without the use of a carbon sheet.

PS Form 3806 is completed as follows:

Block 1: Customer enters the full dollar value of the article. If the article has “no value,” write NONE or NCV (No Commercial Value). DO NOT write zero “0” in this block.

Block 2: Customer checks one of the boxes, either “With Postal Insurance” or “Without Postal Insurance.” The mailer has the option to purchase postal insurance

to cover articles valued up to \$25,000 at the time of mailing. Leave these blocks blank for international mail.

Block 3: Customer enters the “From” address, just as it appears on the article being presented for mailing. The return address must include a full name, complete street address, city, state, and ZIP Code, or military address and APO/FPO number.

Block 4: Customer enters the “To” address, just as it appears on the article being presented. The addressee’s address must include a full name, complete street address, city, state, and ZIP Code, or military address and APO/FPO number.

Block 5: Accepting clerk enters the registered number including the “RR” and “US.” The registered number is obtained from the preprinted number on PS Label 200.

Block 6: Accepting clerk enters the amounts for the postage, registry fee, and fees for any additional special services requested.

Block 7: Accepting clerk signs his/her name.

Block 8: Accepting clerk applies an impression of the APDS to the customer and post office copy of the PS Form 3806.

<b>Registered Mail</b> ⑤		<b>Date Stamp</b>	
To Be Completed By Post Office	Reg. Fee \$	Special Delivery \$	⑧  Domestic Insurance is Limited To \$25,000; International Indemnity is Limited (See Reverse)
	Handling Charge \$	Return Receipt \$	
	Postage \$	Restricted Delivery \$	
	Received by ⑦		
To Be Completed By Customer (Please Print) All Entries Must Be in Ballpoint or Typed	Customer Must Declare Full Value \$ ①	② <input type="checkbox"/> With Postal Insurance <input type="checkbox"/> Without Postal Insurance	
	FROM	③	
	TO	④	
PS Form 3806, <b>Receipt for Registered Mail</b> February 1995		(Customer Copy) (See information on Reverse)	

Figure 7-6.—An example of a PS Form 3806 (Receipt for Registered Mail).

## CANCELING STAMPS AND APPLYING ENDORSEMENT

After you have completed the receipt, collect the required amount for the postage and fee(s). If ordinary stamps are used, have the customer place the stamps in the upper-right corner of the article. Give the customer the original of the PS Form 3806 and keep the duplicate for your post office files. Apply the PS Label 200 to the address side between the return address and the postage for domestic mail and in the lower-left corner of the address side for international mail. Cancel the stamps using the APDS.

## POSTMARKING

One of the most important reasons for registering mail is to provide security against unauthorized opening of letters or parcels. This is why you must stamp postmarks with the APDS on each sealed side of a registered article in such a way that an unauthorized opening would disturb the postmarks, thereby providing evidence that it has occurred. Postmarks are placed on letters TWICE on the back at the crossing of the upper and lower flaps. When a return receipt is attached to the back, postmark partially on the receipt and partially on the flaps of the letter. Postmark parcels in all places where the tape or flaps intersect. When parcels are sealed with paper tape, postmark across opposite sides of the strips. Use additional postmarks if this would make rifling more difficult.

## REFUNDS AND RECALLS

The mailer may withdraw or recall registered mail without charge before its delivery under the following conditions:

- By writing on the receipt, “Withdrawn Before Dispatch,” and signing and surrendering the receipt.
- By filing a written request for its return after dispatch at the post office where the article was mailed, giving names and addresses of mailer and addressee, the registry number, and date of mailing. The mailer must pay for faxes sent or long-distance telephone calls made to locate the article.

If remailed, the article must be under a new cover and bear new postage and fees.

Registration fees should not be refunded after the mail is accepted. Return receipt or restricted delivery

fees should be refunded only when failure to furnish a return receipt or to give restricted delivery was the fault of the USPS. Receipts for fees must be submitted with requests for refunds.

- Q7-1. What are three valid reasons for refusing to register an article for a customer?*
- Q7-2. What factor determines the registration fee charged for a piece of registered mail?*
- Q7-3. What is the maximum amount of indemnity that may be claimed for registered mail?*
- Q7-4. Define negotiable and nonnegotiable instruments.*
- Q7-5. As a military postal clerk, you are expected to assist the postal customer in the preparation or sealing of mail to be registered. (True/False) Explain.*
- Q7-6. One of the most important reasons for registering mail is to provide security against unauthorized opening of letters or parcels. (True/False)*
- Q7-7. Name two types of tapes that are not acceptable for the sealing of items presented as registered mail.*
- Q7-8. During what stage of the registration process is the article considered to be registered?*
- Q7-9. What method is used to mark registered items that provides evidence of unauthorized opening?*
- Q7-10. At least how many times and in what locations are postmarks placed on the back of letters?*

Now turn to appendix 1 to check your answers.

## REGISTERED MAIL PROCESSING

---

**Learning Objective:** Recall the definitions and handling guidelines for classified material authorized to be sent as official registered mail.

---

Now that we have discussed the criteria for accepting registered mail, let’s look at the processing and handling aspects starting with classified material sent by command official mail.

When classified material is sent through the registry system, it must be mailed in strict accordance with the Department of the Navy (DON) Information Security Program (ISP) Regulation, SECNAVINST 5510.36. Let's discuss the two classifications authorized to be transported by registered mail.

## SECRET

SECRET is the classification level applied to information whose unauthorized disclosure could reasonably be expected to cause serious damage to the national security. Examples include information whose unauthorized release could result in disruption of foreign relations significantly affecting the national security; the disclosure of significant military plans or intelligence operations; and the disclosure of scientific or technological developments relating to national security.

The following information lists the security requirements for mailing material classified SECRET:

- USPS registered mail within and between the U.S. and its territories.
- USPS registered mail through Army, Navy, Marine Corps, or Air Force postal service facilities, outside the area of the U.S. and its territories, provided that the material does not at any time pass out of U.S. citizen control and does not pass through a foreign postal system.
- USPS and Canadian registered mail with registered mail return receipt between U.S. Government and Canadian government installations in the U. S. and Canada.

## CONFIDENTIAL

CONFIDENTIAL is the classification level applied to information whose unauthorized disclosure could reasonably be expected to cause damage to the national security. Examples include information whose unauthorized release could result in disclosure of ground, air, and naval forces (e.g., force levels and force dispositions); or disclosure of performance characteristics, such as design, test, and production data of U.S. munitions and weapons systems.

The following information lists the security requirements for mailing material classified CONFIDENTIAL:

- USPS First-Class Mail between DoD activities anywhere in the U. S. and its territories. The

outer wrapper or envelope shall be endorsed "Return Service Requested."

- USPS certified mail for information addressed to a cleared DoD contractor facility or non-DoD agency.
- USPS registered mail to and from FPO and APO addresses located outside the U.S. and its territories, and when the originator is uncertain that the addressee's location is within U.S. boundaries.

## PURPOSE

---

**Learning Objective:** *Recall the security provided for registered mail and the receipts that are used in the registered mail system.*

---

From the time a piece of registered mail is accepted until it is delivered to the addressee, someone is always personally responsible for its safety. The fact that classified information up to and including SECRET is authorized to be sent by official registered mail is evidence of the confidence placed in registered mail. Military postal personnel should always assume that official registered mail contains classified material.

To provide the security required for classified material, official and personal registered mail must be dispatched only on scheduled U.S. commercial, passenger nonstop flights; all-cargo aircraft; AMC aircraft; or surface transportation as directed. Between overseas locations registered mail may also be dispatched on Navy military aircraft.

The JMPAs, in coordination with overseas commanders, designate which flights will carry registered mail. The designated flights are those that arrive at the most convenient time for the receiving locations, as they must be met by assigned U.S. military personnel. Some ports overseas have no military postal facilities nearby. When in these ports, and there is no U.S. commercial, passenger nonstop flights; or all-cargo aircraft, then registered mail will be dispatched to your port of call on AMC aircraft. You may also receive registered mail on Navy aircraft scheduled in advance to provide logistics support to your port of call. You will be given sufficient advance notice of incoming AMC or Navy military aircraft. This will allow you to meet the plane and accept delivery of mail for your ship and any other ships



scheduled for the same port visit for which you have been tasked with mail receipt and dispatch responsibilities. You should be at the airport at least 1 hour before the scheduled arrival or departure time for unforeseen schedule changes.

## RECEIPT SYSTEM

Registered mail service provides a receipt to the mailer at the time of mailing. Each registered article is assigned a number for identification purposes. This number is placed on the article and the receipt at the time of mailing. A continuous chain of receipts is maintained thereafter by each person that handles the article. The person who last signs the receipt is responsible until a receipt in turn is obtained. Responsibility thus passes from one person to the next until the article is ultimately delivered to the addressee who also signs a receipt.

Registered mail is transported, receipted for, or processed for delivery by using the following forms:

- PS Form 3806, Receipt for Registered Mail
- PS Form 3849, Delivery Notice/Reminder/Receipt
- Form 3854, Manifold Registry Dispatch Book
- PS Form 3877, Firm Mailing Book for Accountable Mail
- PS Form 3830-A, Registry Dispatch Record
- PS Form 3883, Firm Delivery Receipt for Accountable Mail and Bulk Delivery Mail
- OPNAV Form 5110/9, Mail Manifest
- DD Form 1384, Transportation Control and Movement Document

You became familiar with the processing and receipting of registered mail using PS Form 3806 earlier in this chapter. When the mailer is given the original copy of PS Form 3806, the article is then considered accepted as registered mail.

When preparing articles for registration, volume mailers, such as staffs or units embarked aboard ship, must use PS Form 3877 (see figure 7-7). The office responsible for preparing outgoing official registered mail completes this form. Information required to be entered on the form:

Block 1: Name and address of mailer

Block 2: Registered mail is checked to indicate type of accountable mail being mailed

Block 3: List of articles by registry number

Block 4: List of name and address of each addressee for each article mailed

Block 5: A single diagonal line is drawn to prevent further entries below last entry

Block 6: The total number of registered articles listed

Block 7: The amount for postage and registration fee is entered in appropriate area

Before acceptance, the accepting clerk checks each article number against the entries on the form for proper completion and ensures all addresses are correct. The accepting clerk then enters, in Block 8, the total number of articles received, and signs as the accepting clerk in block 9.

When PS Form 3877 has been completed and all information is correct, the accepting clerk places the APDS on the original and duplicate copy, keeps the original copy, and gives the duplicate to the mailer.

In the event there are errors noted on the form, the following procedures apply:

- Do not change the registration number on the form. Draw a line through the incorrect entry, initial it, and make the correct entry.
- If there is an error in the numbers listed and received after acceptance, and the mailer has departed the post office, the error should be corrected and a notation made explaining this action.

PS Form 3806 and PS Form 3877 are the most common methods used by MPOs to accept registered mail.

The accepting office is always considered the office of origin, regardless of the return address listed on the article.

*Q7-11. When official registered mail is in the control of military postal clerks, it must be provided the same security given to classified material of what level?*

*Q7-12. What is the purpose of the registered mail system?*

*Q7-13. Official registered mail may only be transported from overseas activities on what types of air carriers?*

*Q7-14. Large volume mailers normally will account for and mail registered articles using what PS form?*

Name and Address of Sender		Check type of mail:		If Registered Mail, check below:		Affix stamp here if issued as certificate of mailing, or for additional copies of this bill.						Postmark and Date of Receipt	Remarks		
①		②		③		④						⑤			
Line	Article Number	Addressee Name, Street, and PO Address	Postage	Fee	Handling Charge	Actual Value (If Reg.)	Insured Value	Due Sender If COD	RR Fee	DC Fee	SC Fee	SH Fee	SD Fee	RD Fee	Remarks
1	③	④	⑦												
2															
3															
4															
5															
6															
7															
8															
9															
10															
11															
12															
13															
14															
15															

Total Number of Pieces Listed by Sender: ⑥  
 Total Number of Pieces Received at Post Office: ⑧  
 Postmaster, Per (Name of receiving employee): ⑨

The full declaration of value is required on all domestic and international registered mail. The maximum indemnity payable for the reconstruction of nonnegotiable documents under Express Mail document reconstruction insurance is \$50,000 per piece subject to a limit of \$500,000 per occurrence. The maximum indemnity payable on Express Mail merchandise insurance is \$500. The maximum indemnity payable is \$25,000 for registered mail, sent with optional postal insurance. See Domestic Mail Manual R900, S913, and S921 for limitations of coverage on insured and COD mail. See International Mail Manual for limitations of coverage on international mail. Special handling charges apply only to Standard Mail (A) and Standard Mail (B) parcels.

PS Form 3877, April 1999 Complete by Typewriter, Ink, or Ball Point Pen

PCf0707

Figure 7-7.—An example of a PS Form 3877.

Q7-15. The post office facility accepting a registered mail article is considered as the office of origin. (True/False)

Now turn to appendix I to check your answers.

### PROCESSING REGISTERED MAIL FOR DISPATCH

**Learning Objective:** Identify the procedures for preparing registered mail for dispatch.

The first step in the processing of outgoing registered mail is separating the pieces by destination. While you are separating the pieces by destination, a quick double check should be made to make sure each piece is correctly endorsed and properly postmarked. After you have completed separating all of your registered mail by destination, and have checked for proper endorsements and postmarks, you are ready to start your dispatch procedures. Personal and official registered mail are dispatched in the same pouch, there

is no need to prepare separate pouches. Registered mail addressed to APO and FPO addresses should be pouched separately and sent to the nearest FMC or Navy post office.

### MAIL POUCHES AND SACKS

Registered mail must never be dispatched in torn or defective mailbag equipment. Mail pouches and sacks used for dispatch of registered mail should be examined to ensure that such equipment is not torn or otherwise defective. Any hole renders the equipment unusable for registered mail. The selection of proper mailbag equipment for the transport of registered mail cannot be overemphasized.

### NUMBERED SEAL POUCHES

Now that you have completed examining the pouch for defects, the next procedure in the registry dispatch process is to enclose all registered mail into the pouches. You should enclose all parcels into pouches, if possible, to prevent handling as ordinary mail.

PS Form 3854, prepared in duplicate, is used as an inside bill to document registered mail, which is being

enclosed in a pouch (see figure 7-8). Complete this form using a ball point pen as follows:

**Block 1:** Enter the next bill number (on the bill and coupon). The forms should be numbered in sequence, starting with number 1 at the beginning of the calendar year. If more than one page is required to make up the dispatch, show the same bill number on each page.

**Block 2:** Enter the page number. Place an "X" after the last page number. If you use only one page (30 items or less), then write 1X. If you use two pages (more than 30 items), then write 1 on the first page and 2X on the second page. Keep in mind that no more than 200 pieces can be placed in any one registered mail pouch.

**Block 3:** Enter the number of the seal (on the bill and coupon) that will be used to secure the pouch.

**Block 4:** Enter the final destination where the mail is to be dispatched. Although the pouch may be processed by other facilities for further dispatch, the final destination is the facility that opens the pouch.

**Block 5:** Postmark with the APDS on the bill and coupon.

**Block 6:** List the registry numbers (preferably in numerical sequence) of the articles enclosed and the office of origin for each article. If an error is made during the preparation of the bill, draw a single line through the incorrect entry and initial it. Make the correct entry on the following line.

**Block 7:** Close the bill by drawing a diagonal line through the unused portions of the bill.

**Block 8:** Enter the total number of registered articles listed on the bill.

**Block 9:** Enter the annotation WITNESS or WIT followed by the witness's signature.

**Block 10:** Registry clerk signs name.

**Block 11:** Enter the current time.

Now that all the articles that will be dispatched in a numbered sealed pouch are listed on the inside bill and

Lock No. ....	Rotary No. ....	Jacket No. ....	Control No. ....	<b>REGISTERS</b>	Postmark of ⑤ Dispatching Office	
Bill No. .... ①	Page No. .... ②	Airmail .....	Seal No. .... ③		Postmark of ⑤ Dispatching Office	
To ..... ④ (P.O. or R.P.O. and Tr. No.)						
Reg. No., Jacket, Lock or Seal Nos.	Office or ZIP of Origin. Use only for Jacket, Lock, or Seal Numbers. Not required for individual Reg. Nos.	Reg. No., Jacket, Lock or Seal Nos.	Office or ZIP of Origin. Use only for Jacket, Lock, or Seal Numbers. Not required for individual Reg. Nos.			
1. .... ⑥		16. ....				
2. ....		17. ....				
3. ....		18. ....				
4. ....		19. ....				
5. ....		20. ....				
6. ....	⑦	21. ....				
7. ....		22. ....				
8. ....		23. ....				
9. ....		24. ....				
10. ....		25. ....				
11. ....		26. ....				
12. ....		27. ....				
13. ....		28. ....				
14. ....		29. ....				
15. ....		30. ....				
A total of .... ⑧ articles sent by this dispatch		POSTMASTER, .... ⑨ ..... ⑩ ..... M. ⑪ Dispatching Clerk.		Postmark of		
A total of .... articles received in this dispatch		POSTMASTER, ..... M. ..... Receiving Clerk.		Receiving Office	Postmark of Receiving Office	
PS Form 3854, April 1985						

Bill No. .... ①

A.M. Rte. & Fil. No. ....

Jacket No. ....

Lock No. ....

Rotary No. ....

Seal No. .... ③

Received articles described on above-specified bill from dispatching office named in postmark.

Receiving Clerks

(Use back for reporting irregularities or discrepancies.)

Figure 7-8.—An example of a PS Form 3854.

the bill properly completed, you are ready to place the articles in the pouch. Pouching is accomplished by:

- Tying the registered articles in bundles as listed on PS Form 3854.
- Placing the original inside manifold dispatch bill under the top piece of the bundle. If there is more than one bundle, place the separate manifold dispatch bills under the top piece of each bundle. Each bundle should remain in the sequential order you used on the manifold bill. If articles cannot be tied into a bundle, put the original bill in an EP-9 (Registry Jacket Envelope) and place it inside the pouch with the articles. See figure 7-9. Retain the duplicate inside bill in the MPO files.
- Closing and securing the pouch in the presence of the witness using a numbered tin band seal (USPS Item No. 817-C). See figure 7-10.



PCf0709

Figure 7-9.—An example of an EP-9, Registry Jacket Envelope.



PCf0710

Figure 7-10.—An example of a numbered tin band seal used to seal registered pouches.

### Method of Sealing

Place the numbered seal on the pouch (see figure 7-11) in the following manner:

### Preparing the Slide Label

Pouches should be labeled (see figure 7-12) to the off-load destination, unless sufficient volume of registered mail is available to make up a direct pouch. The first line of the label should indicate the destination. The second line should show the

endorsement REGISTERED and the weight listed in kilograms. The third line should show the office of origin, which is the MPO preparing the pouch for dispatch. For ships, this is the ship's name and hull number; i.e., USS THE SULLIVANS (DDG-68). For shore installations, this is the dispatching command's FPO number; i.e., FPO AP 96522. The slide label should be dated on the reverse side with the APDS and initialed by the registry clerk closing the pouch.

### REGISTERED OUTSIDE PIECES

Normally, registered articles dispatched from a military post office are enclosed in a pouch and secured with a numbered seal, except when impossible because of size or shape. If an article cannot be enclosed in a pouch, treat it as an outside piece.

### DISPATCHING MAIL DIRECTLY TO U.S. COMMERCIAL AND MILITARY AIR CARRIERS

You are now ready to affix the proper airport-coded tags and/or labels to each individual registered pouch or outside piece. These tags and labels provide information to the air carrier on the method for handling and routing the pouch or outside piece from the time of acceptance to arrival at the airport of final destination. You must exercise caution in the selection and preparation of these tags and labels to prevent misrouting by the air carrier. PS Tag 135-E (see figure 7-13) should be affixed to each pouch, and PS Label 136-E (see figure 7-14) should be affixed to each outside piece. When affixing PS Label 136-E, be sure not to conceal any portion of the registry number. The tags/labels should be serially numbered to identify the total number of articles dispatched to the off-load destination (for example: 1 of 6, 2 of 6, and so forth). Specific guidelines for the use and completion of airport-coded tags and labels for registered mail are found in the USPS Handbook T-7 and should be followed.

The dispatching activity should also record the seal number of each pouch and the registered number of each outside piece on PS Form 3854. This is called an outside bill (see figure 7-15). The outside bill should be completed in triplicate, showing office of origin, as well as office of destination. In addition, the letter "O" should precede the registered number of each outside piece. The letter "S" should precede the number of each numbered seal pouch. When available, the five-digit ZIP Code should be used instead of the

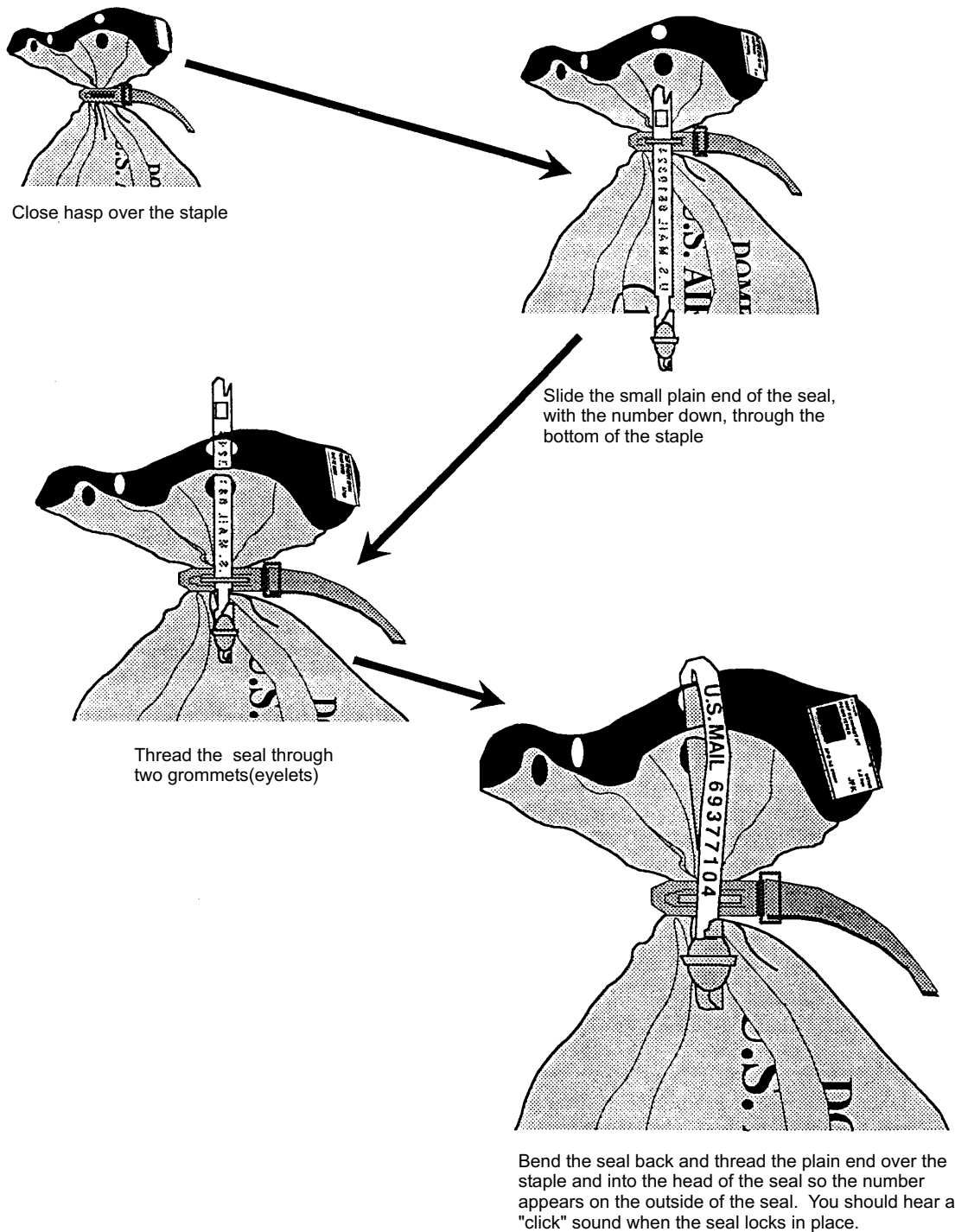

PCF0711

**Figure 7-11.—An example of proper closure and securing of a registered pouch.**

post office of origin. There is, however, one exception, the office of origin for all Navy mobile units must show both the ship's name and ZIP Code.

Enclose the original and third copy of the completed PS Form 3854, together with a pre-addressed return envelope, in a USPS EP-9 registry jacket envelope (see figure 7-9). Securely attach the EP-9 envelope to the outside of the last registry pouch.

If there are no pouches in the dispatch, use an EP-11 outside mail registry bill envelope (see figure 7-16) and attach the envelope to the last piece in the dispatch.

The duplicate copy of the PS Form 3854 should be held by the dispatching activity as a suspense copy until the original is returned by the receiving activity. Upon receipt of the original signed PS Form 3854 from the receiving activity, the dispatching activity should

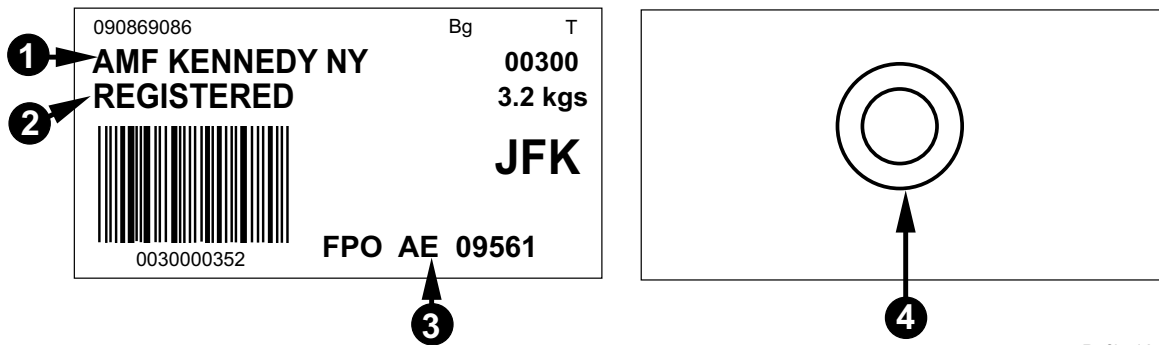
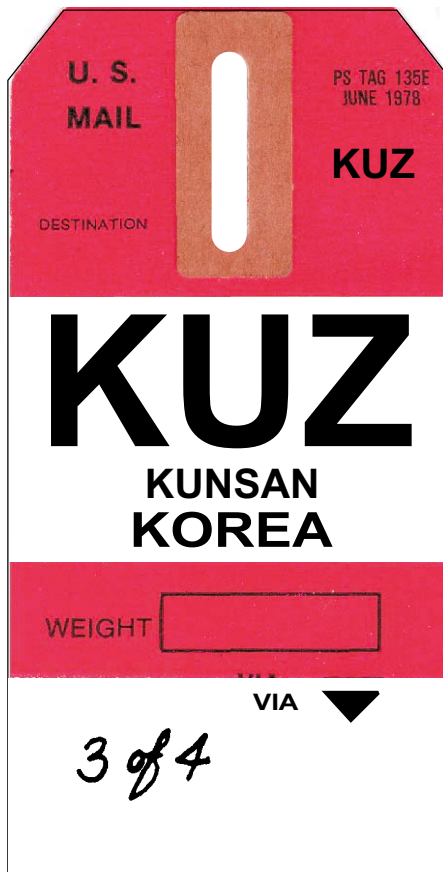

Figure 7-12.—An example of a registered pouch slide label.

Pcf0712



PCf0713

Figure 7-13.—An example of a PS Tag 135-E, airport coded tag for registered mail.

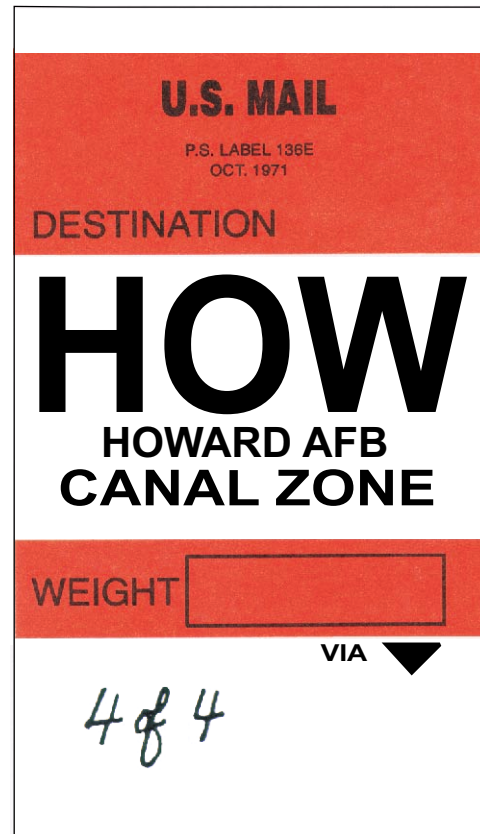

PCf0714

Figure 7-14.—An example of a PS Label 136-E, airport coded label for registered outside mail.

file the original copy with the registry balance sheet that was prepared the day of dispatch. The suspense copy is then destroyed.

### DISPATCHING MAIL DIRECTLY TO MILITARY POST OFFICES

When registered mail is dispatched directly to another military postal activity, PS Form 3854 should be prepared, in triplicate, to account for each pouch and outside piece. In addition, the following procedures apply:

- The registered number of outside pieces should be preceded by the letter “O” and the number of numbered seal pouches by the letter “S.”
- The office of origin of each registered piece must be shown.
- The Postal Clerk entrusted with delivery must sign as receiving postmaster on the triplicate bill. The total number of pieces received must be shown in the appropriate space to the left of the signature.

Lock No. _____	Rotary No. _____	Jacket No. _____	Control No. _____	<b>REGISTERS</b>	Postmark of  Dispatching Office			
Bill No. 88	Page No. 1X	Airmail _____	Seal No. _____		Postmark of  Dispatching Office			
To DIS NORFOLK VA 23511								
(P.O. or R.P.O. and Tr. No.)								
Reg. No., Jacket, Lock or Seal Nos.	Office or ZIP of Origin. Use only for Jacket, Lock, or Seal Numbers. Not required for individual Reg. Nos.	Reg. No., Jacket, Lock or Seal Nos.	Office or ZIP of Origin. Use only for Jacket, Lock, or Seal Numbers. Not required for individual Reg. Nos.					
1. S/6819324	FPO AE 09645	16	/					
2. S/6819325	↓ ↓	17						
3. S/7268520	FPO AE 09644	18						
4. O/RR 001-411-000US	↓ ↓	19						
5. O/RR 001-411-000US	↓ ↓	20						
6. _____		21						
7. _____		22						
8. _____		23						
9. _____		24						
10. _____		25						
11. _____		26						
12. _____		27						
13. _____		28						
14. _____		29						
15. _____		30						
A total of _____ articles sent by this dispatch	POSTMASTER, WITNESS SIGNATURE DISPATCHING CLERK SIGNATURE	CURRENT TIME _____ M. Dispatching Clerk.				Postmark of  Receiving Office		
A total of _____ articles received in this dispatch	POSTMASTER, _____	_____ M. Receiving Clerk.				Postmark of  Receiving Office		

PS Form 3854, April 1985

Figure 7-15.—An example of a PS Form 3854 used as an outside bill.

- The original and duplicate bill should be given to the responsible Postal Clerk for delivery to the receiving postal activity.
- The triplicate copy should be retained in the MPO files.

The registry clerk of the receiving postal activity postmarks and receipts for the mail by signing the original and duplicate bills. The original bill should be retained by the receiving activity and the duplicate bill should be given as a receipt to the delivery clerk. The delivery clerk should then file the duplicate with the registry balance sheet that was prepared for that day/tour of dispatch. The triplicate copy is destroyed.

- Q7-16. What is the first step in the processing of outgoing registered mail?
- Q7-17. What size hole, if any, would render a pouch unusable for the dispatch of registered mail?
- Q7-18. What PS Form is prepared and enclosed in each registered mail dispatch?
- Q7-19. Normally, registered articles dispatched from a Navy post office are enclosed in a pouch and secured with a numbered seal. (True/False)

Q7-20. PS Tag 135-E should be attached to each outgoing pouch of registered mail and PS Label 136-E should be affixed to each outside piece of registered mail. (True/False)

Q7-21. A registered pouch dispatched on a U.S. commercial cargo air carrier should always have what letter preceding the seal number of a registered sealed pouch on the outside bill of PS Form 3854?

Now turn to appendix 1 to check you answers.

## PROCESSING INCOMING REGISTERED MAIL

**Learning Objective:** Identify the procedures involved for handling and delivering incoming registered mail and processing undeliverable registered mail.

The handling of incoming registered mail requires the same processing and care upon receipt, delivery,



PCF0716

**Figure 7-16.—An example of an EP-11, outside mail registry bill envelope.**

and forwarding, if necessary, as does outgoing registered mail. The individual responsibility that has been stressed for outgoing registered mail in this chapter is also true in the processing of incoming registered mail.

### **RECEIPT OF REGISTERED MAIL**

Immediately upon receipt, the numbered seal of each pouch and the registered number of each outside piece (OSP) should be verified with those listed on the appropriate documentation that accompanies the

registry dispatch (PS Form 3854, PS Form 3830-A, DD Form 1384, or OPNAV Form 5110/9). In the event a registered dispatch is received without documentation from a U.S. commercial air carrier, the receiving activity should immediately prepare a substitute PS Form 3854 with the endorsement DUPLICATE-ORIGINAL NOT RECEIVED. At Navy post offices PS Form 3854 must be completed in duplicate. The original PS Form 3854 serves as the record of receipt. The duplicate copy should be returned to the office of the dispatching activity to complete its records.

Military postal activities receiving “tracer action” on registered mail from a dispatching activity should immediately determine if the registered article was received. If received, the receiving activity should immediately contact the dispatching activity by phone, E-mail, or naval message, sign the duplicate form, and return it to the dispatching activity. If it is determined that registered mail was not received at the intended destination, then follow the procedures that will be discussed in the “Irregularities in Receipt” section later in this chapter.

### **Hand to Hand**

When receipting for registered mail on PS Form 3854 from an individual, all copies of PS Form 3854 should be signed by the registry clerk to acknowledge receipt. The receiving military postal activity must keep the original copy for its records. The duplicate copy should be returned as a receipt to the individual.

### **At-Sea Transfer**

During at-sea transfer of registered mail, the receiving ship must furnish an immediate receipt to the transferring unit. If the circumstances of the transfer are of such urgent nature as to prevent the immediate return of the normal receipt, the receiving ship must acknowledge receipt by message and will forward the paper receipt as soon as possible. According to Replenishment at Sea Instructions (NWP 4-01), registered mail must be transferred in weighted, nonwatertight bags whenever feasible to ensure prompt sinking in case of loss.

### **IRREGULARITIES IN RECEIPT**

When registered mail is receipted for and it is noted that all articles listed on the manifest or inside/outside bills are not received, then specific



reporting action must be followed depending on the source of receipt.

For irregularities found in registered mail received from sources such as at-sea highline transfer and command military aircraft, you must take the following actions:

- If all registered mail listed on the dispatch bill is not received, the dispatching activity should be contacted immediately via phone, E-mail, or naval message to determine if the article was actually dispatched.
- If the article was not sent, write NOT RECEIVED opposite the entry on the outside manifold dispatch bill (PS Form 3854) and on OPNAV Form 5110/9 or other documentation accompanying the dispatch. Mark the PS Form 3854 coupon to show the shortage and return the coupon to the dispatching activity.
- If the article was sent, but not received, then a postal offense investigation must be initiated. In addition, the dispatch bill should be noted NOT RECEIVED opposite the entry of the article not received and the bill coupon completed and returned to the dispatching activity. Retain the pouch, label, and seal until the discrepancy is explained satisfactorily or other instructions are received.
- When articles are received, but not listed on the bill, enter the article number on the bill with a note of explanation, and return the coupon from PS Form 3854 with the details of the discrepancy to the dispatching activity. Notify the dispatching activity by phone, E-mail, or naval message.
- When the outside bill is improperly prepared, make corrections on the bill, and return the coupon explaining the discrepancy to the dispatching activity.
- When registered mail is erroneously received, immediately contact the intended destination by phone, E-mail, or naval message and inform the originating postal activity of the articles involved and the plans for dispatch. The articles are then stamped with the APDS by placing the impression on the reverse side of the slide label for pouches and on the back portion of OSPs to indicate they were missent. You should forward missent articles to the proper destination by the next available dispatch.

## **RECEIPTING FOR DAMAGED REGISTERED MAIL**

Unlike reporting irregularities for registered mail, all damaged registered articles should be receipted and reported for in the same manner, regardless of the source of receipt. However, the reporting procedures are different to the extent as to whether the damaged article is personal or official and if depredation or compromise is suspected. Up to this point you are receipting for the damaged article and initiating required reporting procedures.

### **Depredation Not Suspected**

When matter is found loose in a pouch, and there is only one damaged article in the pouch, then the loose matter may be assumed to relate to the damaged article. Place the loose matter in the container that is opened or damaged and rewrap the article. The bill, wrapper, and coupon should be endorsed RECEIVED IN DAMAGED CONDITION, specifying the registered number of the damaged article. The coupon portion of PS Form 3854 should be returned to the dispatching activity.

The following procedures should be followed when loose matter is found in a pouch without an envelope or container that can be related to the loose matter:

- Note all particulars on the bill and coupon.
- Postmark and sign a statement explaining the circumstances and have the statement witnessed.
- Return the coupon to the dispatching activity.
- If unable to determine the person to whom the matter is intended or the owner, then report the facts to the servicing JMPA, who notifies the accountable postmaster's inspector-in-charge. Hold the item until instructions are received.

### **Depredation Suspected**

If a damaged article is received and depredation is suspected, the postal officer must ensure the following:

- A postal offense investigation is initiated following the instructions provided in the *DOD Postal Manual*, Volume I, and OPNAVINST 5112.6.

- The addressee inventories any contents of the damaged article and attempts to determine if they are intact.
- The extent of the damage to the article is summarized on the inside bill and coupon.
- The coupon is returned to the dispatching activity.
- The damaged article is processed according to the instructions received from the investigating agency.

An initial report to MPSA should be made by naval message within 24 hours of the discovery. The MPSA, if deemed necessary, will assign a case number for reference purposes and all subsequent correspondence on the reported offense(s) must be referenced by the case number assigned by MPSA.

### **Receipting for Damaged Official Mail**

In the event official registered mail is received in damaged condition, you should endorse the inside bill and coupon RECEIVED IN DAMAGED CONDITION and return the coupon to the dispatching activity. If actual or possible compromise of classified information is apparent, then the incident should be reported according to the security procedures outlined by SECNAV Instruction 5510.36, Department of the Navy (DON) Information and Personnel Security Program (ISP) Regulation.

### **REPORTING IRREGULARITIES**

When irregularities in the preparation or acceptance of a registered article are noted, the accepting post office should be advised of this fact by PS Form 3826, Registry Irregularity Report (see figure 7-17). The receiving post office completes this form in addition to completing the coupon of PS Form 3854.

### **PROCESSING UPON RECEIPT**

Always have a witness available when you open registry pouches. You should first check the labels of the pouches to make sure that the mail is addressed to your activity. Next, a careful examination of the pouch should be made to make certain there are no holes or ripped seams through which registered mail could have been removed or lost. All registered pouches should be opened individually by performing the following steps (see figure 7-18):

Step 1: Verifying the seal number of the pouch against the seal number listed on the inside bill. Do NOT

discard the seal until a check of the contents is completed and no discrepancy is noted. The slide label should be retained for 30 days. Recommendation: Attach the slide label to the respective inside/outside bill.

Step 2: Checking the registry numbers listed on the bill against the registry numbers on the articles.

Step 3: Entering on this line the number of articles received on this bill.

Step 4: Writing the notation WITNESS or WIT and have the witness sign on this line. At a one-clerk MPO, where no witness is readily available, a witness should be obtained (usually your alternate PC) before opening registered pouches. If circumstances preclude use of a witness, the commanding officer may authorize the use of NWA for no witness available. If authorized, NWA should be entered on the line below the Postal Clerk's signature.

Step 5: Signing your name on this line.

Step 6: Entering the current time here.

Step 7: Postmarking the bill and the coupon with the APDS.

Step 8: Backstamping all registered mail received (letters and OSPs). Be careful not to overlap or obliterate previous backstamps.

### **BILL DISCREPANCIES**

If the pieces received do not agree with the inside bill, the following procedures apply and must be followed:

- The dispatching office is contacted immediately by phone, E-mail, or naval message.
- The appropriate JMPA is notified if the pouch originated in the U.S.
- For articles received but not listed on the dispatch bill, you should enter the article number on the bill with a note of explanation. In addition, you should immediately contact the dispatching activity by phone, E-mail, or naval message, while also returning the annotated coupon.
- Registered articles that were missent to your office are stamped with the APDS to indicate they were missent. Endorse the manifold bill and coupon to indicate which articles were missent. Return the coupon portion to the



**Registry  
Irregularity  
Report**

**REPORTING OFFICE  
POSTMARK**

1. TO:

**Instructions to Reporting Post Office**

Enter in the address space the name of the post office at fault. Complete description of article and indicate irregularities below. Use Item 23 for describing an irregularity not printed on this form and cite governing instructions. Mail report direct to the postmaster.  
**(Use window envelope.)**

**Instructions to Postmaster of Office at Fault:**

Please instruct employee at fault. If firm mailer is involved, request cooperation to prevent recurrence.

If the article was short paid and the required stamps were affixed at the time of mailing, file this form. If there is reason to believe stamps were not affixed, attach to this form serviceable postage stamps or meter stamp in the amount of the deficiency, cancel them, and file this form.

**DESCRIPTION OF ARTICLE**

2. Name and Address of Sender	3. Registration No.	4. Date of Mailing
5. Name and Address of Addressee	6. Station at Fault (If mailed at station)	

**IRREGULARITIES (Check applicable items)**

✓ PREPARATION	✓ SHORT PAID			
7. Improperly wrapped or enveloped	19. Total amount required on article at time of mailing <span style="float: right;">\$</span>			
8. Improperly sealed (Show details in Item 23)	20. Amount of postage attached when received <span style="float: right;">\$</span>			
9. Sealing device affixed in such manner as to interfere with proper postmarking	21. Short paid (See breakdown) <span style="float: right;">\$</span>			
10. Two or more articles registered as one	<b>22. BREAKDOWN OF SHORT PAYMENT</b>			
11. Return address lacking or incomplete (Indicate which)		ACTUALLY PAID	AMOUNT REQUIRED	SHORT PAID
	Postage	\$	\$	\$
	Registry Fee	\$	\$	\$
✓ ACCEPTANCE	Return Receipt	\$	\$	\$
12. Standard mail (B) matter not prepaid at First-Class rate erroneously registered	Restricted Delivery	\$	\$	\$
13. Not marked "Registered"	Handling Charge	\$	\$	\$
14. Not numbered (See Item 3 for registration number assigned)	Special Delivery	\$	\$	\$
15. Illegible endorsing or numbering	23. Other irregularity			
16. Not postmarked on back or not postmarked at and over intersection of sealing flaps				
17. Not legibly postmarked				
18. Not accompanied by return receipt				

Figure 7-17.—An example of a PS Form 3826, Registry Irregularity Report.

133 MAIL  
131 OAK SPRINGS PL  
ONTARIO CA 91781

REG. MAIL  
R 184 483 110 2

MSG LAMAR SHAW  
2304L BDE, H-HQ  
UNIT 2001 R, BOX 55  
APO AE 09088

U.S. MAIL 6 81 93 240

Lock No. \_\_\_\_\_ Rotary No. \_\_\_\_\_ Jacket No. \_\_\_\_\_ Control No. \_\_\_\_\_  
 BILL No. 184 Page No. 1X Airmail \_\_\_\_\_ Seal No. 68193240  
 To USS Underway  
 (R.O. or R.P.O. and Tr. No.)

Reg. No., Jacket Lock or Seal No.	Office or ZIP of Origin. Use only for jacket, Lock, or Seal Numbers. Not required for individual Reg. Nos.	Reg. No., Jacket Lock or Seal No.	Office or ZIP of Origin. Use only for jacket, Lock, or Seal Numbers. Not required for individual Reg. Nos.
1 R101483910		16	
2 R882634005		17	
3 R473580371		18	
4 R862007713		19	
5 R374901867		20	
6 R448703211		21	
7 R604993267		22	
8 R770618100		23	
9 R252587002		24	
10		25	
11		26	
12		27	
13		28	
14		29	
15		30	

Bill No. 184  
 A.M. Rte. \_\_\_\_\_  
 & Fil. No. \_\_\_\_\_  
 Jacket No. \_\_\_\_\_  
 Lock No. \_\_\_\_\_  
 Rotary No. \_\_\_\_\_  
 Seal No. 68193240

Received articles described on above-specified bill from dispatching office named in postmark.

\_\_\_\_\_  
 Receiving Clerk

A total of 9 articles sent by this dispatch  
 POSTMASTER, Wit: Larry Brown  
 Martha Kingston  
 9:30 M  
 Dispatching Clerk

A total of 9 articles received by this dispatch  
 POSTMASTER, Wit: George Forrest  
 John J. Doe  
 0830 M  
 Receiving Clerk

Form 3854, Apr. 1985  
 \* U.S. GOVERNMENT PRINTING OFFICE: 193 369-775

Figure 7-18.—An example of properly receiving for articles inside a registered pouch.

PCf0718

dispatching activity after you have applied your APDS. You should forward missent articles to the proper destination by the next dispatch.

- When you receive a bill that is improperly prepared, you should make corrections on the bill and return the coupon explaining the discrepancy to the dispatching activity.
- When a bill is missing, prepare a new bill in duplicate and return the duplicate to the dispatching activity.

## DELIVERY OF REGISTERED MAIL TO ADDRESSEE

After registered pouches have been opened and the contents verified and backstamped, the mail is sorted by unit of address with the exception of personal registered mail, which is set aside for delivery to the addressee or authorized agent.

### Delivery to Mail Clerks and Mail Orderlies

PS Form 3883 is a 3-part set used to deliver a command's official accountable mail to mail clerks

and mail orderlies (see figure 7-19). Prepare this form as follows:

Step 1: Check the block of the type of accountable mail to be delivered.

Step 2: Enter the name of the unit of address or activity and the bill number. Bill numbers should be in sequence starting with the number 1 each calendar year.

Step 3: Enter the registered numbers of the articles to be delivered (maximum of 20 per PS Form 3883), complete the code block by following the instructions in the \* block below the 20 line entry spaces, and enter the office of origin.

Step 4: Close the bill by drawing a diagonal line through the unused portions of the bill.

Step 5: Enter the date of delivery.

Step 6: Delivery clerk signs name in this space.

Step 7: Postmark with the APDS all copies of the set.

Step 8: Mail clerk or mail orderly enters total number of articles received.

Step 9: Mail clerk or mail orderly prints then signs name.

Before making any entries the receiving mail clerk or mail orderly must show a validated DD Form 285 (Appointment of Military Postal Clerk, Unit Mail Clerk, or Mail Orderly). The mail clerk or mail orderly must verify that the registry numbers of the articles are properly listed before signing PS Form 3883. Once the

Figure 7-19.—An example of a PS Form 3883.

verification has been made and the mail clerk or mail orderly has signed, the customer copy 3 of the form is given to the mail clerk or mail orderly and the original and copy 2 are retained for post office records.

### **Delivery of Registered Mail to Addressee or Authorized Agent**

Personal registered mail will normally not be delivered to mail orderlies on PS Form 3883, but can be delivered to mail clerks who deliver mail from a unit mailroom. Instead, PS Form 3849 should be used to notify the addressee of registered mail arrival. The form is prepared and given to the unit mail clerk or mail orderly for delivery to the addressee. PS Form 3849 (see figure 7-20) is prepared in one (1) copy. The steps in completion of this form are as follows:

Step 1: Enter the current date.

Step 2: Enter sender's name.

Step 3: Mark an "X" in this box and enter your FPO address.

Step 4: Fill in the date and time that the article will be available for pickup. (The time is usually the time your post office is open for business.)

Step 5: Check the box that describes the article being delivered.

Step 6: Check the appropriate accountable mail box.

Step 7: This box must always be checked. Accountable mail should always be signed for.

Step 8: Enter the registered number of the article including the letters RR and US.

Step 9: Enter the complete name and address of the addressee.

Step 10: Customer signs and prints name here at time of delivery.

Step 11: Delivery clerk signs name and enters date of delivery.

Items listed below are key points to remember when delivering accountable mail:

- Positive identification is required.
- Only the addressee or an authorized agent may sign for personal accountable mail.

There are instances when the addressee is unable to come to the post office to receipt for registered mail. The addressee may authorize an agent in writing, in this case, to receipt for their registered mail. Military

postal clerks, mail clerks, and mail orderlies are prohibited from acting as agents in this regard. The back of the PS Form 3849 has a space for the addressee to authorize an agent to sign for his or her registered mail. When the back of the form is used, the addressee completes the form (see figure 7-20) as follows:

Step 12: Enters the name of the person who is authorized to receipt for the registered article.

Step 13: Signs the form.

When the authorized agent presents the form to the registry section, delivery is effected in the same manner as when the addressee presents the form. The only difference is that the agent signs and prints their name on the form in the delivery section on the reverse side of the form.

### **Return Receipts**

If a return receipt is attached to the registered article, the receipt will be signed and dated by the addressee or authorized agent. The receipt should be returned promptly to the source from which it was received.

### **DELIVERING DAMAGED REGISTERED ARTICLES**

All damaged personal registered articles should be rewrapped and the endorsement RECEIVED IN DAMAGED CONDITION stamped on the article. The registry clerk rewrapping the article should initial and date the endorsement.

### **UNDELIVERABLE REGISTERED MAIL**

The two most common reasons for undeliverable registered mail is that the addressee has transferred from the unit or is due to arrive. Normally, registered mail received will be deliverable upon receipt. However, if a member has transferred, perform directory service on the registered article and annotate the reverse side of PS Form 3849 by checking the forward box and file it in the MPO files. Forward the registered article on the next dispatch of outgoing mail. If a registered article arrives for a person who is due to report, holding time frames for registered mail must be adhered to.

### **Indication of Due to Report**

When registered mail is received for an individual who is not attached to the command but there is an

United States Postal Service  
**Sorry We Missed You! We <sup>PS</sup> Deliver for You** Today's Date (1) Sender's Name (2)

Item is at: (3) Available for Pick-up After (4) **We will redeliver or you or your agent can pick up. See reverse.**

Date: Time: (7) **If checked, you or your agent must be present at time of delivery to sign for item**

(5) Letter For Delivery: (Enter total number of items delivered by service type)  
 Large envelope, magazine, catalog, etc. For Notice Left: (Check applicable item)  
 Parcel Express Mail (We will attempt to deliver on the next delivery day unless you instruct the post office to hold it.) Registered Insured  
 Restricted Delivery Return Receipt for Merchandise Delivery  
 Perishable Item Certified Confirmation Signature Confirmation  
 Other: Recorded (6) Firm Bill

Article Number(s) (8)

**Notice Left Section**  
 Customer Name and Address (9)

Article Requiring Payment Amount Due  
 Postage Due  COD  Customs \$  
 Final Notice: Article will be returned to sender on Delivered By and Date (11)

PS Form 3849, November 1999 102595-00-M-0892 Delivery Notice/Reminder/Receipt

We will redeliver OR you or your agent can pick up your mail at the post office. (Bring this form and proper ID. If your agent will pick up, sign below in item 2, and enter agent's name here):

1. a. Check all that apply in section 3;  
 b. Sign in section 2 below;  
 c. Leave this notice where the carrier can see it. (12)

2. Sign Here to Authorize Redelivery or to Authorize an Agent to Sign for You: (13)

3.  Redeliver (Enter day of week.):  
 (Allow at least two delivery days for redelivery, or call your post office to arrange delivery.)  
 Leave item at my address  
 (Specify where to leave. Example: "porch", "side door". This option is not available if box is checked on the front requiring your signature at time of delivery.)  
 Refused  Forward  Return

**Delivery Section**  
 Signature X  
 Printed Name (10)  
 Delivery Address

**USPS**   
 5290 0021 7049 5170

PS Form 3849, November 1999 (Reverse)

PCf0720

Figure 7-20.—An example of a PS Form 3849 (Front and Reverse).

indication that the person is due to arrive, then the following handling procedures apply:

- Complete PS Form 3849 and annotate the date on the article, then initial it. The registered article should be stored in the registry section, while the PS form is placed in the directory section for weekly screening against directory files.
- Hold undeliverable registered mail no more than 15 days (30 days if requested by sender).
- If unclaimed at that time and there is no further indication that the individual is due to arrive at a later date, then dispose of mail by placing the endorsement ATTEMPTED—NOT KNOWN on the face of the article and return the mail to the sender.

- Complete the office record portion on the reverse side of the PS Form 3849 showing the disposition of the article.

### Initiating Final Notice

If registered mail has not been called for after 5 days from initiating PS Form 3849, prepare a second PS Form 3849 in the same manner as the first notice. Annotate on the article the date the second notice was prepared and the date the article will be returned to sender.

### No Indication of Due to Report

If registered mail is received for a person for whom there is no indication of a due-in date, and there is reason to believe the individual is due to arrive since mail is being forwarded with the same last name, or some other reason, hold for 15 days. If the mail is still undeliverable at the end of the hold period, and there is no further indication that the individual is due to arrive at a later date, the mail should be endorsed ATTEMPTED—NOT KNOWN and returned to the mailer. A PS Form 3849 is completed showing on the reverse side the disposition of the article.

### Forwarding Registered Mail

If a registered article has not been called for after 5 days from initiating the second notice, then a verification of the addressee's status should be made through the receiving unit/division. The disposition of the undeliverable registered article should be made according to the forwarding instructions received from the unit or division or from information on the member's directory card (OPNAV Form 5110/5), or the computerized directory file. The registry clerk should copy the new address on the face of the registered article in the lower right-hand corner, and draw a single diagonal line through the incorrect portions of the old address. Be certain not to line out the name and rate of the addressee, the registration number, the postmarks, or other pertinent information. Registered articles that are being forwarded are backstamped once with the APDS and dispatched under the original registration number and office of origin. If a return receipt is attached to the article, ensure it remains attached to the article when forwarded. The particulars of forwarding should be shown on the reverse side of the PS Form 3849. The form should be signed and dated by the registry clerk who forwards the registered article and completes the form.

### Filing PS Form 3849

After the registered article has been delivered to the addressee, forwarded, or returned to the mailer, the

completed PS Form 3849 is retained in the post office records. These forms may be commingled in a single file with other PS Form 3849's documenting the disposition of insured and certified articles; however, a separate file may be established for registered articles if volume warrants. File the forms numerically by the last two digits of the registered number and retain for 2 years before destroying. Depending on volume of registered mail received, it is recommended that a new file be started at the beginning of each quarter or calendar year.

- Q7-22. What publication states that registered mail transferred at sea must be transported via weighted, nonwatertight bags?*
- Q7-23. What are the two major concerns when irregularities are reported in registered mail dispatches?*
- Q7-24. What PS Form is identified as a Registry Irregularity Report?*
- Q7-25. What procedures should you follow when your MPO receives a registered mail pouch and registered articles are not listed on the inside bill?*
- Q7-26. PS Form 3883 is used to deliver official registered mail to mail orderlies. (True/False)*
- Q7-27. Personal registered mail should be delivered using PS Form 3849. (True/False)*
- Q7-28. A final notice on a personal registered article should be initiated how many days after the second notice is issued?*
- Q7-29. PS Form 3849s are filed by the last two digits of the registry number. (True/False)*
- Q7-30. For what specific period of time must a completed PS Form 3849 be retained in the MPO files?*

Now turn to appendix 1 to check your answers.

## CLOSING THE REGISTRY SECTION

---

**Learning Objective:** *Recall the steps involved for closing and accounting for the registered mail cage.*

---

In this chapter, you have learned how to process incoming and outgoing registered mail. However,



your job is not finished. The last task performed by the registry clerk before closing the registry section or before the changing of shifts is to account for all registered mail processed during the business day. You show accountability of all registered items by preparing DD Form 2261, Registered Mail Balance and Inventory.

## **DAILY ACCOUNTABILITY**

Daily accountability involves completing a DD Form 2261 by using incoming and outgoing bills, and other forms received or prepared during the workday that shows registered mail received, delivered, dispatched; and mail on hand at the close of business or shift change. When the DD Form 2261 is completed and signed by the registry clerk, the MPO supervisor or designated individual verifies and signs the DD Form 2261 indicating it is correct.

### **Balance Sheet**

The size and hours of operation of your MPO will determine when the balance of registered mail will be conducted. For an FMC operation, this must be done at the end of each shift. A one-person MPO must balance the registered mail at the end of each workday. DD Form 2261 (see figure 7-21) should be used to make the appropriate entries that pertain to your volume of registered mail processed during the shift or day. The following procedures will apply in the completion of the balance sheet:

Step A: Enter the preparing activity FPO number.

Step B: Enter the year, month, date, and hours of the operation in the registry section. Example From: 000930/1600 To: 000930/2300.

Step C: After verifying the registered numbers, enter number of registered articles remaining on hand from the previous day or shift. These are articles that were not delivered or dispatched, and were stored in the registry section overnight; or in a shift change, these are the articles on hand when you take over the shift.

Step D: Enter the total number of articles received on PS Form 3806, PS Form 3877, or PS Form 3883.

Step E: Enter the total number of articles received on all incoming inside bills.

Step F: Enter the total number of articles listed on incoming manifests.

Step G: Enter the total number of articles received on incoming truck bills.

Step H: Enter the number of pouches you prepared and closed for dispatch.

Step I: Enter the number of articles received from window clerks on transfer bills. Registered articles found in ordinary mail are also entered here.

Step J: Enter the total number of articles listed in blocks 1 through 7.

Step K: Enter the total number of articles delivered on PS Forms 3849 and 3883.

Step L: Enter the total number of articles listed on outgoing inside bills.

Step M: Enter the total number of articles listed on outgoing manifests.

Step N: Enter the total number of articles dispatched on outgoing truck bills.

Step O: Enter the number of pouches opened by the registry clerk and witness.

Step P: Enter the number of articles on hand at the end of the business day that were not delivered or dispatched.

Step Q: Enter the total number of articles listed in blocks 9 through 14. This total must be the same as the total shown in block 8.

Step R: Enter the registered number of each article delivered on PS Form 3849.

Step S: At the close of business or shift change, inventory and list (by registered number) each item on hand on the reverse side of DD Form 2261.

Step T: Enter the printed name of each clerk working in the registry section during the period. This is normally the witness and the registry clerk.

Step U: The registry clerk signs here.

Step V: The supervisor or designated individual will sign here indicating that all entries have been verified and are correct.

Step W: The next registry clerk assuming responsibility for the registry section will print name, pay grade, and sign in this section after inventorying and verifying the articles listed on the reverse side of the DD Form 2261.

When a balance cannot be attained, recheck the computations of each entry against the related forms processed during the period. Next, determine that a form is on hand for each transaction performed. If necessary, go back to the previous balance and

REGISTERED MAIL - BALANCE AND INVENTORY					
PREPARING ACTIVITY (A)			PERIOD COVERED (yr, mo, day, hr)		
			FROM	(B)	TO
PART I - NUMBER OF ITEMS PROCESSED					
SECTION A - ON HAND, ACCEPTED, RECEIVED AND PREPARED FOR DISPATCH			SECTION B - OPENED, DELIVERED, DISPATCHED AND ON HAND		
1	ITEMS ON HAND AT START OF PERIOD	(C)	9	ITEMS DELIVERED ON PS FORM 3849 AND 3883	(K)
2	ITEMS ACCEPTED ON PS FORM 3806 AND 3877 AND RETURNED FROM UMC ON PS FORM 3883	(D)	10	ITEMS LISTED ON INSIDE BILLS (PS Form 3854)	(L)
3	ITEMS LISTED ON INSIDE BILLS (PS Form 3854)	(E)	11	ITEMS LISTED ON OUTGOING MANIFESTS	(M)
4	ITEMS LISTED ON INCOMING MANIFESTS	(F)	12	ITEMS LISTED ON OUTGOING TRUCK BILLS	(N)
5	ITEMS LISTED ON INCOMING TRUCK BILLS	(G)	13	NUMBER OF POUCHES/JACKETS OPENED	(O)
6	NUMBER OF POUCHES/JACKETS CLOSED	(H)	14	ITEMS ON HAND AT END OF PERIOD	(P)
7	ITEMS RECEIVED FROM OTHER SOURCES	(I)	15	TOTAL OF ITEMS 9 THROUGH 14 (this total must be the same as the total shown in item 8)	(Q)
8	TOTAL OF ITEMS 1 THROUGH 7	(J)			
SECTION C - INVENTORY BY NUMBER OF EACH ITEM DELIVERED ON PS FORM 3849 (continue in remarks if necessary)					
(R)					
PART II - REMARKS					
(T)					
PART III - VERIFICATION AND TRANSFER OF ACCOUNTABILITY					
I VERIFY THAT ALL ENTRIES ON THIS BALANCE AND INVENTORY ARE CORRECT					
SIGNATURE OF PERSON PREPARING FORM			SIGNATURE OF VERIFYING OFFICIAL		
(U)			(V)		
I ACKNOWLEDGE RECEIPT OF ALL REGISTERED ITEMS LISTED ON THIS INVENTORY					
TYPED/PRINTED NAME OF ACCEPTOR (last, first, MI)		PAY GRADE	SIGNATURE		
(W)					
DD Form 2261, JAN 82 (EG) REPLACES DA FORM 4366, AUG 76, WHICH IS OBSOLETE. Designed using Perform Pro, WHS/DIOR, Dec 94					
(S)					
DD Form 2261 Reverse, JAN 82					

PC10720

Figure 7-21.—An example of a DD Form 2261 (Front and Reverse).

inventory and begin a crosscheck of the numbers for each transaction since that time.

If, upon completion of a recheck, the balance and inventory still indicates a registered item is missing, you should identify the number of the missing item and source from which it was supposedly received and perform the following:

- If the mailer is served by your activity, notify that person that the article is missing and determine if the article may have been accidentally returned.

- If the mailer's response is negative, you should then contact all units or activities to which registered articles were dispatched during the reporting period. Determine if the item may have been included in a pouch, but not listed on the bill, or if the item was accepted in error.
- In cases where the mailer is not served locally, you should contact the dispatching activity by phone, E-mail, or naval message.

- A letter or naval message should be sent to the accountable postmaster or postal officer of the dispatching activity with instructions to notify the mailer of the possible loss. In addition, you should also request:

—The name and address of the mailer and addressee;

—Information on the contents of the missing item;

—Information on the classification, if the missing item was official mail; and

—Evidence that the addressee has or has not received the item.

If a reply is received verifying the article was received, then you should prepare PS Form 3849 and file the form with the registry records. In the event that all the actions above failed to locate the missing registered item, you should then begin to initiate a postal offense investigation as directed in the *DOD Postal Manual*, Volume I, and OPNAVINST 5112.6.

Supporting documentation for registry transactions should be maintained for 2 years.

### **Transferring Accountability**

Fleet mail centers should use DD Form 2261 to transfer accountability between registry clerks upon change of shifts or any time a registry clerk surrenders custody of registered items. When only one clerk operates the registry section, it should be closed during periods of temporary absences, or if possible, temporarily transferred to another Postal Clerk. The transfer should be done by completing PS Form 3854 in two copies listing the registry pieces on hand by assigned registry numbers. The bills should be numbered consecutively, starting on 1 January of each year. The original copy should remain in the MPO files and the clerk being relieved should retain the duplicate copy. When the regular clerk returns, the procedure is repeated.

If the acceptance window is a separate operation from the registry section, accountability is transferred to the registry clerk, using PS Form 3854. Accepted registered articles need not be transferred as they are taken in through the finance section. The registered articles may be stored in a safe or a secured cabinet in the immediate proximity of the accepting finance clerk. Depending on the local operating schedule of the MPO's registry section, transfer of registered mail

between the finance section and registry section should be made at the close of each business day or when required by the outgoing registry mail scheme for the MPO or FMC.

### **REGISTRY CAGE**

When it is necessary for the handling and storage of large quantities of registered mail, a security cage may be provided within the post office or other secure space. Postal activities that handle and store registered mail should designate a secure area as the registry section. The registry section for land-based permanent structure MPOs must be built and equipped to provide the adequate security measures needed for the protection of registered mail. The registry section should be separated from the rest of the work areas by a wire partition extending to the ceiling or provided with a wire top. Small land-based and shipboard MPOs may be exempt from the requirements to build a separate registry section because of the physical constraints that make it impractical or impossible. When an MPO does not have a separate registry section, precautions must be taken to see that registered mail is kept separate from ordinary mail and protected from damage or theft.

### **Security of the Registry Cage**

The registry cage must be properly manned or secured at all times. The registry section must also, unless staffed at all times, be equipped with a safe with a built-in three-position, dial-type combination lock for the storage of official registered mail. To maintain proper security, the following policies must be complied with at all times:

- Containers used for official registered mail should not be used to store postal effects or personal property.
- During business hours, the container and the registry section must be secured when not in direct control of registry clerks.
- After business hours and during nonduty hours, official registered mail must be stored in an authorized secure container within the registry section, if possible.
- Opening and closing of registry safes must be documented and a security review conducted at the close of registry business each day.

## **Access to Registry Work Areas**

Only registry clerks on duty, witnesses, the section supervisor, and personnel authorized to inspect and audit DoD postal facilities are allowed entry to the registry section work area. The on duty registry clerk or clerks must control access to the area. A log should be kept by the shift registry clerk and anyone entering the space should be logged in and out as appropriate. PS Form 1625, Record of Entry-Registry Section, is designed for this purpose and must be used.

## **Combination Locks**

The registry cage must be secured by a three-position, changeable combination padlock. The registry section should also have a safe with a built-in, three-position, dial-type combination lock for the storage of official registered mail. The use of a secure container that can be locked by using a General Services Administration (GSA) approved three-position, changeable combination padlock is permissible instead of a safe. This GSA-approved padlock can be procured through the Navy supply system.

Postal facilities such as fleet mail centers (FMCs) that run on a shift basis must provide each shift with a separate GSA-approved three-position, changeable combination padlock.

## **Recording and Storing Combinations**

The combinations to the registry cage, safes, and containers should be sealed in PS Form 3977, Duplicate Key Envelope. The name of the responsible individual, the description of the contents, and the location of the applicable container should be placed on the face of the envelope. The signatures of the individual to whom the container is assigned and the COPE, MPO supervisor, or other designated individual should be placed across the flap of the envelope and the envelope dated with the APDS.

*Q7-31. Who is responsible for completing the DD Form 2261 at the end of the business day?*

*Q7-32. What type of lock should be used to secure a registered mail cage?*

Now turn to appendix 1 to check your answers.

## CHAPTER 8

# POSTAL FINANCE

As a military postal clerk, one of your jobs may be that of a window clerk. About 70 percent of all window transactions involve the sale of stamps or postal stationery items. Before you can perform duties as a window clerk, you must be issued a stamp stock, commonly referred to as a fixed credit account. Did you ever stop to think how stamps are obtained or the purpose of the stamps? The postage stamps that are affixed to an article indicate that the charge for handling, transporting, delivering the article, and fees for special services (if selected by the mailer) have been prepaid. In this chapter you will learn how to order stamps for a fixed credit account from the custodian of postal effects (COPE), the Navy Postal Finance Office (NPFO), or a postal finance office (PFO) overseas. You will also learn how to properly account for the stamps.

Additionally, you will learn the fundamentals of the money order imprinter, postage meter machine and the integrated retail terminal (IRT). As a window clerk assigned to a post office aboard a large ship or at an overseas naval activity, you may be required to operate each of these types of equipment.

### POSTAGE STAMPS AND STAMPED PAPER

---

**Learning Objective:** *Identify and validate the forms of issue for postage stamps.*

---

Postage stamps and stamped paper are often referred to as stamp stock. In this next section, we will discuss the validity of stamps, forms of issue, types of postal stationery, and the care and protection required for stamp stock and postal monies.

#### VALIDITY OF STAMPS

Any uncanceled postage stamps issued by the United States since 1860 may be used for postage. All valid United States postage stamps are good for postage from any point in the United States or from any other place where the United States domestic mail

service operates. The following stamps may NOT be used for postage:

- Mutilated or defaced stamps
- Stamps cut from stamped envelopes, aerogrammes, or stamped cards
- Stamps covered or coated in such a manner that the canceling or defacing marks cannot be imprinted directly on the stamps
- Nonpostage stamps (migratory-bird hunting and conservation stamps, U.S. savings and thrift stamps, and so forth)
- Postage due, special delivery, special handling, and certified mail stamps
- United Nations stamps unless on mail deposited at the United Nations, NY
- Stamps of other countries
- Stamps on which any unauthorized design, message, or other marking has been overprinted

Matter bearing imitations of postage stamps, in adhesive or printed form, or private seals or stickers that are similar to a postage stamp in design, should not be accepted for mailing. However, seals or stickers that do not imitate postage stamps may be attached to other than the address side of mail.

#### FORMS OF ISSUE

Adhesive postage stamps are available in four different forms: single, sheets, books, and coils. At the time of purchase, if the customer does not specify a form of issue, you should ask the customer which preference is desired. A discussion of the available forms follows.

##### Single

Single stamps are separated from a sheet of stamps, and they can be sold in any number up to a full sheet.

## Sheets

The number of stamps to a sheet varies, depending upon the size of the stamps. Sheets of ordinary postage stamps and postage-due stamps consist of 100 stamps per sheet. Stamps such as commemorative stamps and certain other various denominations usually consist of 50 stamps per sheet or other amounts per sheet as announced in the Postal Bulletin.

## Books

Books of stamps are sold for protection and convenience. The stamps are self-adhesive and are protected to prevent the stamps from sticking together. When ordering books of stamps, refer to Module R of the DMM for current available denominations.

## Coils

Stamps are issued in coils for use by customers who find this method more convenient to use than loose stamps, sheets, or books of stamps. MPOs stock 100-stamp coils. Postage at the First-Class letter rate, stamped card rate, and ordinary postage in several of the lower denominations are available in coils. Stock only those denominations in coils that your customers request. Also, never open coils because they must be sold intact for the total stamp value. Stamp dispensers to hold coils of 100 stamps may be purchased by postal customers from MPOs.

## KINDS OF STAMPS

The Postal Operations Manual (POM) divides postal adhesive-backed stamps into three basic types, according to the purpose for which they are intended. The types are as follows:

- Regular (Definitive) stamps
- Commemorative stamps
- Special stamps

Some information on each of these stamps appears below, including the purpose and forms of issue.

### Regular Stamps

The largest quantity of stamps in your fixed credit account will be in regular stamps. Regular stamps are issued in denominations ranging from \$.01 to \$5. There is also an Express Mail stamp that currently is in the denomination of \$11.75. Only overseas

shorebased post offices stock Express Mail stamps. You will not need all the different denominations available and should only stock those denominations that fit the needs of your postal customers. However, you should keep a varied amount of higher value stamps on hand for parcels that you accept for mailing.

Regular stamps may be used to pay for registration, certified mail, insurance fees, and special handling. In fact, they may be used for any mailing charge. They should be kept in constant supply for ordinary postal needs.

### Commemorative Stamps

Commemorative stamps are issued in observance of historical events, to honor noted persons, and to emphasize topics of national importance or interest. Each issue is printed in limited quantities to be sold for a limited period of time. Commemorative stamps do not replace regular stamps but are sold upon request, when available.

New commemorative stamp issues are announced by notices in the Postal Bulletin. These notices should be displayed in post office lobbies for customers to see. Each MPO should have commemoratives on hand.

### Special Stamps

Special stamps supplement each year's regular issue. They include the Love and Holiday stamps. Each year the USPS announces by notices in the Postal Bulletin the availability and sale dates of holiday stamps. MPOs should order these stamps early.

- Q8-1. Uncanceled United States postage stamps may be used for postage if they were printed after what year?*
- Q8-2. Postage stamps of foreign countries may not be used as postage for U.S. domestic mail. (True/False)*
- Q8-3. List the four different forms of adhesive postage stamps available for purchase.*
- Q8-4. What is the maximum number of regular postage stamps that make up a sheet?*
- Q8-5. What is the purpose of selling postage stamps in book form?*
- Q8-6. How many postage stamps make up a coil?*
- Q8-7. Postal Clerks should not open coils because they should be sold intact for the total stamp value. (True/False)*

- Q8-8. *The Postal Operations Manual divides adhesive-backed postage stamps into three basic types. Name the three types.*
- Q8-9. *Regular stamps are issued in what minimum and maximum amounts?*
- Q8-10. *What is the purpose of commemorative stamps?*

Now turn to appendix 1 to check your answers.

## **POSTAL STATIONERY**

---

**Learning Objective:** *Recall the different types of postal stationery available at an MPO.*

---

Aerogrammes, stamped cards, and stamped envelopes are examples of postal stationery. Each of these items may be issued to you as part of your postage stock. Remember that prices on postal stationery are subject to change, and you should keep yourself informed as to the current selling price of aerogrammes, stamped cards, and stamped envelopes.

The DMM, IMM, and Postal Bulletin are the references for this information.

## **AEROGRAMMES**

Aerogrammes (air letter sheets), which can be folded into the form of an envelope and sealed, may be sent by air to all countries. These sheets, bearing imprinted postage, can be sold at all post offices. Enclosures are NOT permitted. The use of tape or stickers to seal aerogrammes is prohibited. Aerogrammes may be registered after payment of a registry fee. Refer to the IMM for the current price.

## **STAMPED CARDS**

The USPS supplies stamped cards with a postage stamp printed or impressed on it for the purpose of transmitting a message. The USPS sells two stamped cards; one is a double stamped card with one half of the card being a reply card, the other is a single card. Your MPO will normally only stock single-piece rate stamped cards. Selling price for the stamped cards is the First-Class rate of postage for a single card, double that for a double reply-paid card, plus an additional charge for the card or double card. Refer to Module R of the DMM for the current prices for stamped cards.

## **STAMPED ENVELOPES**

Stamped envelopes are made of high-grade paper that will withstand any ordinary handling to which a letter may be subjected. Stamped envelopes are available in plain or personalized format with four different types each. Your MPO will normally only supply plain stamped envelopes.

Regular plain stamped envelopes are available at the First-Class postage rate plus a charge for the envelope. At the time this manual was written, this cost was .33 cents for the postage and .07 cents for the envelope; total cost to customer of .40 cents. Two sizes are available, size No. 6-3/4 and size No. 10. Single stamped envelopes, in either size, are sold at the same price; refer to Module R of the DMM for the current price. Discount prices are available when arrangements are made for individuals to purchase envelopes in multiples of 500.

## **CARE AND PROTECTION OF STOCK AND FUNDS**

---

**Learning Objective:** *Recall the procedures for properly caring for postal effects.*

---

Stamps, postal stationery, and other accountable items must be protected at all times. At the finance window, keep your funds and stock stored in a cash drawer that will accommodate the different denominations of coins, bills, and the postage stock items of the highest demand.

Cash drawers are designed to keep postal stock beyond the reach and sight of the customers. For security reasons you must always lock your cash drawer during temporary absences from the window. At night and when the post office is closed, place all funds and stamp stock in your assigned safe.

Duplicate combinations and keys to cashboxes, cash drawers, or safes in which funds and postal stock are stored, should be sealed in PS Form 3977s, Duplicate Key Inventory (Envelope). They must be safeguarded by the COPE (unless you are the COPE then by another designated individual). PS Form 3977s should be receipted for on a modified PS Form 1096 (Cash Receipt).

You should place your name, the description of the contents, and the location of the applicable container on the face of the envelope(s). In addition, your signature and the signature of the designated

individual should be placed across the flap of the envelope and the envelope dated with the APDS.

Each clerk should be assigned a separate cashbox or safe when in custody of any portion of the command's fixed credit.

Military postal clerks having custody of funds and stock can be held liable for their loss when they do not comply with handling and storing instructions. NEVER allow another Postal Clerk (junior or senior) to sell or make window transactions from your cash drawer.

Combinations to safes used to store funds and stock should be changed:

- Upon initial receipt of the safe
- Whenever there is a compromise of the combination
- Whenever an individual who has had custody of the combination is transferred or relieved of credit
- Annually

### ARRANGEMENT OF STOCK

Any workable arrangement of stamp stock, consistent with security and protection standards, is permissible. The following procedures may prove helpful to you in arranging your stamp stock.

- For convenience keep the stamps in a large scrapbook, the pages of which are slightly larger than the sheets of stamps. Place individual denominations between the pages in numerical order, or in order of the most frequently sold stamps. Tab the pages with each denomination.
- Keep stamps flat. Use a book, a piece of cardboard or flat metal, or any other heavy object to keep the stamps from buckling and curling. In humid climates and during the summer, it may be helpful to place sheets of waxed paper between the sheets of stamps to prevent them from sticking together.

Your stamp drawer will have compartments for coins and bills. Place the coins in the front compartment where they will be accessible to you for making change. Place the bills in the large compartments. If space is available, keep your books of stamps in the stamp drawer also.

Keep your envelopes and stamped cards in a large compartment near your stamp window. Never open

more than one box of a kind at a time; when your stock is audited, unopened boxes are much easier to count.

You will sell stamps over a counter or through a window, depending upon the size and layout of your post office. In many offices the counter may serve as both the stamp window and parcel post counter.

### SELLING STAMPS

Postal counter work is one of the most important tasks you will perform. This type of duty is essentially one of public contact, and it requires businesslike behavior and service that is COURTEOUS and EFFICIENT. A thorough knowledge of postal regulations concerning the types of postal services offered and the appropriate postage rates is a must.

Always remember to collect the money before handing out the stamps. You should keep the money handed to you in sight until the transaction has been completed. This will avoid any confusion or disagreement between you and the customer about the amount you were given. After you have made change, count it out to the customer. This will serve to double-check your computation. You should complete all necessary postal financial transactions in the presence of the customer.

When you are selling stamps, especially those for use on a package, always use those of the highest suitable denomination. For example, don't use eight \$.25 stamps when two \$1 stamps would suffice. Do not damage or soil your stamp stock. Sell your older stock first to minimize spoilage.

### SEPARATING AND DELIVERING STAMPS

Before separating a sheet of stamps, crease them on the lines along which you will separate. Then separate along the perforations, being careful not to tear any stamps. Start at the top and tear down (see figure 8-1). Separating from bottom to top usually results in stamps becoming torn.

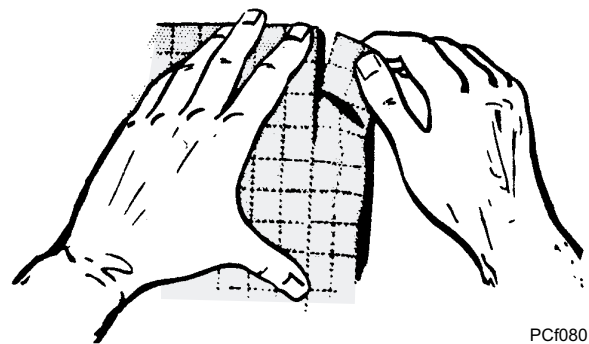

PCF0801

Figure 8-1.—Separating stamps.



## AFFIXING STAMPS

Military postal clerks are not permitted to affix stamps to mail. The mailer of the article must affix the stamps and should be so informed should the question arise. Inform your patrons, when necessary, that the stamps must be affixed firmly in the upper-right corner of the address side of the article. Any stamp partially concealed by an overlapping stamp may not be counted as postage.

## UNAUTHORIZED TRANSACTIONS

---

**Learning Objective:** *Recognize unauthorized uses of stamp stock funds.*

---

It is unlawful for those of you entrusted with the sale or custody of postage stamps to use the stamps in payment of debts or expenses or for the purchase of any salable articles. Stamps must be sold for cash, but not for more or less than face value.

At post offices where automated records of all daily financial transactions are not maintained, stamp stock funds must be kept entirely separate from all other funds in a clerk's possession, and must not be commingled with stamp stock funds in the custody of anyone else. Postal clerks at large overseas post offices that use Integrated Retail Terminals (IRTs) co-mingle their funds. Clerks using IRTs print out a tape at the end of the day that identifies the amount of funds generated from stamp, meter, and money order sales. This negates the requirement to separate funds for different postal transactions.

Your personal property and funds must not be stored in any container(s) assigned for the safeguarding of postal effects. In fact, postal clerks are not authorized to store any personal items in an MPO, and must not accept deposits of money or other articles for safekeeping from anyone.

- Q8-11. List three types of postal stationery.*
- Q8-12. Explain the purpose of a stamp or cash drawer.*
- Q8-13. What rule should you, a military postal clerk, follow when you need to walk away from your stamp stock for a short period of time?*
- Q8-14. When improper handling and storage procedures cause the loss of postal funds, what liability do military postal clerks hold?*

Now turn to appendix 1 to check your answers.

## FIXED CREDIT

---

**Learning Objective:** *Recall the steps in establishing and maintaining a fixed credit.*

---

Stamps and postal stationery are issued by the Navy Postal Finance Office (NPFO) in San Diego, CA, or through a designated postal finance office (PFO) overseas to MPOs in the form of fixed credit.

The total amount of fixed credit carried by a Navy MPO depends upon the number of crewmembers to be served. As a general guide, this amount is calculated at a minimum of \$25 per person with a minimum amount of \$5,000 for a command. Normally the COPE only retains enough of the fixed credit to conduct day-to-day operations and the remainder is held by the reserve custodian and receipted for on PS Form 3369, Consigned Credit Receipt, in duplicate. The COPE retains the original of the PS Form 3369 and the reserve custodian is given the duplicate.

As stamps are sold, the cash from stamp sales becomes part of the fixed credit. As the amount of stamps on hand decreases, the amount of cash on hand increases, but the total fixed credit remains constant. The funds are remitted, by check, to the NPFO or PFO when new stock is ordered, and upon receipt, the stamps become a part of the fixed credit, and the cycle starts again.

When audited, the COPE must always be able to produce the full amount of the fixed credit in stamp stock, including in transit stamp requisitions and funds.

## ESTABLISHING ORIGINAL STAMP STOCK

The procedures for requesting establishment of an MPO are contained in OPNAVINST 5112.6. These procedures include establishing your original fixed credit.

The amount of the original stamp stock desired by the commanding officer is specified in the letter that requested the Navy post office to be established. This amount should be increased in proportion to the size of the crew. For example, an aircraft carrier would carry an approximate total fixed credit of \$100,000, and a DDG would carry approximately \$5,000.

## RECEIPT OF ORIGINAL STAMP STOCK

When a shipboard Navy post office is established, the designated COPE receives the initial fixed credit

from the NPFO. The initial stamp stock is not usually mailed to the ship or Prospective Commanding Officer until a designated postal clerk is available to receipt for it. Overseas shorebased commands establishing a post office receive their fixed credit from the servicing PFO.

The shipment of original stock is normally addressed to the commanding officer and received on board before the requested effective date of establishment. Upon receipt, the reserve custodian assigned in writing by the commanding officer signs for the stock on PS Form 3883. Then the reserve custodian opens the stock in the presence of the COPE. The reserve custodian and COPE will verify the contents of the shipment against the enclosed invoice (PS Form 17) to ensure that the contents agree with the items listed. After verification has been completed, the COPE will enter the registered number(s) under which the stock was received and the date of receipt on the invoice. Then the COPE and reserve custodian sign the PS Form 17s enclosed with the stamp stock. The reserve custodian signs as the person receiving the stock, and the COPE signs as the witness. The COPE retains the invoice in the MPO files for record purposes and returns the duplicate copy to the NPFO or PFO.

If the space designated as the ship's post office is accepted by the command, then the postal effects; i.e., stamp stock, blank money order forms, postal supplies and equipment, are stored in the post office until the first day of business actually commences. If the space has not been accepted then the postage stock, blank money order forms and money order imprinter should be stowed in a safe issued to the Supply Officer. Prior to opening the post office:

- The command monies audit board must conduct an official audit and record the results on DD Form 2259, Report of Audit of Postal Accounts. This report must be prepared and submitted on the authorized date of establishment of the MPO to show the status of the postal effects on that day. An original and two copies are prepared. Upon completion of the forms, the COPE and the designated auditors must sign all copies.

—In addition to the DD Form 2259; PS Form 3369, receipting for the entire fixed credit and the Supplies and Equipment Receipt (PS Form 1590) receipting for all capital and sensitive equipment are completed and signed by the COPE.

The original DD Form 2259, original and one copy each of PS Form 3369 and PS Form 1590 must be

forwarded to the NPFO or PFO. A suspense copy of each form is retained in the MPO. Once the signed copies of PS Form 3369 and 1590 have been returned, destroy the file copy and file the signed copy.

Other actions (not relating to the fixed credit) that have to be completed when establishing a new post office are as follows:

- Confirm receipt of blank money order forms by sending the duplicate copy of the enclosed PS Form 17s to the NPFO or PFO
- Initiate DD Form 885 for the blank money order forms
- Prepare the post office standard operating procedures (SOP)
- Implement directory card files and mail orderly appointments (to include training of mail orderlies)

## **CUSTODY OF FIXED CREDIT**

Remember a safe to secure the fixed credit assigned to you must be obtained before you receive the stock. Also, remember that you will be the sole custodian of the postal effects issued to you, and you are wholly responsible for their safekeeping at all times except when your commanding officer designates in writing a reserve custodian to retain a portion of the fixed credit.

The number of customers you will serve normally determines the actual stamp stock needed to conduct day-to-day postal operations. This amount in most cases will be \$1,000, but it may be increased or decreased when the commanding officer deems it necessary. An increase over \$1,000 requires a letter of authorization signed by the commanding officer.

After the fixed credit for day-to-day operations has been determined, split the stock with the reserve custodian. In the presence of the reserve custodian, verify the amount of the stock, and ensure that the total is correct. When the count has been completed, prepare PS Form 3369 in duplicate for the amount of fixed credit the reserve custodian is retaining for safekeeping. The reserve custodian should sign both copies, retain the duplicate copy, and return the original to you.

So business need not be suspended during your absence for such reasons as leave or liberty, you should issue a portion of the fixed credit to one or more of your assistant military postal clerks. When you extend a

portion of the fixed credit to any of your assistants, the total amount must not exceed \$1,000 per clerk. If an assistant needs to retain more than \$1,000, the specific amount should be authorized in writing by the commanding officer. The correct procedure for extending initial fixed credits to assistant military postal clerks is as follows:

- The COPE prepares and date stamps two copies of PS Form 3369 in the amount of the extended fixed credit.
- The COPE prepares two copies of PS Form 17 indicating the amount and denomination of stock being issued.
- The COPE prepares an account folder for each extended fixed credit that is to be used for the filing of all documentation pertaining to that account.

When the above procedures have been completed, the COPE and the selected assistant MPC(s) jointly verify the amount of stock being issued to ensure that the total is correct. When the count has been completed, the COPE obtains the signature(s) of the clerk(s) on the appropriate forms. The COPE keeps the signed originals of PS Form 3369 and PS Form 17, and the assistant MPC(s) retains the duplicates. In this manner, you will hold receipts for all stamp stock and funds not in your actual custody, whether held by the reserve custodian or by your assistant(s). Considering what you have in your possession and what is in the custody of others, ensure that you maintain a continuous chain of receipts to cover the total fixed credit.

**CHANGE IN CUSTODY**

Whenever there is a change of COPE or when a window clerk is relieved of an account, an audit must

/COMMAND LETTER HEAD/	
	SER 5110 Date:
From: Commanding Officer, USS Underway To: PCSN Able B. Seaman, USN, 777-77-7777	
Subj: AUTHORIZATION TO RETAIN FIXED CREDIT IN EXCESS OF \$1,000.00	
Ref: (a) OPNAVINST 5112.6C (b) DOD 4525.6-M	
1. In accordance with references (a) and (b), you are hereby authorized to retain a total of \$_____ in fixed credit.	
2. This authorization will remain in effect until rescinded in writing.	
/S/ W.T. Door	
Copy to: Service Record Post Office Files	

**Figure 8-2.—An example of a letter authorizing retention of a fixed credit account in excess of \$1,000.00.**

be held on the account. Overages are collected and remitted to the NPFO or PFO. Restitution for shortages must be made at the time of the audit.

### **AUTHORIZATION LETTER FOR RETENTION OF STAMP STOCK IN EXCESS OF \$1,000 BY A WINDOW CLERK**

When a commanding officer deems it necessary for a window clerk to retain stamp stock in excess of \$1,000, a letter of authorization must be prepared and signed by the commanding officer and filed in the clerks service record and the MPO files (see figure 8-2).

*Q8-15. The total amount of a command's fixed credit depends upon the number of persons assigned. As a general rule, what minimum dollar amount is used per person to establish the command's fixed credit?*

*Q8-16. What instruction lists the procedures for establishing fixed credits in MPOs?*

*Q8-17. Authorizations to retain more than \$1,000 in a clerk's individual fixed credit account must be approved by what authority?*

Now turn to appendix 1 to check your answers.

### **REPLENISHMENT**

---

**Learning Objective:** *Recognize the procedures for replenishing a fixed credit account.*

---

For replenishment purposes, the amount of fixed credit of your Navy MPO is divided into two groups:

- The **PORTION** of the individual fixed credit in your custody and in the custody of each window clerk
- The **TOTAL** of the fixed credit of your MPO

Stamp stock for each of these two groups is replenished as described below.

### **INDIVIDUAL FIXED CREDIT**

The portion of individual fixed credit in the custody of window clerks is replenished weekly. COPEs are also required to order stamp stock weekly or when accumulated cash exceeds 25 percent of their fixed credit. This is done by requisitioning stamps

with the accumulated cash from the appropriate source of supply, clerks order from the COPE, and the COPE orders from the reserve custodian. For example, a window clerk would submit a PS Form 17 in duplicate to the COPE once a week listing the desired amount and denomination of stamps in exchange for cash. In the case of a COPE's account, the exchange of cash for stamps is accomplished by submitting a completed PS Form 17 in duplicate to the reserve custodian.

### **ACTIVITY FIXED CREDIT**

Replenishment of part of the total fixed credit of your MPO is more detailed than the daily method of replenishing individual fixed credits mentioned above. Again, replenishment is required before the accumulated cash amounts to 25 percent of the total fixed credit carried or at least monthly, whichever occurs first. For example, assume the total fixed credit amounts to \$5,000 for your MPO. The COPE is holding a \$2,000 stamp account, while the reserve custodian is holding the other \$3,000. A requisition for replenishment should be processed before the reserve custodian has accumulated a total of \$750 in cash or at least monthly.

To determine the amount of stock needed, consider the facilities for the protection of the stock, normal stock requirements, and the amount of time required to have a requisition returned. If your ship is scheduled for an extended deployment, submit your replenishment requisition at least 4 weeks before getting underway to ensure that the stock is received before your departure. This 4-week lead-time also coincides with the request for an increase in fixed credit, which is occasionally needed before deployment. Increase of fixed credit is covered later in this chapter.

### **REPLENISHMENT GUIDELINES**

Experience will soon teach you, the COPE, which stamps are in heavy demand. MPOs in deployed ships and at overseas activities normally use higher value stamps than those ships that are in their homeports. Also you should consider the increased mailing before holidays, particularly Mother's Day, Father's Day, Easter, Christmas, and Valentine's Day. Anticipate your needs, and always keep a supply of the best sellers and commemoratives on hand.

Your first step in ordering is to determine how much cash is available to replenish your stamp stock.

Then, determine which denominations are in lowest supply.

When you determine the quantities to be ordered, remember that most of the stamps you handle are issued in sheets of 20, 50, or 100. In all cases adjust the amount of the requisition, whenever possible, to permit ordering stamps in at least full sheets. When requisitioning stamps, refer to the DMM or the Postal Bulletin for proper denominations and quantity.

## STAMP REQUISITIONS

---

**Learning Objective:** *Recognize the procedures for completing stamp requisitions.*

---

Requisitions are prepared and submitted on PS Form 17 in an original and three copies that will contain the following information:

Block 1: The requisition number (beginning at the fiscal year [Oct 1]), the check number and the amount of the check.

Block 2: Your command's complete mailing address.

Block 3: An impression of the APDS. The APDS must NOT be photocopied.

Block 4: The COPE or other submitter's signature. Do NOT photocopy signature. To verify the requisition, the reserve custodian initials here.

Block 5: Left blank unless returning stamps.

Block 6: Left blank unless returning stamps.

Block 7: Check appropriate block. NOTE: if returning damaged or old stock and ordering new stamps, you should use two separate requisitions.

Block 8: Information concerning the stamps you are ordering or returning in the appropriate columns.

Block 9: This block is left blank unless returning stamps.

Block 10: The total amount of stamps ordered.

Block 11: Signature of the reserve custodian and the date when the stamp requisition was received.

Block 12: Signature of the COPE and the date when the stamp requisition was received.

After you have completed the requisition, always recheck to make certain that the entries are aligned, that the multiplication is correct, and that the values have been correctly totaled. You should also verify that the U.S. Treasury check or no-fee money order(s)

contain the appropriate dollar value and are made payable to the Postmaster San Francisco (Postmaster New York when ordering from PFOs located in Bahrain, Sigonella, IT, Rota, SP, or London UK). Always prepare the remittance for dispatch in the presence of a witness. Ask the witness to check all entries before signing the requisition. With the witness still present, enclose the original and one copy of the PS Form 17 and the check or no-fee money order in a USPS indicia envelope, seal it, and send via First-Class mail. NOTE, when ordering from the PFO located in Rota, SP, send remittance via Registered or Certified mail. Attach the mailing receipt to the MPO file copy.

Distribution of PS Form 17:

Original and copy 1 to source of supply

Copy 2 to MPO file

Copy 3 to reserve custodian's file

## RECEIPT OF STOCK

---

**Learning Objective:** *Recall procedures to follow when receiving stamp requisitions.*

---

The NPFO or PFO who fills the requisition will return the duplicate copy and postage stamp stock by registered mail to your MPO. As soon as possible after receipt, the COPE must deliver the requisition UNOPENED to the reserve custodian. The reserve custodian must sign for the incoming requisition on PS Form 3883. The COPE and the reserve custodian must open the requisition. Care must be taken that postage stock is not discarded with the wrappings. After the reserve custodian has received all the items and the COPE has witnessed the receipt, the COPE compares the amount listed on the duplicate copy of PS Form 17 with the retained copy of the requisition in the post office files, and makes required changes, if any.

If found to be correct, the reserve custodian signs and dates block 11 and the COPE signs and dates block 12.

After verification and completion of the above entries on the duplicate PS Form 17, file in the MPO files for 2 years, and destroy the reserve custodian and MPO file copies of the form.

The next step is to record receipt of the stamp stock. PS Form 3295, Daily Record of Stamps, Stamped Paper, and Nonpostal Stamps on Hand (see figure 8-4) is used for this purpose. To maintain an accurate inventory of the main stock, a separate form is



used for each denomination and type of stock (both the COPE and the reserve custodian should maintain a copy). Complete the form in the following manner:

Block 1: Enter the value of stamps per book or coil.

Block 2: Enter the value of envelopes per thousand.

Block 3: Enter the denomination (i.e., \$.33, \$.50, etc.).

Block 4: Enter the item number.

Block 5: Enter the description of the stamped items (i.e., envelope, book, etc.).

Block 6: Enter the date of the transaction.

Block 7: Enter the total amount of stamps received.

Block 8: If issuing stamps or returning stamps to the source of supply, enter the amount.

Block 9: Enter total amount of stamps remaining on hand.

Block 10: Enter the total dollar amount of the stamps on hand.

PS Form 3295 must be used until both the front and back are full, then a new form must be started. The completed form will be maintained in MPO files.

By proper use of this form, especially in posting the receipt and issuance of stock, the amount of the fixed credit not in the custody of the COPE can easily be determined at anytime. When you replenish your stamp stock from the reserve custodian, compare his or her copy with your copy of PS Form 3295.

If a discrepancy is found when the shipment is received, report the facts immediately to your postal officer and commanding officer. In the event of a shortage in the shipment, notify the source of supply by letter stating the circumstances. The letter should include the name of the person who signed for the requisition, and the name of the person who witnessed the opening of the requisition. A copy of the PS Form 17 must be included as an enclosure. A copy of the letter report should be filed in the post office, and the amount of the discrepancy should be carried as "in transit" pending adjustment. The wrapper of the package, or the shipping case, if envelopes are involved, must be carefully preserved until the matter is adjusted. The commanding officer will notify the Military Postal Service Agency (MPSA) by message of the circumstances.

If an overage is found, you will report the facts in the same manner as a shortage. Only after the incoming stamp requisition has been audited twice and double-checked will you return the overage of stamp

stock with a photocopy of the original PS Form 17 and letter of explanation of the circumstances.

## INCREASING OR DECREASING FIXED CREDITS

---

**Learning Objective:** *Recall the procedures for increasing or decreasing fixed credit accounts.*

---

You should keep sufficient postage stamps available to meet the anticipated needs of your ship or station.

As conditions warrant, request an increase or a decrease of your fixed credit. An increase should be made, for example, before departure on an extended deployment of 3 months or more. If an air group or a Marine detachment is to be embarked, also take this into consideration.

Your fleet, force, and type commanders may also issue supplementary instructions on increasing your stamp stock before deployment, and on decreasing it upon returning from deployment.

Another condition for requesting an increase could be for requesting holiday stamps such as Christmas stamps.

A request for an increase in the fixed credit and reductions thereof should be in multiples of \$500.00.

## INCREASE

A request for an increase in fixed credit is made in letter-form by the commanding officer to the NPFO or PFO as appropriate with a copy to the applicable FLTCINC. The request for additional stamp stock should state the amount of increase desired, the new fixed credit resulting there-from, the reason for the request, and the date by which the additional stamp stock is required (see figure 8-5). As an enclosure to the letter, include PS Form 17 in duplicate, listing the quantities and denominations of stamp stock desired to make up the increase in credit with two PS Form 3369s completed but not signed. Prepare a triplicate of the stamp requisition to be retained in your files.

Upon receipt of the increase, the COPE and reserve custodian should verify that it is correct. Then the COPE signs the enclosed PS Form 3369s, and returns the original to the source of supply. The duplicate copy of PS Form 3369 should be retained in the MPO files and the triplicate copy destroyed. Other procedures upon receipt of this stock are the same as those used when stamp stock is regularly replenished.





/COMMAND LETTER HEAD/

SER 5110

Date:

From: Commanding Officer, USS Underway  
To: Navy Postal Finance Office, 4070 Surface Navy Blvd Ste 3,  
San Diego CA 92136-5287 (Address will be different if sent to a PFO)

Subj: INCREASE IN FIXED STAMP CREDIT

Ref: (a) DOD 4525.6-M Vol. 1, Chap 5, Paragraph 502.3.C

Encl: (1) PS Form 17 (in duplicate)  
(2) PS Form 3369 (in duplicate)

1. To ensure adequate financial service for an extended deployment, it is requested the fixed credit for USS \_\_\_\_\_, office ID number (UIC + 9) \_\_\_\_\_, be increased by (multiples of \$500.00) \_\_\_\_\_, as indicated in enclosures (1) and (2), which will result in a new fixed credit of \$ \_\_\_\_\_. The additional stamp stock requested is required to be received on board no later than \_\_\_\_\_.

/s/  
W.T. Door

Copy to:  
FLTCINC  
Post office files

Figure 8-5.—An example of a letter to increase a fixed credit account.

The reserve custodian must also sign a PS Form 3369 prepared for the increase in stamp stock.

### DECREASE

When the need for the increased credit no longer exists, the fixed stamp credit should be reduced. This reduction is accomplished by preparing a fixed credit decrease letter in the same basic format as an increase letter. Determine the amount of the decrease in multiples of \$500.00.

Fixed credit reduction can be accomplished in three different ways:

- By submitting a U.S. Treasury check or no-fee money order made payable to the appropriate

accountable postmaster, mailed to the NPFO or PFO with the portion of the credit that is no longer needed. Enclose two signed copies of PS Form 3369 indicating the new fixed credit and the fixed credit decrease letter.

- By returning all stamps. When stamp stock is returned to reduce fixed credit, follow the basic procedures for returning stamps (see next paragraph). Itemize all returned stamps on a PS Form 17, prepare a duplicate PS Form 3369 (signed) reflecting the amount of the new fixed credit and enclose the decrease letter. Send to NPFO or PFO by registered mail.
- By submitting a U.S. Treasury check or no-fee money order and returning stamp stock. When

reduction of fixed credit is accomplished in this manner, follow the procedures for returning all stamps. Include the check or no-fee money order with the PS Form 17, signed PS Form 3369, and the stamp stock decrease letter. Ensure that the check or money order and the stamps combined equal the amount of the desired decrease.

## EXCHANGING DAMAGED STAMP STOCK

---

**Learning Objective:** *Recall the procedures for processing damaged stamps for return to the source of supply.*

---

Do not sell damaged stamps or stationery to your patrons. Always ensure, before delivering stamps to customers that they are free from damage. If stamps become damaged while in the customer's possession, they can be exchanged by the customer; however, the exchange is always made in stamps, NEVER IN CASH. The exchange will be an equal value of stamps of the same denomination. Stamps presented for exchange must be in substantially whole condition with the denomination evident.

Occasionally you will receive damaged stamps in a stamp requisition. Sometimes a clerk will damage stamps while separating a sheet, or when tearing a stamp from the sheet. Do not sell damaged stamps to the public. Return all damaged stock to the source of supply for exchange (COPE, NPFO, PFO).

Prepare PS Form 17 in duplicate (see figure 8-3) to return stock because of damage or for redemption. Prepare the form exactly as if you were making a regular requisition, except mark the Return stock box number 4.

The stamps you return are part of your fixed credit; therefore, you must requisition replacement stamps equal in value to the amount of the damaged stamps you are returning. You have the option to replace the damaged stamps with stamps of the same denomination or substitute them with a different denomination.

When you return stock on PS Form 17, you must also prepare a separate PS Form 17 requisitioning stamps (check clerk order box in block 7).

Submit requisitions for exchange of stamp stock separately from regular requisitions. The COPE, NPFO, or PFO will replace the stamp stock and return it to you like an ordinary requisition.

Remember, when returning stamps for exchange, unless returning to the COPE, the stamps must be returned by registered mail.

*Q8-18. Window finance clerks should exchange cash for stamps from the COPE at least how often?*

*Q8-19. The total amount of your window stamp stock is \$1,000. Replenishment is required when your cash exceeds what amount?*

*Q8-20. A COPE should exchange cash for stamps from the source of supply at least how often?*

*Q8-21. Stamp requisitions are prepared and submitted on what PS form?*

*Q8-22. Stamp stock is recorded and inventoried on what PS form?*

*Q8-23. When increasing or decreasing your command's fixed credit, it should be in multiples of what amount?*

Now turn to appendix I to check your answers.

## POSTAGE METERS

---

**Learning Objective:** *Recall the procedures for operating, safeguarding, and accounting for postage meters.*

---

If you are assigned to a large command such as an aircraft carrier or large shore activity overseas, your duties as a finance clerk may require you to operate a postage meter machine. Postage meters are furnished by the USPS to military post offices to provide a means of selling postage without the use of postage stamps.

### WHAT IS A POSTAGE METER

A postage meter machine consists of two main parts: a postage meter head (see figure 8-6) and a meter base (see figure 8-7). While there are several different makes and designs of postage meters, the operating procedures are basically the same. The postage meter and the meter base are separate pieces of equipment, but can only be operated when used together and engaged by the meter key. The postage meter is the smaller of the two pieces and is designed to fit on the meter base (see figure 8-8). The meter base holds the ink, water, paper tape, and operates the meter. Only red ink and tape issued by the USPS should be used in the meter base. When operated, the postage meter makes an imprint on a gummed tape and records the amount of postage sold, in dollars and cents. You can print any denomination of postage. However, do not issue

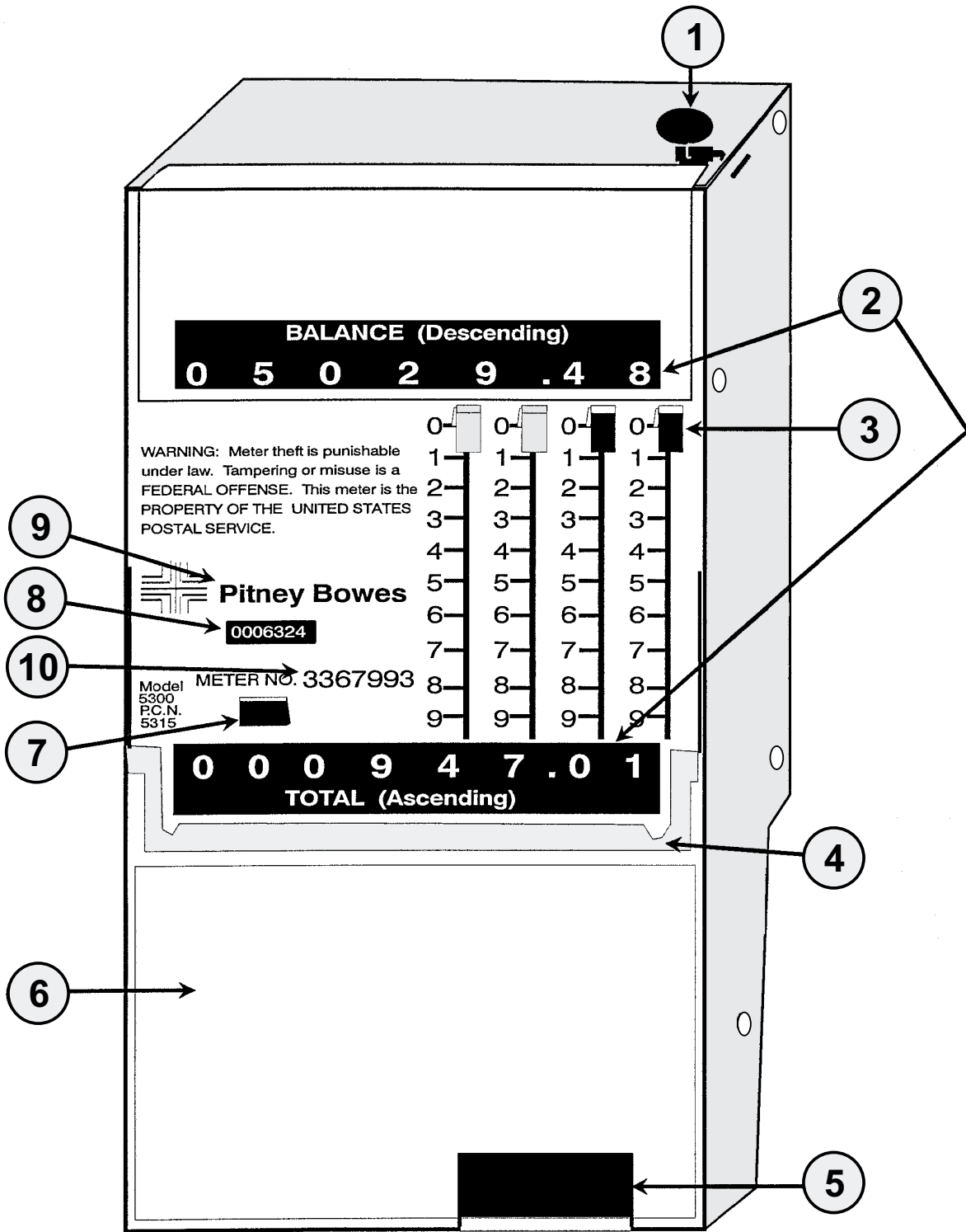

PCf0806

Figure 8-6.—An example of a postage meter head.

tapes showing .00 in the indicia or for less than 5 cents. Meters do not print a single tape for more than \$99.99.

The following are parts of the meter head:

Part 1: LEAD/PLASTIC SEAL. COPEs use this seal to secure the meter head after setting (adding) postage

to the meter. (The seal is NOT actually a part of the meter head, but clerks should be aware that the seal must be present and secure before accepting or using the meter.)

Part 2: RECORDING MECHANISM. The postage meter incorporates two visible postage counting

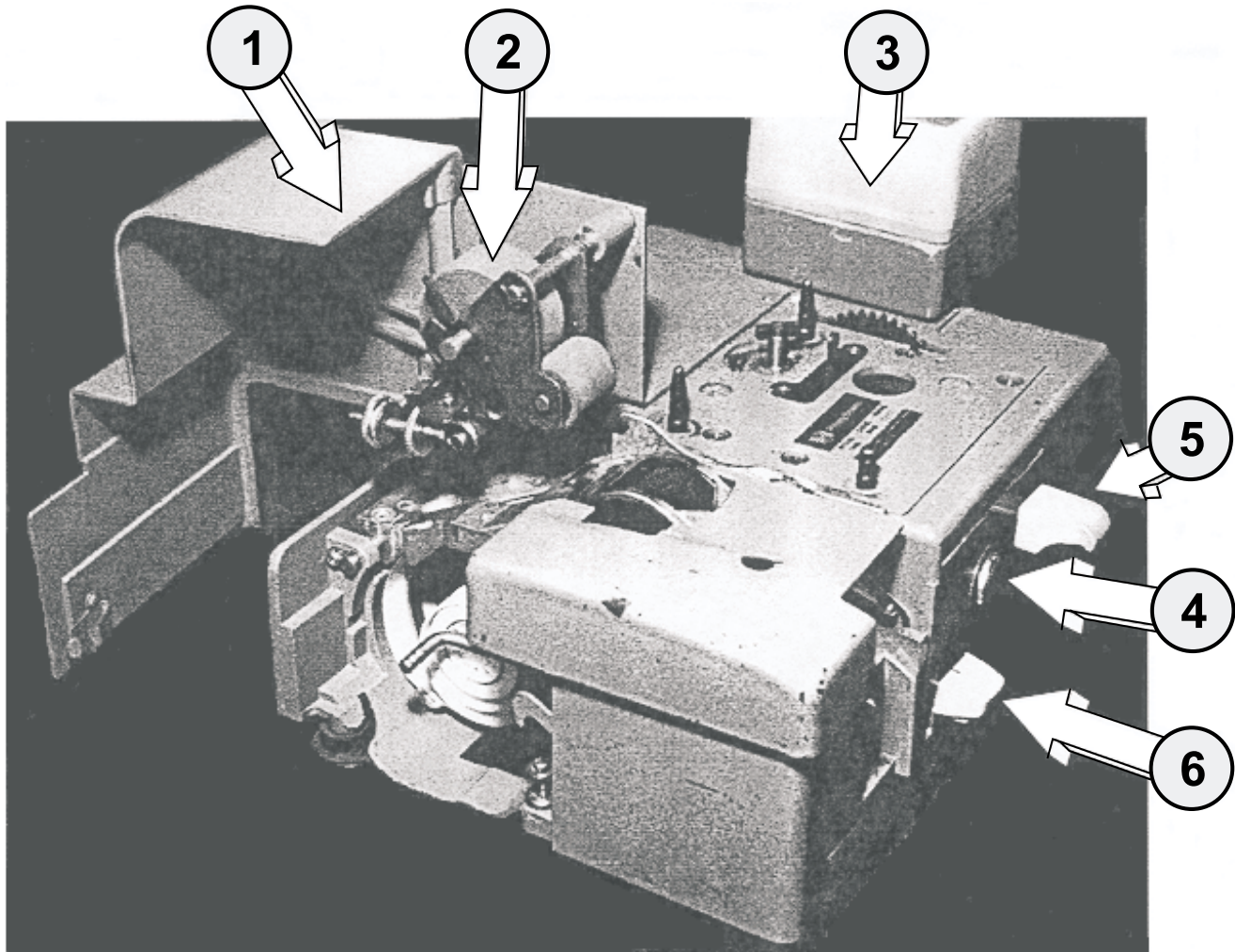

PCf0807

**Figure 8-7.—An example of a postage meter base.**

registers, Credit Balance (Descending) and Cumulative Total (Ascending). The ascending register shows the total amount of postage used and advances each time a tape is printed. The descending register indicates the balance of postage credit remaining in the meter and is reduced each time a tape is printed. Use these numbers at the beginning and ending of each business day to compute the amount of postage sold.

**Part 3: SETTING LEVERS.** These levers are used to set the amount of postage. The two “Black” levers are used to make meter tapes for \$.99 or less and the “Red” levers are used for \$1.00 up to \$99.99.

**Part 4: METER LIFTING HANDLE.** Use this handle to lift the meter head off the meter base or to remove it from the meter head case.

**Part 5: INDICATOR WINDOW.** Exact amount of postage that will be printed can be read easily in this

display window. After you have selected a postage value, check that the correct amount will be printed by a quick glance at the figures in the window.

**Part 6: DATER COVER.** The dater cover opens to expose the date changing mechanisms. The meter incorporates a safety device that permits operation only when the dater cover is completely closed. If the cover is left open when the tape trip lever is depressed, a safety device will lock the machine and prevent it from starting the operating cycle.

**Part 7: HIGH DENOMINATION BUTTON.** When you select postage of \$1.00 or more, hold this red button down while you depress the tape trip lever. This feature prevents the unintentional printing of high-value tapes.

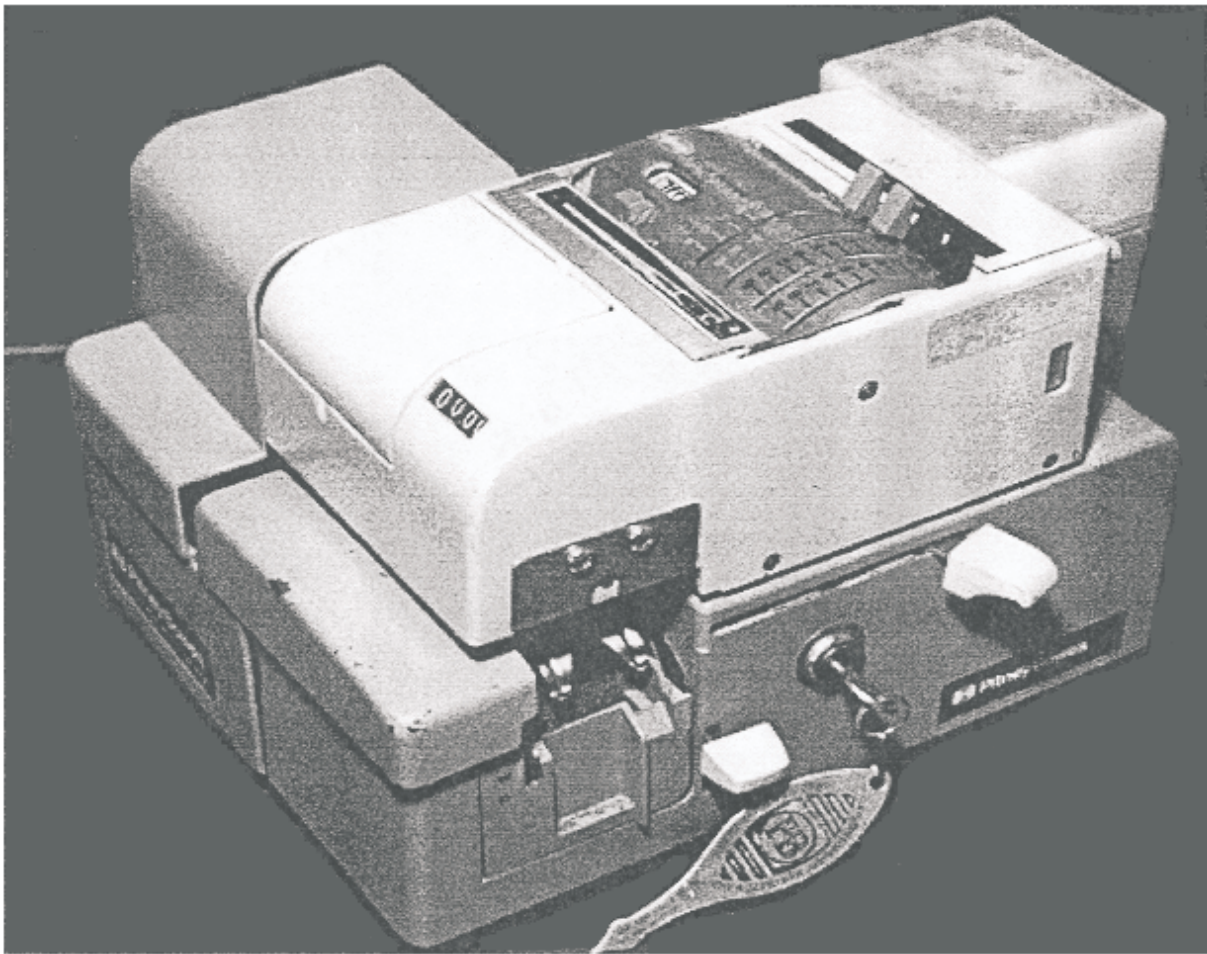

PCf0808

**Figure 8-8.** An example of a meter head engaged to the meter base.

**Part 8: COUNTER WINDOW.** This counter advances once each time you produce a meter tape. This counter cannot be reset manually.

**Part 9: METER MANUFACTURER.** The manufacturer's logo and name are engraved on the meter.

**Part 10: SERIAL NUMBER.** The meter head serial number is also engraved on the meter and is usually located above the high denomination button. Each meter head has its own unique number. Each time a meter tape is produced, this serial number is printed on the tape indicating which meter produced it.

The following are parts of the meter base:

**Part 1: TAPE AND INKER COMPARTMENT COVER.** This cover protects the ink rollers and meter tape from being damaged. By grasping the upper-left portion of the machine and pulling it out and to the left, both the tape and inker compartments are exposed.

**Part 2: INKER.** The inker assembly consists of two absorbent rollers that are mounted on a metal bracket.

The larger of these rollers is saturated when new, with enough ink to produce approximately 15,000 tape stamps.

**Part 3: WATER CONTAINER.** This container is used to moisten tapes when the deflector switch is in the "WET" position.

**Part 4: CUSTOMER'S LOCK.** This is a cylinder lock used for locking the meter on the machine and to lock the machine against operation. To place the machine on the "lock" position, shift the operating lever (Part 5) to the center position between OPERATE and REMOVE, then turn the key clockwise one-half turn and remove the key.

**Part 5: OPERATING LEVER.** This lever can be set at one of three positions, REMOVE (forward position), LOCK (center position) or OPERATE (rear position). The operating lever engages the meter to the machine when it is moved to the extreme rear position. This lever must be moved fully forward when you wish to install or remove the meter or when you wish to engage the meter when it has been secured.

Part 6: TAPE LEVER. This lever works only on the "OPERATE" position. Depressing this lever will activate the printing mechanisms and causes one printed stamp to be delivered at the right side of the machine.

### METER REGISTERS

Each postage meter has two registers. One is called the ascending register and the other the descending register (see figure 8-6, part 2). When postage is printed, the descending register subtracts, or goes down. At the same time the ascending register adds, or goes up. So the descending register will always show you the amount of postage in dollars and cents remaining on the meter. The ascending register will show the total amount of postage sold.

Example: Present meter readings

Descending  
502948

Ascending  
94701

If you sold postage in the amount of \$.48, the meter readings would look like this:

Descending  
502900

Ascending  
94749

Using these same register readings, how much postage is remaining on the meter? How much postage

has been sold? You should have answered \$5,029.00 total postage remaining and \$947.49 for the total postage sold. To print the desired amount of postage, set the amount keys on the meter (see figure 8-6, part 3) to the appropriate numbers.

### SAFEGUARDING POSTAGE METERS

Each postage meter is accountable equipment and is controlled by one person, usually the COPE. (Remember postage meters are only at large MPOs.) However, custody of a meter may be assigned to another person if it is not feasible for the COPE to have custody. Remember, each postage meter has a meter number imprinted on it (see figure 8-6, part 8). The meter custodian will issue the postage meter and key at the beginning of each business day to the operating clerk and will take custody of it at the end of the business day. The key is used to lock the meter whenever the meter is not under personal supervision. While the meter is in the meter operator's custody, the operator is responsible for all postage printed and for locking the machine and safeguarding the meter operating key during temporary absences.

### ISSUING THE METER

PS Form 3602-PO, Postage Collected Through Post Office Meter (see figure 8-9) is used to record daily meter register readings. These forms are issued in pads of 100 forms in triplicate. The forms are serially numbered and are accountable. Each set of three forms has the same number. The meter custodian should retain these forms.

Figure 8-9.—An example of a PS Form 3602-PO set.

Each day the meter is to be used, the meter custodian should enter the following information on PS Form 3602-PO (see figure 8-10):

Block 1: UNIT OR STATION. Enter the station where the meter is assigned. For example, FPO AE 09561-0001.

Block 2: METER MFR. Enter the manufacturer's name. For example, Pitney-Bowes. Abbreviations such as "PB" are permitted.

Block 3: METER NO. Enter the meter head serial number located just above the high denomination button.

Block 4: DATE. Enter the current date.

Block 5: DESCENDING REGISTER BEGINNING. Obtain this number from the meter head's "BALANCE (Descending)" register reading. To avoid mistakes on PS Form 3602-PO, write the numbers from right to left and exclude preceding zeroes. For example, if the register window shows "01020.98", first write "8," then

**BALANCE (Descending)**  
0 1 0 2 0 . 9 8

WARNING: Meter theft is punishable under law. Tampering or misuse is a FEDERAL OFFENSE. This meter is the PROPERTY OF THE UNITED STATES POSTAL SERVICE.

**Pitney Bowes**  
0006324

Model 5300 P.C.N. 5315  
METER NO. 2753812

**TOTAL (Ascending)**  
0 0 0 3 4 7 . 0 2

**1** FPO AE 09561-0001 (Unit or Station)  
**2** ORIGINAL PB (Meter Mfr.)  
**3** 2753812 (Meter No.)  
**4** 7 DEC 98 (Date)

This is to certify that the readings of the registers were as follows at the beginning and end of this day:

Descending register beginning → 1 0 2 0 9 8 **5** Ascending register end  
Descending register end Ascending register beginning

RECEIVED FOR POSTAGE as determined by the register readings

ABS **7** (Meter Operator) JRD **8** (Supervisor)

**6** 77 3 4 7 0 2

**REPORT OF METER SETTING**  
(Fill in the following only when meter is reset)

Ascending register readings . . . . .  
Descending register readings before setting . . . . .  
Number of units added . . . . .  
Descending register after setting . . . . .

PS Form 3602-PO Jan. 1983 Meter set by . . . . .

Figure 8-10.—An example of start of the day entries on PS Form 3602-PO.

PCF0810

“9,” “0,” “2,” “0,” and “1”. DO NOT skip any box or write decimal periods.

Block 6: ASCENDING REGISTER BEGINNING. Obtain this number from the meter head’s “TOTAL (Ascending)” register reading and enter it in the same manner as explained above for descending.

Block 7: METER OPERATOR. Clerk accepting custody of meter enters initials on all three copies.

Block 8: SUPERVISOR. Meter custodian enters initials on all three copies.

After the required information has been entered on PS Form 3602-PO, the meter custodian will issue the operating lever locking key, the triplicate copy of PS Form 3602-PO, and release the meter to the meter operator.

### OPERATING THE POSTAGE METER

Now that you have the meter head in your possession, you have to engage it to the meter base. But before you can start producing meter tapes, make sure that

- the power plug is securely inserted into a grounded electrical outlet,
- the operating lever is positioned all the way to the rear (OPERATE position),
- the setting levers are positioned all the way up (indicator window should show 00.00 amount), and

- the date has been set correctly and dater cover is closed.

To change the date, raise the dater cover and move the plastic wheels so that the proper date is in line with the date index (metal ridge). The day and month can be changed by turning the proper plastic setting wheels; the plastic wheel at the left of the date index turns the day units wheel at the right, and the 10th, 20th, and 30th of the month is set by moving the notched wheel located at the right of the month wheel. The year can be changed by turning the individual metal printing wheels (see figure 8-11).

After changing the date, run a “zero” tape by depressing the tape trip lever and verify if the date is correct. Also check the ink tone on the tape. If the imprint is light or uneven, add ink to the ink roller. DO NOT over ink the roller or smudged impressions may occur.

Now that the meter is ready, follow the steps given below to produce meter tapes.

- Set the amount by sliding the SETTING LEVERS up or down to the correct amount. Verify that the INDICATOR WINDOW displays the selected amount (see figure 8-12).
- For amounts \$.99 or less, depress the TAPE TRIP LEVER (see figure 8-13). For amounts \$1.00 and up, first press and hold down the HIGH DENOMINATION BUTTON, then depress the TAPE TRIP LEVER (see figure 8-14).

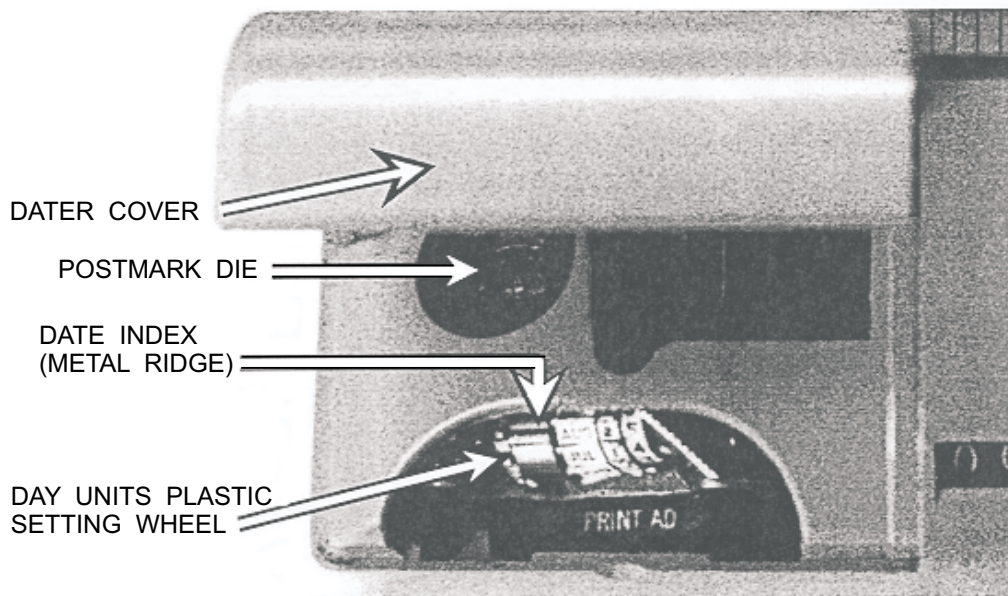

PCF0811

Figure 8-11.—An example of a postage meter print mechanism.



- Remove the meter stamp from the meter machine. Verify the amount and place the meter stamp in the upper-right corner of the article. Note: When customers use name labels or tags to address an article, the meter stamp must be applied in the upper-right corner of the label or tag (see figure 8-15).

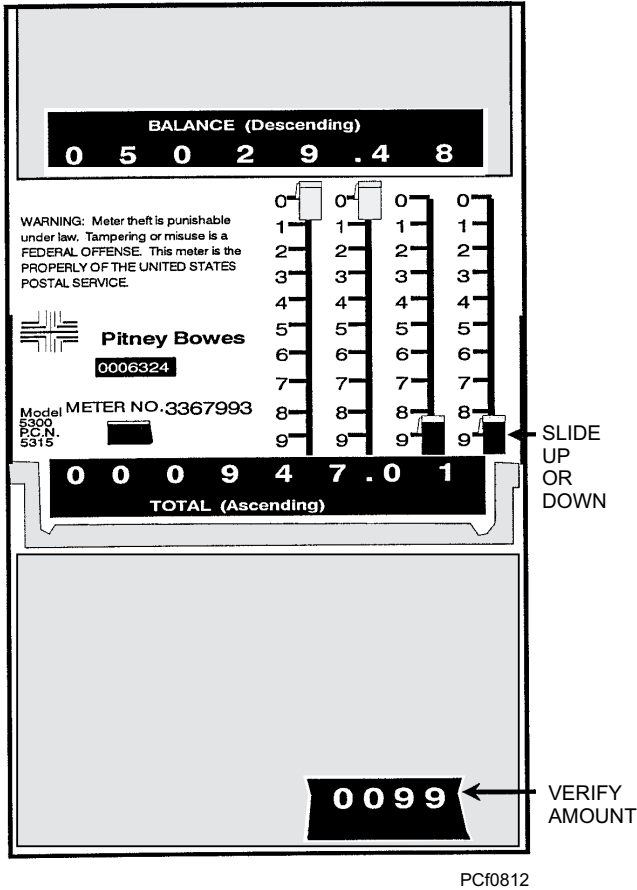

Figure 8-12. —Setting postage amount.

Occasionally, an operating clerk may print a postage meter tape for the wrong amount of postage. If the amount of the tape is lower than the total required, use the tape and make a new tape for the difference. If the tape exceeds the amount required, print a new meter tape. The clerk retains all unused tapes and submits them to the meter custodian as part of the remittance at the end of the business day.

Note: During the business day, another patron may present an article for mailing requiring enough postage and fees for the clerk to use the unused tape from earlier in the day.

### ABSENCE OF OPERATOR

During short absences from your window, lock the base-operating lever. During longer absences, such as for lunch, you may release the meter to another clerk for operation. If you release the meter to another clerk, you must (see figure 8-16):

- Record the descending and ascending register readings on the reverse of the triplicate copy of PS Form 3602-PO. Both you and the relieving clerk will initial the readings.

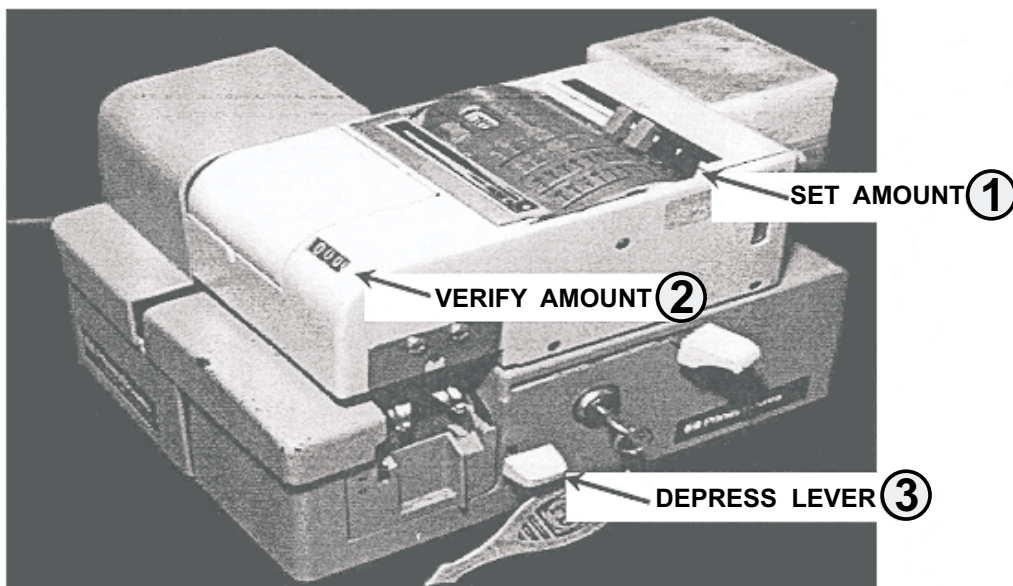
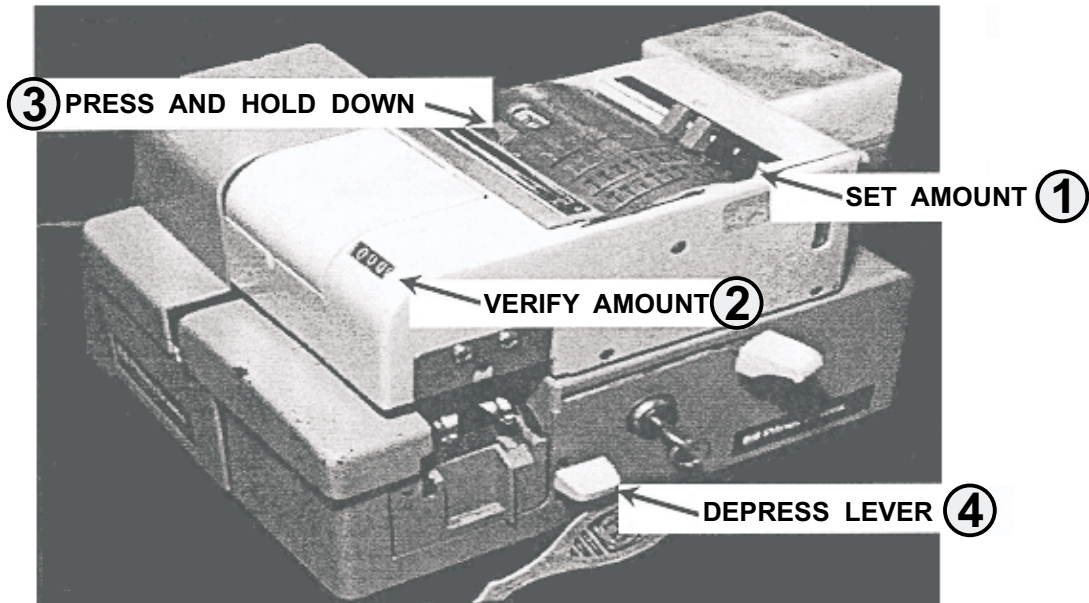
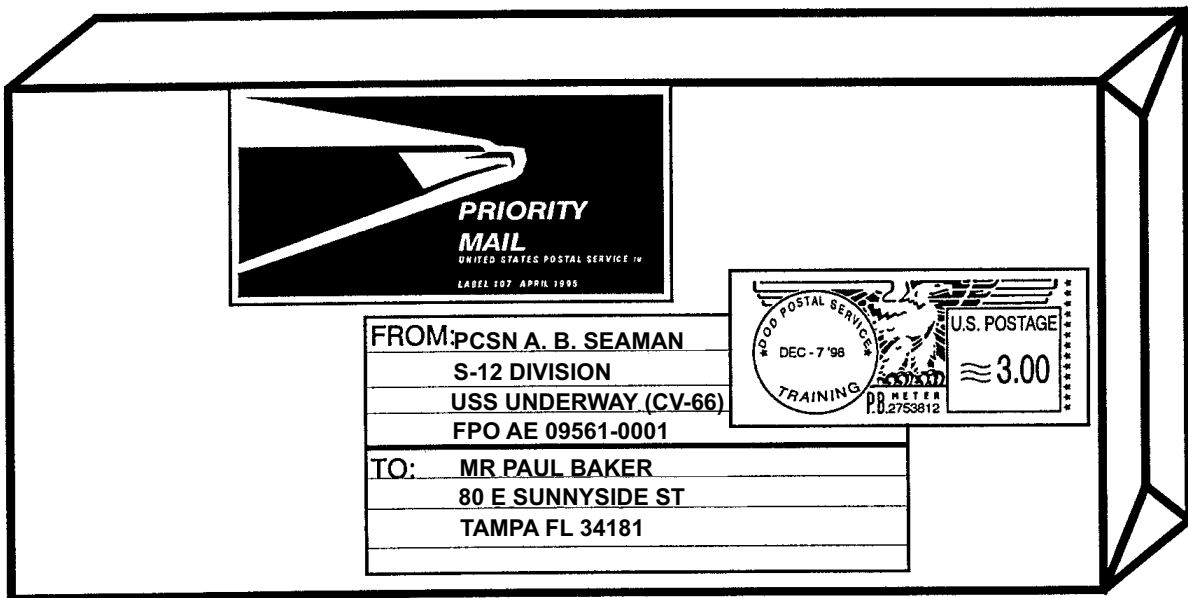

Figure 8-13.—An example of procedures for printing \$.99 or less meter stamp.



PCf0814

Figure 8-14.—An example of procedures for printing \$1.00 or more meter stamp.



PCf0815

Figure 8-15.—An example of proper placement of a meter stamp on articles with address labels or tags.

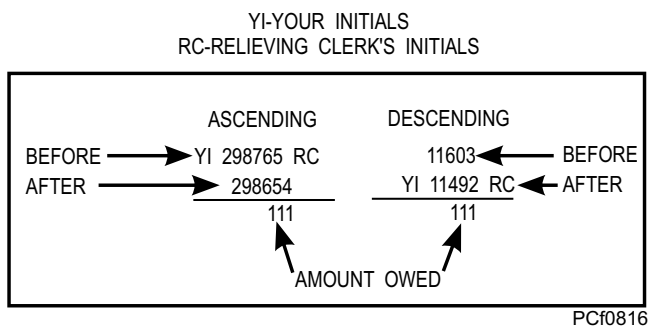

PCf0816

Figure 8-16.—An example of meter register readings recorded on the reverse of PS Form 3602-PO.

- Obtain a receipt on PS Form 1096, Cash Receipt, for any cash you may turn over to the substitute clerk for change making.
- Record the descending and ascending readings again, when you return.
- Subtract the two register readings to determine the amount of meter sales for which the substitute operator is responsible.
- Collect funds for meter sales and the change fund, if any was turned over to the substitute

operator. These meter funds will be included with the remittance at the end of the business day.

- Give the substitute clerk a receipt for meter funds collected using PS Form 1096.

### RETURNING METERS AT THE CLOSE OF DAILY BUSINESS

At the close of the day's business, you determine how much metered postage you sold by subtracting the "DESCENDING REGISTER END" from the "DESCENDING REGISTER BEGINNING," and the "ASCENDING REGISTER BEGINNING" from the "ASCENDING REGISTER END." The two ending amounts MUST be equal and these figures reflect the amount of funds you have to submit to the meter custodian.

When meter operators have unused meter tapes at the end of a day's business, the amount of the tape(s) is deducted from the funds. For example: If a clerk does \$500.00 in postage meter business and has two unused meter tapes totaling \$15.00, the clerk gives the meter custodian \$485.00 in funds and the two tapes valued at \$15.00 equaling the total sales of \$500.00 (see figure 8-17).

- The meter operator must also complete a PS Form 3533 (Application and Voucher for Refund

of Postage and Fees) for submission with the spoiled meter tapes. The COPE, meter operator, and a certifying employee (Postal Officer) must sign this form.

- If a postage meter fails to print a meter tape, and the amount is registered on the ascending and descending counters, submit a letter of explanation, signed by the postal officer, with a completed PS Form 3533. The COPE, meter operator, and postal officer must sign the PS Form 3533.

The following items will be turned over to the meter custodian:

- Postage meter head
- Meter operating lever key
- Funds for meter tapes sold
- Unused meter tapes (if any)
- Triplicate copy of PS Form 3602-PO

The meter custodian will reinsert the triplicate copy back into the correct form set of the PS Form 3602-PO book. Once in place, the custodian will record the ending ascending and descending register readings. The difference between these two numbers is the amount the meter custodian is going to collect from you. It is your responsibility to verify these

**\$500.00 TOTAL SALES**  
**- \$15.00 UNUSED METER TAPES**  

---

**\$485.00 AMOUNT OF FUNDS TO TURN IN TO THE METER CUSTODIAN**

ORIGINAL

**FPO AE 07561-0001 PB 2753812 7DEC98**

(Unit or Station) (Meter Mfr.) (Meter No.) (Date)

This is to certify that the readings of the registers were as follows at the beginning and end of this day: 77

Descending register beginning	102098	Ascending register end	84702
Descending register end	52098	Ascending register beginning	34702
RECEIVED FOR POSTAGE as determined by the register readings	50000		50000

ABSABLE B SEAMAN *Ab. B. Seaman* PCSN JRD JOHN R. DOE *John R. Doe* PC1  
(Meter Operator) (Supervisor)

REPORT OF METER SETTING  
(Fill in the following only when meter is reset)

Ascending register readings			
Descending register readings before setting			
Number of units added			
Descending register after setting			

PS Form 3602-PO Jan. 1983 Meter set by: .....

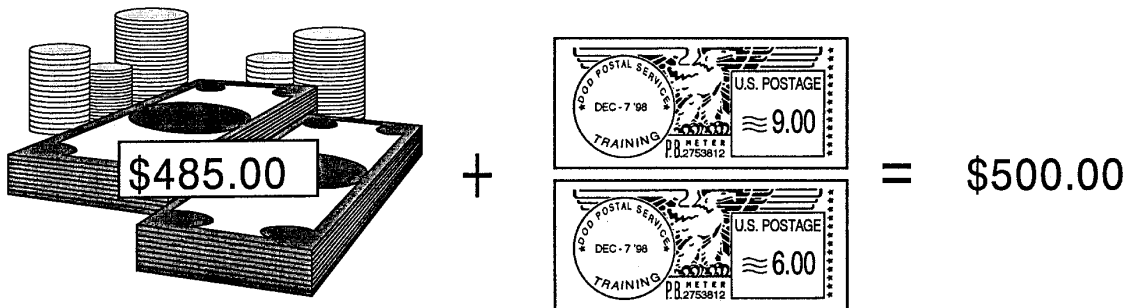

Figure 8-17.—Calculating the amount of meter funds to be turned in at the close of daily business.

PCF0817

figures for accuracy. If accurate, then you must enter the following information next to your initials:

- Printed name
- Rank
- Signature

The meter custodian will do the same on the "SUPERVISOR" line (see figure 8-17). At that time the meter custodian will return the triplicate copy of PS Form 3602-PO to you, along with a PS Form 1096.

Read the following to learn what information must be entered on PS Form 3602-PO to complete it (see figure 8-18):

Block 1: DESCENDING REGISTER END. Obtain this number from the meter head's "BALANCE (Descending)" register reading. To avoid mistakes on PS Form 3602-PO, write the numbers from right to left and exclude preceding zeroes. Do NOT skip any box or write decimal periods.

Block 2: ASCENDING REGISTER END. Obtain this number from the meter head's "TOTAL (Ascending)"

**BALANCE (Descending)**  
0 0 5 2 0 . 9 8

WARNING: Meter theft is punishable under law. Tampering or misuse is a FEDERAL OFFENSE. This meter is the PROPERTY OF THE UNITED STATES POSTAL SERVICE.

**Pitney Bowes**  
0006324

Model 5300  
P.C.N. 5315  
METER NO. 2753812

**TOTAL (Ascending)**  
0 0 0 8 4 7 . 0 2

**ORIGINAL**

FPO AE 09561-0001 PB 2753812 7 DEC 98  
(Unit or Station) (Meter Mfr.) (Meter No.) (Date)

This is to certify that the readings of the registers were as follows at the beginning and end of this day:

Descending register beginning	1 0 2 0 9 8	Ascending register end	7 7
Descending register end	5 2 0 9 8	Ascending register beginning	8 4 7 0 2
RECEIVED FOR POSTAGE as determined by the register readings	\$ 5 0 0 0 0		3 4 7 0 2
			5 0 0 0 0

ABS ABLE B. SEAMAN *Ab. B. Seaman* PCSN (Meter Operator) JRD JOHN R. DOE *John R. Doe* PC1 (Supervisor)

**REPORT OF METER SETTING**  
(Fill in the following only when meter is reset)

Ascending register readings	
Descending register readings before setting	
Number of units added	
Descending register after setting	

PS Form 3602-PO Jan. 1983 Meter set by \_\_\_\_\_

Figure 8-18.—Completion of PS Form 3602-PO at the close of the business day.

PCf0818

register reading and enter it in the same manner as explained above.

Block 3: RECEIVED FOR POSTAGE. This is the total of daily business conducted. This is obtained by subtracting the “DESCENDING REGISTER END” from the “DESCENDING REGISTER BEGINNING” and subtracting “ASCENDING REGISTER BEGINNING” from the “ASCENDING REGISTER END.” These two amounts MUST be equal.

Block 4: METER OPERATOR. The meter operator prints his or her name and rank, and signs next to his or her initials.

Block 5: SUPERVISOR. The meter custodian prints his or her name and rank, and signs next to his or her initials.

### **DEFECTIVE POSTAGE METER MACHINES**

When a postage meter becomes defective, attempts to repair the meter locally are NOT authorized. The postage meter must be withdrawn from service and sent to the servicing JMPA for repair or replacement. If the meter base portion becomes defective, it can be repaired locally and should not be returned. If the meter base cannot be repaired locally, then return the meter base to the servicing JMPA.

Use of a postage meter is easy and convenient, and will expedite window transactions for the convenience of postal patrons and postal clerks.

- Q8-24. *What are the two main parts of the postage meter machine?*
- Q8-25. *A postage meter tape can be made out for what maximum amount?*
- Q8-26. *Each postage meter has two registers. Name them.*
- Q8-27. *What PS form is used to record daily meter register readings?*
- Q8-28. *What is the purpose of the postage meter key?*
- Q8-29. *When postage meter heads become defective, the meter operator is not authorized to repair the meter. (True/False)*

Now turn to appendix 1 to check your answers.

### **MONEY ORDERS**

---

**Learning Objective:** *Recall the purpose for providing money order service at Navy MPO's.*

---

Providing money order service is an important part of the overall operation of a military post office. Any post office on board a ship or shore activity that has a disbursing officer assigned should conduct money order business. Conducting money order business is not mandatory at a Navy post office. However, it should be provided as a convenience to personnel and as a service contributing to welfare and morale.

One of your duties as a military postal clerk will be conducting money order business. Money order service means issuing and cashing domestic money orders, remittance of money order funds, and the preparation and submission of money order reports. All information in this section applies to MPOs with a fixed credit account.

### **MONEY ORDER FORMS**

---

**Learning Objective:** *Identify the money order form set, procedures for requisitioning blank money orders, and the security requirements for money orders.*

---

There are two types of money order forms, domestic and international. In this chapter we will discuss the makeup of the domestic money order set, requisitioning, handling, accounting for, and the safeguarding of blank money order forms.

### **THE MONEY ORDER SET**

A money order form set consists of 3 hard copies and 2 carbons, each having a specific purpose (see figure 8-19):

Item 1: The top copy is the money order negotiable document.

Item 2: The Voucher. You will retain this portion to prepare your money order report, which we will discuss later in this chapter.

Item 3: The Customer Receipt. The customer receipt serves as proof of purchase in case of loss or theft of the money order.

Item 4: The 2 carbons are removed along with the voucher before the money order and money order receipt are issued to the customer.

**3 CUSTOMER'S RECEIPT** DO NOT SEND THIS RECEIPT FOR PAYMENT  
KEEP IT FOR YOUR RECORDS

**2 POSTAL M.O. VOUCHER - PLEASE RETURN TO YOUR POST OFFICE IF FOUND**

**1 UNITED STATES POSTAL MONEY ORDER** 15-800  
000

00062061006  
SERIAL NUMBER YEAR,MONTH,DAY POST OFFICE U.S. DOLLARS AND CENTS

PAY TO **NOT NEGOTIABLE** CHECK WRITER **FOR USE AS SAMPLE**  
IMPRINT AREA

ADDRESS FROM

ADDRESS

COD NO. OR USED FOR

**FOR TRAINING PURPOSE ONLY**

⑆ 000008002 ⑆ 00062061006 ⑈

PCf0819

Figure 8-19.—An example of a postal money order form set.

### The Serial Number

Each money order set is assigned an 11-digit number. This number is preprinted in the top left part of the money order set. The first 10 numbers are the serial number used to identify the money order. The 11th digit is used as a check sum number and is NOT part of the actual serial number. The serial number is read by a computer; therefore, the numbers must never be smudged. You should never handle the top third portion of the money order form set.

### Completing the Money Order and Receipt

The purchaser completes the money order and customer's receipt as follows:

- Pay To block—The purchaser of the money order enters the name and address of the person or firm to which the money order is to be paid. The purchaser should enter this information immediately after purchase. A money order that is not completed is the same as a negotiable instrument. It is like cash in the hands of whoever has it.
- From block—The person buying a money order places their name and address in this space.
- COD No. Or Used For block—The purchaser of the money order can indicate for what purpose the money order is to be used. If paying a bill or paying for merchandise ordered, the account number or the type of merchandise ordered may be entered in this space.

### REQUISITIONING BLANK MONEY ORDER FORMS

Blank money order forms should be ordered as needed. If your post office is aboard ship, you must consider several possible scenarios when you place an order. If your ship is on or will be on an extended deployment, you will issue more money orders than if you were in your homeport. Some of the things you should consider are the following:

- What is the ship's operating schedule?
- If a deployment is scheduled, how long will the ship be away from homeport?
- If a deployment is scheduled, will there be an increase in personnel?
- What was the number of money orders sold during the last deployment?
- What is the amount of available storage space on board?

## Requisitioning Frequency

Because of operating schedules, ships must maintain at least a 5-month supply of blank money order forms at all times and shore activities must maintain at least a 3-month supply. All MPOs are restricted to a maximum of a 12-month supply of forms. Once you have determined the number of blank money order forms you will need, you are ready to submit your order. The order must be submitted at least 45 days before the forms are needed. Always monitor blank money order form levels.

## Requisitioning Forms (Normal Requisitions)

Blank money order forms are requisitioned by completing PS Form 17, in triplicate at least 45 days before the minimum supply level is reached. Prepare PS Form 17 (see figure 8-20) as follows:

Block 1: Enter the requisition number. Requisitions are numbered consecutively beginning with the number 01-YY on 01 October each fiscal year.

Block 2: Enter the name and address of the unit.

Block 3: Postmark with the APDS.

Block 4: Clerk submitting requisition signs here.

Block 5: Enter the amount of money orders requested.

The original and duplicate of the requisition form are forwarded to the NPFO or PFO. Note: Even though the same form is used to order stamps and money orders, money order requisition numbers should be kept separate from stamp requisition numbers.

## EMERGENCY REQUISITIONS

Not every situation affecting a ship's operating schedule or postal operations may be covered. Unforeseen events may require your ship to get underway ahead of schedule, or in the case of an overseas activity, a sudden increase in personnel could deplete your stock of money order forms sooner than expected.

When it appears that the supply of blank money order forms on hand will be insufficient to meet demands, an emergency request for blank money order forms can be submitted.

To request emergency blank money order forms, a message should be sent to the appropriate fleet commander-in-chief (FLTCINC) postal officer with an

info copy to MPSA. The message should contain the following information:

- The number of blank money order forms on hand and the number normally used each month
- The number of blank money order forms needed to continue sales until a normal requisition can be obtained
- The nearest MPO where blank money order forms can be obtained, (if known)

The FLTCINC Postal Officer will normally send a reply by message. If the request is approved, an MPO will be assigned to supply the blank money order forms. The forms may be picked up at the supplying MPO or they will be forwarded by registered mail depending on your location. An entry must be made in the Remarks section of the money order report on the first and last day that the forms were used. Each entry must refer to the MPO that provided the forms and the inclusive serial numbers of the forms received.

The MPO that supplies the blank money order forms must submit a letter to the Money Order Division listing the inclusive serial numbers of the forms supplied or shipped. In no case will an opened package (less than 100-form sets) be transferred.

## RECEIPT OF MONEY ORDER FORMS

Each shipment of blank money order forms ordered from the NPFO or PFO is sent by registered mail and should be delivered unopened to the money order custodian. The person receiving the shipment should sign a delivery receipt (PS Form 3883) before verifying that the shipment is correct as ordered.

## Verification of Money Orders

Each shipment of blank money order forms received should be opened and the contents verified as soon as possible after receipt by the reserve custodian and the COPE.

The serial number of the top money order form of each package is visible through the cutout in the chipboard on the top of each sealed package. Remember, each package contains 100 blank money order forms.

It must be assumed that each sealed package contains 100 forms. Sealed packages should not be opened for the purpose of verification. Do not open the sealed packages until you are ready to use the money order forms.



# Stamp Requisition

Postmark

Finance No. - (1) -	Unit ID - - - -	Name of Post Office, Station, or Branch		(3)	
Telephone No. - - - - -	City	State	5-Digit ZIP Code - - - - -		Date Stock Ordered
Signature of Submitter (4)	<p>Prepare an ORIGINAL and ONE COPY of this form. Submit only the ORIGINAL. Keep the COPY for your records. PRINT all information except signatures. Typing is not necessary. Orders cannot be processed without the FINANCE NO. (and UNIT ID., where applicable). Enter one item per line. Use a second form if necessary. ADD UP the <i>Value</i> column and enter the total in the <i>Total Value Ordered</i> box. DATE STAMP the upper right corner on the day stock is ordered.</p> <p><b>NOTE:</b> When an item is out of stock, a similar item of the same denomination, if available, will be substituted unless you indicate otherwise by placing an "X" in the <i>Do Not Substitute</i> block.</p>				
Signature of Shipper					
Signature of Witness					

Type of Requisition (Check One)  1 = Scheduled Order  2 = Clerk Order  3 = Emergency Order  4 = Return Stock

Do Not Substitute	Item No.	Quantity	Value	Denomination and Description
<input type="checkbox"/>	3290	(5)	\$	Domestic Money Orders
<input type="checkbox"/>				Sheet of Stamps (20 – 33¢ stamps)
<input type="checkbox"/>				Stamp Booklet (20 – 33¢ stamps)
<input type="checkbox"/>				Coil of Stamps (100 – 33¢ stamps)
<input type="checkbox"/>				
<input type="checkbox"/>				
<input type="checkbox"/>				
<input type="checkbox"/>				
<input type="checkbox"/>				
<input type="checkbox"/>				
<input type="checkbox"/>				
<input type="checkbox"/>				
<input type="checkbox"/>				
<input type="checkbox"/>				
<input type="checkbox"/>				
<input type="checkbox"/>				
<input type="checkbox"/>				
<input type="checkbox"/>				
<input type="checkbox"/>				
<input type="checkbox"/>				20¢ Cut Stamped Cards
<input type="checkbox"/>				No. 6 3/4 Plain Stamped Envelope
<input type="checkbox"/>				No. 10 Plain Stamped Envelope
<input type="checkbox"/>				No. 6 3/4 Window Stamped Envelope
<input type="checkbox"/>				No. 10 Window Stamped Envelope
Registry Numbers Used		Total Value Ordered		Signature of Person Receiving Stock
		\$		Signature of Witness

Figure 8-20.—An example of a PS Form 17 used to requisition money orders.



## Missing or Damaged Shipments

When a shipment of blank money orders is excessively late or is received in a damaged state, the FLTCINC Postal Officer should be notified by message. Treat MO's received in defective or mutilated condition as spoiled. If large shipments of damaged MO forms are received, request disposition instructions from the FLTCINC Postal Officer. If necessary, immediately reorder blank money order forms.

## MONEY ORDER INVOICE

Each shipment of blank money order forms is accompanied by a PS Form 17 that serves as the invoice. The PS Form 17 is enclosed in the shipment and lists the inclusive serial numbers of all money orders sent.

After each sealed package of money order forms has been verified, the reserve custodian will sign the PS Form 17 (bottom right) as the person receiving the money orders and the COPE will sign as the witness.

File the signed PS Form 17 that accompanied the money orders in the post office file. Code for destruction 2 years after last money order series has been issued.

## ACCOUNTING FOR MONEY ORDER FORMS

Once a shipment of blank money order forms has been received, a record of them must be made. The reserve custodian and COPE must know at any time the status of all blank money order forms. This is done by using DD Form 885, Money Order Control Record. A separate DD Form 885 is used for each different series of money orders. If properly completed and maintained, DD Form 885 will provide the reserve custodian and the COPE with the following information:

- The inclusive serial numbers of each money order series
- The inclusive serial numbers, number of money orders issued and returned, and date of issue to the Postal Clerk(s) or date of return to the reserve custodian
- The inclusive serial numbers of money orders currently held by the Postal Clerk(s)

- The inclusive serial numbers and number of money orders remaining in each series

## Money Order Control Record

DD Form 885 is completed (see figure 8-21) and maintained by the COPE and reserve custodian. To complete DD Form 885:

Block 1: Enter your office FPO address.

Block 2: Enter the source from which the blank money order forms were received.

Block 3: Enter the first and last serial numbers of the money order series.

Block 4: Enter the total number of forms received in the shipment.

Block 5: Enter the date the shipment of forms was received.

Block 6: Enter the registered number(s) under which the shipment of forms was received.

Block 7: Obtain the signature of the reserve custodian.

Unused blank money order forms must be returned to the money order custodian at the end of the business day. However, the clerk can retain unused money orders under extenuating circumstances when permission is granted in writing by the commanding officer.

Finance clerks should also maintain DD Form 885 in their safe folder indicating transfers of custody of money order forms with the reserve custodian, COPE, or another postal clerk.

## Safeguarding DD Form 885

The DD Form 885 records the history of money orders that were in your possession or transferred from you to another clerk. This is probably the most important routine document that you will keep. Safeguard your DD Form 885 in your safe and make sure that you are the only one that records information on it.

## MONEY ORDERS HELD BY POSTAL CLERK

Money order forms with the lowest serial numbers should be issued first. Newly received money order forms should not be issued until the stock of old forms have been used. You should request money order forms in blocks of 100. If you receive forms in less



than blocks of 100, then you and the custodian must verify each money order by serial number.

Do not open a sealed package (100) of money order forms until you are ready to use them. Each time you open a sealed package of blank money order forms, you must verify each form by serial number before you issue them.

## **SAFEGUARDING MONEY ORDER FORMS**

Blank money order forms are valuable and must be kept locked up when not in use. When money order business is being conducted, blank money order forms should be kept out of reach of postal customers. Reserve stocks of money order forms in the custody of the designated custodian or a postal clerk must be kept in one of the following places to which the accountable person has sole access:

- A vault
- A three-position combination safe
- Another container offering comparable security of a vault or three-position combination safe

If you are a money order clerk, you must have a metal cashbox, drawer, or safe equipped with a suitable locking device. Blank money order forms must be stowed in one of these containers when you are not transacting money order business. To establish individual responsibility, combinations or keys must not be available to other persons. If your stowage container is a locked box or drawer, it should be secured in a safe during temporary absences or during nonbusiness hours. Develop good security habits when you start working in a post office. They will be important to you as you advance in rate and take charge of a large post office. Unless you have written permission to do otherwise, return all unused blank money order forms to the custodian for safekeeping at the close of business each day.

## **CARE IN HANDLING MONEY ORDER FORMS**

Money order forms are processed by machine. Therefore, they should not be folded, creased, smudged, or otherwise mutilated. They should not be stored in damp or other unsuitable areas. The serial number on each money order set is machine-readable and must not be smudged. You should never handle the upper-third portion of the money order set. When you

open a new package of money order forms, you should keep the remaining forms under pressure. A great deal of pressure is not needed, just enough to keep the forms flat is all that is required.

*Q8-30. What all is involved in the sale of money orders?*

*Q8-31. List the parts of the domestic money order set.*

*Q8-32. Each money order set is assigned an 11-digit number. Which numbers are used by the MPO to identify the money order?*

*Q8-33. What PS form is used to order blank money order forms?*

*Q8-34. Blank money order forms should be ordered at least how many days before they are actually needed?*

*Q8-35. What procedures should be taken if your military post office runs short of blank money order forms?*

*Q8-36. Blank money order forms are packaged in units of what amount?*

*Q8-37. What DD form is used to account for the custody, control, status, and transfer of blank money order forms?*

Now turn to appendix 1 to check your answers.

## **MONEY ORDER EQUIPMENT**

---

**Learning Objective:** *Identify the parts of, and the security requirements for, the money order imprinter.*

---

In addition to the money order form set, you will use a money order imprinter while issuing money orders. The money order imprinter serves an important function in the money order process. The settings and its use are explained below.

## **MONEY ORDER IMPRINTER**

The money order imprinter is simple to operate. It is quick, efficient, and designed to save time and effort at the finance window. The money order imprinter you will be using is provided to Military Post Offices by the U.S. Postal Service and is considered accountable equipment under custody of the COPE.

## MONEY ORDER IMPRINTER OPERATING INSTRUCTIONS

Operation of the money order imprinter is broken down into 5 easy steps. See figure 8-22 while reading the steps listed below.

Step 1: Setting the date:

From *left to right* align the date fingertip key tabs to the face plate numerals as follows:

- **YEAR:** The light gray key tab should be aligned to the proper decade digit, the dark grey key tab to the year digit.
- **MONTH:** The light gray key tab should be aligned to the proper ten digit of the month, the dark gray key tab, to the unit digit.
- **DAY:** The light gray key tab should be set to the proper ten digit, and the dark gray key tab, to the unit digit of the day.

NOTE: The repeated digit in all of the 10 columns of the date section are to assure long character life in these frequently used digit columns.

Always ensure the correct date is set on the imprinter before beginning the business day.

Step 2: Setting the dollar amount:

Align the DOLLAR and CENT keys to the proper digits on the faceplate for the desired money order amount. Verify the desired amount in the verification windows of the imprinter before inserting a blank money order form set.

NOTE: The \$1,000.00 and \$100.00 columns have been fitted with stops (red plastic strips) to help prevent amounts from being printed over the current postal service limits. These stops can be adjusted for future limit changes.

Step 3: Aligning the money order form set:

Place the money order form set face up into the alignment tray of the imprinter (perforated tab/stub to the left). The red guideline should appear on the tray base to the left of the money order set stub when the form is in the proper location.

To avoid serious damage to the imprinter, never actuate the operating lever without a form set inserted into the imprinter. Ensure that the operating lever is in its full resting position before attempting to change position of any of the date or dollar amount keys.

Step 4: Operating lever imprint stroke:

Grasp the grip handle of the operating lever assembly with your right hand and pull the lever all the way forward and down until it reaches the bottom of its stroke (listen for the “popping” sound).

NOTE: To assure a quality imprint, a built-in ratchet mechanism will not allow the operating lever to be returned to its rest position until a complete lever stroke has been made.

Hold onto the handle and allow it to return to its full rest position. Remove the form set from the imprinter and return all DOLLAR and CENT keys to their safe (no value) positions.

Step 5: Checking the imprint of the money order:

After imprinting the money order, check the imprint to assure that the correct value and date were struck. Also check to make sure that there is no overstrike of the imprint onto the money order serial number.

Remove the money order voucher (white portion), and the carbons from the set. You must retain all vouchers and carbons to complete your money order business report at the end of the day. Maintain the vouchers in serial number sequence throughout the day.

You must maintain serial number continuity; always use the form with the lowest serial number first. If you issue a money order out of serial number sequence, DO NOT recall or spoil it; rather, return to the proper sequence as soon as possible.

## SECURITY OF MONEY ORDER IMPRINTER

The money order imprinter must be kept secured at all times (out of the reach of customers) because it can be used to print negotiable instruments. The money order imprinter is considered accountable equipment and its loss will be reported as a postal offense.

*Q8-38. What is the first step in operating the money order imprinter?*

*Q8-39. The money order imprinter is not required to be stowed in a locked container when not in use; however, it is considered as a piece of accountable equipment and should be kept out of sight. (True/False)*

Now turn to appendix 1 to check your answers.

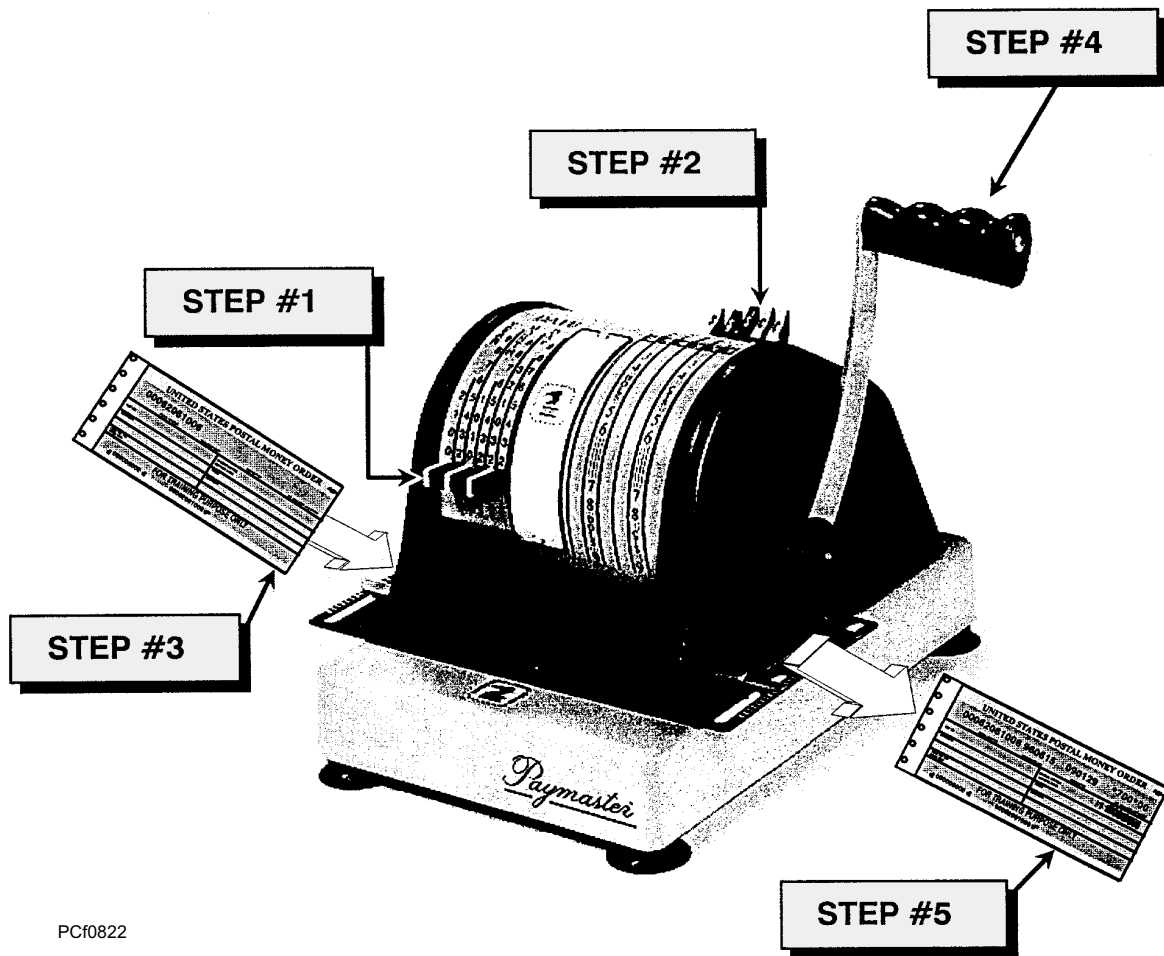

PCf0822

Figure 8-22.—An example of a money order imprinter.

## ISSUING MONEY ORDERS

**Learning Objective:** *Recognize the procedures for issuing and cashing domestic money orders.*

The domestic money order with which you have become familiar is sold at all U.S. civilian and most military post offices. Refer to Module S of the DMM for the maximum amount a domestic money order can be issued for. All money orders must be issued on the money order imprinter. Under no circumstances should money orders be handwritten or typed.

### MONEY ORDER FEES

A fee is charged for each money order issued. If you issued three money orders to the same customer, you would have to collect three fees. Refer to Module S of the DMM concerning fees for issuing a money order from an MPO. The fee for a money order issued by a civilian post office is more than from an MPO.

## ISSUING PROCEDURES

Now that you are familiar with the money order form set and the money order imprinter, we will go through the steps in preparing for and actually issuing the money order. The following is generally the procedure from start to finish:

- Obtain the blank money order forms from the COPE or reserve custodian. You should get a sufficient number of forms necessary to conduct business for that day.
- If the money orders are loose (less than a sealed package of 100), verify each money order by serial number. As each package is opened, each money order serial number must be verified before issuing from that package.
- Get your imprinter from its storage place and test to see that it is operable.
- Set the correct date.

- Check the print handle. Ensure the handle is in the up position.
- Greet the customer.
- Check the customer's identification to determine eligibility for service.
- Verify the dollar amount of the money order desired by repeating the amount back to the customer.
- Set the amount requested on the amount keys.
- Insert the blank money order set so that it lies flat within the guides of the imprinter. Do NOT touch the upper-third portion of the money order form set.
- Now move the print handle all the way down till you hear the popping sound, then release it.
- Return the imprinter to the clear state by returning the money amount keys to the asterisk (\*) positions and return the handle to the up position.
- Remove the form set from the imprinter. Again, do NOT touch the upper-third portion of the set.
- If any item has not printed clearly or correctly, treat the money order as spoiled. Spoiled money orders are covered later in this chapter.
- Collect the amount for which the money order is issued plus the fee.
- Detach and file the voucher in numerical sequence, taking care not to bend, fold, or mutilate it, and the carbons. Give the customer the customer's receipt and money order.
- Advise the customer to complete the money order and receipt by filling in the Pay To and From blocks as soon as possible and to retain the customer's receipt.

## **SPOILED MONEY ORDERS**

No alterations, changes, or erasures, either in words or figures, shall be made on any part of the money order form set. If a money order is incorrectly imprinted or completed incorrectly by the customer, it is considered to be SPOILED. A money order is treated as spoiled ONLY on the day it was purchased, and ONLY if the money order and customer's receipt is presented to the same clerk from whom it was purchased. If the money order is presented to another

clerk or returned after the date of purchase, the money order should be cashed and a "No-Fee" money order issued as a replacement. No-fee money orders will be covered after you learn about spoiled or incorrectly prepared money orders.

## **SPOILED OR INCORRECTLY PREPARED MONEY ORDERS**

The biggest reason for spoiling money orders is due to clerk error during issuing. Errors may include:

- Setting an incorrect date on the imprinter,
- Setting an incorrect dollar amount, or
- Imprinter malfunction (does not produce a clear impression).

Money orders can also be spoiled by the customer. Some examples are

- Purchaser or payee information is written incorrectly on the money order,
- Purchaser inadvertently tears the money order, or
- Purchaser requests a money order for wrong amount.

Whatever the reason, if the money order becomes unusable on the same business day, follow the steps below (see figure 8-23):

Step 1: Collect the money order and customer receipt from the customer. Destroy the customer receipt and corresponding money order voucher. DO NOT DESTROY the money order.

Step 2: Write or stamp SPOILED in the PAY TO and FROM section of the money order.

Step 3: Place the spoiled money order in numerical sequence in the stack of issued money order vouchers.

Step 4: Issue a new money order to the customer for the same amount as the one spoiled (if amount was correct), but DO NOT collect a fee.

## **CONDITIONS FOR ISSUING "NO FEE" MONEY ORDERS**

A No-Fee money order is a money order issued or sold WITHOUT collection of a fee. You will issue money orders and NOT collect a fee when:

- A money order is used for remittance as part of official USPS business. An example would be

① Collect CUSTOMER RECEIPT and CARBONS (if available) from the patron and *destroy* along with the corresponding VOUCHER.

DO NOT RETURN TO YOUR POST OFFICE IF FOUND  
**RECEIPT** DO NOT SEND THIS RECEIPT FOR PAYMENT RECORDS  
 KEEP IT FOR YOUR RECORDS

 <b>UNITED STATES POSTAL MONEY ORDER</b>		<small>15-800</small> <small>000</small>	
00062061006	960615	090129	*016*18
<small>SERIAL NUMBER</small>	<small>YEAR, MONTH, DAY</small>	<small>POST OFFICE</small>	<small>U.S. DOLLARS AND CENTS</small>
PAY TO <b>NOT NEGOTIABLE</b> <b>SPOILED</b>		CHECK WITH IMPROPER USE <b>FOR USE AS SAMPLE</b>	
ADDRESS		FROM <b>SPOILED</b>	
COD NO. OR USED FOR		ADDRESS	
<b>FOR TRAINING PURPOSE ONLY</b>			
POSTAL 00		① 000008002 ① 00062061006 ①	

<b>CUSTOMER</b>
00062061006
<small>SERIAL NUMBER</small>
PAY TO <b>NOT NEG</b>
ADDRESS
COD NO. OR USED FOR
<small>This receipt is your guarantee for a refund of the amount of this money order if it is lost or stolen, provided you fill in the Pay To and From sections on the front of the money order and present this receipt to the office provided. No claim for improper payment permitted. If your money order is lost or stolen, present this receipt for a refund at your Post Office.</small>

② WRITE or STAMP the word **SPOILED** in the "Pay to" and "From" section of the money order.

③ Place the "SPOILED" money order in numerical sequence with the other issued money order vouchers.

④ Use the next available blank money order and reissue for the same amount.  
**DO NOT COLLECT A FEE.**

PCf0823

Figure 8-23.—An example of a spoiled money order.

issuing a money order for funds collected by finance clerks for postage meter business.

- A customer spoils a money order and returns it to an MPO (any window clerk selling money orders) to have it replaced on any day after the date of sale. In this situation:

—The customer completes the Pay To and From sections on the front of the money order, if not already completed. The customer must also endorse the original money order on the reverse.

—The customer must give the money order and customer receipt to the money order clerk.

—The money order clerk issues a new money order for the same amount as the original money order. Include the original money order with your day's business report as a PAID MONEY ORDER. Do NOT collect a fee.

## CASHING MONEY ORDERS

As a money order clerk, you will also be cashing postal money orders. Only USPS money orders may be cashed at MPOs. Do not cash international money orders or personal checks. **EXCEPTION:** Canadian money orders may be cashed if they are drawn on the United States and the amount is given in U.S. currency. Money orders are valid for an indefinite period.

### IDENTIFICATION

Before you accept a money order for cashing, you must identify the person whose name appears on the “Pay To” line. Military personnel, their dependents, and authorized U.S. citizen government employees are provided with official identification cards (see chapter 1). Identification cards will identify the bearer by photograph and signature. In those areas or under certain circumstances where authorized personnel are not issued official government identification cards, U.S. passports may be accepted for identification. Letters, club membership cards, social security cards, driver’s permits, or similar items may **NOT** be accepted as proof of identity.

### SIGNATURE REQUIREMENTS

The payee of a money order must sign the instrument in the presence of the accepting clerk. You may accept any signature of the person cashing the money order that is not different from the name given on the order. Money orders payable to organizations, societies, government agencies, and so forth, must be signed by a representative authorized to do so. You may require proof that the person is an authorized representative of that agency. The representative must sign the money order with his or her own name and organizational title.

Use of such titles as Dr., Capt., Sgt., MCPO, or Mrs., is not required in signing a money order for payment, even if the title is used on the face of the money order.

Customers who cannot write may sign by using a mark (usually an X) if a witness is present. The witness cannot be a person assigned to postal duties.

A money order completed by the purchaser to show more than one person as the payee will be paid as follows:

- If the conjunction “or” is used to connect the payees, either payee may cash the order.

- If no conjunction is used, or if the conjunction “and” is used to connect the payees, then all the listed payees must sign the order.

## TRANSFER OF MONEY ORDERS

Only the person whose name appears on the “Pay To” line of a money order may endorse it to another person or a firm. To endorse the money order over to another person or firm the following actions must be taken:

- The intended payee’s name is written on the back of the money order on the “Pay To” line.
- The person transferring the money order signs under the words **ENDORSEMENT SIGNATURE**.
- The person to whom the order was transferred will then sign under the original payee’s signature at the time it is presented for cashing.

## MONEY ORDER CASHING PROCEDURES

Money orders presented for payment should be cashed if you have sufficient funds in your money order account. If you do not have sufficient funds in your account, refer the customer to a local bank or suggest that they return later in the business day.

When a money order is presented for cashing:

- Check the person’s identification. Make sure the person presenting the money order for payment is the purchaser, payee, or first endorsee. If a passport is used as identification by authorized personnel who are not issued official government ID cards, enter the passport number on the back of the money order.
- Check to see if the money order has been changed. If alterations are noted, do not cash the money order. Also check for watermark (picture of Benjamin Franklin) and security threads.
- Check the serial number of the money order against the latest lost or stolen money order list (see figure 8-24). Note that the list shows only the first 10 digits of the serial number. A new, lost, or stolen money order list is published periodically in the Postal Bulletin. Each new list should be removed from the Postal Bulletin and posted at the money order window to replace the old list.



### Missing, Lost, or Stolen U.S. Money Order Forms

#### Do Not Cash — Upon Receipt, Notify Local Postal Inspectors

This listing will be provided to all Postal Service employees responsible for accepting and cashing Postal money orders. All interim notices should be destroyed when the numbers listed appear in the Postal Bulletin. The

actual serial numbers consist of the first 10 digits on the money orders. Check for altered dollar amounts by holding money orders to the light.

011 582 1889 to	385 568 2331 to	2399	401 045 1571 to	1599	414 411 7348 to	7399
011 582 1899	385 599 7554 to	7575	401 294 2700 to	2799	414 640 0757 to	0799
011 588 2900 to	385 774 2024 to	2099	401 310 9505 to	9599	414 965 1727 to	1799
011 588 3099	386 624 1412 to	1599	401 382 5312 to	5399	417 302 8104 to	8199
012 579 5675 to	386 883 8936 to	8999	402 578 7876 to	7899	417 387 6532 to	6599
012 579 5699	387 314 5574 to	5599	403 125 6744 to	6799	417 496 6800 to	6999
013 289 6176 to	387 837 6300 to	6399	403 260 7000 to	7499	417 871 9250 to	9299
013 289 6199	388 828 0656 to	0699	403 280 6470 to	6499	417 930 9533 to	9599
013 610 0014 to	389 696 2400 to	2799	403 685 8600 to	8699	418 164 6500 to	6799
013 610 0099	389 846 3104 to	3135	404 003 0300 to	0399	418 423 9863 to	9899
014 932 1000 to	389 846 3145 to	3195	404 041 8838 to	8899	418 633 5922 to	5999
014 932 1099	389 887 9211 to	9230	404 071 4268 to	4299	418 719 8520 to	8599
014 972 0800 to	389 887 9234 to	9299	404 347 5356 to	5399	418 744 2235 to	2299
014 972 0899	390 001 3182 to	3199	404 347 5548 to	5599	418 962 2848 to	2899
210 221 0548 to	390 001 3500 to	3699	404 726 4500 to	4599	419 543 0286 to	0299
210 221 0599	390 545 5974 to	5999	404 961 5001 to	5199	419 730 0300 to	0399
273 070 8059 to	391 104 6146 to	6199	405 325 0188 to	0198	420 277 0015 to	0049
273 070 8099	391 574 1466 to	1499	406 009 4587 to	4599	420 599 0734 to	0798
273 775 7700 to	391 783 3020 to	3599	406 260 6830 to	6899	420 661 4115 to	4199
273 775 7899	391 792 6100 to	6199	406 459 6641 to	6999	420 758 9500 to	9699
302 000 0000 to	392 668 2956 to	2999	406 733 3000 to	3999	420 969 3951 to	3971
302 123 9999	392 854 8500 to	8899	407 545 1557 to	1599	420 969 3973 to	3999
349 746 2056 to	393 584 7566 to	7699	407 594 0412 to	0599	421 116 3565 to	3599
2099	393 650 0074 to	0099	407 692 9100 to	9299	421 130 9300 to	9399
350 518 7350 to	393 838 8316 to	8499	407 959 2190 to	2199	421 313 4500 to	4599
7374	393 893 6007 to	6099	408 265 2275 to	2288	421 364 5537 to	5599
360 011 1690 to	394 126 6907 to	6999	408 499 7700 to	7799	421 656 2609 to	2699
1699	394 189 0405 to	0599	408 499 7900 to	7999	421 988 9700 to	9799
360 168 6008 to	394 822 3243 to	3278	408 682 8484 to	8599	422 172 4667 to	4699
6099	394 990 1810 to	1899	408 698 7015 to	7099	422 484 4212 to	4299
360 173 8800 to	395 343 3264 to	3299	409 072 3941 to	3999	422 556 1270 to	1299
8899	395 373 3035 to	3099	410 491 2311 to	2399	422 587 7024 to	7099
360 324 2326 to	395 396 9649 to	9799	410 694 8400 to	8599	422 819 7533 to	7599
2399	395 970 3240 to	3299	410 775 1500 to	1599	422 842 5073 to	5087
362 861 3064 to	397 622 4054 to	4099	410 795 7927 to	7999	422 907 7563 to	7599
3099	397 819 8902 to	8999	410 867 0917 to	0966	424 500 6050 to	6099
373 006 2176 to	398 149 7200 to	7699	410 867 0970 to	0999	424 641 8500 to	8599
2199	399 070 0872 to	0899	411 868 1023 to	1199	424 871 6600 to	6699
374 768 2600 to	399 156 7119 to	7199	411 922 2322 to	2399	425 298 2352 to	2399
2699	399 203 5064 to	5099	412 193 0900 to	0999	425 418 4269 to	4299
375 169 4400 to	399 296 9910 to	9999	412 395 8599 to	8699	425 418 4405 to	4499
4599	399 396 8935 to	8999	412 485 6500 to	6599	426 547 4566 to	4599
375 829 3400 to	399 792 7775 to	7799	412 885 5953 to	5999	427 412 6337 to	6499
3499	400 427 1051 to	1999	414 193 3608 to	3674	427 481 0900 to	0999
375 851 9100 to	401 045 1505 to	1549	414 193 3677 to	3699	428 027 2742 to	2752
9199					429 474 4172 to	4199
376 196 0911 to						
0999						
378 085 3679 to						
3699						
378 351 1063 to						
1099						
379 843 5100 to						
5199						
380 093 9600 to						
9699						
380 165 1165 to						
1199						
381 325 4500 to						
4599						
381 604 2510 to						
2699						
381 645 9525 to						
9599						
383 314 3968 to						
3999						
383 892 1000 to						
1344						
383 892 1382 to						
1399						
384 925 3641 to						
3654						



PCf0824

Figure 8-24.—An example of a Missing, Lost, or Stolen U.S. Money Order Forms list.

- Require the customer to sign the money order above the words ENDORSEMENT SIGNATURE.
- Stamp the money order with the APDS and initial it (see figure 8-25).

Money orders should be cashed regardless of whether such orders have been folded, stapled, or otherwise mutilated, provided the entries are clear and complete.

Paid money orders must not be mixed with money order vouchers or spoiled money orders. They will be

 <b>UNITED STATES POSTAL MONEY ORDER</b> <span style="float: right;">15-800 000</span>	
<b>00062061006 980610 090129 *700*00</b>	
<small>SERIAL NUMBER</small>	<small>YEAR, MONTH, DAY</small>
<small>POST OFFICE</small>	<small>U.S. DOLLARS AND CENTS</small>
<b>PAY TO Billy Joe Bobalink</b>	<small>CHECK WRITER IMPRINT AREA</small> 
<small>ADDRESS</small> <b>USS UNDERWAY CV-66</b>	<small>FROM</small> <b>Sarah Mae Cloverdale</b>
<b>FPO AE 09561</b>	<small>ADDRESS</small> <b>689 Lakeview Drive</b>
<small>COD NO. OR USED FOR</small> <b>Mikasa china set.</b>	<b>Burlington, NC 27217</b>
<b>FOR TRAINING PURPOSE ONLY</b>	
<small>   000008002   </small> <small>00062061006   </small>	

### MONEY ORDER - FRONT

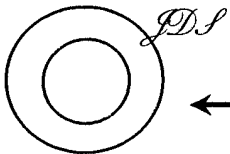
<p style="text-align: center;"><small>MAXIMUM VALUE SEVEN HUNDRED DOLLARS</small></p> <p style="text-align: center;"><i>Billy Joe Bobalink</i></p> <hr/> <p style="text-align: center;"><small>ENDORSEMENT SIGNATURE</small></p>	<div style="border: 2px solid black; padding: 5px; width: fit-content; margin: 0 auto;"> <b>SIGNATURE OF PAYEE</b> </div>
	<div style="border: 2px solid black; padding: 5px; width: fit-content; margin: 0 auto;"> <b>MONEY ORDER CLERK'S INITIALS and APDS</b> </div>
<p><small>WARNING - CASHIER REQUIRE POSITIVE IDENTIFICATION</small></p>	

### MONEY ORDER - REVERSE

PCf0825

Figure 8-25.—An example of required endorsements for cashing money orders.

set aside for inclusion in the money order report, which will be discussed in the next section of this chapter.

- Q8-40. *The maximum amount that a domestic money order can be made out for can be found in what publication?*
- Q8-41. *A single fee is charged for two domestic money orders issued at an MPO. (True/False)*
- Q8-42. *What procedure must be followed when an error is made while you are issuing a domestic money order?*
- Q8-43. *When a customer returns a money order with an error after the day of issuance, what fee, if any, is charged for a new money order? What procedure is followed?*
- Q8-44. *Money orders are valid for what maximum period of time?*
- Q8-45. *When a money order is cashed, what information is placed on the reverse side of the money order?*

Now turn to appendix 1 to check your answers.

## MONEY ORDER REPORTS

---

**Learning Objective:** *Recall the procedures for preparing money order reports.*

---

At the end of each business day, when money orders are sold, you must prepare a money order report. The report must account for all money orders sold, spoiled, and cashed during the day. The COPE is responsible for ensuring that reports are prepared and submitted for each day money order business is conducted. The money order clerk prepares the report. Reports are submitted on PS Form 6019, Military Post Office (MPO) Report of Money Order Business. The report should be typed and prepared in an original and two copies. Before you start to prepare the report, make sure that all the issued money order vouchers and any spoiled money orders are accounted for and are in serial number order and that all paid money orders (cashed) are accounted for. Remember you learned that money order sets are issued in serial number order (that is, the lowest serial number to the highest). Your vouchers and spoiled money orders must be kept in the same order. After you have placed the vouchers and spoiled money orders (if any) in serial number order, you must determine the total cash value of the money orders sold. To do this you will need an adding machine to run a tape listing the amount of each money order sold.

## MONEY ORDER TAPES

You must prepare two separate adding machine tapes reflecting the day's money order transactions. Before you start to prepare the tapes, gather together the following items:

- Money order vouchers
- Spoiled money orders (if any)
- Cashed money orders (if any)

Prepare a money order tape (see figures 8-26/27) following these steps:

- Advance the tape until you have a blank space of about 2 inches at the top.
- Clear the adding machine.
- Enter the amount shown on each voucher. If there are any spoiled money orders, leave a blank space where the amount would normally appear. This step shows that the sixth money order in this series was spoiled.
- Now total the voucher amounts and advance the tape two or three spaces.
- Multiply the total number of vouchers by the money order fee. Example: The money order fee is 30 cents and there are nine money orders issued— $9 \times 30 = \$2.70$ . Fees are not charged for spoiled money orders. Advance the tape another two or three spaces.
- Enter the amount of each money order paid (cashed), if any. In this example you cashed one. Total the amount.
- Subtract the total amount of the cashed money order from the total amount of the money orders sold and the fees. This will be the amount that will be exchanged for a U.S. Treasury check and forwarded with your money order report.
- Remove the tape from the adding machine.
- Run a second tape using the same methods listed above and compare the totals of both tapes.

After both money order tapes have been completed (see figure 8-27), you must carry out the following steps:

- Place an impression of the APDS in the space you left at the top of each tape.
- List the first and last serial numbers of the money orders used. Use only the first 10 digits.

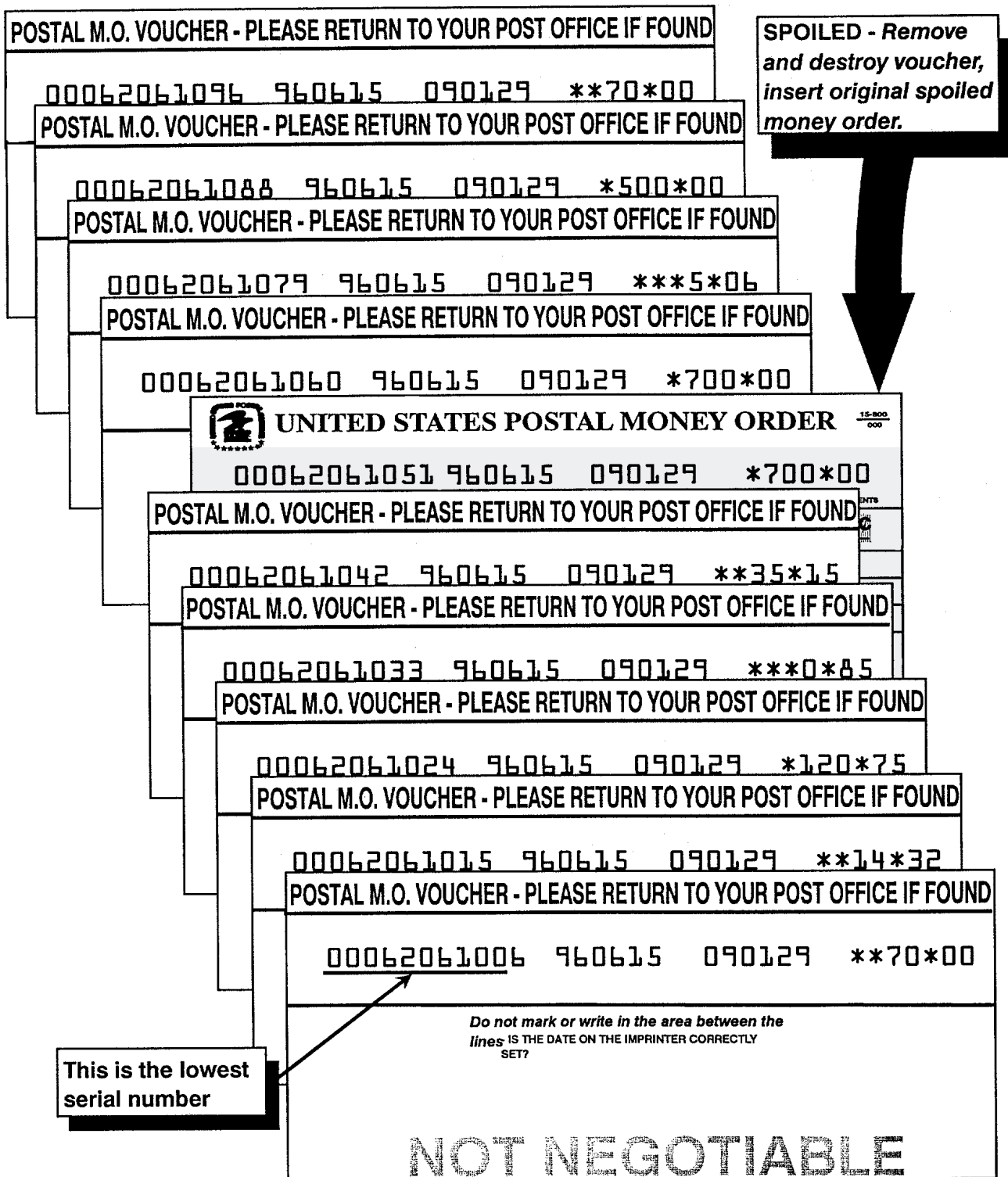

PCf0826

Figure 8-26.—An example of issued and spoiled money orders.

- Print or stamp the word SPOILED in each space left blank for a spoiled money order.
- Identify the money order fees by printing MONEY ORDER FEES.
- Identify the money orders sold by printing MONEY ORDERS ISSUED.
- Identify the money orders paid (cashed) by printing PAID MONEY ORDERS.

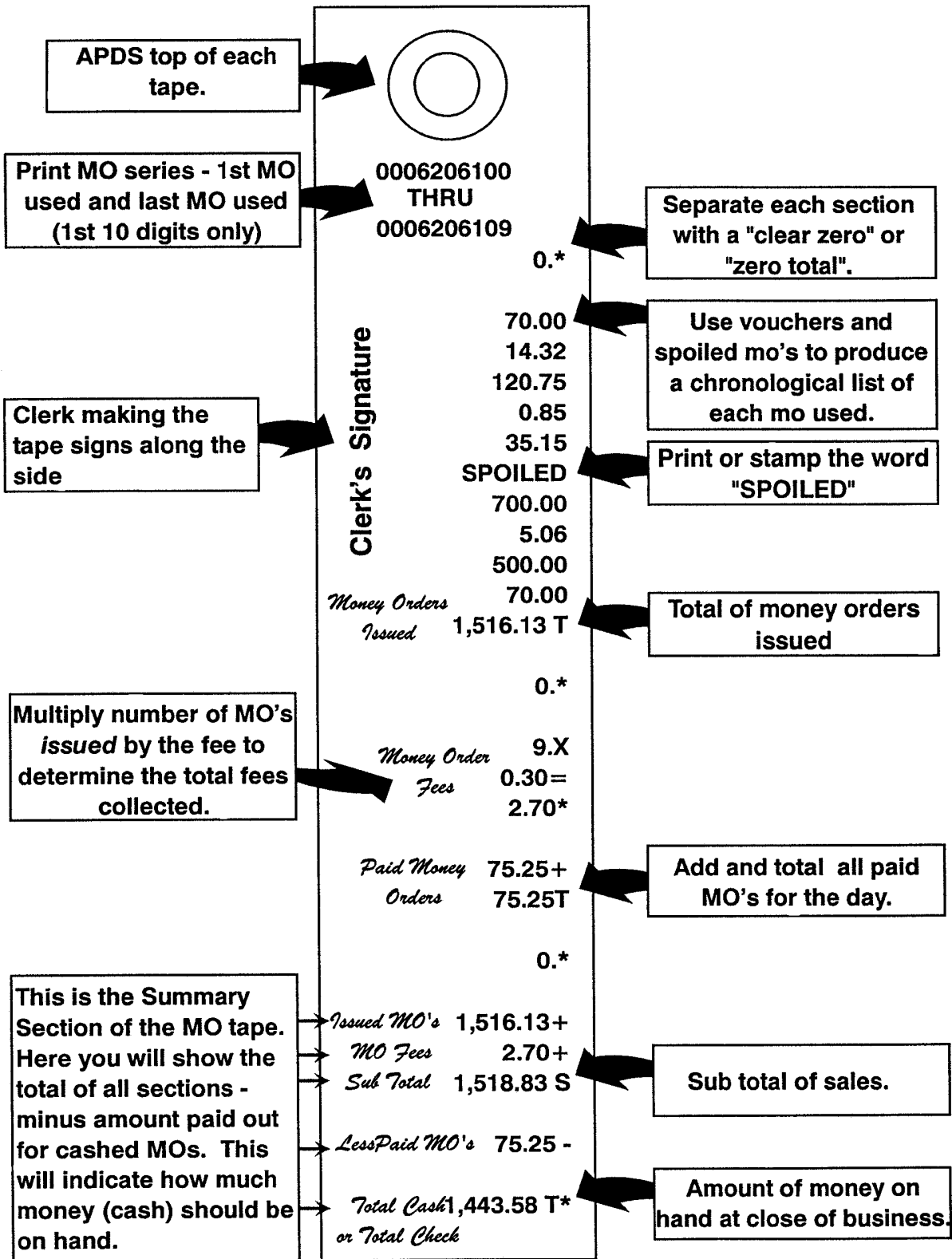

PCf0827

Figure 8-27.—An example of a completed money order business tape.

- Show a summary of the report period. The total cash shown should be what is on hand.
- Sign the tapes.

After you have completed your adding machine tapes, you are ready to prepare your money order report. First, however, count the cash that you received from selling money orders. The amount of cash, minus the amount for paid money orders, should equal the amount of the cash shown on the tape.

Remember that the money order tape must be in duplicate. This means you prepare two tapes separately. Do not try shortcuts by using carboned calculator tape.

### PS FORM 6019

PS Form 6019 is divided into five parts:

- Heading
- Section I—Money Orders Issued
- Section II—Paid Money Orders and Checks Included in Summary
- Section III—Cash Summary
- Remarks and Closing section

Now you will learn how to fill out PS Form 6019 one part at a time.

### Heading

Start by completing the heading portion of the form. This section contains information from the office submitting the report (see figure 8-28). Instructions for completing each block are as follows:

Block 1: This is the MPO's five digit UIC number with the number 9 at the end. Example: UIC 00001 = 000019.

Block 2: Enter the MPO's unit number: UNIT 1, UNIT 2, etc. If the report is from the main MPO, or the only MPO, enter PARENT.

Block 3: No business days. Use this block to report days when money orders are not sold, or when MO business is suspended. Enter the date of the first no business day in the From line. Enter the date before the day that business resumes in the To line.

Block 4: Enter the complete official address of the office that issues the report. Always include the proper title of the unit commander (Commanding Officer).

Block 5: Enter the registry number that will be used to mail the report to USPS Money Orders, Citibank (Nevada) Lock Box Operations-Zone 1127, PO Box 504339, The Lakes, NV, 88905-4339. Postal activities overseas that mail their money order report by Express Mail will enter the Express Mail number in this block.

Block 6: Enter the date of the report: Day/Month/Year. Example: 15 Jun 00.

After completing the heading, next is the body of the report. This area is made up of three sections:

### Section I—Money Orders Issued

Using the information from the money order business tape (see figure 8-27), you will complete the blocks of Section I (see figure 8-29) as follows:

Block 7: Enter the serial number of the first money order used in the From line (First 10 digits only), then enter the serial number of the last money order used in the Thru line (First 10 digits only).

Block 8: Enter the quantity of money orders USED, SPOILED, and ISSUED on the appropriate line. Subtract the first money order used from the last money order used and add one; this will be the number used.

U.S. POSTAL SERVICE MILITARY POST OFFICE (MPO) REPORT OF MONEY ORDER BUSINESS		
MPO Office ID No. (APO/UIC) <b>①</b> 000019	Unit No. <b>②</b> PARENT	Instructions: See DOD 4525.6-M
Issue Office Address <b>④</b> COMMANDING OFFICER USS UNDERWAY (CV-66) FPO AE 09561-0001	No Business was Conducted <b>③</b> From 13 JUN 00 To 14 JUN 00	
	Transmitted under Registry No. <b>⑤</b> RR 123 456 789 US	For Business of (Date) <b>⑥</b> 15 JUN 00

PCf0828

Figure 8-28.—An example of a completed heading of PS Form 6019.

SECTION I MONEY ORDERS ISSUED		
Block Serial Nos. Used		
From 0006206100		
Thru 0006206109		
No. Used 10		
No. spoiled 1		
No. issued 9		
	Amount	Fee
TOTAL ▶	1,516.13	2.70
Block Serial Nos. Used		
From		
Thru		
No. Used		
No. spoiled		
No. issued		
	Amount	Fee
TOTAL ▶		
Block Serial Nos. Used		
From		
Thru		
No. Used		
No. spoiled		
No. issued		
	Amount	Fee
TOTAL ▶		
GRAND TOTAL ▶	1,516.13	2.70
NOTE: <ul style="list-style-type: none"> <li>• Carry Grand Total Amount to Item 2, Section III</li> <li>• Carry Grand Total Fees to Item 3, Section III</li> </ul>		

PCf0829

Figure 8-29.—An example of a completed Section I—Money Orders Issued, PS Form 6019.

Subtract spoiled money orders from the used money order total, this will give you the number issued.

Block 9: Enter the total dollar amount of money orders issued and fees collected in their respective positions. Take this information directly from your money order business tape.

NOTE: Repeat the steps for blocks 7, 8 and 9 to report the sale of money orders, when money orders from a different series are used in the same business day.

Block 10: Enter the GRAND TOTAL of all issued amounts and all fees collected. (Total of all series used.)

**Section II—Paid Money Orders and Checks Included in Summary**

Section II lists all PAID MONEY ORDERS and CHECKS remitted for payment with the money order report. Follow the instructions below for completing Section II (see Figure 8-30).

Block 11: Enter the serial number of each PAID money order and its corresponding dollar value. List in numerical sequence, lowest serial number to highest serial number (first 10 digits only).

List all PAID (cashed) money orders by serial no., lowest to highest, and dollar value.

11

SECTION II PAID MONEY ORDERS AND CHECKS INCLUDED IN SUMMARY			
Paid Money Orders			
	Serial No.	Amount	
1	0003751517	75	25
2			
3			
4			
5			
6			
7			
8			
9			
10			
11			
12			
13			
14			
15			
16			
17			
18			
19			
<b>TOTAL (To Item 8. Sec. III) ▶</b>		75	25
Checks			
	Serial No.	Symbol No.	Amount
	9876543210	1234	1,443 58
<b>TOTAL (To Item 9. Sec. III) ▶</b>		1,443	58

List all checks by serial no., symbol no., and dollar value.

13

12 Total of all PAID money orders

14 Total of all checks remitted as payment

PCf0830

Figure 8-30.—An example of a completed Section II Money Orders and Checks Included in Summary, PS Form 6019.

Block 12: Enter the total dollar value of all paid money orders.

Block 13: Enter all CHECKS, by serial number, remitted as payment with the report. Include disbursing symbol number and dollar value.

Block 14: Enter the total dollar amount of all checks remitted.

**Section III—Cash Summary**

Section III is a summary of the day’s business that recaps the total sales and remittances. In this section the TOTAL DEBIT and TOTAL CREDIT blocks must

be the same amount. Follow the instructions below for completing Section III (see figure 8-31).

Block 15: Enter in Item 2 the total amount of money orders issued. This will be the same as the GRAND TOTAL amount from Section I of the report.

Block 16: Enter in Item 3 the GRAND TOTAL fees.

Block 17: Add the amounts from Item 2 and 3 and enter the total in Item 7, TOTAL DEBIT.

Block 18: Enter the total of Paid money orders from Section II.

Block 19: Enter the total of all Checks from Section II.



If submitting your report with a cash remittance instead of a check, enter the word "CASH" in Section III, line 10 and the dollar value in the "Amount" column.

SECTION III CASH SUMMARY		SECTION III CASH SUMMARY	
Debits	Amount	Debits	Amount
1. Balance from Item 13 of Previous report		1. Balance from Item 13 of Previous report	
2. MO's issued (Amount Total Section I)	1,516 13	2. MO's issued (Amount Total Section I)	1,516 13
3. Fees (Fees Total Section I)	2 70	3. Fees (Fees Total Section I)	2 70
4.		4.	
5.		5.	
6. Shortage Correction*		6. Shortage Correction*	
7. <b>TOTAL DEBIT</b> ▶	1,518 83	7. <b>TOTAL DEBIT</b> ▶	1,518 83
Credits	Amount	Credits	Amount
8. Paid money orders (Total Section II)	75 25	8. Paid money orders (Total Section II)	75 25
9. Checks as listed (Total Section II)		9. Checks as listed (Total Section II)	1,443 58
10. <b>CASH</b>	1,443 58	10.	
11.		11.	
12. Overage Correction*		12. Overage Correction*	
13. Balance carried to item 1 of next report		13. Balance carried to item 1 of next report	
14. <b>TOTAL CREDIT</b> ▶	1,518 83	14. <b>TOTAL CREDIT</b> ▶	1,518 83
* Attach copy of Form 1908, Financial Adjustment Memorandum		* Attach copy of Form 1908, Financial Adjustment Memorandum	

Figure 8-31.—An example of a completed Section III Cash Summary, PS Form 6019.

PCf0831

Block 20: If CASH is being remitted instead of a check, enter the word CASH in Item 10 and enter the dollar amount in the amount column.

Block 21: Add Items 8 and 9, or 8 and 10 (as appropriate), and enter the total in Item 14 TOTAL CREDIT.

**Remarks and Closing Section**

The bottom of PS Form 6019 (see figure 8-32) contains the REMARKS section and signature blocks

for the clerk submitting the report and the official who reviews and verifies the report. It also contains a postmark validation block requiring an imprint of the unit's APDS. Follow the instructions given below to complete this part of the form.

Block 22: REMARKS. When two or more clerks sell money orders on the same day, list the other clerk(s) by name in the REMARKS section. Also annotate unusual situations, such as money orders issued out of sequence in this area.

**Figure 8-32.—An example of a completed Remarks and Closing Section, PS Form 6019.**

Block 23: The clerk preparing the report signs the report followed by his or her grade.

Block 24: The verifying official will sign in this block, followed by his or her grade.

Block 25: Place an impression of the APDS in this block. This completes the preparation of the report.

### **OTHER THAN ORDINARY MONEY ORDER REPORTS**

So far you have learned how to prepare an ordinary money order report. In this section we will discuss some situations that require additional entries to be made on the money order report or other actions that must be taken.

#### **Different Series of Money Order Forms**

At times you may have to issue money orders from two different number series on the same business day. When this happens prepare your tape in the same manner as when money orders are all issued from the same series. However, list and make separate totals for each series on the tape. Then also make a separate entry in Section I, PS Form 6019 (see figure 8-33).

#### **Money Orders Issued Out of Order**

Through error you may at times issue money orders out of serial number order. You should return to the proper series as soon as the error is noted. The money orders issued out of series order will be listed as a break in series in section I, PS Form 6019. A statement will also be made in the Remarks section, PS Form 6019, that the money orders were issued out of order (see item 1, figure 8-34). On the date the break in series is reached, list the serial numbers of the money orders issued for that day in section I, PS Form 6019. Another statement (see item 2, figure 8-34), will be

made in the Remarks section referencing the money orders that were previously issued out of order.

#### **Missing Money Order Form Set**

If, upon opening a sealed package of 100 money orders that are to be issued, you find a form set is missing, follow these procedures:

- Notify the COPE, MPO supervisor, or postal officer.
- Prepare a letter reporting the missing money order and forward to the source of supply. Place a copy of the letter in numerical order where the missing form set would have been and notify the NPFO or PFO.
- Make a statement (see item 3, figure 8-34), in the Remarks section of PS Form 6019 when the missing money order is reached in numerical order.

If a money order set is discovered missing after it was previously accounted for, notify the COPE, MPO supervisor, or postal officer. If the form cannot be found, the loss must be reported by message to MPSA as a postal offense. A statement (see item 4, figure 8-34), will also be made in the Remarks section of PS Form 6019.

#### **Missing Voucher**

If you discover that a money order voucher is missing, enter on your money order tape, in the space where the amount of the missing voucher would normally appear, the words MISSING VOUCHER.

- After you audit your money order account, there should be an overage.

0006206196 THRU 0006206199	
0.*	
70.00+	
14.32+	<i>Issued MO's</i>
120.75+	
0.85+	
205.92T	
4.00x	
0.30	<i>MO Fees</i>
1.20*	
4440530000 THRU 4440530004	
0.*	
10.00+	
180.00+	<i>Issued MO's</i>
68.50+	
0.67+	
101.50+	
360.67T	
5.00x	
0.30	<i>MO Fees</i>
1.50*	
0.*	
250.00+	<i>Paid Money Orders</i>
5.00+	
255.00T	
0.*	
205.92+	<i>Total MO's</i>
360.67+	<i>Issued</i>
566.59T	
1.20+	
1.50+	<i>Total MO Fees</i>
2.70T	
0.*	
566.59+	<i>Total Issued</i>
2.70+	<i>Total Fees</i>
569.29S	<i>Sub Total</i>
255.00-	<i>Less Paid MO's</i>
314.29T	<i>Total Cash or Total Check</i>

Money Order Tape indicating a "split block" business day. Note that there are two different sets of money order serial numbers and how they are prepared on the tape. The total from each block is combined in the summary area of the tape.

**BLOCK 1**

**BLOCK 2**

Add Block 1 and Block 2 Issued MOs

Add Block 1 and Block 2 Fees

Illustration of how to prepare Section I of PS Form 6019 to report money order business when there is a "SPLIT BLOCK" of serial numbers.

SECTION I MONEY ORDERS ISSUED		
Block Serial Nos. Used		
From	0006206196	
Thru	0006206199	
No. used	4	
No. spoiled	0	
No. issued	4	
	Amount	Fee
TOTAL ▶	205.92	1.20
Block Serial Nos. Used		
From	4440530000	
Thru	4440530004	
No. used	5	
No. spoiled	0	
No. issued	5	
	Amount	Fee
TOTAL ▶	360.67	1.50
Block Serial Nos. Used		
From		
Thru		
No. used		
No. spoiled		
No. issued		
	Amount	Fee
TOTAL ▶		
GRAND TOTAL ▶	566.59	2.70
NOTE: • Carry Grand Total Amount to Item 2, Section III • Carry Grand Total Fees to Item 3, Section III		

PCf0833

Figure 8-33.—An example of Section I, PS Form 6019, and tape showing money order sales from two different series of money orders.

– Enter the amount of the overage in Section III, item 4, PS Form 6019 and the notation SEE REMARKS.

– Make a statement (see item 5, figure 8-34), listing the missing voucher by number in the Remarks section of PS Form 6019.

①	<p>REMARKS</p> <p>MOs _____ thru _____ were issued out of sequence, and reflected herein. Return to proper sequence was not possible prior to the close of business.</p>
②	<p>REMARKS</p> <p>MOs _____ thru _____ were issued out of sequence and reported on the MOB report for <u>(Indicate date MOs were issued out of sequence)</u>.</p>
③	<p>REMARKS</p> <p>Upon opening a sealed package of 100 blank MOs, _____ thru _____, MO _____ was missing. The missing money order was reported to _____ in a letter dated _____.</p>
④	<p>REMARKS</p> <p>During normal course of business, MO _____ was discovered missing. Circumstances surrounding the loss of this MO are not known at this time. Action taken to locate the missing MO has met with negative results. Loss has been reported to _____.</p>
⑤	<p>REMARKS</p> <p>Overage due to missing voucher. MO _____ was issued and USPS voucher was not retained. An effort has been made to obtain voucher, but without success. \$ _____ overage is included in this report.</p>
⑥	<p>REMARKS</p> <p>MO _____ issued on _____ was returned by customer for replacement. It was _____ (Give reason for return) _____; therefore, it was treated as "Paid" and a no fee MO issued this date.</p>

PCf0834

Figure 8-34.—Examples of entries required to be made in the Remarks Section of PS Form 6019.

- The COPE will prepare a money order facsimile and mail separately to USPS Money Orders, CITIBANK (Nevada) Lock Box Operation-Zone 1127, PO Box 504339, The Lakes, NV, 88905-4339 (see figure 8-35).

### No-Business Days

Each day of the month must be accounted for on your money order reports. Your money order reports will cover days on which money order business was not conducted as well as the days that money order business was conducted. Days on which money order business was not conducted will be reported showing the inclusive dates in the No Business was Conducted block, PS Form 6019. The no-business date(s) will be listed on the first money order business report following the day(s) on which no business was conducted.

### Suspended Money Order Service

If your post office business is suspended for any reason, follow these procedures:

- Enter BUSINESS SUSPENDED in the Remarks section, PS Form 6019, on the last day money order business is conducted.
- Enter BUSINESS RESUMED in the Remarks section, PS Form 6019, on the first day money order business is conducted following the suspension date.
- Make an entry in the block NO BUSINESS WAS CONDUCTED to cover the date(s) that money order business was suspended.

### No-Fee Money Orders

When a customer returns a money order after the day of issue because of an error, issue a replacement

Army and Air Force use MPO number + 9, Navy and Marine Corps use six-digit OID number

Enter the 10 digit serial number of the voucher that is missing.

Leave Blank

Always Enter A

COPE or verifying Official's Signature

**USPS FACSIMILE M.O. VOUCHER**

8014665446	870202	625859	*	
Serial No. (Include 11th Digit if known)	Year Month Day Date	Post Office ID	Amount	

Preparer's Signature: *Joseph C. Clark* P.O. CAG: **A**

Complete this form for missing vouchers. Send directly to Money Order Division, P.O. Box 14975, St. Louis, MO 63182-9412.

DO NOT MIX THIS FACSIMILE WITH VOUCHERS.  
DO NOT SEND THIS FACSIMILE IN THE WEEKLY VOUCHER SHIPMENT

fold on dotted line

---

UNITED STATES POSTAL SERVICE

OFFICIAL BUSINESS

SEND TO:

USPS MONEY ORDERS  
CITIBANK (NEVADA) LOCK BOX OPERATION-ZONE 1127  
PO BOX 504339  
THE LAKES NV 88905-4339



PENALTY FOR PRIVATE USE TO AVOID PAYMENT OF POSTAGE \$300



PCF0835

Figure 8-35. An example of a Facsimile voucher.

money order. If the customer has the MO receipt, do not charge a fee for the replacement money order. Endorse the money order tape NO FEE next to the amount, and make an entry (see item 6, figure 8-34), in the remarks section showing the replacement money order as a No Fee.

**Duplicate, Defective, and Mutilated Money Orders**

If a duplicate, defective, or mutilated money order is found, it will be treated as spoiled.

If two money order forms are received with the same serial number, cancel one by writing NUMBER DUPLICATED across the face of one of them. The

other may be issued as long as all other information is correct. Forward the canceled money order form set with the next money order business report.

**Financial Adjustment Memorandum**

If the USPS finds an error in your money order remittance, a Credit Memo, Financial Adjustment Memorandum (FAM), is prepared and sent to MPSA. Once MPSA receives the Credit Memo, they will forward 2 copies to the appropriate FLTCINC postal officer and 1 copy to the command concerned. If you receive a Credit Memo, you must report the corrective action taken on your money order report. MPSA will normally require that a copy of the money order report showing the corrective action taken be forwarded to

them. In addition, inform the FLTCINC postal officer of the action taken.

### DISPOSITION OF MONEY ORDER ITEMS

Once you have completed the report, all money order items and cash must be turned over to a designated person for verification, **THAT DAY**. Arrange vouchers in the order in which they were sold. Then place the vouchers in a plain envelope so that they will remain in numerical order and are protected. Do not use staples, paper clips, rubber bands, and so forth, to hold them together. Deliver all vouchers, spoiled money orders, cashed money orders, cash, adding machine tapes, and a completed PS Form 6019 to the person who will verify the report. Aboard ship, the disbursing officer will normally verify the money order report. At shore activities, the person verifying the report may be the COPE, postal officer, or other designated person.

If the report is to be audited and verified at a later time, you will get a receipt for the money order items and the cash.

### Submitting the Report

Once the report has been verified, remit all cash to the disbursing officer in exchange for a U.S. Treasury check. Have the disbursing officer make the check payable to Disbursing Officer, U.S. Postal Service. Overseas shorebased post offices will take cash from money order sales to their servicing U.S. Military banking facility and exchange the cash for a bank check. Enter the registry number (Express Mail number for overseas activities who send money order reports by Express Mail), under which the report is to be sent on the original and file copy of PS Form 6019. If sent by registered mail, prepare a USPS official envelope, EP390B (see figure 8-36), include your office identification (OID) number (UIC + number 9) on the outside of the envelope. If sent by Express Mail, all MO items must be enclosed in an Express Mail envelope.

Place the following items in the envelope:

- Money order tape (one)
- Cashed money orders (if any)
- Money order vouchers

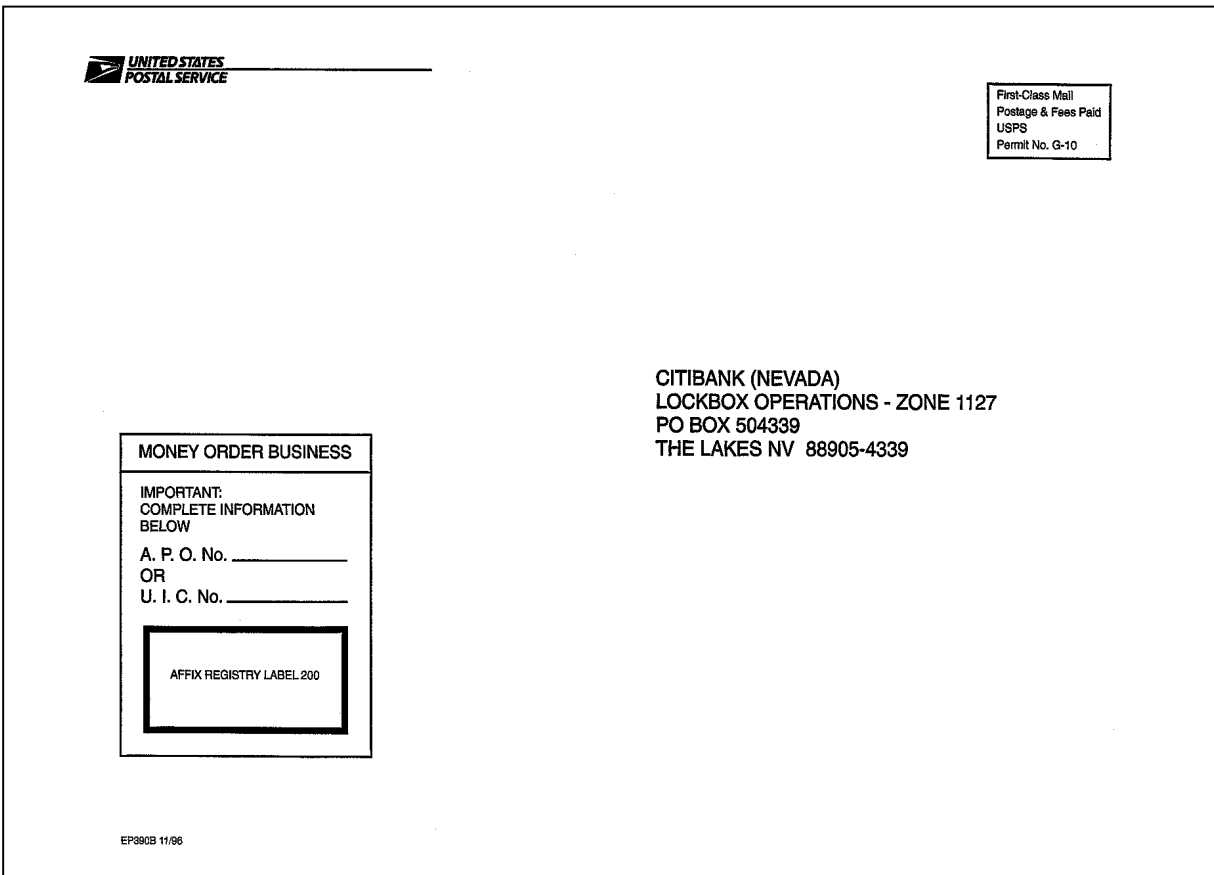

Figure 8-36.—An example of an EP390B.

- Spoiled money orders (if any). (The spoiled money orders are placed behind the vouchers.)
- Remittance check
- Original of PS Form 6019

Register the report and attach the registry receipt and money order tape to the file copy of PS Form 6019. For overseas shorebased post offices that send their MO report by Express Mail, a copy of the USPS Label 11-B used to mail the report will be attached to the file copy of PS Form 6019 along with a carbon copy of the military banking facility check.

*Q8-46. How often are money order reports prepared and submitted?*

*Q8-47. What PS form is used to report daily money order business?*

*Q8-48. The money order report should be prepared in what minimum number of copies?*

*Q8-49. How many adding machine tapes should you prepare in support of the money order report?*

*Q8-50. How many sections are there to the money order report?*

*Q8-51. Each day of each month must be accounted for on money order reports, even the days you do not conduct money order business. (True/False)*

*Q8-52. In what section of the money order report should the credits and debits be listed?*

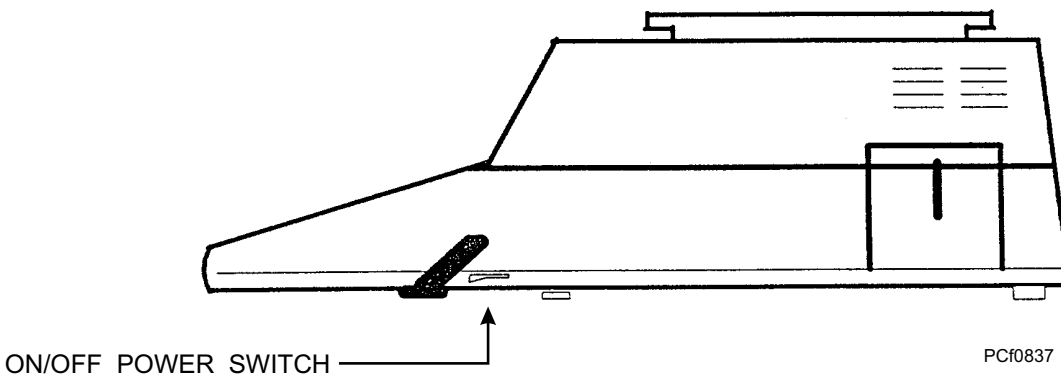
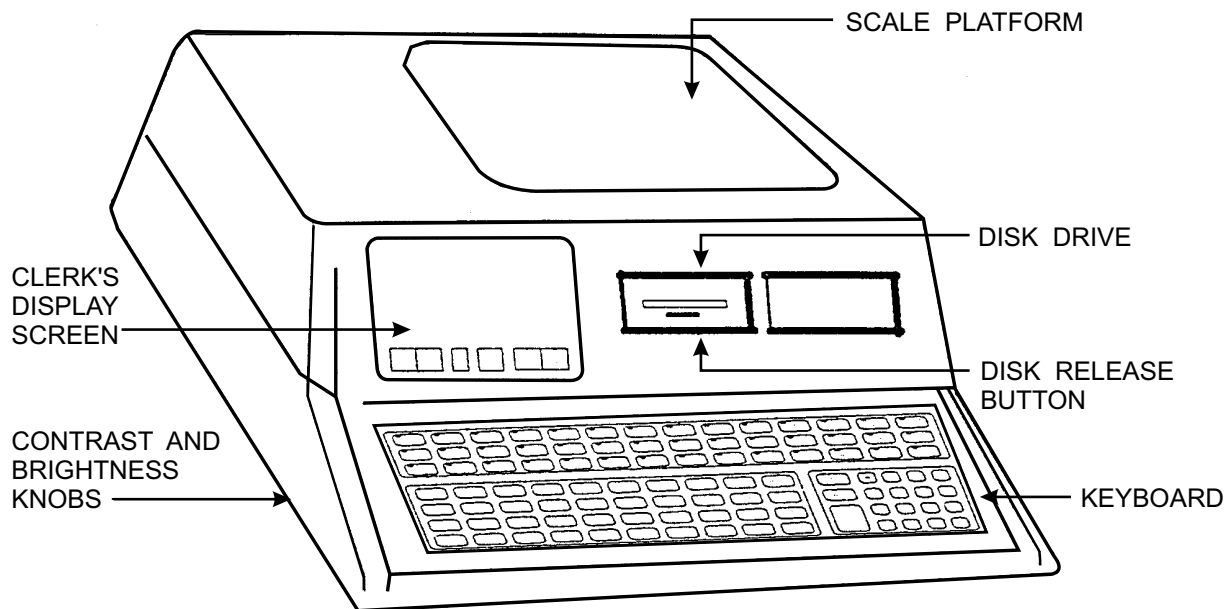

Figure 8-37.—An example of an IRT. (Front and side view)

Q8-53. Where on the money order report would a missing voucher be noted?

Now turn to appendix 1 to check your answers.

### **INTEGRATED RETAIL TERMINAL**

---

**Learning Objective:** *Recall the capabilities and components of an Integrated Retail Terminal (IRT).*

---

The Unisys Series 2000 Integrated Retail Terminal (IRT) is the most technically advanced system available at an MPO. The IRT's unique design assists the clerk in providing fast, accurate, and efficient service to the patron; however, the IRT is only available at shorebased MPO's. What you have previously learned can be accomplished in a matter of seconds by just pressing one or two keys on the IRT keyboard. Some of the IRT's capabilities include: automatic calculation of domestic and international postage rates; rate comparison between classes of mail; administrative report printing; ZIP Codes to postal zone conversion; and calculation. The IRT is also capable of recording each transaction as it is completed. This recording is an electronic journal of the day's activities.

This system has been designed so that it can be operated with ease. The IRT is an integrated system comprised of three major components: the integrated

module, the customer display, and the receipt printer. Below is a brief explanation of each component:

- **INTEGRATED MODULE**—The integrated module is the system's main component. It contains the electronic scale, clerk display, keyboard, and disk drive. It also houses the central processing unit (CPU) and resident memory. See figure 8-37.
- **CUSTOMER DISPLAY**—This is a seven-inch remote display, which can be placed up to 6 feet from the integrated module. The customer display shows the same information as the clerk's display.
- **RECEIPT PRINTER**—This component is used to print, on demand, both customer receipts and administrative reports. The printer does not have a power switch. It is automatically activated when printing administrative reports or customer's receipts. If you want the printer to print all transactions as you enter them into the system, then you can activate the printer by pressing the PRINT ON/OFF key on the keyboard. The printer has an out-of-paper indicator light and a paper advance button on its front panel. When a new roll of paper needs to be installed, the indicator light goes on, an electronic alarm sounds, and a pop-up printer error window appears on your screen. Use the paper advance button any time you want to advance receipts or blank paper.



## CHAPTER 9

# MAIL HANDLING AND TRANSPORTATION

As a military postal clerk, mail orderly, or mail clerk, you are dealing with that intangible but very important factor in military life, morale. Mail contributes as much to the morale of the military services as any other single factor.

Mail from home is important to your shipmates because it renews their contact with family and friends. Often mail is of great legal or financial significance. You never know when a letter may contain a document or an item of information that will profoundly affect the affairs of the recipient. Therefore, every letter must be handled as if it were of utmost importance.

Working in a post office or unit mailroom will also make you aware that mail is used in logistical support of the operating forces. Naval supply commands forward high-priority parts by mail for ships and aircraft deployed all over the world. Navy exchanges use the mail in overseas areas to provide merchandise for patrons. There is always the official correspondence so vital to the accomplishment of the mission and the well being of the ship's company.

All these considerations serve to focus attention on the handling of mail as one of the most important functions performed at Navy post offices and unit mailrooms.

### DEFINITIONS

---

**Learning Objective:** *Recognize the personnel who handle incoming and outgoing mail and their responsibilities.*

---

This section will deal entirely with mail orderly service and mailroom operations. The definitions of mail handling personnel and facilities are as follows:

- Mail orderly—An individual designated by proper authority to perform mail-handling duties, but who does NOT operate a mailroom.
- Mail clerk—An individual designated by proper authority to do mail duties in association with the operation of a unit mailroom (UMR) or a postal service center (PSC) that is not considered a section of an MPO.

- Unit postal officer—A member or civilian employee of the U.S. Armed Forces, or an employee of a civilian agency, designated by proper authority to supervise the operation of a UMR.
- Unit mailroom—A room or enclosure with proper security that serves as a place for unit mail clerks to handle, process, and deliver mail.
- Serving postal activity—The military or civilian post office that provides postal support.

### MAIL ORDERLY RESPONSIBILITIES

Division/section mail orderlies normally are charged only with the safeguarding and delivery of incoming personal mail. Specific responsibilities of a mail orderly include:

- Delivering personal mail to addressees only
- Placing undeliverable mail in a suitable, securely locked container and delivering it later (as soon as possible) or returning it at the end of the workday to the UMR or serving post office, as applicable
- Returning undeliverable-as-addressed mail to the UMR or serving post office with the reason for nondelivery (TAD, leave, or transferred)
- Reporting any known or suspected postal offenses and irregularities to the unit postal officer or commanding officer

Mail orderlies from the Administrative Department, and at large commands from other departments, have additional responsibility for delivering official mail.

### MAIL CLERK RESPONSIBILITIES

Mail clerks must be designated and properly trained to provide mail service and operate UMRs in accordance with current regulations. Specific responsibilities include:

- Safeguarding mail at all times

- Maintaining an up-to-date mail directory file of all personnel served, due to report, and of personnel who have transferred during the last 12 months (3 months for personnel who were on temporary duty [TAD], or trainees stationed less than 6 months at a training command)
- Performing prompt directory service on all undeliverable-as-addressed mail and returning it to the serving post office as soon as possible, but no later than the following workday after receipt
- Maintaining accountable mail records when provisions are implemented to deliver accountable mail from the unit mailroom
- Correcting all discrepancies noted on mailroom inspections as soon as possible
- Reporting known or suspected postal offenses to the unit postal officer or commanding officer immediately

*Q9-1. Explain the meaning of the term, mail orderly.*

*Q9-2. Define the term unit mailroom.*

Now turn to appendix 1 to check your answers.

## **UNIT MAILROOM OPERATIONS AND MAIL ORDERLY SERVICE**

---

**Learning Objective:** *Recall the structural requirements for unit mailrooms; security requirements for keys, combinations, mail, and mailroom spaces; and the procedures to transport, process, and deliver mail.*

---

Commanding officers must furnish the command mail clerk with mailroom space and equipment as needed for the proper processing and security of the mail. Only essential furniture, mail, and mail records should be kept in mailroom spaces. Mailrooms should be kept in an orderly condition at all times. A notice or sign should be posted showing the hours of operation and times of mail call designated by the commanding officer. This notice or sign should be posted in a prominent place outside the mailroom. An example of the unit mailing address should also be posted in a prominent place outside the mailroom.

## **MAILROOM STRUCTURAL REQUIREMENTS**

Mailrooms must be built in a manner that provides adequate security for the mail and must meet the following requirements:

- Doors must be provided with suitable locks. Door hinges must be mounted inside so the hinges cannot be removed from outside the mailroom.
- Windows easily accessible from the outside must be barred or covered with heavy wire mesh.
- Walls and ceilings must be built of materials that prevent forcible entry.
- Mail receptacles (individual mailboxes), when used, should be installed so that only authorized personnel have access to them.

### **Control of Keys and Combinations**

The keys or combinations to the mailroom, locked containers, safes, or other locked mail receptacles must be in the possession of the senior or other responsible unit mail clerk. Keys must be safeguarded at all times to prevent them from being obtained by unauthorized personnel. Duplicate keys and copies of combinations must be sealed in separate duplicate key envelopes (PS Form 3977). The sealed envelopes must be endorsed to indicate their contents and secured in a safe controlled by the commanding officer or a designated representative. These duplicate keys or combinations must be strictly accounted for. The individual holding the duplicate key or combination and the individual holding the original key or combination must sign across the flap of the sealed envelope. Whenever accountability for combinations or keys change, new envelopes must be prepared.

### **Access to the Mailroom**

The only personnel authorized to enter a UMR are those personnel conducting official business. Proper identification and authorization must be verified before allowing entry. This requirement does not apply to a properly supervised and authorized working party handling closed mails.

### **SECURITY OF MAIL**

Mail clerks and mail orderlies may be held liable for any loss caused by their failure to handle mail properly.

Mail-handling areas and all receptacles for accountable mail (registered, Express Mail, numbered insured, and certified) must be locked when the responsible individual(s) are not physically present. While mail is in the custody of mail clerks or mail orderlies, it must not be subject to delay, interception, seizure, rifling, or confiscation by any person. Mail clerks and mail orderlies must deliver mail only to the addressee or an agent designated in writing by the addressee. Unit mailrooms that store official registered mail overnight must have a GSA approved security container that is properly secured to prevent easy removal or the mailroom must meet the requirements for storing classified material.

## **TRANSPORTING MAIL**

A closed body vehicle equipped with lockable doors must be used to transport mail to and from mail service areas. If such a vehicle is unavailable and another kind is used, mail clerks and mail orderlies should ride in the compartment that holds the mail. If conditions prohibit personnel from riding in the compartment with the mail, visual contact should be maintained with the mail at all times. Privately owned vehicles will not be used to transport mail. If an abnormal situation occurs where a privately owned vehicle must be used, approval must first be obtained from the Commanding Officer. All mail except outside pieces (OSPs) should be transported in USPS mailbags.

## **DELIVERY OF ORDINARY MAIL**

Personal mail should be delivered to the addressee through the use of individual mail receptacles or by using the mail orderly system. When the mail orderly system is used, check the member's DD Form 285 and verify it against the member's ID card.

The mail orderly system is the most common method used by overseas shore activities and ships. Mail orderlies pick up mail for their department or division and redistribute the mail to the addressee. Under no circumstances should they place mail on bunks or tables, in open boxes, or similar places, or otherwise leave mail unprotected while awaiting delivery. Undelivered mail must be stowed in securely locked containers or spaces for future delivery to the addressee(s) or returned to the MPO or UMR for safekeeping. Mail orderlies must print and sign their name on a suitable log or sheet when they pick up mail for their activity. The log should also show the name of the activity and the date and time the mail was picked up (see figure 9-1).

These general guidelines should be followed when accepting, processing, and delivering mail:

- Before receipting for mail at the serving postal activity, mail clerks and mail orderlies must ensure that damaged articles are properly endorsed and the articles are repaired or rewrapped, if necessary. If damaged articles are received in closed bags; unit mail clerks must repair the articles and endorse them, **DAMAGED IN HANDLING IN THE POSTAL SERVICE**. The date of receipt and identity of the unit that made the repairs should also be endorsed on the articles.
- Mail suspected of containing harmful matter must be immediately reported to a supervisor.
- Mail addressed to unit members by title (commanding officer, administrative officer, and so forth) is considered official mail, and must be delivered through official mail channels.
- Mail addressed in care of another person or addressed to more than one addressee may be delivered to any addressee listed in the address.
- At shore activities a competent member of the family who has a valid ID card may be given mail addressed to the family, except mail items reflecting restricted delivery. However, the sponsor may state in writing that no member, other than the sponsor, should have access to the mail.
- Registered mail received as ordinary mail must be returned to the registry section of the serving post office. PS Form 3877 is prepared in duplicate and modified for the return of registered mail with the endorsement, **FOUND IN ORDINARY MAIL AT** (location), placed on the front of the bill (see figure 9-2).
- Other accountable mail, such as insured and certified received as ordinary mail must also be returned to the serving post office for proper accountability.
- C.O.D. service is not available in the military postal service. C.O.D. mail will be returned to the serving post office for processing.
- Postage-due mail will be delivered as regular mail without the collection of postage.
- Mail opened by mistake must be resealed, endorsed **OPENED BY MISTAKE**, and signed by the person who opened the mail. The mail

**USS UNDERWAY CV-66  
MAILCALL SHEET**

**DATE:**

<b>DIVISION</b>	<b>CARD #</b>	<b>TIME</b>	<b>PRINT NAME</b>	<b>SIGNATURE</b>
<b>ADMIN</b>				
<b>STAFF ADMIN</b>				
<b>AIR</b>				
<b>MEDICAL</b>				
<b>DENTAL</b>				
<b>S-1</b>				
<b>S-2</b>				
<b>S-3</b>				
<b>S-4</b>				
<b>S-5</b>				
<b>NAVIGATION</b>				
<b>COMM</b>				
<b>OI</b>				
<b>WEAPONS</b>				
<b>DECK</b>				
<b>A</b>				

**Figure 9-1—An example of a command mailcall sheet.**

will be returned to the serving post office, so it can be forwarded to the correct addressee.

- Balloting material must be given priority handling and delivered as quickly as possible.
- Articles refused by the addressee must be endorsed REFUSED, along with the addressee's signature and date. If the addressee refuses to make the endorsement, the mail clerk or mail orderly must endorse the article REFUSED BY ADDRESSEE, and date and sign the article.
- Stamps found loose in the mails must be returned to the serving post office.
- Every effort must be made to match articles found loose in the mail. Articles not matched must be returned to the serving post office.

**DELIVERY OF OFFICIAL  
ACCOUNTABLE MAIL**

A unit mail clerk or mail orderly (if authorized) receipts for official accountable mail from the serving post office. The serving post office uses PS Form 3883, preparing an original and one copy of the form. The original remains at the post office and the copy is taken to the mailroom with the official accountable mail or given to the mail orderly.

Before receipting for official accountable mail, the unit mail clerk or mail orderly should make certain that all articles listed are received. Articles should be checked to ensure they are in good condition and have not been tampered with. If the wrappers or contents are damaged or torn, the serving

**NETPDTC**  
**PENSACOLA FL 32509**

**Name and Address of Sender**      **Address Name, Street, and PO Address**

**Check type of mail:**  
 Express     Return Receipt (RR) for Merchandise  
 Registered     Certified  
 Insured     Int'l Rec. Del.  
 COD     Del. Confirmation (DC)

**If Registered Mail, check below:**  
 Insured     Due Sender If COD  
 Not Insured

**Postmark and Date of Receipt**

Line	Article Number	Addressee Name, Street, and PO Address	Postage	Fee	Handling Charge	Actual Value (If Reg.)	Insured Value	DC Fee	SC Fee	SH Fee	SD Fee	RD Fee	Remarks
1	RR141002111US	23511											
2													
3													
4													
5													
6													
7		FOUND IN ORDINARY MAIL AT											
8		NETPDTC MAIL ROOM											
9		PENSACOLA FL 32509											
10													
11													
12													
13													
14													
15													
Total Number of Pieces Listed by Sender		Total Number of Pieces Received at Post Office		Postmaster, Per (Name of receiving employee)									
- 1 -													

**Complete by Typewriter, Ink, or Ball Point Pen**

PS Form 3877, April 1999

PCF0902

Figure 9-2.—An example of a modified PS Form 3877 for the return of registered mail found in the ordinary mail at a unit mailroom.

post office should repair the mailing containers or rewrap the articles, place the endorsement, **DAMAGED IN HANDLING IN THE POSTAL SERVICE**, on the mail, and annotate on the delivery bill that the article(s) were damaged. If damaged articles are received in closed bags, they should be repaired and endorsed, **RECEIVED IN DAMAGED CONDITION**, along with the date of receipt and the identity of the unit repairing the article.

Before official accountable mail is signed for by department or division mail orderlies from a unit mail clerk, the accountable mail must be listed on a PS Form 3883 by identifying numbers and office of origin. Whenever a mail clerk releases control of official accountable mail to a department or division mail orderly, proper receipting procedures must always be followed to ensure accountability. Accountable official mail must be covered by a chain of receipts from the time the mail is accepted by unit mail clerks until delivery has been made to the appropriate mail orderly. If the mail clerk or mail orderly has the commanding officer's authority to open official mail, it is considered to be delivered once receipted for at the serving post office or UMR and no further transfer receipts are required. Unit mail clerks must return all undeliverable-as-addressed accountable mail to the serving post office on PS Form 3877 prepared in duplicate. The accepting postal clerk will sign for the accountable mail and keep the original PS Form 3877 for records purposes. The unit mail clerk must keep the signed copy of PS Form 3877 for mailroom records. The PS Form 3877 is annotated to show the disposition of the returned article (see figure 9-3).

## **DELIVERY OF PERSONAL ACCOUNTABLE MAIL**

Personal accountable mail should be delivered by the serving post office to the addressee or an authorized agent. The serving post office should provide the unit mail clerk or mail orderly with a PS Form 3849, which will be given to the addressee when the mail is delivered.

### **Delivery of Personal Accountable Mail from a Mailroom**

If a unit is geographically isolated from the serving post office, commanding officers may authorize mail clerks to receipt for and deliver personal accountable mail. This authority must be in writing and kept on file at the UMR, with a copy provided to the serving post office. Once this authority is granted the responsibility to prepare and maintain PS Form 3849 will also be

transferred to the unit. Personal accountable mail will then be delivered to unit mail clerks by the serving post office using a PS Form 3883 as a delivery receipt.

When personal accountable mail is received from the serving post office, the unit mail clerk must:

- Use PS Form 3849 to notify customers of their accountable mail. The form is prepared the day the article is received and delivered with the ordinary mail.
- Annotate the article with the date the notice was prepared, and store the article separately from nonaccountable mail.
- Require positive identification of the addressee or authorized agent before delivering the accountable mail. An ID card or U.S. passport that identifies the bearer by photograph and signature is acceptable.
- Obtain the addressee's or authorized agent's signature on PS Form 3849 before delivering the article. If a return receipt, PS Form 3811 or PS Form 2865, is attached to accountable mail, it must also be signed and dated by the addressee. The return receipt should be returned promptly to the sender.
- Date and sign PS Form 3849 and file the form. PS Form 3849s are filed numerically by the last two digits of the identifying article number and retained for 2 years. The forms are filed in a single file. However, a separate file may be used for forms used to deliver registered articles if there are a large number of forms to retain.

### **Retention Period for Accountable Mail**

When accountable mail has not been called for after 5 days (3 days for Express Mail) from initiating PS Form 3849, prepare a second PS Form 3849, and send the second notice to the addressee. On the article next to the first endorsement, annotate the date the second notice was prepared. If the article has not been called for after 10 days from the second notice (2 days for Express Mail), you should verify the addressee's status through the respective department or division. Based on the information received:

- Endorse the article with the correct forwarding address if available, or endorse it with the **RETURN TO SENDER** stamp. If there is a return receipt attached to the article, ensure it remains attached to the article.

**Name and Address of Sender**  
 NETPDTC  
 PENSACOLA FL 32509

**Check type of mail:**  
 Express  
 Registered  
 Insured  
 COD

**Return Receipt (RR) for Merchandise**  
 Certified  
 Int'l Rec. Del.  
 Del. Confirmation (DC)

**If Registered Mail, check below:**  
 Insured  
 Not Insured

**Postmark and Date of Receipt**

Line	Article Number	Addressee Name, Street, and PO Address	Postage	Fee	Handling Charge	Actual Value (If Reg.)	Insured Value	Due Sender If COD	RR Fee	DC Fee	SC Fee	SH Fee	SD Fee	RD Fee	Remarks
1	RR141002111US	CO, USS UNDERWAY (CV-66)													
2		FPO AE 09561 - 0001													FWD
3															
4															
5															
6															
7															
8															
9															
10															
11															
12															
13															
14															
15															

**Total Number of Pieces Listed by Sender** - 1 -

**Total Number of Pieces Received at Post Office**

**Postmaster, Per (Name of receiving employee)**

**Complete by Typewriter, Ink, or Ball Point Pen**

PS Form 3877, April 1999

PC10903

Figure 9-3—A sample of a PS Form 3877 for the return of undeliverable registered mail to the serving post office from the unit mailroom.

- Prepare a PS Form 3849 showing disposition of the undeliverable accountable article on the reverse side of the form and sign and date the form.
- File the completed PS Form 3849 and return the undeliverable article to the serving post office using PS Form 3877 (see figure 9-3).

**RESTRICTED DELIVERY**

The sender at the time of mailing may direct registered, certified, and numbered insured articles be delivered only to the addressee or to someone named by them in writing. The endorsement RESTRICTED DELIVERY is used for this purpose. Other markings such as PERSONAL are not to be considered as indicating restricted delivery services.

Addressees can authorize other individuals to receive their mail, including restricted delivery mail, by completing a PS Form 3801, Standing Delivery Order, (see figure 9-4) at the serving MPO.

**STORAGE OF ACCOUNTABLE MAIL AWAITING DELIVERY**

You should store accountable mail in a manner that allows easy retrieval when it is called for by an

addressee with the exception of registered mail, which should be kept in a secure area away from other mail. The volume of mail and the amount of floor space in your mailroom will normally dictate a workable system for your situation. All accountable mail should be stored in a manner that allows easy and quick monitoring during retention periods and for follow-up action with PS Form 3849 as previously discussed.

- Q9-3. *Mailrooms ashore must be built to provide adequate security for all mail. (True/False)*
- Q9-4. *In what manner must you account for duplicate keys and copies of safe combinations?*
- Q9-5. *What official's permission must you obtain before picking up mail in a private vehicle?*
- Q9-6. *What is the most common system used in the Navy to deliver mail to the addressee?*
- Q9-7. *What is the maximum amount of postage due, if any, that should be collected on an article addressed for delivery at an MPO?*
- Q9-8. *When official accountable mail is receipted for by department or division mail orderlies from a unit mail clerk, the mail should be listed and signed for on what PS form?*

<b>Name and Address of Firm or Individual (Include Apt./Suite No.)</b>	
CAPT VERY C. PISTOL, U.S. NAVAL AIR STATION, FPO AP 96454	
<b>By (Signature and title of person signing order)</b>	<b>Telephone No.</b>
<i>Very C. Pistol, CAPT USA1</i>	458-1707
<p>The above-named firm or individual hereby authorizes representatives whose signatures appear below to receive unrestricted registered, certified, insured, c.o.d., express mail, and special delivery mail addressed to or in care of the above-named firm or individual until otherwise notified in writing, and assumes all responsibility for loss, rifling, or damage of said mail after proper delivery. All previous orders are hereby revoked. SPECIAL INSTRUCTIONS: Where RESTRICTED DELIVERY MAIL is to be included, the statement "This authorization is extended to include RESTRICTED DELIVERY MAIL" must be entered on the delivery order by the person signing it. This notation is to be made on the part of the form for signatures of authorized agent. NOTE: Unknown signatures must be identified.</p>	
<b>Signature of Clerk Verifying Customer's Signature</b>	<b>Date</b>
<i>Abbe B Seaman PCSN</i>	9/3/00
<b>SIGNATURES OF AUTHORIZED AGENTS</b>	
GS-9 JANE FROST	<i>Jane Frost</i>

PS Form 3801, Apr. 1983

**STANDING DELIVERY ORDER**

PCf0904

Figure 9-4.—An example of a PS Form 3801, Standing Delivery Order.



*Q9-9. Personal accountable mail should be delivered using what PS form?*

Now turn to appendix 1 to check your answers.

## **SHIPBOARD AND OVERSEAS MPOS**

---

**Learning Objective:** *Recall the procedures for processing incoming mail at a shipboard or overseas MPO.*

---

Aboard ship and at overseas MPO's your duties as a military postal clerk will involve the actual handling, sorting, and distribution of all incoming mail. If you are aboard ship and are in a United States port of call, you will pick up your mail at the local civilian post office. If your ship is in a foreign port overseas, the mail is usually received through the nearest MPO or FMC. If there is no U.S. military post office in the area, you will receive your mail from a commercial air carrier, military air carrier, local foreign post office, U.S. Embassy or Consulate.

When your ship is at sea, you may receive mail by highline, carrier onboard delivery (COD), or helicopter. Highline is the oldest method used to transfer articles from one small ship to another; this method is referred to as underway replenishment. The COD brings cargo, mail, and passengers to the aircraft carrier. Some of the cargo and mail will be for other ships that are operating with the carrier. The carrier must either use highline or helicopter to transfer cargo, mail, and passengers to the other ships. Also, the ships in company with the carrier send their outgoing mail, cargo and passengers to the carrier so they can be put aboard the COD for further transfer ashore.

Although you will find some of the explanations and procedures in this section to be repetitive, you must look at them in the context of operating within a different environment—shipboard and overseas military post offices.

## **MILITARY ORIGIN DESTINATION INFORMATION SYSTEM (MODIS)**

Before sorting and delivering incoming mail, or transferring mail to ships of a battle group, overseas postal activities and ships on deployment must record transit time data from bar-coded labels attached to priority mail pouches and OSPs, and from labels on trays containing First-Class letter mail. Overseas shorebased postal activities must also record data from

bar-coded labels attached to Express Mail articles addressed for delivery to overseas shore installations.

MODIS is the system used to measure transit times. Postal clerks use the system, which consists of handheld computers and laser scanners to scan the bar-coded labels. When the scanning has been completed for the day, the scanned bar-code data is transmitted via Streamlined Automated Logistics Transmission System (SALTS) to SALTS central located at the Naval Inventory Control Point in Philadelphia, PA.

The purposes of collecting transit time data are to accomplish the following:

- Measure USPS, air carriers, and DOD performance in the movement of military mail
- Monitor mail movement
- Assess transit times
- Identify the inefficient or misrouting of mail
- Make recommendations to mail routing authorities to correct mail movement problems or errors

MODIS scanning is required each time mail is received, whether the mail is for your command or is mail you have received for further transfer. Before scanning mail, verify the set-up data is correct and ensure the laser scanner is not pointed in a way that would do harm to your eyes or the eyes of other personnel in the post office.

Postal clerks assigned to ships receive MODIS training by the appropriate FLTCINC postal officer before deployment. This training consists of how to correctly scan mail, download the data, and transmit it to SALTS central. At overseas postal activities, the postal officer is responsible for providing the training. Postal clerks can also refer to the MODIS User Guide for the correct operation of MODIS equipment.

The command postal officer is responsible for ensuring the MODIS equipment is accounted for, maintained in operating condition, and safeguarded. If the equipment becomes damaged, the postal officer must investigate the reason for the damage and report the circumstances to the FLTCINC postal officer. As the person using the equipment on a daily basis, you must keep the postal officer informed at all times of the status of MODIS equipment and report any problems to him or her so corrective action can be taken. It may also be necessary to return equipment for repair or replacement.

Other responsibilities of the postal officer include referring to the MODIS User Guide for the correct operation of MODIS equipment (if necessary), contacting SALTS help desk with problems related to SALTS, and contacting the FLTCINC postal officer regarding problems that cannot otherwise be resolved. The postal officer should also review the daily dispatch report generated from the data submitted to SALTS. Review of this report may identify inefficient routing of mail, which can be reported to the appropriate mail routing authority so corrective action can be taken. As the postal expert for your command, you should become knowledgeable of all aspects of the MODIS system. Your command postal officer will rely on you to ensure the success of the program.

### **DELIVERY OF INCOMING MAIL**

Now that you have scanned the bar-coded labels on incoming mail, you are ready to process the mail for final delivery.

Incoming mail may be separated and delivered by departments, divisions, and by general delivery. Your ship or overseas station's personnel complement will determine the number of separations required for incoming mail.

Arrange the letter case to permit rapid sorting of the mail. When compartments of the letter case are assigned, reserve those that are easily accessible for departments or divisions that receive the largest volume of mail.

### **GENERAL DELIVERY SERVICE**

At overseas locations, dependents may be provided general delivery service when they are separated from their sponsor because of a military situation. At overseas locations, where mail receptacles are not used for the delivery of personal mail, retirees authorized MPO privileges may also receive mail through the general delivery system, subject to base or status of forces agreements (SOFA).

### **SORTING MAIL**

As you sort mail, the following guidelines apply:

- Set aside all Express, certified, and numbered insured mail to prepare PS Form 3849. NOTE: Express Mail can only be received at overseas shorebased activities.

- Postmark all missent letters and flats with the date of receipt on the back of the article and endorse "Missent to MPO \_\_\_\_." Postmark parcels and publications on the address side. Then forward the articles to the correct address with the next outgoing dispatch.
- When a piece of mail reaches your office without postage fully prepaid at the time of mailing, you must deliver the piece without collecting the postage-due. This includes any deficient postage on a piece for which special services have been requested.
- If registered mail is received in ordinary mail, follow the guidelines discussed in chapter 7.
- Mail received for delivery to individuals or activities not authorized MPO privileges will be returned to the sender endorsed ADDRESSEE NOT AUTHORIZED MPO PRIVILEGES.

### **SORTING INCOMING PARCELS**

When you sort parcels, be sure you separate the numbered insured parcels from the ordinary and unnumbered insured parcels. Unnumbered insured parcels are treated as ordinary mail and should be delivered as ordinary mail.

### **DELIVERY OF ACCOUNTABLE MAIL**

Personal accountable mail should be delivered by the military post office to the addressee or an authorized agent. Delivery is completed by preparing PS Form 3849 in the same manner discussed earlier in this chapter.

Official accountable mail addressed to the commanding officer, supply officer, and so forth, should be receipted for on a PS Form 3883. The articles should then be delivered directly to a unit mail clerk, or mail orderly authorized on DD Form 285.

### **DISPOSITION OF DAMAGED MAIL**

All damaged mail, with the exception of registered mail enclosed in pouches, should be endorsed DAMAGED IN HANDLING IN THE POSTAL SERVICE. Damaged registered mail received in closed pouches should be endorsed RECEIVED IN DAMAGED CONDITION. Mail matter damaged as a result of a catastrophe should be repaired and a letter of explanation outlining the circumstances that led to the damage must be enclosed in each repaired article, and

the article forwarded under priority USPS indicia to the addressee.

## **ARTICLES FOUND LOOSE IN THE MAILS**

You will occasionally find stamps, money, or other articles loose in a mail pouch. You should make every effort to match loose articles with the mailing container(s) from which they were lost. When an article of value cannot be matched with an addressed envelope or wrapper, examine the article to try to determine the sender. If you can determine the sender, return the article in a USPS official indicia envelope or in another container with a USPS label affixed. Enclose a letter of explanation. For articles that cannot be matched with wrappers and/or ownership cannot be established, then the following handling procedures apply:

- Articles of minor value, such as pens, pencils, and stationery, should be given to the chaplain or other official designated by the commanding officer for disposition.
- Articles such as food, drugs, tobacco products, toothpaste, and cosmetics and articles contained in parcels with the mailer's instructions to abandon if undeliverable should be destroyed.
- Articles of obvious value (including money) should be forwarded by registered USPS indicia mail to the appropriate accountable postmaster.

## **UNCANCELED STAMPS FOUND LOOSE IN MAIL**

Every effort should be made to reattach loose stamps to the mail if possible; if not, they should be destroyed by a military postal supervisor.

## **IRREGULARITIES**

As you process mail, watch for irregularities in the makeup and dispatch made by other military post offices or the USPS. If irregularities (discrepancies) are discovered, an irregularity report must be completed. Report mail irregularities by preparing a DD Form 2273, Irregularities in Makeup and Dispatch of Mail (see figure 9-5). Irregularities may include, but are not limited to:

- Missent mail
- Improper tag or label
- Improper slide label

- Mail discovered in empty equipment
- Mail dispatched in defective equipment
- Mail transported in wrong mail transport equipment (MTE) for its class

When reporting irregularities, the postal clerk will remove the slide label from the sack, pouch or tray involved and attach it to the DD Form 2273. This will assist in isolating errors and speeding up corrective action. Prepare DD Form 2273 in an original and two copies, and distribute as follows:

If irregularities are between MPOs:

- Send the original to the appropriate postal commander or postal officer (attach the slide label, facing slip (if any), and tag to the report)
- Send one copy to your major command headquarters
- Retain one copy for your MPO file

If USPS errors are noted:

- Send the original to the appropriate Joint Military Postal Activity (JMPA). Attach the slide label, facing slip (if any), and tag to the report.
- Send one copy to your major command headquarters.
- Retain one copy for your MPO file.

Follow the instructions given below to prepare DD Form 2273. Report only one irregularity per form.

Block 1. Enter the date the irregularity is discovered (YY/MM/DD).

Block 2. If an irregularity is between MPOs, address DD Form 2273 to the commander or postal officer of the dispatching activity and enter the address from the bottom line of slide label (the address of the post office or activity at fault).

If USPS error, then address it to the appropriate JMPA. Send the report as follows:

From APO/FPO 09XXX and 34XXX addresses

COMMANDER  
JOINT MILITARY POSTAL ACTIVITY -  
ATLANTIC  
ISC-JFK BLDG 250 ROOM MF-35  
JAMAICA NY 11430-9201

From APO/FPO 96XXX addresses

COMMANDER  
 JOINT MILITARY POSTAL ACTIVITY - PACIFIC  
 INTERNATIONAL SERVICE CENTER  
 2650 BAYSHORE BLVD  
 DALY CITY CA 94013-0026

Block 3. Enter the address of the MPO preparing the report.

Block 4. Enter the postal activity that dispatched the mail (bottom line of slide label). For mail received from military post offices, this will be the APO or FPO number.

Block 5. Enter the date the mail was dispatched (see reverse side of slide label).

Block 6. Enter the class or type of mail involved. For example, First-Class (or FCM), Priority, Standard mail, SAM, PAL, etc.

Block 7. Enter the number of slide labels or facing slips attached to the report.

Block 8. Indicate the irregularity by checking the appropriate box. More than one box may be checked.

For example, if a pouch or sack was the wrong type and unserviceable, then you'll mark both boxes.

Block 9. Write a concise explanation of the irregularity to include any irregularity discovered which is not mentioned on the form.

Block 10. Enter name (Last, First, MI), paygrade, and sign.

Q9-10. What PS form should you use to obtain the signature of an addressee for delivery of a certified letter?

Q9-11. While sorting incoming letter mail, what should you do when you discover a missent letter?

Q9-12. When a letter is received at your MPO addressed to an individual or activity not authorized MPO privileges, what necessary action must occur?

Q9-13. Explain the procedures to follow when loose cash is found during the sorting of incoming or outgoing mail.

IRREGULARITIES IN MAKEUP AND DISPATCH OF MAIL <i>(For use of this form see DOD 4525.6M)</i>			1 DATE (YYYYMMDD)
2 TO <i>(Use complete address)</i>		3 FROM <i>(Use complete address)</i>	
4 MAIL DISPATCHING ACTIVITY <i>(Dispatched from)</i>		5 DATE OF DISPATCH (YYYYMMDD)	6 MAIL CLASSIFICATION
		7a NO. SLIDE LABELS	<input type="checkbox"/>
		b NO. FACING SLIPS ATTACHED	<input type="checkbox"/>
8. POUCH/SACK <i>(Attach slide label)</i>		9. FACING SLIP <i>(Attach with slide label)</i>	
<input type="checkbox"/> WRONG TYPE <input type="checkbox"/> UNSERVICEABLE <input type="checkbox"/> IMPROPERLY SEALED		<input type="checkbox"/> MISSING <input type="checkbox"/> INCORRECT <input type="checkbox"/> IMPROPERLY PREPARED	
10. LETTER TIES <i>(Attach slide label &amp; facing slip)</i>		11. PRESSURE SENSITIVE LABEL <i>(Attach slide label)</i>	
<input type="checkbox"/> BROKEN <input type="checkbox"/> LOOSE <input type="checkbox"/> DIRECTS NOT MADE		<input type="checkbox"/> MISSING <input type="checkbox"/> INCORRECT	
12. OUTSIDE MAIL, PS Label 136		13. CODED TAG <i>(Attach slide label)</i>	
<input type="checkbox"/> MISSING <input type="checkbox"/> INCORRECT <input type="checkbox"/> IMPROPERLY PREPARED		<input type="checkbox"/> MISSING <input type="checkbox"/> INCORRECT <input type="checkbox"/> IMPROPERLY PREPARED <input type="checkbox"/> ALTERED	
14. SLIDE LABEL <i>(Attach)</i>		15. MAIL ROUTED INCORRECTLY <i>(Attach slide label &amp; facing slip)</i>	
<input type="checkbox"/> MISSING <input type="checkbox"/> INCORRECT <input type="checkbox"/> IMPROPERLY PREPARED <input type="checkbox"/> ALTERED		<input type="checkbox"/> LETTER(S) <input type="checkbox"/> PARCEL(S)	
16. REMARKS <i>(Explain each irregularity to include any discovered that are not mentioned above)</i>			
9			
17a. TYPED/PRINTED NAME OF REPORTING OFFICIAL <i>(Last, First, Middle Initial)</i>		b. PAY GRADE	c. SIGNATURE

DD FORM 2273, MAY 2000      PREVIOUS EDITION IS OBSOLETE.

10

Figure 9-5.—An example of a DD Form 2273, Irregularities in Make-up and Dispatch of Mail.

*Q9-14. What form should be used to report mail received by your MPO that was dispatched in defective equipment?*

Now turn to appendix 1 to check your answers.

## **TREATMENT OF INCOMING INTERNATIONAL MAIL**

---

**Learning Objective:** *Recall the procedures for processing incoming international mail.*

---

The delivery of international mail received in your office is documented and delivered in the same manner as domestic mail. This section will help you identify special service endorsements on incoming international mail, with the exception of registration, which was covered in chapter 7 of this training manual.

### **SPECIAL DELIVERY**

Incoming items prepaid for special delivery should bear a label, printed in red, or on a red background, containing the word EXPRES or the notation SPECIAL DELIVERY in bold letters. Incoming special delivery items should be delivered in the same manner as ordinary domestic mail.

### **INSURED PARCELS**

In determining whether a parcel is insured, one of the following insurance endorsements must appear on the parcel according to the language of the country of origin:

- INSURED
- ASEGURADO or VALOR DECLARADO
- ASSICURATO or VALOR DICHIARATO
- VALEUR DECLAREE or VD
- WERTANGABE or WERTPAKET

A number on a parcel is not sufficient evidence of insurance. An insurance endorsement is required to indicate that the article is insured. You should deliver international insured parcels in the same manner as domestic numbered insured parcels.

### **RETURN RECEIPTS**

Return receipts from other countries bear the words AVIS DE RECEPCION or the letters AR. When your office receives international mail with a return receipt attached you should:

- Request the addressee or authorized agent date and sign the receipt in INK. When signed by an agent

of the addressee, have the agent sign the addressee's name, followed by the agent's own signature.

- Postmark the receipt in the appropriate spaces on both sides.
- Endorse the completed receipt AIRMAIL and dispatch in the next outgoing mail.

When incoming registered or insured mail is marked AR or bears the notation AVIS DE RECEPCION but is not accompanied by a return receipt, the delivery office must complete and attach an international return receipt PS Form 2865.

## **MAIL LOGS AND EQUIPMENT**

---

**Learning Objective:** *Recall procedures for completing mail logs and handling surplus mail transport equipment (MTE).*

---

The maintenance of postal records and logs is a very important phase in the operation of any post office. These records are necessary to determine the adequacy of mail service and to assist in cases of complaints or investigations. They must be readily available during postal inspections.

### **INCOMING AND OUTGOING MAIL LOGS**

A record of all incoming and outgoing mail received at and dispatched from your post office should be kept on file. The standard Navy record logbook with columns for appropriate entries is the easiest log to maintain and should be retained for 6 months after the last entry (see figure 9-6).

If you compile receipt and dispatch information daily, you will have a record of the weight and classes of mail handled by your MPO.

As you remove slide labels from incoming mail pouches, sacks, and trays, set them aside until you finish sorting the mail. This is necessary in the event discrepancies are noted. Open and sort the contents of pouches, sacks, or trays one at a time. If you do not discover any discrepancies, you can destroy the labels.

### **MAIL TRANSPORT EQUIPMENT (MTE)**

The amount of mail received and dispatched by your post office determines the frequency of return dispatches of serviceable MTE. MTE is any sack, pouch, letter or flat tray, etc., that is used for the transport of U.S. mail. Any serviceable sack, pouch or

INCOMING MAIL: APRIL

DATE	RECEIVED FROM	LETTER	PRIORITY	MOM	SAM/PAL	REG	SURFACE	LOCATION	REMARKS
1	FMC YOKOHAMA GMF SFRAN	1/16.9 4/20.3	— 6/150.0	1/5.5 2/28.4	— 2/360.5	— 2/20.6	— —	MPO YOKOSUKA INPORT	—
2	GMF SFRAN FMC YOKOHAMA	2/40.1 1/2.3	4/100.3 —	4/1.1 —	3/166.1 —	4/12.4 1/2.0	— —	USS NIMITZ AT SEA	—
3	NO MAIL RECEIVED								HELD RECD FROM NIMITZ NO MAIL
4	GMF SFRAN	2/30.5	3/10.1	1/35	6/120.2	—	—	HELD FROM USS NIMITZ	NO MANIFEST

OUTGOING MAIL: APRIL

DATE	DISPATCHED TO	LETTER	PRIORITY	MOM	SAM/PAL	REG		LOCATION	REMARKS	
1	98762 GMF SFRAN	1/3.5 2/20.1	— 6/150.4	— 4/10.8	— 13/265.1	1/2 3/65.4		INPORT YOKOSUKA	LOCAL FORCES —	
2	98762 GMF SFRAN	1/8.4 1/12.8	— 10/250.1	— 2/45.4	— 20/605.4	1/5 2/32.1		INPORT YOKOSUKA	LOCAL FORCES —	
3	NO MAIL DISPATCHED								AT SEA	HELD DID NOT TAKE OUTGOING MAIL
4	GMF SFRAN USS NIMITZ	2/40.6 1/3	1/19.5 —	— —	2/67.4 —	— 1/7		USS NIMITZ HELD	LOCAL FORCES	

PCF0906

Figure 9-6—Examples of incoming and outgoing mail logs.

tray is considered excess equipment unless actually needed for the dispatch of mail. Do not hold MTE for possible emergencies.

Q9-15. In what manner should international mail be delivered after it is received at your MPO?

Q9-16. A number on a parcel is not sufficient evidence of insurance. An insurance endorsement is required to indicate that the article is insured. (True/False)

Q9-17. What is the purpose of incoming and outgoing mail logs?

Now turn to appendix 1 to check your answers.

## OUTGOING MAIL

---

**Learning Objective:** *Recall the procedures for collecting and preparing outgoing mail for dispatch.*

---

Now we will cover procedures for the processing and makeup of outgoing mail at all MPOs. The processing and makeup of mail is the first and most important step in the mail delivery cycle. This phase of operation involves the following:

- Collecting raw mail
- Facing the mail
- Postmarking the mail
- Sorting the mail
- Pouching the mail
- Traying letter mail or First-Class flats
- Labeling pouches, letter mail, and flat trays

By following the proper procedure for the above tasks, you will prevent unnecessary delay of the mail.

## FACILITIES FOR MAIL DEPOSIT

---

**Learning Objective:** *Recall the recommended locations for placement of mail collection boxes, their construction, and security requirements.*

---

If at all possible, you should not require persons to bring outgoing letter mail to the post office. Aboard ship, collection boxes should be installed in various spaces such as the crew's living quarters, general mess, library, CPO mess, wardroom, or any other area convenient for crewmembers. At shore activities, street-type collection boxes are placed in high-traffic areas that are easily accessible to the greatest number of personnel. One box should be placed outside, in front of the post office. Other boxes may be placed in housing areas, near the galley, BOQs and BEQs, exchange, and so forth.

In addition to collection boxes, you should have a letter drop inside the station post office. It should be located in a convenient place for your customers and for you when sorting, canceling, and casing mail. For

example, if your post office mail drop were directly below one of your finance windows, it would be inconvenient to everyone. The mail drop should be low enough and the slot made in such a way as to protect the mail and prevent it from being taken back out through the slot.

## COLLECTION BOXES

Collection boxes aboard ship are usually supplied by Commander, Naval Sea Systems Command (COMNAVSEASYS COM), in the initial commissioning allowance. If, for any reason, the standard issue letter collection boxes are not available, or if you require additional collection boxes, it may be necessary to have them constructed.

Sheet metal is the best material to use in the construction of collection boxes. With slight modification, some containers can be good substitutes for the standard collection box.

When designing collection boxes for your ship, you might pattern them after the collection boxes used by the USPS (see figure 9-7). The design need not be elaborate to be functional. A slot approximately 1 1/2 inches wide by 11 inches long will accommodate most letters, flats, and film mailers.

When installing collection boxes, make sure they are secured in such a way as to discourage attempts to remove them. On board ship, the bolts holding the collection box may be welded to the bulkhead with nuts inside the box. This way the box must be open to remove the nuts from the bolts.

## LOCKING DEVICES FOR COLLECTION BOXES

A government issue (GSA), three position-tumbler, series-type lock is the best for collection boxes. You can requisition this type of lock in quantities of 8 or 12, with a key for each lock and one master key that will open all the locks in the series. One good security feature of this type of lock is that the key cannot be removed until the lock is secured. This prevents the possibility of leaving the collection box unlocked when you pick up the mail. If, for some reason, you cannot obtain the GSA series-type lock, any three position-tumbler type of lock will be adequate until you can acquire the GSA series-type lock.

If you are the COPE for your post office, you are always responsible for the keys of your post office and collection boxes. Keys to collection boxes should be placed in a secure area when the keys are not in use.

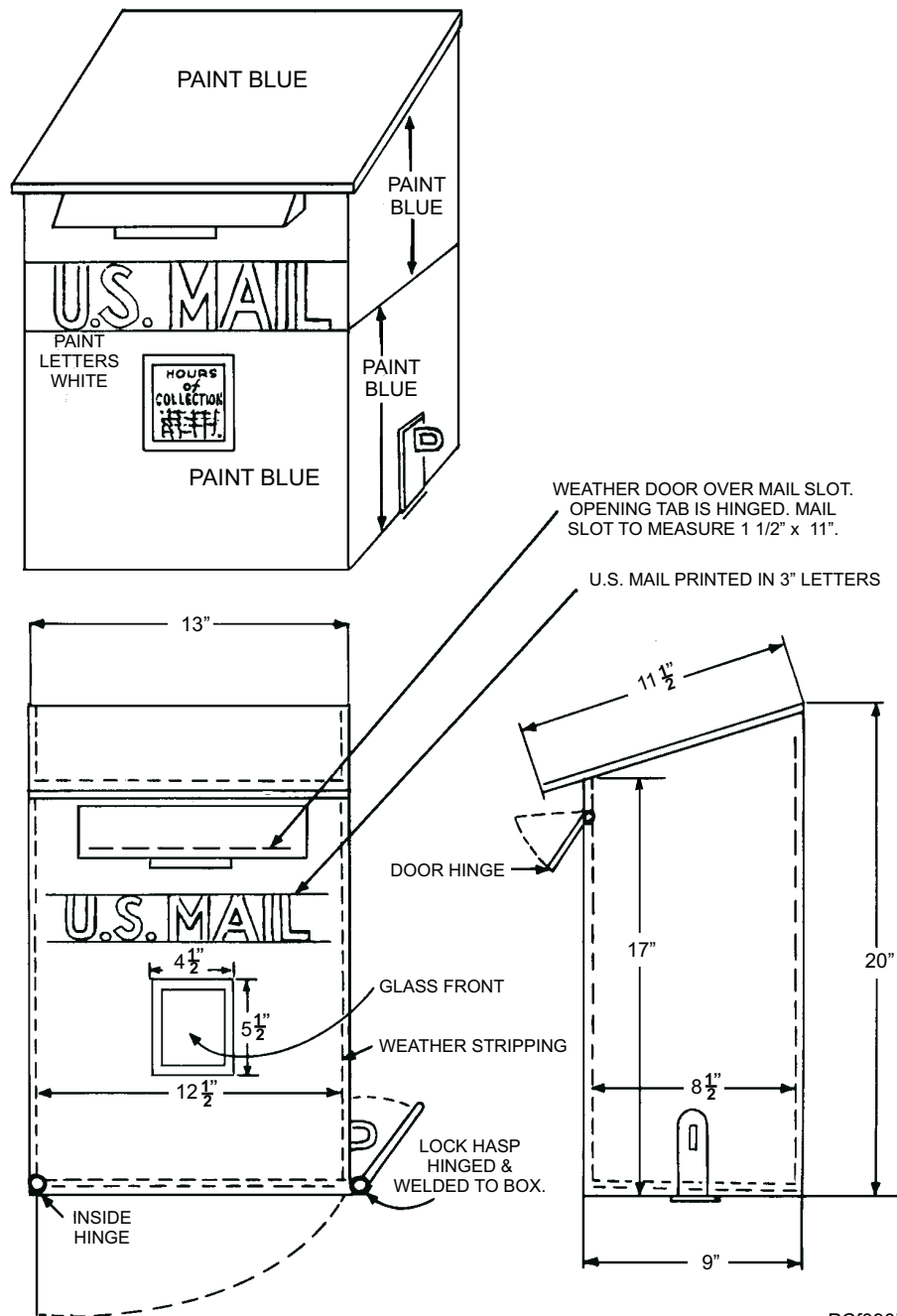

Figure 9-7.—An example of a collection box construction plan.

PCf0907

### COLLECTION SCHEDULES

A schedule for mail collections should be displayed on all collection boxes using USPS Item D1175B, Hours of Collection card (see figure 9-8). D1175B cards can be ordered through the USPS Material Distribution Center (MDC) Topeka, KS. If card D1175B is not readily available, you can show collection times on a plain 3 by 5 card until your forms arrive on board.

You should also provide information concerning the location of a collection box with a later collection

time. Specify any weekend or holiday exceptions to the regular processing and dispatch schedules. Overseas activities and deployed ships should schedule a pickup from collection boxes 7 days a week if transportation for onward dispatch is available.

Q9-18. *What step is completed first in the mail delivery cycle?*

Q9-19. *At what locations aboard ship should mail collection boxes be installed?*



HOURS OF COLLECTION					
MONDAY THRU FRIDAY EXCEPT HOLIDAY		SATURDAY		SUNDAY	
A.M.	P.M.	A.M.	P.M.	A.M.	P.M.
				HOLIDAY	
				A.M.	P.M.
BOX LOCATION FOR LATER COLLECTION					
A FINE OF \$1,000 OR THREE YEARS IMPRISONMENT FOR TAMPERING WITH THIS BOX, LOCK OR CONTENTS					
LOCATION OF THIS BOX					

PCf0908

**Figure 9-8—An example of a D1175B, Hours of Collection card.**

- Q9-20. At what locations should letter collection boxes be placed at overseas naval facilities?*
- Q9-21. Collection boxes aboard ship should be constructed of what type of material?*
- Q9-22. What type of locking device is required for shipboard collection boxes?*
- Q9-23. What unique feature does GSA three position-tumbler, series-type locks have that other locks do not?*
- Q9-24. What form is used to display the collection hours on collection boxes?*

Now turn to appendix 1 to check your answers.

### POSTAGE PAYMENT

**Learning Objective:** *Recognize the different ways mail can be sent without prepayment of postage and the manner in which these types of mail are processed.*

Postage on all mail must be fully prepaid at the time it is deposited in the post office or a collection box, except for the following types of mail:

- Business Reply Mail
- Official Mail (refer to module E of the DMM)
- Mail sent by members of the Armed Forces as Free

- Certain matter by or for the blind or handicapped
- Keys and identification cards being returned to owners

## **MAIL WITH INSUFFICIENT POSTAGE**

If domestic mail is deposited at your post office or in collection boxes with some postage attached, but not enough to fully cover the required amount, take the following steps:

- Endorse the article with the rubber stamp POSTAGE DUE \_\_\_\_\_ and enter the amount due.
- Process the article for dispatch with other mail.

Once the article reaches the office of delivery, it will be delivered to the addressee upon payment of the postage due.

If an article is addressed to a foreign country and the article does not have enough postage or any postage attached, take the following steps:

- Return the article to the mailer endorsed with the rubber-stamp RETURNED FOR \_\_\_\_\_ ADDITIONAL POSTAGE. WHEN REMAILING, CROSS OUT THIS NOTICE OR PASTE STAMPS OVER IT.
- Endorse letters, letter packages, and postcards POSTAGE DUE \_\_\_\_ Cents, if they do not bear a return address, but do not indicate the amount due. Then forward the article(s) to the international exchange office. Handle all other categories of unpaid or shortpaid mail in accordance with section 420 of the IMM.

If the mailer has indicated on a domestic article that a special service is desired and the special service fee is not included in the postage, the article will also be endorsed for the amount of the postage due for the fee, with the exception of registered mail and Express Mail. The article must also be endorsed with the service indicated, to ensure the piece of mail is given the service desired by the mailer.

- If shortpaid registered mail is found in ordinary mail, with only the First-Class rate of postage paid, the piece is delivered to the addressee as ordinary First-Class Mail. If the amount of postage and fees affixed indicate that the piece was intended to be registered, the piece is rated postage due and forwarded to the addressee as registered mail.

- For an Express Mail article that does not bear enough postage, the mailer must be contacted to correct the deficiency before dispatch. Express Mail articles without sufficient postage will never be endorsed, "Postage Due," and collection of deficient postage is never attempted from the addressee.

On shortpaid international registered articles found with ordinary mail, return the article to the sender after indicating that it is shortpaid and must be presented for registration at the post office. If the shortpaid registered article does not bear a return address, cross out the sender's registry endorsement and dispatch as ordinary mail.

## **MAIL WITHOUT POSTAGE**

Mail found in collection boxes without any postage affixed should be returned to the mailer. This mail will be endorsed with the stamp RETURNED FOR POSTAGE. If the article does not have a return address, or the delivery and return address are the same, treat the article as dead mail and forward to the serving Mail Recovery Center.

## **UNAUTHORIZED MAILERS**

If mail is found in one of your collection boxes bearing a return address of a person, firm, or activity not authorized MPO privileges, regardless of whether or not the article has postage fully prepaid, you should:

- Endorse the article SENDER NOT AUTHORIZED MPO PRIVILEGES.
- Return the article to the mailer.

## **BUSINESS REPLY MAIL**

Business reply mail enables firms and businesses to receive mail back from individuals without prepayment of postage. The firm or business provides specially printed preaddressed envelopes or cards to individuals from whom a reply is desired. Business reply permits are obtained from the USPS. MPOs are not authorized to issue business reply permits. You will most likely find business reply letters in your collection boxes. This type of mail is identified by the following endorsements:

- NO POSTAGE NECESSARY IF MAILED IN THE UNITED STATES, preprinted in the upper-right corner of the face of the envelope.

- **BUSINESS REPLY MAIL**, appearing above the address.
- **FIRST-CLASS MAIL, PERMIT NO.**, followed by the permit number and the name of the issuing post office (city and state) appearing below the Business Reply Mail legend.
- **POSTAGE WILL BE PAID BY ADDRESSEE**, appearing above the address.

This type of domestic mail is accepted at MPOs without prepayment of postage. Business reply mail having international addresses is available only to certain countries participating in this service. Refer to section 393 of the IMM for participating countries and other requirements.

### **FREE MAIL**

Under certain conditions members of the U.S. Armed Forces may send mail free. The free mailing privilege applies when the members are serving in combat areas specifically designated. When in force, the free mailing privilege applies equally to persons no longer in a combat area but, due to a wound, disease, or other injury incident to service in the designated combat area, are hospitalized in any armed forces or Veterans' Administration medical center.

### **Types of Mail That May Be Sent Free**

Letter mail, postcards, and recorded communications (sound or video) having the character of personal correspondence may be sent free. When this type of mail is sent, the mailer must write or print the word **FREE** in the upper-right corner where the postage would normally be placed. This mail must bear a complete return address.

### **Mobile Units That Do Not Have Post Offices**

Ships and other mobile units that do not have post offices may also dispatch free mail, which originated in a designated combat area:

- All mail must be endorsed **FREE**.
- The mail must be bundled separately from mail with postage stamps.
- Each bundle of mail must bear a facing slip endorsed **CERTIFIED TO BE FREE MAIL ORIGINATING IN A COMBAT ZONE**. The mail clerk or mail orderly must sign the facing slip.

### **INTERNATIONAL MAIL SENT FREE**

Some items of foreign origin do not bear postage stamps, but instead are marked **POSTAGE PAID, ON POSTAL SERVICE, SERVICE DES POSTES, TAXE PERCUE** or **TP**, or **PORT PAYEE** or **PP** followed by postmark. The marking **ON HER MAJESTY'S SERVICE** or **H.M.S.** is also sometimes used. Treat this mail as prepaid.

### **OFFICIAL MAIL**

Official mail must not be deposited in mail collection boxes. Mail clerks or mail orderlies from the office responsible for applying postage to official mail should be instructed to bring official mail to the post office. Official mail found in mail collection boxes should be turned over to the command official mail manager or the office that controls official mail.

### **INTRATHEATER DELIVERY SERVICE**

The Intratheater Delivery Service (IDS) system permits all eligible patrons of the MPS to send articles to other MPOs located within the same geographical area at no cost to the mailer. The USPS has indicated that, by definition, IDS material is not to be regarded as **MAIL**, it is **PERSONAL CORRESPONDENCE**. Therefore, any references to **FREE MAIL** are inappropriate. The difference is based on a fine distinction, but this distinction must be maintained to protect the status of the program. You must inform your postal patrons that IDS items sent free of postage must originate at a FPO or an APO. IDS articles should be processed and dispatched along with military working and foreign mail.

With respect to forwarding service, IDS items without postage must not be forwarded if addressed to individuals who have been reassigned to the United States or outside of an overseas geographical area (for example, from Atlantic to Pacific). Such items must be returned to the sender. However, items that qualify for the forwarding service will be forwarded to individuals who have changed addresses within the same geographical area.

Undeliverable items must be returned to the sender if a return address is available. Items without postage that cannot be delivered or returned to sender should be sent to the designated military dead letter office within 48 hours of receipt. This does not apply to personnel on leave, TAD, or known prospective gains; their mail should be held until they return or report onboard.

Items of value, including cash, must be turned over to a service welfare or charitable organization. Dead letter items without postage must not be forwarded to the USPS. All privileges, requirements, and priorities applicable to items in the MPS apply to IDS. This includes protection and security against theft and depredation, adherence to service standards, protection from unauthorized search and seizure procedures, and compliance with customs requirements. However, no claims will be honored by the USPS or MPS for the loss, miscarriage, or negligent transmission of personal correspondence sent without postage.

- Q9-25. List three types of mail that do not require prepaid payment of postage on articles deposited in collection boxes?*
- Q9-26. Your post office receives a domestic outgoing letter that has insufficient postage. What action should you take?*
- Q9-27. With the situation in review question 9-26 still in mind, the mailer has indicated on a letter that a special service is desired. What action should you take?*
- Q9-28. Your military post office is not authorized to issue business reply permits. (True/False)*
- Q9-29. Official mail will not be deposited in collection boxes but will be brought to the post office by an authorized mail orderly or mail clerk. (True/False)*

Now turn to appendix 1 to check your answers.

### PREPARATION OF MAIL FOR DISPATCH

---

**Learning Objective:** *Recall the steps for preparing mail for dispatch.*

---

Before you can process mail for dispatch, you will need certain mail-handling equipment. As a minimum, you should have the following equipment on hand:

- Scales
- Rubber stamps for endorsements
- Rubber bands
- Canceling machine or a flagstamp hand cancellation device
- Distribution case(s)

- Nonstandard facing slips
- Pouches and letter trays
- Large labels
- Strip labels

### COLLECTION OF MAIL

The first step in processing outgoing mail is the collection of raw (uncanceled) mail. Collection of mail from mailboxes must be made in accordance with the collection schedules you have posted on the boxes. Collection times must be set up to meet dispatch and transportation schedules to prevent delay of mail. To be comparable with USPS dispatch standards, MPOs overseas and aboard deployed units should schedule pickups from collection boxes 7 days a week if transportation for onward dispatch is available. Aboard ship, collection of mail should be made often, so when unscheduled transportation becomes available your mail is ready to go.

### FACING THE MAIL

The next step, if the amount of mail warrants, or if you have a canceling machine, is to separate the long and short envelopes. After this has been completed, face the letters by placing each with the address side up and the stamps pointing to the right. While you are facing the mail, check each piece for proper postage, correct address, and endorsements. Your office should have a scale to rate single piece mail at the dumping table along with the required rubber hand stamps used for marking short-paid mail.

Sometimes a mailer in a hurry will not include some portion of the address that is required before the article can be delivered. Return these kind of articles to the mailer promptly so as not to delay them longer than necessary.

### POSTMARKING AND CANCELING MAIL

---

**Learning Objective:** *Recall the procedures and equipment used in postmarking and canceling mail.*

---

After all the letters have been faced, it is time to postmark and cancel the stamps. Before postmarking mail, check the hand canceller or postmarking die to ensure the current date is inserted. All mail must be postmarked with the date of mailing.

The backdating of the postmark on mail is expressly forbidden, except when a specific written authorization is granted to provide philatelic treatment on a new stamp issue beyond the issuance date. Such authority is extended only when public demand for a specific first-day issue exceeds daily cancellation capabilities. Never backdate mail even for a friend.

### POSTMARKING EQUIPMENT

The USPS furnishes all canceling machine dies, hand postmarking and canceling equipment. Canceling machine dies and postmarking stamps must contain the legend U.S. Navy and the FPO number or name of the ship and hull number as applicable as well as the month, day, and year. Only USPS-supplied black ink is to be used for canceling and postmarking purposes.

### APPLYING THE POSTMARK

If you are on a large ship or at a shore activity, you may have a canceling machine (see figure 9-9). However, most ships and small commands use the hand canceller because the volume of outgoing mail does not warrant the use of a canceling machine. Do not postmark over the stamp(s). If more than one stamp has been used, cancel the stamp farthest to the left and those to the right of it with the tips of the canceling bars. Cancel the last stamp to the left with the postmark and canceling bars, and ensure that the postmark does not hit the stamp (see figure 9-10). When postmarking and canceling mail:

- The date of mailing (month, day, and year) must be included in all postmarking devices.

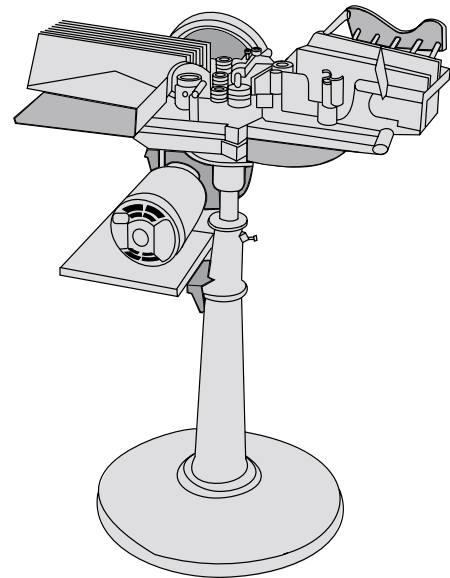

PCf0909

Figure 9-9.—An example of a canceling machine.

- The a.m. or p.m. indicator must not be used in any postmarking device.

### PHILATELIC CANCELLATIONS

Occasionally you will receive a request from collectors to apply a postmark on certain stamped cards and envelopes. It is in the best interest of the Navy to provide this service to philatelists because of the public relations value. A philatelist is a person who collects and/or studies postage stamps. Philatelic service must be carried out within the resources of your post office and should not be provided if it interferes with regular business. The USPS will release

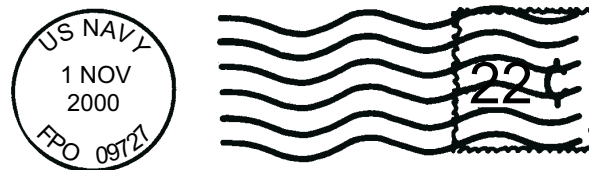

POSTMARKED AND CANCELED BY CANCELING MACHINE.

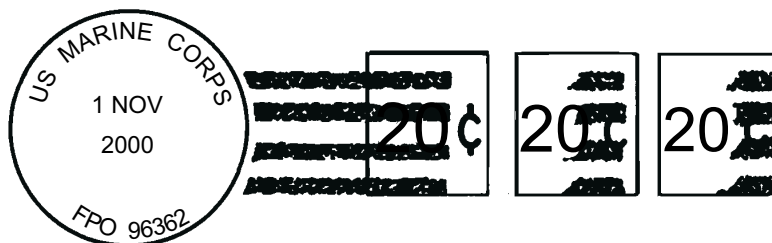

PCf0910

Figure 9-10.—Examples of canceled stamps by canceling machine and hand device.

information concerning new stamps and special events well in advance to provide philatelists sufficient time to submit covers (a cover is an envelope on which all the postal markings or cancellations have been applied). When such requests are received, you must:

- Ensure that the canceling machine or hand stamp is cleaned and serviced before postmarking the covers.
- Furnish a clear and legible postmark.
- Avoid canceling stamps by pen or illegible smudging.
- Postmark all stamps with black ink.
- Limit postmarking to five covers from each collector.
- Ensure that philatelic covers are not over canceled, backstamped, or otherwise defaced on the front or back.
- Avoid using a philatelic cover as a top piece in a bundle for destination-package labeling purposes.
- Avoid bending, folding, mutilating, or damaging the cover by rubber bands.

### **Applying Cachets**

Occasionally you may be provided a rubber stamp cachet to apply to philatelic covers when a special event occurs. A cachet is a design or inscription applied to a cover to commemorate a postal or special event. Also, most ships have their own unique cachet. When a cachet is provided, place the imprint in the lower-left corner of the envelope or card so that none of the address is covered.

To protect the interest of philatelists and the authenticity of their collections, the cachet stamp for the special event should be destroyed immediately after all eligible covers have been processed. In any case, the cachet stamp must be destroyed no later than midnight of the day of the event being commemorated.

### **Returning Covers**

Covers must be returned to the mailer, without a postmark or cachet applied, with a letter of explanation if:

- More than five covers are received from any one collector.

- The covers were received after the established deadline for providing postmarks.
- The covers bear insufficient or foreign postage. If international reply coupons (IRCs) are included, process according to the IMM.

### **MAIL SORTING**

The USPS at CONUS gateways process all military letter mail through delivery bar code sorters (DBCSs) and flat mail through flat sorting machines (FSMs). Therefore, CONUS-destined letters need only be faced, canceled, and placed in mail trays or secured with rubber bands, and placed in orange Priority Mail No.1 pouches. Pouches are to be labeled according to local FMC instructions. These pouches should be dispatched to the serving USPS facility or to the nearest FMC or MPO for further transfer. Ships should dispatch mail directly to the appropriate gateway only when they are operating in an area not served by an FMC or an aerial mail terminal (AMT).

### **BUNDLING MAIL**

After letters and flats have been cased (sorted), you are then ready to bundle the mail for dispatch (or place into mail trays, which will be discussed later in this chapter).

To ensure letters and flats remain intact and do not lose their identity during transportation, they must be properly secured before being placed in mail pouches (see figure 9-11). Bundles should be made as large as one hand can conveniently hold, approximately 4 inches thick.

Secure all letter bundles with 1/4-inch rubber bands (PS Item 0385E). Bundles up to 1 inch in thickness should be secured with one rubber band around the girth. Bundles between 1 and 4 inches in thickness must be secured with two rubber bands, the first secured around the length and the second secured around the girth. On the top of each bundle, place a nonstandard facing slip to identify the contents.

### **International Letters**

Make up international mail in direct bundles for cities or countries when volume warrants. When volume is insufficient to warrant direct bundles, make a mixed foreign bundle. Identify these bundles by a nonstandard facing slip (see figure 9-12). Send this mail to the serving FMC for further dispatch.

# BUNDLING LETTER MAIL

## I – BUNDLES FROM 1” TO 4” THICKNESS

ALL BUNDLES OF LETTER SIZE MAIL FROM 1” TO 4” IN THICKNESS SHALL HAVE RUBBER BANDS APPLIED IN THE FOLLOWING MANNER:



### STEP 1

PICK UP BUNDLE. APPLY --- FACING SLIP OR LABEL AS REQUIRED.

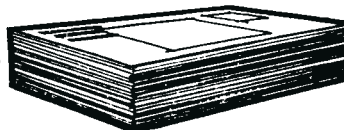

### STEP 2

PICK UP RUBBER BAND ---- PLACE OVER LONG DIMENSION OF BUNDLE.



### STEP 3

NOW PLACE ANOTHER RUBBER BAND OVER SHORT DIMENSION OF BUNDLE AT THE CENTER.

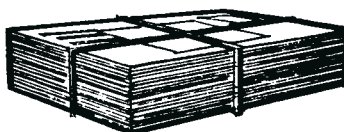

## II-BUNDLES LESS THAN 1” IN THICKNESS

THOSE BUNDLES OF LETTER SIZE MAIL LESS THAN 1” IN THICKNESS WILL REQUIRE ONE RUBBER BAND AROUND THE CENTER.



### STEP 1

PICK UP BUNDLE -- APPLY FACING SLIP OR LABEL AS REQUIRED.

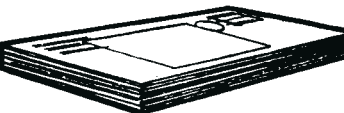

### STEP 2

PICK UP THE RUBBER BAND -- PLACE OVER SHORT DIMENSION OF BUNDLE AT THE CENTER.

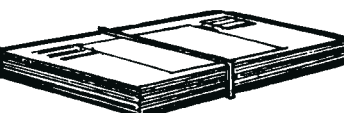

PCf0911

Figure 9-11.—Bundling letter mail.

### Military Working Mail

Mail addressed to an FPO or APO address should be bundled separately from other mail. Bundles for FPOs and APOs and other mail not to be returned to CONUS (for example, Guam and Hawaii when in WestPac) should be identified by a nonstandard facing slip labeled Military Working (see figure 9-13), placed on top of the bundle of letters. Send this mail to the serving FMC for further dispatch.

### MANAGED MAIL (MM) LETTER TRAYS

Managed Mail (MM) trays are used as a means to dispatch large volumes of letter mail. MM trays should be used by your command if volume of letter mail warrants. If not, then use Priority Mail No.1 pouches as your dispatching equipment.

Full-sized MM trays hold an average of 600 letters (average full tray weight is 8 kilos, 17.5 pounds),



PCf0912

Figure 9-12.—A bundle of mixed foreign letters.

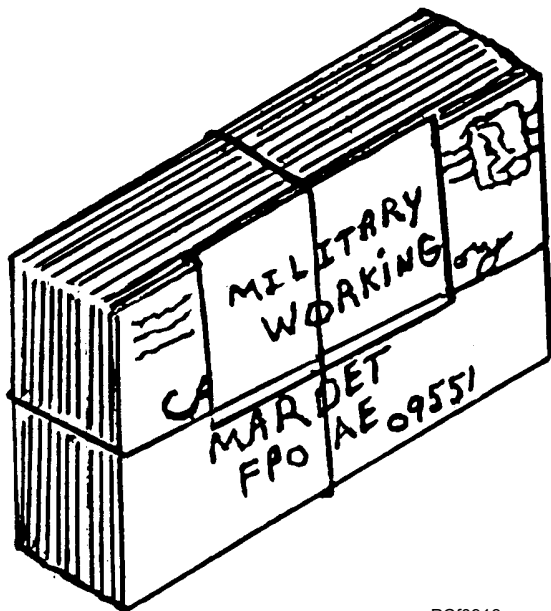

PCf0913

Figure 9-13.—A bundle of mixed military working letters.

half-sized MM trays hold an average of 200 letters. MM trays should always be filled to maximum capacity, when possible, but no less than three-fourths or 75 percent. When full-sized MM trays are less than 75 percent filled, place the mail in half-sized MM trays.

If the volume of letter mail does not warrant using MM trays, prepare letter mail in bundles as discussed earlier and place in Priority Mail No.1 pouches labeled to the serving USPS CONUS gateway or FMC as your area mail coordinator so designates.

After the tray is filled, it should be inserted into a sleeve and secured by a strap. The adhesive-backed label holder should be attached to the top-left corner of the tray. Most large shipboard commands use MM trays.

When using MM trays, treat the cardboard tray like any other piece of USPS equipment. Mail trays cost money and are intended to be used 20 times each; however, when a tray appears weak you may discard it.

## FLAT MAIL TRAYS

The USPS also uses large trays to dispatch flats. Flat trays containing First-Class Mail are identified by the green side of the cover faced outward. Overseas Navy post offices and larger ships, such as aircraft carriers, should use flat trays if volume of First-Class flats warrant.

- Q9-30. What is meant by the term facing the mail?
- Q9-31. Which types of mail must be postmarked and canceled?
- Q9-32. What agency provides all canceling machine dies and hand postmarking equipment?
- Q9-33. When canceling and postmarking stamped cards and envelopes for a philatelist, you are limited to what number of covers per collector?
- Q9-34. Letter bundles should be made no larger than how many inches in thickness?
- Q9-35. What amount of letters will normally fill a full-sized MM letter tray?

Now turn to appendix 1 to check your answers.

## POUCHING

---

**Learning Objective:** Recall the procedures for proper pouching of outgoing mail.

---

Pouches are containers made of sewn nylon, cotton, or polyester fabric with an opening at one end. Pouches have a leatherneck strap with a closing latch and eye attached near the opening.

Sacks are containers made of sewn fabric, usually nylon, polyester, canvas, or plastic, with an opening on one end. A cord or drawstring is threaded through the metal grommets or opening in the fabric.

With the exception of surface mail received in canvas sacks or in brown No.3 sacks, the majority of



mail received at military post offices is contained in pouches. When dispatching mail, MPOs normally only use pouches, so for purposes of this section, all references are to dispatching mail in pouches.

All mail will be pouched if not trayed, by classification and service, considering priorities and transportation policies. MPOs dispatching mail will follow the guidelines established by USPS in the DMM, POM, USPS HDBK T-7, and USPS PUB 52 regarding proper pouching of mail. Additionally, all MPOs will use the following general guidelines when pouching mail:

- Dispatching agencies must not commingle priority, First-Class Mail, and free mail with other classes of mail without prior approval of the serving JMPA.
- Items that could damage mailbags or other mail must not be pouched but must be dispatched as outside pieces (OSPs); sometimes referred to as outside mail (OSMs). OSPs are parcels that because of size, shape, density, weight, container, or contents cannot be placed in mail pouches.

## **FILM MAILERS**

The following procedures apply to film mailers:

- Film mailers being sent to commercial processing laboratories should be dispatched in Priority Mail No.1 or No. 2 pouches.
- Film mailers being sent to commercial processing laboratories may be consolidated with First-Class letter mail in the event the volume does not justify direct pouching.
- Film mailers not being sent to commercial processing laboratories and voice or videotape cassettes entering the customs territory of the United States (CTUS) will be pouched separately, in Priority Mail No.1 or No. 2 pouches.

## **HAZARDOUS MATERIAL**

Hazardous materials may be mailed when they meet criteria established by USPS. Special wrapping and packaging rules apply and hazardous material must be prepared for mailing, and marked, or tagged according to the instructions contained in Modules C and E of the DMM, and USPS PUB 52. If all conditions of the DMM and PUB 52 are met,

hazardous material accepted for mailing will be pouched separately from all other mail.

## **MAIL FOR MILITARY AND FOREIGN ADDRESSES**

Mail addressed to an FPO or APO address must be bundled separately from other mail and labeled **MILITARY WORKING**. These packages and other mail similarly addressed should be placed in pouches, endorsed **MILITARY WORKING**, and dispatched to the nearest FMC or MPO.

Mail addressed for delivery through international mail channels must be bundled separately from other mail, labeled **MIXED FOREIGN**, and dispatched to the nearest FMC or MPO. FMCs or MPOs receiving foreign mail must rework and dispatch such mail to the nearest civil or military post office authorized to exchange international mail.

Pouches and bundles of military working mail received at FMCs or MPOs must be reworked and dispatched according to instructions of the appropriate area mail coordinator through channels that will ensure expeditious delivery.

## **PARCELS**

Parcels accepted over the counter at finance windows or received from other sources are taken to the dispatch section and processed. Depending on the size, parcels are either enclosed in pouches or processed as outside pieces. Dispatch clerks must pouch parcels whenever possible to reduce the handling of mail.

## **OUTSIDE PIECES/MAIL (OSP/OSM)**

Parcels that require handling outside of mailbags are those that because of their size, weight, nature, or contents cannot be enclosed inside sacks without damaging them or other mail. The fact that a parcel is priority mail, sent as special handling, or contains perishable items does not in, and of itself justify outside dispatch.

A parcel is considered as an OSP/OSM if it exceeds any of the following factors:

- Size—Elongated parcels over 34 inches in length or over 17 inches in width
- Weight—Parcels weighing over 35 pounds

- Heavy Density—Small parcels of very heavy density, such as metal tools, castings, machine parts, weighing over 15 pounds, which are likely to cause damage to other sacked parcels

Also, metal containers of all shapes and sizes should be dispatched as OSPs/OSMs.

## **DISPATCHING OUTSIDE PIECES/MAIL**

When your ship is in a foreign port of call where commercial U.S. air carrier service is not available, you should use available military aircraft to dispatch OSPs/OSMs. If your only means of dispatching mail is by foreign air carrier, then you should retain on board all OSPs/OSMs until the opportunity becomes available to dispatch them to an FMC or other MPO, unless directed otherwise by the Area Mail Control Activity. You must remember that only closed mail may be dispatched through foreign postal channels or by foreign air carriers. Closed mail is mail enclosed inside a U.S. mail pouch, secured with an antipilferage seal, USPS Item 0818A.

## **CARE IN POUCHING**

Pouching requires care, not only in distribution and routing, but also in handling.

When operating overseas you will be handling large volumes of mail. Some of the mail will be parcels. Since you will be the initial carrier of the parcels you accept at your post office, make sure you do not pack more parcels in a pouch than is convenient to carry. The USPS has a set of specific rules on care in pouching, not only to protect the mail but also to protect the personnel handling the mail.

- Large orange, gray, and red pouches are limited to 70 pounds. Pouches containing letter mail must not exceed 50 pounds.
- If you do have to use canvas sacks to dispatch mail, do not place more than 70 pounds of mail in them.
- You should allow sufficient space to permit complete closure of the pouch or sack.

When individuals mailing a package request insurance, they are, in reality, asking for additional protection from breakage or loss. It is your duty to see that packages receive the protection they rightly deserve.

Do not force bulky parcels marked FRAGILE into pouches. By placing a large parcel endorsed

FRAGILE in a pouch, you eliminate any possible extra care that could be given. Large bulky parcels should be treated as OSPs and handled accordingly. Small packages carrying the endorsement FRAGILE should be placed on top of heavier parcels in the pouch to prevent them from being crushed.

## **LABELING POUCHES**

After all mail has been properly placed in pouches, the next step of dispatch is to label them. Since slide labels identify the end destination for mail contained in the pouch, extreme care must be taken to correctly label all mail before dispatch.

You should have preprinted labels on hand for the destinations to which you dispatch mail. All labels used by MPO dispatching activities should be white in color. There are two sizes of labels—large labels, for pouches with large label holders, and small labels (strip) for pouches with small label holders and canvas sacks. These labels are often referred to as slide labels. Slide labels must be ordered using PS Form 1578-B (Requisition for Facing Slips or Labels) following guidance in USPS HBK PO-423 (Requisitioning Labels). Refer to chapter 12 of this NRTC on ordering of postal supplies.

Navy post offices should always maintain a requisite amount of preprinted labels on hand. If, for some unexpected reason the stock of labels are depleted, clerks must prepare their own. To prepare labels refer to Module L of the DMM. The first line of the label should indicate the destination, the second line identifies the contents of the pouch and the weight in kilograms (see figure 9-14 for converting pounds to kilograms). The third line must identify the office of origin which is the military post office preparing the pouch for dispatch. The slide label should be dated on the reverse side with the APDS and initialed by the clerk closing the pouch.

See Table 9-1 for examples of slide labels used by overseas postal activities in Europe to dispatch the different classes and types of mail to CONUS gateways. The gateways that overseas MPOs dispatch mail to vary from location to location; with most Navy ships on deployment dispatching all their outgoing mail to either San Francisco or New York depending on their area of operation.

Dispatch sections using preprinted labels only have to annotate the weight on the front of the label and date stamp the back with the APDS and initial. On the job, you must use the correct preprinted label

## WEIGHT CONVERSION CHART

Pounds/Kilograms				Pounds/Kilograms			
Pounds/ lb	Kilograms/ Kilos	Pounds/ lb	Kilograms/ Kilos	Kilograms/ Kilos	Pounds/ lb	Kilograms/ Kilos	Pounds/ lb
1	.5	200	90.7	1	2	200	440
2	.9	300	136.1	2	4	300	660
3	1.4	400	181.4	3	7	400	880
4	1.8	500	226.8	4	9	500	1,100
5	2.3	600	272.2	5	11	600	1,320
6	2.7	700	317.5	6	13	700	1,540
7	3.2	800	362.9	7	15	800	1,760
8	3.6	900	408.2	8	18	900	1,980
9	4.1	1,000	453.6	9	20	1,000	2,200
10	4.5	2,000	907.2	10	22	2,000	4,400
20	9.1	3,000	1,360.8	20	44	3,000	6,600
30	13.6	4,000	1,814.4	30	66	4,000	8,800
40	18.1	5,000	2,268.0	40	88	5,000	11,000
50	22.7	6,000	2,721.6	50	110	6,000	13,200
60	27.2	7,000	3,175.2	60	132	7,000	15,400
70	31.8	8,000	3,628.8	70	154	8,000	17,600
80	36.3	9,000	4,082.4	80	176	9,000	19,800
90	40.8	10,000	4,536.0	90	198	10,000	22,000
100	45.4	25,000	11,340.0	100	220	25,000	55,115

PCf0914

**Figure 9-14.—A kilograms and pounds conversion chart.**

indicating the destination, type of mail, weight, and office of dispatch.

It is possible for the area mail coordinator (FMC or MPO), or in some cases the aircraft carrier your ship may be in company with, to provide instructions for you to send outgoing mail via pouch directly to them for consolidation and onward dispatch. Inform your postal officer of dispatches to avoid any confusion and delays.

### **AIRPORT-CODED TAGS (FLIGHT TAGS) AND SELF-ADHESIVE LABELS**

Slide labels, flight tags, and self-adhesive labels are the only external identifiers of end destinations for mail. Therefore, extreme care must be taken to use the correct slide labels in pouches and MM trays, correct flight tags on pouches, and the correct self-adhesive labels on MM trays and OSPs before manifesting mail.

The instructions for the proper method of completing tags and labels may be found in USPS HDBK T-7. From the time mail is dispatched to its arrival at the airport of final destination, tags provide information to the air carrier on routing for mail

pouches. Self-adhesive labels serve the same purpose for MM trays and OSPs.

Once mail is pouched and properly labeled identifying the destination, contents, weight, and office of origin, affix the proper airport-coded tag to the pouches. For OSPs and MM trays, attach airport-coded self-adhesive labels.

You should be careful in selecting and preparing flight tags to avoid mail being misrouted by the air carrier. For example, a pouch containing First-Class Mail destined for mixed states tendered to a commercial air carrier from a ship operating in the Pacific Ocean should have a label inserted in the label holder reading AMC SAN FRANCISCO CA 940. The final airport destination for this pouch should be San Francisco. Therefore, the flight tag must read SFO (San Francisco). Place the tag over the pouch staple and beneath the hasp before sealing the pouch. The pouch grommet is not used for attachments of any tags.

When preprinted airport-coded flight tags and self-adhesive labels are not available, prepare the appropriate tags and labels by printing the three-letter city of destination code in the appropriate portion of PS Tag 135-B and PS Label 136-B (see figure 9-15). For

Table 9-1—Examples of preprinted slide labels.







<h1 style="text-align: center;">PRIORITY POUCHES &amp; OUTSIDE PIECES</h1> <p style="text-align: center;">(WILL NOT EXCEED 70 LBS IN WEIGHT)</p> <p style="text-align: center;">EQUIPMENT: ORANGE PRIORITY MAIL POUCHES, PS TAG 135 (APRIL 98), ACT TAG HOLDER O625, ACT TAG FILE CABLE 0625A FOR POUCHES. PS LABEL 136 FOR OUTSIDE PIECES.</p> <p style="text-align: center;">SORTING, LABELING, AND TAGGING CHART</p>		
ZIP	SLIDE LABEL	CODE TAG
<b>0-1</b>	AMC KENNEDY NY 00300 MIL PRIORITY  <small>1400000362</small> USS BATAAN (LHD-5)	<b>JFK</b>
<b>2</b>	IMPC DULLES VA 201 MIL PRIORITY  <small>1400000362</small> FPO AE 09609	<b>IAD</b>
<b>3</b> APO/FPO AA 34XXX	AMC MIAMI FL 331 MIL PRIORITY  <small>1400000362</small> FPO AE 09499	<b>MIA</b>
<b>4-5-6</b>	AMC O'HARE IL 606 MIL PRIORITY  <small>1400000362</small> FPO AE 09499	<b>ORD</b>
<b>7</b>	AMC DALLAS TX 75261 MIL PRIORITY  <small>1400000362</small> FPO AE 09625	<b>DFW</b>
<b>8-9</b>	AMC SAN FRANCISCO CA 962 MIL PRIORITY  <small>1400000362</small> FPO AE 09499	<b>SFO</b>

Table 9-1—Examples of preprinted slide labels Continued.

# SAM/PAL POUCHES & OUTSIDE PIECES

(WILL NOT EXCEED 70 LBS IN WEIGHT)

EQUIPMENT: RED SAM PARCEL POST POUCHES, PS TAG 135 (APRIL 98),  
ACT TAG HOLDER O625, ACT TAG FILE CABLE 0625A FOR POUCHES. PS LABEL 136 FOR OUTSIDE PIECES.

SORTING, LABELING, AND TAGGING CHART





ZIP	SLIDE LABEL	CODE TAG
PAL  <b>0-1</b>	AMC KENNEDY NY 00300 MIL PAL  <small>140000362</small> FPO AE 09626  <b>JFK</b>	<b>JFK</b>
SAM  <b>0-1</b>	FGN CENTER 099 MIL SAM  <small>140000362</small> USS SUPPLY (AOE-6)  <b>EWR</b>	<b>EWR</b>
SAM/PAL  <b>2</b>	BMC WASHINGTON DC 20499 MIL SAM  <small>140000362</small> FPO AE 09499  <b>IAD</b>	<b>IAD</b>
SAM/PAL  <b>3</b>  APO/FPO AA 34XXX	BMC JACKSONVILLE FL 32099 MIL SAM  <small>140000362</small> FPO AE 09627  <b>MIA</b>	<b>MIA</b>
SAM/PAL  <b>4-5-6</b>	BMC CHICAGO IL 60808 MIL SAM  <small>140000362</small> FPO AE 09644  <b>ORD</b>	<b>ORD</b>
SAM/PAL  <b>7</b>	AMC DALLAS TX 75261 MIL PRIORITY  <small>140000362</small> FPO AE 09623  <b>DFW</b>	<b>DFW</b>
SAM/PAL  <b>8-9</b>	BMC SAN FRAN CA 962 MIL SAM  <small>140000362</small> FPO AE 09626  <b>SFO</b>	<b>SFO</b>

Table 9-1—Examples of preprinted slide labels Continued.

**NEWSPAPERS, MAGAZINES, & NON-PRIORITY FLATS WILL BE DISPATCHED IN RED SAM NO.1 MAIL POUCHES LABELED AND TAGGED AS INDICATED BELOW. THE NEW PS TAG 135 DATED APRIL 1998, ACT TAG HOLDER 0625, ACT TAG TIE CABLE 0625A.**

ZIP	SLIDE LABEL	CODE TAG
<b>ALL ZIPS</b>	FGN CENTER 099 MIL NEWS SAM  <small>1400000362</small> FPO AE 09623 <b>EWR</b>	<b>EWR</b>

**SOUND-RECORDED COMMUNICATIONS, FILMS, AND TAPES WILL BE POUCHED IN PRIORITY ORANGE NO. NO. 1 OR NO. 2 POUCHES AND LABELED AND TAGGED AS SHOWN BELOW.**

ZIP	SLIDE LABEL	CODE TAG
<b>ALL ZIPS</b>	AMC KENNEDY NY 00300 MIL PRI FILMS & TAPES  <small>1400000362</small> USS JOHN F KENNEDY (CV 67) <b>JFK</b>	<b>JFK</b>

PCf0901c

Table 9-1—Examples of preprinted slide labels Continued.

## LETTER TRAYS

ALL LETTER MAIL DESTINED FOR CONUS GATEWAYS WILL BE TRAYED TO JFK

EQUIPMENT: PS ITEM 3916, 3916A, 3916B, 3916C

MANAGED MAIL TRAY WITH LID AND PS LABEL 136

SORTING, LABELING, AND TAGGING CHART

ZIP	SLIDE LABEL	CODE TAG
<p><b>0-1-2-3-4</b> <b>5-6-7-8-9</b></p> <p>MPOs AP 96XXX MPOs AA 34XXX</p>	<p>AMC KENNEDY NY                      00300</p> <p>MIL LTRS</p>  <p style="font-size: small; text-align: center;">1400000362</p> <p>FPO AE 09627</p> <p style="font-size: 2em; font-weight: bold; margin-left: 100px;">JFK</p>	JFK

## FLAT TRAYS

ALL FLATS DESTINED FOR CONUS GATEWAYS WILL BE TRAYED TO JFK

EQUIPMENT: PS ITEM 1257-T (PLASTIC TRAY)

WITH GREEN LID AND PS LABEL 136

SORTING, LABELING, AND TAGGING CHART

<p><b>0-1-2-3-4</b> <b>5-6-7-8-9</b></p> <p>MPOs AP 96XXX MPOs AA 34XXX</p>	<p>AMC KENNEDY NY                      00300</p> <p>MIL FLTS</p>  <p style="font-size: small; text-align: center;">1400000362</p> <p>FPO AE 09627</p> <p style="font-size: 2em; font-weight: bold; margin-left: 100px;">JFK</p>	JFK
---	--	-----

PCf09001d

Table 9-1—Examples of preprinted slide labels Continued.

<b>EXPRESS MAIL ROUTING</b>		
<b>OVERSEAS SHORE-BASED POST OFFICE ONLY</b>		
EQUIPMENT: EXPRESS MAIL POUCHES, PS TAG 135 (APRIL 98), ACT TAG HOLDER 0625, ACT TAG FILE CABLE 0625A FOR POUCHES & PS LABEL 136 FOR OUTSIDE PIECES. SORTING, LABELING, AND TAGGING CHART		
ZIP	SLIDE LABEL	CODE TAG
<b>0-1-3</b>	AMC KENNEDY NY 00300 MIL EMMS  <small>1400000362</small> FPO AE 09625 <span style="float: right;"><b>JFK</b></span>	<b>JFK</b>
<b>2</b>	IMPC DULLES VA 201 MIL EMMS  <small>1400000362</small> FPO AE 09421 <span style="float: right;"><b>IAD</b></span>	<b>IAD</b>
<b>4-5-6</b>	AMC O'HARE IL 606 MIL EMMS  <small>1400000362</small> FPO AE 09649 <span style="float: right;"><b>ORD</b></span>	<b>ORD</b>
<b>7</b>	AMC DALLAS TX 75261 MIL EMMS  <small>1400000362</small> FPO AE 09626 <span style="float: right;"><b>DFW</b></span>	<b>DFW</b>
<b>8-9</b>	AMC SAN FRANCISCO CA 962 MIL EMMS  <small>1400000362</small> FPO AE 09844 <span style="float: right;"><b>SFO</b></span>	<b>SFO</b>

PC10901e



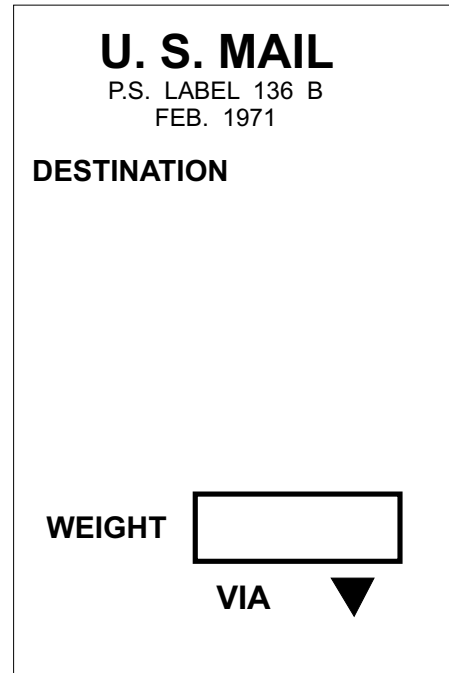
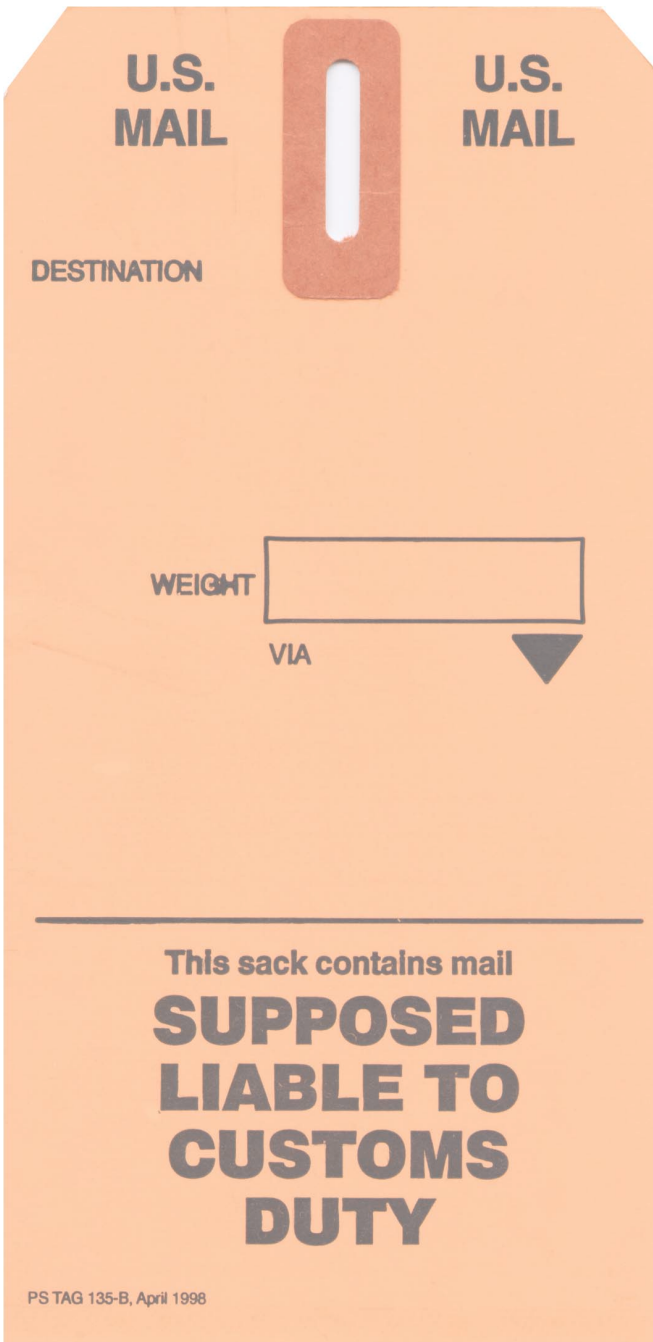

**Figure 9-15.—A flight tag and label used to identify destination of mail.**

PCf09115

information on ordering USPS tags and labels, refer to Chapter 12. Pouches, MM trays, and OSPs with an airport-coded tag or self-adhesive label attached should have the weight shown in kilograms in the weight block on the tag or label and the flight information when known.

When using self-adhesive labels to identify the proper airport of destination on OSPs, affix these labels to the left of the address so other required markings are not obliterated.

Remember; do not dispatch OSPs if a foreign airline is used unless authorized by the Area Mail Control Activity.

### **DISPATCHING MAIL AT FLEET MAIL CENTERS**

Fleet mail centers (FMCs) receive, sort, store (when necessary), consolidate, and dispatch mail received from or addressed to all post offices served. FMCs also route outgoing and incoming mail received

at the FMC addressed to or from fleet units. The FMC will handle a certain amount of raw mail for dispatch, but the greater amount of mail handled will be from mobile units for further transfer to destination in the United States.

The FMC consolidates outgoing mail by sorting, pouching, and traying the different classes of mail received from various local activities and from some small mobile units. This method reduces the number of pouches, or trays for one destination and allows for a more expeditious mail delivery system. Each FMC is responsible for pouching mail and preparing it for dispatch as far ahead in the domestic postal system as possible.

*Q9-36. Letters destined for foreign countries and military activities known to be located overseas should be bundled separately. (True/False)*

*Q9-37. Define OSP.*

*Q9-38. A letter mail pouch should be limited to what maximum weight?*

*Q9-39. What identifies the end destination when a letter pouch is closed, sealed, and ready for dispatch?*

*Q9-40. What publication should you refer to when preparing printed airport-coded tags and labels?*

*Q9-41. An OSP will have an airport-coded label rather than a tag attached when dispatched via commercial air carrier. (True/False)*

*Q9-42. The process of consolidating mail for dispatch at FMCs serves what purpose?*

Now turn to appendix 1 to check your answers.

## **TRANSPORTATION OF MILITARY MAIL**

---

**Learning Objective:** *Recall the responsibility for funding and the types of transportation available for military mail.*

---

The Military Postal Service is responsible for moving military mail responsively, economically, and efficiently in support of the defense missions of the United States. Military mail is any domestic or international mail that bears a military address or return address and at some stage in its transmission is

in the possession of the Department of Defense. Now we will discuss funding for mail transportation, the types of documentation methods, and documentation requirements.

## **FUNDING FOR MILITARY MAIL TRANSPORTATION**

USPS pays for the movement of military mail by commercial air carriers, foreign and domestic. The military departments then reimburse USPS for the movement of mail to and from the United States and within overseas areas. Additionally, the military departments pay for movement of military mail between the United States, its territories, commonwealths, and possessions when a mode of transportation is selected or a service is provided that is not available to domestic USPS customers. The Navy also pays for mail moved via AMC airlift, rail, or truck within each command's area of responsibility, unless prior arrangements have been made with MPSA.

Since FPO mail is funded separately, it should be documented separately from APO mail on dispatch documents. For definition purposes FPO mail is mail generated at Navy and Marine Corps postal activities, regardless of the end destination. It includes mail originating in the United States and dispatched to FPOs.

## **TYPES OF TRANSPORTATION METHODS**

The specific modes of transportation used for the movement of military mail are airlift, sealift, and land transportation. The transportation used depends on the location of the activity, the method of transportation available, and the lead-time required to get the mail there. NOTE: Sealift is only used to dispatch surface mail from CONUS to overseas locations. As a postal clerk, you will be directly concerned with the available modes of transportation, when to use them, how much space will be available, and the proper documentation required depending upon the method of transportation used by your office.

### **U.S. Carriers**

All eligible military mail transported to and from overseas activities will be transported by U.S. commercial air carriers as the primary means of transportation. The USPS and MPSA, along with the JMPAs located in New York and San Francisco, have already established transportation routes and coordinated with commercial airlines to provide the necessary service needed to move military mail to its intended destination(s). Parcel airlift mail (PAL) and

space-available mail (SAM) should be tendered last to an air carrier after all other categories of mail have been accepted.

Military mail tendered to U.S. commercial airlines by MPO's will be manifested on PS Form 2942-A, Military Mail AV-7 Delivery List. We will discuss this form later in the chapter.

### **Foreign Air Carriers**

When U.S. commercial air carriers or U.S. military air carriers are not available, MPO's may request the services of a foreign air carrier to transport military mail. The initial request to use a foreign commercial air carrier must be directed to MPSA, who coordinates with USPS to obtain approval. Approval to use a foreign air carrier will be limited to those routes where U.S. commercial air service or U.S. military aircraft are not available, or do not meet established delivery service standards. If the request is approved by MPSA and USPS, the affected military postal unit(s) will be notified of the approved air carrier, flight dates, and flight numbers before shipping any mail. The use of foreign airlines will be discontinued or modified when adequate U.S. commercial or military air service becomes available.

Military postal units must use PS Form 2942-A, Military Mail AV-7 Delivery List to manifest mail for transport on approved foreign commercial air carriers. When using a foreign air carrier postal clerks must:

- Pouch all mail (no outside pieces). This means that First-Class mail, in MM trays, must be placed inside large U.S. Priority Mail pouches. Other classes of mail must be placed inside an appropriately colored and labeled mail pouch, before dispatching.
- Make arrangements with the foreign airline representative to accept the mail.
- Provide the foreign airline representative with the estimated volume (pieces and kg-weight) that will be dispatched, the flight number used, the frequency of dispatch, and the end destination where the mail will be off-loaded.
- Ask the foreign airline rep to inform their representatives at the end destination to expect receipt of U.S military mail shipment(s), and that the mail should be turned over only to U.S. military postal personnel and not to the host government. This does not apply for dispatches from overseas locations to CONUS.

- Ensure that military postal personnel at the end destination (overseas locations only) are aware of shipments by foreign airline and all particulars so that MPS personnel can make arrangements to meet the flight and receive the mail as soon as possible. Never send outside mail or registered mail via a foreign air carrier unless authorized by the area mail control activity.

### **Air Mobility Command (AMC) Aircraft**

The U.S. Air Force operates military cargo and cargo/passenger aircraft and contracts to private airlines to carry passengers, cargo, and mail. Use of AMC assets is limited to areas where U.S. commercial air carriers do not provide service (such as hostile areas), or the frequency of flights or space is insufficient and cannot ensure delivery. AMC assets may also be used whenever adequate surface transportation is not available, when transit times for surface mail is considered excessive, or when Space Available Mail (SAM) cannot be moved by commercial carriers in a timely manner and an inordinate amount of delay would occur before the mail would be transported.

Military postal units will use DD Form 1384, Transportation Control and Movement Document, better known as a "TCMD," to manifest military mail for shipment by AMC aircraft.

### **Military Sealift Command**

Surface mail is transported by commercial ships as arranged by the Military Sealift Command (MSC). Sea-Van containers are used for dispatching mail sealifted between the United States and overseas areas, and between geographical locations overseas. Sea-Van containers provide security and eliminate unnecessary handling of the mail. Postal activities using Sea-Van containers for dispatching mail should properly secure the doors of the containers with a numbered tin-band seal (USPS Item 0817A), and heavy gauge wire.

### **Command-Owned Air Carriers**

Once mail is received at overseas locations, airlift transport is provided for deployed ships by the services of an air squadron based in the area of operation. Mail is transported by COD (carrier onboard delivery) to the aircraft carrier for further transfer by helo or highline

to other ships operating with the aircraft carrier as part of the battle group.

### Command Mail Vehicles

Military postal clerks will use DD Form 1372, Mail Manifest, or OPNAV Form 5110/9, Mail Manifest, when dispatching mail locally. A closed-body vehicle equipped with lockable doors must be used to transport mail between postal activities or carrier facilities on or off the installation. If the vehicle driver is not a designated postal clerk and has a key or combination to the lock used to secure the vehicle, then a tin-band seal, Item 0817A, should be affixed to the secured doors. This will maintain the integrity of the shipment. If a designated postal clerk, serving as a mail guard, is accompanying the shipment, or the vehicle driver does not have access to the key or combination to the lock, then a tin-band seal is not required. But, a tin-band seal is mandatory if registered mail is being transported. The seal number must be entered on the mail manifest by the dispatching activity.

If an open-body vehicle is used, a guard must ride in the truck body with the mail. This precaution is not required in those situations where mail is being transported on pallets or in igloos. In this case, the guard may ride in the cab of the truck, but must maintain visual contact of the mail at all times. Extreme care must be taken to make sure the vehicle doors close properly and that the doors do not open while in transit.

- Q9-43. Give the definition of military mail.
- Q9-44. What are the three specific modes of transportation used for the movement of military mail to Navy postal activities?
- Q9-45. Military mail transported between the United States and overseas military activities is normally transported via what type of air carrier?
- Q9-46. When a U.S. commercial airline is used to transport mail, how should your dispatch be tendered?
- Q9-47. What type(s) of mail must not be tendered on any foreign airline?

Now turn to appendix 1 to check your answers.

## DOCUMENTATION REQUIREMENTS FOR DISPATCHING

---

**Learning Objective:** *Determine the appropriate manifest to use to transport mail and the preparation requirements for each.*

---

This section is concerned with accounting for the mail. You should always obtain a receipt for the mail you dispatch and give one for the mail you receive. To do this, mail should be documented for shipment on PS Form 2942-A, Military Mail AV-7 Delivery List; DD Form 1372, Mail Manifest; DD Form 1384, Transportation Control and Movement Document (TCMD); or OPNAV Form 5110/9 Mail Manifest depending upon the transportation being used.

### PS FORM 2942-A (AV-7)

Use this form to dispatch mail on any domestic or foreign commercial air carrier. Prepare PS Form 2942-A (see figure 9-16) neatly and legibly, using a ballpoint pen (black ink) typewriter, or by completing a computer-generated form.

- When military mail is dispatched to and transported solely by a U.S. commercial air carrier or a single foreign-flag air carrier, prepare one PS Form 2942-A form set.
- When mail is transferred between a U.S. air carrier and a foreign-flag air carrier, or between two U.S. carriers, prepare sufficient sets of PS Form 2942-A to allow each carrier five copies.

PS Form 2942-A is a printed set of seven (7) sheets. You must provide a completed original and four (4) copies to the air carrier representative at the time of the dispatch. Keep two legible copies of each completed AV-7. One will be retained in the dispatching activity's files, the other will be sent to the Supervisor, IAMRU, Dulles IMF RM 255, 44715 Prentice DR, Dulles VA, 20101-9998, by First-Class USPS indicia mail, at the end of each day.

The form breaks down mail into three categories: AIR, MOM (Military Ordinary Mail), and SAM (Space Available Mail). In a previous lesson you learned about the different categories of mail, but we didn't cover Military Ordinary Mail. MOM consists of official mail sent by military departments, mailed at the Standard Mail or Periodicals postage rates, that require faster than sealift transportation service to and from the United States and between overseas points,

but does not require priority service. Mailings must bear the “MOM” marking in addition to the class of mail.

List Express mail, First-Class, and Priority mail as “AIR.” Place the piece count for Express and First-Class mail letters in the “LC” column. List all Express and Priority mail parcels in the “CP” column. The categories MOM and SAM are self-explanatory. DO NOT list MOM or SAM mail in the “LC” column.

Key points to remember when preparing the AV-7 are as follows:

- Manifest APO and FPO mail separately.
- All weights must be expressed in kilograms, rounded off to the nearest 1/10th of a kilo (e.g. 292.5 kgs).
- Print the information neatly and legibly. Use a ballpoint pen, typewriter, or computer.
- Make sure mail is listed under the proper mail category (Air, MOM, or SAM.)
- Total the weights in the respective weight column.

Correct errors detected after preparation in the following manner:

- line through the incorrect entry,
- add the correct entry, and
- initial the correction.

Prepare PS Form 2942-A as follows:

**Block A:** Enter the dispatch number. Begin each month with 001. Place an “X” after the number to indicate the last dispatch of the month (e.g., 024X).

**Block B:** Postmark with the APDS, and enter the geographical location of the dispatching activity. USS Underway (CV-66), Catania Sicily.

**Block C:** Enter the actual date the AV-7 is prepared to tender mail to the air carrier (i.e., 23 Jun 01).

**Block D:** Enter a “Check Mark” in the appropriate block, “APO” for Army/Air Force originated mail, “FPO” for Navy/Marine Corps/Coast Guard originated mail.

**Block E:** Enter the destination three-letter airport code and the city/state or city/country (i.e., JFK, New York, NY).

**Block F:** Enter the respective dispatching and receiving activity’s three-letter airport code, followed by a slash,

then the three-letter air carrier code and the airline’s flight number (i.e., CTA to ROM/AZ1 102, ROM to JFK/DAL 111).

**Block G:** Leave blank. Completed by the receiving activity.

**Block H:** Enter the three-letter airport code of the dispatching activity (your postal activity) for each category of mail manifested (i.e., CTA).

**Block I:** Enter the three-letter airport code of the destination airport (the location where the mail is being sent to) for each category of mail manifested (i.e., JFK).

**Block J:** Enter the total number of Express and letter mail pouches in this column (i.e., 5).

**Block K:** Enter in this column the total number of pieces, by category (i.e., AIR [to include Express mail] 5, MOM 7, and SAM 8).

**Block L:** Enter the total weight of Express and letter mail pouches in this column (i.e., 68.2). Round off weight to the nearest 1/10th kilo.

**Block M:** Enter the total weight of parcels by category (i.e., AIR [to include Express Mail] 136.4, MOM 95.5, and SAM 109.1). Round off the weight to the nearest 1/10th kilo.

**Block N:** Used to record specific or amplifying information regarding each category of mail.

**Block O:** Enter the total number of “LC” and “CP” pieces (i.e., add all “J” and “K” entries).

**Block P:** Enter the total weight of Express and letter class mail in the shipment (i.e., add all “L” entries).

**Block Q:** Enter the total weight of parcels in the shipment (i.e., add all “M” entries).

**Block R:** The air carrier representative signs here to receipt for the mail.

**Block S:** Leave blank. The receiving activity signs here to receipt for the mail from the respective air carrier representative upon arrival at the destination airport.

### **DD FORM 1372 (MAIL MANIFEST)**

Use this form to dispatch mail between facilities within the same geographical area, for example; from one MPO to another MPO, from an MPO to the AMT or FMC, from the AMT to the FMC. Normally, the mode of transport will be by truck (closed container military or contract vehicle).

DD Form 1372 (see figure 9-17) is completed in an original and two copies. The original and one copy is

DISPATCHING OFFICE <i>Bureau expéditeur</i>		United States Postal Service <b>MILITARY MAIL AV-7 DELIVERY LIST</b> <i>Bordereau de livraison des dépêches aériennes</i>				AV-7 CONTROL NO.  001 <span style="float: right;">(A)</span>	
(B)		(D) Check (✓) one <input type="checkbox"/> APO <input checked="" type="checkbox"/> FPO				RECEIVING BUREAU <i>Bureau destinataire</i>	
USS UNDERWAY (CV-66) CATANIA, SICILY		FOR AIRPORT OF <span style="float: right;"><i>Aéroport de déchargement</i></span>  (E) JFK, NEW YORK NY				(G)	
DATE OF DEPARTURE (C) 23JUNE 2001		Carrier, Flight, and Routing  (F) CTA TO ROM/AZ1 102 ROM TO JFK/DAL 111					

	Office of Origin <i>Bureau d'origine</i>	Office of Destination <i>Bureau destinataire</i>	Pieces		Gross Weight of the Mails <i>Poids bruts des sachs</i>		Remarks <i>Observations</i>
			LC Letters Cards	CP Parcel Post	Letters <i>De correspondances</i> (Grams)	Parcel Post <i>Du colis</i> (Grams)	
AIR	CTA	JFK	5 (J)	10	(L) 68.2	136.4	(N)
A							
I							
R							
MOM	(H) → CTA	(I) → JFK	(K) → 7			(M) → 95.5	
M							
O							
M							
SAM	CTA	JFK		8		109.1	
S							
A							
M							
		(O)			(P)	(Q)	
	TOTAL SACKS	30	TOTAL WEIGHT BY CLASS		68.2	341.0	TOTAL WEIGHT BY CLASSES
Signature of Air Carrier Representative accepting the mails entered hereon (R)				Signature of Post Office Official receiving the mail (S)			
				(Signature du bureau destinataire)			

PS Form 2942-A, November 1992

Figure 9-16.—A completed PS Form 2942-A.

PCf0916

sent with the mailguard. The triplicate is maintained as a suspense copy by the dispatching activity. Once the mail has been delivered and signed for, the receiving MPO keeps the original. The signed duplicate is returned with the mailguard to the office of dispatch and becomes the record file copy. The triplicate copy can then be destroyed.

Prepare DD Form 1372 neatly and legibly, using a ballpoint pen (black ink), typewriter, or computer. All weights must be expressed in kilograms to the nearest tenth of a kilo.

Do not erase errors made on this form. Make necessary corrections with one straight line through the incorrect information, initial the correction, and enter the correct information. No more than one or two corrections should be made on the form. If more corrections are required, a new form should be prepared.

Prepare DD Form 1372 as follows:

Block 1: Enter the dispatching activity's APO/FPO address.

Block 2: Leave blank.

Block 3: Enter the receiving activity's APO/FPO address.

Block 4: Leave blank.

Block 5: Enter the current date (YY/MM/DD).

Block 6: Enter the local time that the mail is dispatched.

Block 7 through 13: Enter in the respective columns the number of pieces and weight (in kilograms) for each category of mail.

NOTE: First-Class MM letter trays will be listed separately in block 12.

Block 14: Enter the total number of pieces and total weight.

Block 15: Enter an "X" in the box that describes the type of transport.

Block 16: Enter flight number, or tail/side number, if applicable.

Block 17: Enter train number, if applicable.

Block 18: Enter the side number or license plate number of the truck, if applicable.

Block 19: Enter the number of the outside (door) seal for the truck container.

Block 20: Signature and grade of the dispatcher. At an FMC the section leader normally completes this.

Block 21: Signature of the mailguard or truck driver if a mailguard is not used.

NOTE: Blocks 22 through 25 are left blank. These blocks are completed by the receiving activity.

## **DD FORM 1384 (TCMD)**

DD Form 1384 "TCMD" (see figures 9-18 and 9-19) is a multipurpose form used when transporting any item within the DOD transportation network. This form is used when manifesting mail for transport by Air Mobility Command (AMC) or Military Sealift Command (MSC) assets.

Manifest APO and FPO mail separately. List all classes and types of mail on the same form with the exception of registered mail. Prepare a separate form to manifest registered mail.

For a single shipment of ordinary mail, complete blocks 1 through 23 as applicable.

NOTE: When completing blocks of the TCMD that require a date entry, enter the Julian date, unless otherwise specified.

Prepare DD Form 1384 as follows:

Block 1: Document Identification: Always enter TG-1.

Block 2: Container number: Leave blank.

Block 3: Consignor (dispatching activity): Enter the APO/FPO number preceded by a "0", or the six letter abbreviation of the postal activity. For example, if the mail is being dispatched from the London AMT APO AE 09463, then you write either 009463 or LONAMT.

Block 4: Commodity-Special Hdlg: Enter "U-1 or MAIL."

Block 5: Air dimension: Leave blank.

Block 6: POE (Port of embarkation): Enter the three-letter airport code identifying the dispatching activity (e.g., LON).

Block 7: POD (Port of debarkation): Enter the three-letter airport code identifying the terminal servicing the receiving activity (e.g., FRA).

Block 8: Mode of Shipment: Enter the letter "F."

Block 9: Type Pack: Enter "PC."

<b>MAIL MANIFEST</b>	1. DISPATCHED FROM <b>FPO AE 09645</b>	2. CODE	3. TO: <b>APO AE 09641</b>	4. CODE	5. DATE <b>010123</b>
					6. HOUR <b>1800</b>
MAIL CATEGORY		PIECES	WEIGHT	15. VIA (Check One)	
7. REGISTERED MAIL (Do not use for transfer of accountability)		<b>15</b>	<b>204.6</b>	<input type="checkbox"/> AIR <input type="checkbox"/> RAIL	
8. AIR MAIL		<b>62</b>	<b>843.2</b>	<input checked="" type="checkbox"/> TRUCK <input type="checkbox"/> BUS	
9. MILITARY OFFICIAL MAIL		<b>13</b>	<b>174.2</b>	<input type="checkbox"/> OTHER(Specify)	
10. SPACE AVAILABLE MAIL		<b>47</b>	<b>629.8</b>	16. FLIGHT NO.	
11. SURFACE				17. TRAIN NO.	
12. <b>FIRST CLASS LTR TRAYS</b>		<b>8</b>	<b>107.2</b>	18. VEHICLE NO. <b>GSA12345</b>	
13. EMPTY EQUIPMENT				19. SEAL NO. <b>9876543210</b>	
14. TOTAL		<b>145</b>	<b>1959.0</b>		
20. SIGNATURE OF DISPATCHER (Name and grade)		21. I ASSUME RESPONSIBILITY FOR MAIL IN MY CUSTODY (Signature of Mail Guard)			
22. SIGNATURE OF RECEIVING CLERK		23. DATE AND HOUR		24. DELAYS/INCIDENTS <input type="checkbox"/> NONE <input type="checkbox"/> DELAYED	
25. REMARKS (Continue on reverse, if necessary)				____HRS. (Explain in item 25)	

DD FORM 1372 PREVIOUS EDITION WILL BE USED

PCf0917

Figure 9-17.—A completed DD Form 1372, Mail Manifest.

Block 10: Transportation Control Number (TCN): TCN's consist of a 17 position letter/number combination unique to each shipment. Example: 0094634001X002XXX or LONAMT4001X002XXX.

POSITION	DESCRIPTION
1-6	same as block 3 (009463).
7	last digit of the calendar year (94 = 4).
8-10	Julian date. (January 1st = 001).
11	enter an "X."
12-14	enter the 3-digit dispatch number (i.e., the 2nd dispatch of the day = 002).
15-17	enter "XXX."

Block 11: Consignee (receiver): Enter the 5 digit APO/FPO number of the receiving MPO preceded by a "0," or, enter a six-letter abbreviation of the receiving activity. For example, let's say that you were dispatching mail to the Frankfurt AMT APO AE 09060, then enter either 009060 or FRAAMT.

Block 12: Priority—Enter one of the following codes: "1"—First Class, Priority, and Registered, "2"—MOM, PAL, and SAM mail.

Block 13: RDD (Required Delivery Date): First-Class mail and Registered mail—use "999." For all other categories of mail, use Julian date shipped plus 2 days (i.e., 999 or 4003 [4001 + 2]).

Block 14: Project: Leave blank.

Block 15: Date shipped: Enter Julian date (e.g., 4001).

Block 16: ETA (Estimated time of arrival): Leave blank.

Block 17: TAC (Transportation Account Code): Enter one of the following codes: 0001—APO mail 0002—FPO mail.

Block 18: Carrier: Enter "AMC."

Block 19: Leave blank.

Block 20: Leave blank.

Block 21: Remarks: Ordinary mail—leave blank, registered mail—enter the words "REGISTERED MAIL."

Block 22: Pieces: Enter the total number of pieces shipped.



Block 23: Weight: Enter the total weight of all mail, “in U.S. POUNDS.”

NOTE: The remaining blocks will be left blank for a “single shipment” TCMD. For shipments of registered mail, the following additional blocks must be completed:

Blocks 33, 34, and 35: Enter the words REGISTERED MAIL in this area.

Block 41: Enter the APO or FPO number of the consignee preceded by a “0” or the six letter abbreviation of the receiving activity.

Block 42: Enter “1.”

Block 43: Enter the seal number of the registered pouches or the registered numbers of the OSPs in the dispatch.

Block 44(a): Enter “1” after each piece of registered mail.

Block 44(b): Enter the weight of each piece of registered mail.

### **OPNAV FORM 5110/9**

When mail will be transported by COD flight or opportune aircraft, the mail should be manifested on OPNAV Form 5110/9 (see figure 9-20). The form is self-explanatory and may be used for all classes of mail. However, you should use a separate OPNAV Form 5110/9 for manifesting registered mail (see figure 9-21).

When you prepare the form, stamp the original and each copy with the APDS in the date block and sign it. For record purposes you should make sure that enough copies are made to provide copies to all concerned units. For example, if a dispatch is being prepared for several fleet units, each unit should receive a copy of the manifest, the loadmaster should have a copy, and your office must have a copy signed by the loadmaster. You must retain signed copies of manifests used to dispatch registered mail for 2 years. Signed copies of manifests used to dispatch regular mail are retained for 6 months only. After these respective time periods, if no claim or mail tracer has been initiated, the forms may be destroyed.

OPNAV Form 5110/9 may also be used to document mail transported for delivery or dispatch to or from other postal activities by truck.

Generally, when a ship arrives in a port where an FMC or MPO is located, the mail for the unit is dispatched by truck to the pier or fleet landing. When

dispatching a unit’s mail by truck, you should prepare OPNAV Form 5110/9 in triplicate, and retain the signed triplicate suspense copy in the post office. The clerk who delivers the mail signs the triplicate copy and obtains the required signatures and date of delivery on the original and duplicate copy(s) of the OPNAV Form 5110/9 when the mail is delivered to the respective unit(s). The original should be given to the clerk accepting delivery for the unit. The duplicate copy of OPNAV Form 5110/9 is retained by the delivering FMC or MPO, and the triplicate suspense copy with the dispatching clerk’s signature is destroyed.

In cases where shipboard MPOs are operated by only one clerk, a suspense copy of OPNAV Form 5110/9 is also required when mail is transported to an FMC or MPO.

*Q9-48. Military mail dispatched on a foreign commercial air carrier should be documented on what PS form?*

*Q9-49. What is the distribution of an AV-7 form set?*

*Q9-50. AV-7 dispatch numbers are assigned consecutively, regardless of carrier, destination, or mail category beginning at what point in time?*

*Q9-51. What DD form is used to document military mail dispatched on AMC flights?*

*Q9-52. What OPNAV form is used to document mail dispatched by Navy air transport?*

*Q9-53. When registered mail and ordinary mail are being dispatched via a COD, a separate manifest should be used. (True/False)*

Now turn to appendix 1 to check your answers.

### **RECEIPTING FOR MAIL**

---

**Learning Objective:** *Recall the procedures for receipting for mail from the various types of carriers.*

---

When mail is received from a U.S. or foreign commercial air carrier, you will receipt for the incoming mail by signing the carrier’s copies of the AV-7 that accompanies the mail. Any irregularities must be noted on all copies of the document before you receipt for the mail. Any mail received by AMC or MSC should be receipted for on the accompanying documents (DD Form 1384). Normally, this document is presented by the plane loadmaster in the case of mail

TRANSPORTATION CONTROL AND MOVEMENT DOCUMENT												PAGE NO.				
1. DOC ID	2. TRLR CTR	3. CONSIGNOR			4. COMMODITY SPECIAL HANDLING			5. AIR DIM	6. POE	7. POD		FRA				
TG1		009463			U-1			LON								
8. MODE	9. PACK	10. TRANSPORTATION CONTROL NO.			11. CONSIGNEE			12. PRI	13. RDD	14. PROJ	15. DATE SHPD	16. ETA	17. TR ACCT			
F	PC	0094634001X002XXX			009060			2	4003		4001		0001			
18. CARRIER	19. FLIGHT-TRUCK-VOY-DOC NO.		20. REF		21. REMARKS		22. PIECES		23. WEIGHT		24. CUBE					
AMC							586		1,7580							
a. Transship Point	b. Date Rec	c. Bay	W/Use	d. date Shpd	e. Mode	Carrier	f. Flight- Truck-Voy Doc No.	g. Ref	h. Stow Loc	i. Split	j. Cond	k. Signature-Remarks				
25.																
26.																
27.																
28. CONSIGNEE		29. DATE RECEIVED/OFFERED (Sign)				30. CONDITION		31. REMARKS								
32. DOC ID	33. TRAILER- CON- TAINER	34. CONSIGNOR COMM/ABBR OTHER	35. COMMODITY SPECIAL HANDLING	36. VOY NO	37. POD	38. M O D E	39. TYPE PACK	40. TRANSPORTATION CONTROL NUMBER		41. CONSIGNEE	42. P R I		43. REMARKS AND/OR		44. ADDITIONAL REMARKS OR	
				Air Dim	POE			RDD	ProJ	Slow Loc	Shpd	ETA	Tac	Pieces	Weight	Cube
				a.	b.			a.	b.	c.	d.	e.	a.	b.	c.	

DD FORM 1384, SEP 1998 (EG)

PREVIOUS EDITION IS OBSOLETE.

Figure 9-18.—An example of a completed DD Form 1384, TCMD for ordinary mail.

PCF0918



MAIL MANIFEST					
FROM USS UNDERWAY (CV-66) FPO AE 09561-0001		TO FLEET MAIL CENTER U.S. NAVAL STATION FPO AE 09645		MODE AIR <input checked="" type="checkbox"/> H to H <input type="checkbox"/> SURFACE	DATE
DISPATCHING CLERK: PRINT  PCSN ABLE B. SEAMAN			SIGNATURE		FLT # OR AIRCRAFT #  VRC-24 COD
NUMBER OF PIECES	TYPE CLASS	IDENTIFICATION (SEAL#/SJ#)	ULTIMATE/FINAL DESTINATION	WEIGHT LBS <input type="checkbox"/> KG <input checked="" type="checkbox"/>	REMARKS/COMMENTS
10	LCM		JFK	60.0	
8	APP		JFK	144.8	
11	SAM		JFK	199.1	
1	LCM		USS WEST VIRGINIA	9.1	FFT
TOTAL PIECES			TOTAL WEIGHT		
30			413.0		
THE ABOVE LISTED WAS RECEIVED BY THE DESIGNATED PERSON ON THE DATE SHOWN BELOW					
_____ PRINT _____ SIGN _____ DATE		_____ PRINT _____ SIGN _____ DATE		_____ PRINT _____ SIGN _____ DATE	

OPNAV 5110/9 (Rev 7-91)

PCf0920

Figure 9-20.—An example of a completed OPNAV Form 5110/9 for ordinary mail dispatch.

MAIL MANIFEST					
FROM USS UNDERWAY (CV-66) FPO AE 09561-0001		TO FLEET MAIL CENTER U.S. NAVAL STATION FPO AE 09645		MODE AIR <u>  X  </u> H to H <u>      </u> SURFACE	DATE
DISPATCHING CLERK: PRINT  PCSN ABLE B. SEAMAN			SIGNATURE		FLT # OR AIRCRAFT #  VRC-24 COD
NUMBER OF PIECES	TYPE CLASS	IDENTIFICATION (SEAL#/SJ#)	ULTIMATE/FINAL DESTINATION	WEIGHT LBS <u>      </u> KG <u>  X  </u>	REMARKS/COMMENTS
1	REG	S/213687	NGU	13.6	
1	REG	S/213789	NGU	9.1	
/					
TOTAL PIECES				TOTAL WEIGHT	
2				22.7	
THE ABOVE LISTED WAS RECEIVED BY THE DESIGNATED PERSON ON THE DATE SHOWN BELOW					
<u>          </u> PRINT <u>          </u> SIGN <u>          </u> DATE		<u>          </u> PRINT <u>          </u> SIGN <u>          </u> DATE		<u>          </u> PRINT <u>          </u> SIGN <u>          </u> DATE	
<u>          </u> PRINT <u>          </u> SIGN <u>          </u> DATE		<u>          </u> PRINT <u>          </u> SIGN <u>          </u> DATE		<u>          </u> PRINT <u>          </u> SIGN <u>          </u> DATE	

OPNAV 5110/9 (Rev 7-91)

PCF0921

Figure 9-21.—An example of a completed OPNAV Form 5110/9 for registered mail dispatch.

being transported by AMC and by the driver of the container truck if the mail is transported by MSC.

If command aircraft and trucks are used for the transport of mail, OPNAV Form 5110/9 should be used to receipt for the mail. You should sign and date the form in the appropriate space provided at the bottom of the form. Retain all copies of OPNAV Form 5110/9 for ordinary mail receipts for 6 months in the post office files, 2 years for manifests listing registered mail.

If dispatching mail from one MPO to another, DD Form 1372 may accompany the incoming mail. Complete blocks 22 through 25 at the bottom of the form, as appropriate.

## **AIR CARRIER IRREGULARITIES AND REPORTING PROCEDURES**

Mail-handling irregularities are failures by air carriers to comply with USPS regulations concerning the transportation of mail. When air carriers fail to comply with rules and regulations issued by USPS, the carriers are subject to penalty action. Reportable and nonreportable irregularities are defined in the DOD Postal Manual, DOD 4525.6-M, Volume I, and in USPS Handbook T-7. The processing procedures for reporting mail-handling irregularities depend upon the type of air carriers involved.

### **PS FORM 2759 FOR U.S. COMMERCIAL CARRIERS**

Air carriers providing mail transportation services have specific responsibilities for the proper handling and care of mail in their custody. Failing to comply with the carriage rules and conditions set by the USPS subject them to penalty action.

When mail is mishandled by an air carrier employee, agent, or representative, PS Form 2759, Report of Irregular Handling of Mail (see figure 9-22) must be prepared. The PS Form 2759 is primarily used as a management tool for military postal officials, air transportation managers, and air carrier officials responsible for the proper handling of mail in air transportation channels.

PS Form 2759 is also used to determine and levy appropriate financial penalties against a U.S. air carrier. The purpose of assessing penalties for mail handling irregularities is to focus the air carrier's attention to an unsatisfactory condition that requires corrective action. Although foreign-flag air carriers

are not subject to financial penalties, a PS Form 2759 must be prepared each time an irregularity occurs.

The following definitions explain categories of mail handling irregularities:

- **Failure to load at origin:** The failure to load mail tendered at origin on the flight indicated on the routing label and/or dispatch documents. If the amount of mail tendered to a carrier exceeds the lift capacity of the flight for any reason, a PS Form 2759 should be prepared documenting the excess tender. In this situation, the PS Form 2759 should indicate that a penalty assessment is not recommended.
- **Delivery to wrong destination:** Delivery to a military postal authority at a destination other than that shown on the routing label or dispatch documents.
- **Delayed ground delivery:** The failure to deliver (after the arrival of the flight) incoming mail to a military postal official within the time allowed, which should not exceed 6 hours.
- **Failure to arrive as intended:** Delivery to the military postal facility at the correct destination either on the correct flight that arrives later than planned or on a flight other than the flight designated on the dispatch instructions.
- **Failure to protect:** Failure of a carrier to protect and safeguard mail from inclement weather, loss, depredation, or other hazards while under the custody and control of the carrier. Failure to protect includes:

failure to prevent unauthorized persons from having access to the mail;

allowing mail to be exposed to adverse weather, such as high winds, rain, sleet, or snow; and

failure to transport mail on the ground in carts, containers, or other vehicles securely enclosed to protect the mail from loss or depredation.

**NOTE:** Any pouch, tray, or outside piece of mail that is found unattended and out of the control of an air carrier is included in the failure to protect category of mail handling irregularities. This category also includes instances where an air carrier fails to notify the military postal facility of flight delays in excess of 2 hours, flight cancellations, flight diversions, or emergency changes in the schedule of any flight on which mail is transported

or has been tendered for transportation by a military postal facility.

- Failure to transfer: Mail not transferred between designated flights of the same carrier or between designated flights of two carriers.
- Missing mail: When the number of pieces of mail delivered to a postal facility is less than the number indicated on the PS Form 2942-A. In this instance, the mail must be assumed to be missing and tracer action initiated. Missing inbound mail will not be reported on PS Form 2759 until the origin dispatching office verifies that the pieces were in fact dispatched and documented properly.
- Missing AV-7: When an air carrier delivers mail to a postal facility or another air carrier for transfer without the required dispatch documents (PS Form 2942-A).

Prepare PS Form 2759 in an original and two copies. Specific instructions for completing PS Form 2759 are on the reverse side of the form. However, the following serve as reminders when completing the form.

- TYPE OR PRINT LEGIBLY with a ballpoint pen (black ink).
- Check the appropriate box indicating the correct irregularity code corresponding to the specific mishandling reported.
- Provide accurate information in each of the appropriate spaces provided on the form. Include the proper category of mail (e.g., Express, First-Class, Priority, MOM, SAM, PAL) in the "Class" column.
- Include a sufficient explanation to substantiate the type of irregularity noted and fully describe the circumstances involved.
- Show all weights in kilograms.
- Use a separate PS Form 2759 for each reportable irregularity. Each PS Form 2759 will record only one irregularity code.

Prepare PS Form 2759 as follows:

Block 1: Enter the three-letter alpha code of the reporting facility. For example, if the Rome AMT was reporting the irregularity, then it would be ROM.

Block 2: Enter the date (YY/MM/DD) the report is actually made.

Block 3: Leave blank. The supervisor will complete this block, if applicable.

Block 4: Pre-printed form serial number.

Block 5: Enter the last name and first initial of the person initiating the report.

Block 6: Check the box labeled Military.

Block 7: Intended Flight: The intended flight is the original, planned routing of the mail. Enter the flight number, the scheduled leave and/or arrival time, and the date of the intended flight.

Block 8: Actual Flight: Enter the actual flight number, time, and date to which the mail was dispatched or from which the mail was received.

Block 9 & 10: Mark only one code for each PS Form 2759 initiated.

Block 11: Details: The information entered here reflects the number of pieces, and weight of the mail; container type, class of mail (use the letter "G" if the mail is mixed and it is not feasible to count individual pieces by class); three-letter code of the office of origin and destination; and the dispatch number which is the AV-7 control number.

- The explanation should be specific (who, what, when, where, why, and how) in detailing the circumstances which may have had a direct effect on the mishandling. Also include the disposition of the mail.
- The postal supervisor's signature serves as an indication that the form has been reviewed for completeness and accuracy and the date of the notification is entered in this block.
- Check the block for lower priority on board when it can be substantiated that freight has been loaded, which displaces mail.

Block 12: Leave blank. The Postal Officer in Charge (reviewing official) completes this portion of the form. The reviewing official must indicate, by checking the appropriate block, whether or not a penalty assessment is recommended.

## **AIR MOBILITY COMMAND CARRIERS**

When mail is transported from the United States to an overseas destination via AMC, any irregularity should be reported by naval message to the appropriate JMPA. The message should include a statement reporting the nature of the error, any actions taken to

United States Postal Service  
**Report of Irregular Handling of Mail**

Shaded Areas for International/  
 Military Mail Only

1. Reporting Unit ROM	2. Date of Report 010123	3. 2734-A/2734-B Number	4. Serial Number 695076
--------------------------	-----------------------------	-------------------------	----------------------------

5. Reporting Employee DOE, J	6. Check One <input type="checkbox"/> Domestic <input type="checkbox"/> International <input checked="" type="checkbox"/> Military <input type="checkbox"/> ISAL <input type="checkbox"/> Other
---------------------------------	--

8. Actual Flight			
Flight Number UAA 718	Scheduled Time Leave 1300	Date 010123	Arrival
Flight Number UAA 718	Scheduled Time Leave 1600	Date 010123	Arrival

9. Irregularity Code Code #1 <input type="checkbox"/> Failure to Load at Origin Code #2 <input type="checkbox"/> Delivered to Wrong Destination Code #3 <input type="checkbox"/> Delayed Ground Delivery Code #4 <input type="checkbox"/> Failure to Arrive as Intended (Return to point of occurrence) Code #5 <input checked="" type="checkbox"/> Failure to Protect Circle One: <input checked="" type="radio"/> Safeguard    Notify    Stopped Mail	10. International/Military Only Code #6 <input type="checkbox"/> Failure to Transfer Code #7 <input type="checkbox"/> Missing Mail Code #8 <input type="checkbox"/> Missing CN 38 (old AV-7)  Codes 1 and 6 must have air carrier load summary attached. Air carrier must provide load summary document within 24 hours.
---	---

11. Details							Routing Label/Facsimile
Pieces	Weight	Container	Class	Origin	Destination	Dispatch Number	
30	79.4		APP	ROM	JFK	095	
45	136.1		SAM	ROM	JFK	095	
Total 75	Total 215.5	Total					

Explanation ON 23 JAN 01, 1530 HRS. I OBSERVED THE MAIL LISTED ABOVE LEFT ON THE FLIGHT LINE UNATTENDED. AIR CARRIER REPRESENTATIVES DID NOT MAKE ANY ATTEMPT TO SAFEGUARD THE MAIL. THE MAIL WAS TENDERED TO THE AIR CARRIER TODAY AT 1230 HRS. WHEN THE FLIGHT DEPARTED, THERE WAS NO FREIGHT ON BOARD.

Postal Supervisor's Signature and Date <i>John Doe</i> 23 Jan 01	<input type="checkbox"/> Lower Priority on Board <input type="checkbox"/> Attached Documentaion
---	--

12. Adjudication	
<input type="checkbox"/> Recommended	<input type="checkbox"/> Not Recommended
Reason Not recommended	
<input type="checkbox"/> Weather <input type="checkbox"/> Mechanical <input type="checkbox"/> Weight and Balance <input type="checkbox"/> Air Traffic Control <input type="checkbox"/> Bulk Out <input type="checkbox"/> Misconnect <input type="checkbox"/> Information Only <input type="checkbox"/> Other:	
Reviewing Official Signature and Date	Carrier Representative

Figure 9-22.—An example of a completed PS Form 2759, Report of Irregular Handling of Mail.



correct the error, and recommendations that would prevent recurring errors.

For errors occurring in dispatches originating in overseas areas, the commanding officer of the dispatching activity should be notified by an electrical message for corrective action.

*Q9-54. What PS form is used to report air carrier irregularities by U.S. commercial air carriers?*

*Q9-55. What procedure should you follow when reporting irregularities of mail handling by an AMC carrier?*

Now turn to appendix 1 to check your answers.



## CHAPTER 10

# CLAIMS AND INQUIRIES

In addition to regular postal duties, a military postal clerk will be confronted frequently with postal concerns, and problems of the public. A concern or problem may take the form of a claim, an inquiry, or a complaint. This chapter provides helpful information concerning these concerns and problems, including postal instructions governing the procedures to follow in handling claims, inquiries, and complaints and preparation of the applicable forms.

The USPS understands it is difficult to compensate a patron for the loss of sentimental or irreplaceable items, and is always trying to improve the way mail is handled so incidents do not occur again. Each customer of the post office is encouraged to report instances of loss, rifling, and other mistreatment of mail, even when there may be no provision for payment of indemnity.

### INQUIRIES OR COMPLAINTS

---

**Learning Objective:** *Differentiate between inquiries and complaints and the forms required to respond to each.*

---

An INQUIRY is a request for information.

Inquiries are received almost daily regarding mail service to Navy personnel. Inquiries may be received over the phone, in person, or in writing; and they may concern any phase of postal operations. Most inquiries are usually simple questions concerning the speed of mail, the proper method of preparing mail matter, or some other phase of postal operations.

A COMPLAINT is an expression of dissatisfaction, discontent, disappointment, or resentment concerning any postal product, service, or postal personnel.

Mail complaints are attributable, in many instances, to a lack of information or incomplete or incorrect information. The number of mail complaints could be greatly reduced if commanding officers, within security limitations, kept service members and their families informed on probable mail interruptions or delays. This may be done through plan of the day notices, the issuance of family-grams, and holding

predeployment briefings for family members. Family-grams and briefings should explain the reasons for probable mail delays such as ship transit periods between ports, remote operational areas, shifting operational commitments, and adverse weather. A better understanding of what to expect on a deployment can greatly reduce the anxieties of family members and can help reduce the number of complaints from family members and friends.

The continued use of family-grams during deployments and advising the crew of prevailing conditions that may affect mail service will help dispel rumors that cause misunderstandings that lead to complaints.

Information should be provided to naval personnel and their correspondents before and during deployment. Keeping everyone informed enhances the morale of the crew and their correspondents, and saves the Navy money by avoiding unnecessary administrative work in preparing replies to complaints.

When inquiries of a congressional level or other high-level interest are referred by MPSA to commanding officers for investigation, the command should provide the following information as a minimum in its response:

- Summary of an interview with the person or persons involved, outlining any difficulty experienced in receiving or sending mail.
- Any special circumstances that may have affected mail service.
- Evidence of other individuals experiencing similar difficulties.
- If the individual presently receives mail from correspondents and specifically from the person registering the complaint.
- When complaints involve a specific item of mail, an indication if that item was eventually received.
- Correct mailing address of the person involved.
- Average transit time for all classes of mail to and from the address of mailing.

- A statement concerning the quality of mail service.
- Any additional information that will assist in formulating a reply. NOTE: Responses should be provided in the same manner as received within operational considerations.

Commanding officers must make sure they answer all allegations in the complaint. This will eliminate the complaint being returned for additional information.

## FORMS NEEDED

The following is a list of postal service claims and inquiry forms that are needed to file claims for indemnity, process customer complaints, and report mistreatment of mail:

- PS Form 542, Inquiry About a Registered Article or an Insured Parcel or an Ordinary Article.
- PS Form 673, Report of Rifled Parcel.
- PS Form 1000, Domestic Claim or Registered Mail Inquiry.
- PS Form 1509, Sender's Application for Recall of Mail.
- PS Form 1510, Mail Loss/Rifling Report.
- PS Form 2855, Claim for Indemnity-International Registered, Insured, and Express Mail.
- PS Form 3533, Application and Voucher for Refund of Postage and Fees.
- PS Form 3760, Parcel Search Request.
- PS Form 3831, Receipt for Article(s) Damaged in Mails.
- PS Form 4314-C, Consumer Service Card.
- PS Form 6401, Money Order Inquiry (postal card).

When processing claims and inquiries, military postal clerks will use the appropriate form(s) listed above, depending on whether the claim or inquiry is for Domestic or International mail. Detailed instructions for completing these forms are contained in either the Domestic Mail Manual (DMM), the International Mail Manual (IMM), and or the Postal Operations Manual (POM).

Money order inquiries and certain International Mail claims (refer to chapter 9 of the IMM) require the collection of a fee from the customer.

Failure to properly prepare, or make proper disposition of a postal claim or inquiry can delay the results. At all military post offices the postal supervisor or Custodian of Postal Effects (COPE) should assist in completing claim forms, and or review all claims before they are finalized.

## RESPONDING TO MISTREATMENT OF MAIL

Mistreatment of mail is a general term that includes the loss, rifling of, and damage to mail. Customers should be encouraged to report instances of mistreatment of mail even for cases where there are no provisions for payment of indemnity. Inquiries, complaints, and claims may be filed at any post office.

Normally, you will be concerned only with the processing of inquiries, complaints, and claims for domestic mail matter. International inquiries, complaints, and claims are seldom received at MPO's. If you do receive an international claim or inquiry, refer to chapter 9 of the IMM for guidance.

The information in this chapter, along with some on the job experience, will enable you to efficiently process any inquiry, complaint, or claim that you may receive. Remember, filing a claim or inquiry is the right of the mailer or addressee and you, as the postal representative, should always be helpful and treat the customer with the utmost courtesy.

## CONSUMER SERVICE CARD

---

**Learning Objective:** *Recall the procedures for processing customer complaints on PS Form 4314-C.*

---

PS Form 4314-C, Consumer Service Card (see figure 10-1) should be placed in the post office lobby and readily available to all postal customers. The consumer service card is designed to be used by postal customers only for recording complaints, suggestions, information requests, and compliments. Upon completion of the four-part form, the customer retains copy 1 and will mail or give the remaining copies to the post office for action. The custodian of postal effects (COPE) or MPO supervisor must:

- Investigate the reasons for the complaint and obtain resolution, if possible.

- Contact the customer within 24 hours of receipt of the comment or complaint and advise them of the planned action or resolution.
- Provide the customer with a final response within 14 calendar days after receiving the comment or complaint.
- Complete PS Form 1510 (covered later in this chapter) if a PS Form 4314-C is received that alleges loss, non-receipt, or theft of mail, or that mail appears to have been tampered with. Indicate on the consumer service card that PS Form 1510 has been filed. A copy of the PS Form 4314-C must be sent with the PS Form 1510 to the USPS Inspection Service.

The COPE or MPO supervisor should process PS Form 4314-C, as follows:

- Immediately mail the processing center copy (copy 2) under cover to the appropriate FLTCINC postal officer.
- Initial and date the action copy (copy 3) in the lower-right corner after documenting action taken in the “USPS Use Only” section of the form. Include the date (month/day/year) the customer was contacted, who made the contact, and a brief description of the action taken. Then

the form must be forwarded under cover to the appropriate FLTCINC postal officer.

- File copy 4 of the Consumer Service Card alphabetically by the customer’s last name and year of receipt with any letters or attachments. MPO’s must keep copy 4 on file for at least one year.

The consumer service card file should be maintained in a central location. Consumer Service Cards should be recorded on a customer complaint control log. The date a complaint was closed must be entered on the control log. For other information that must be entered on a customer complaint log, refer to section 165 of the POM.

### MAIL LOSS/RIFLING REPORT (PS FORM 1510)

**Learning Objective:** *Recall the procedures for preparing and processing the Mail Loss/Rifling Report.*

PS Form 1510 is a five-page form that consists of parts I through VI. It is used to process inquiries for ordinary and certified mail and may be initiated by either the sender or addressee. The most common use of PS Form 1510 is when ordinary mail (usually letters) does not get delivered.

1 PRINT FIRMLY	2 REMOVE TOP COPY FOR CUSTOMER RECORD (do not separate remaining copies)	3 FILL IN ADDRESS BLANK ON BACK OF LAST CARD	4 MAIL (postage free)
----------------	---	---	--------------------------

U.S. POSTAL SERVICE CONSUMER SERVICE CARD			
Name <b>JOHN DOE</b>	Date (Mo., Day, Yr.) <b>10-16-01</b>	No. <b>M 16 010 864</b>	
Address (Apt./Suite No., No. and Street, City) <b>1301 PAUL ST NORFOLK</b>	State <b>VA</b>	ZIP Code <b>23505-1610</b>	Customer Phone (8 a.m.-5 p.m.) <b>1-757-851-1057</b>
	Is This <input type="checkbox"/> Information Request <input type="checkbox"/> Suggestion <input checked="" type="checkbox"/> Problem <input type="checkbox"/> Compliment		
Did It Involve <input checked="" type="checkbox"/> Delay <input type="checkbox"/> Nonreceipt	If This Is A Problem With A Specific Mailing, Please Complete The Following:		This Section Is For USPS Use Only Recording Employee Name
Damage <input type="checkbox"/> Misdelivery <input type="checkbox"/> Improperly Returned <input type="checkbox"/> Change of Address <input type="checkbox"/> Vending Equipment <input type="checkbox"/> Window Services <input type="checkbox"/> Personnel <input type="checkbox"/> Other	Was It <input type="checkbox"/> Letter <input checked="" type="checkbox"/> Package <input type="checkbox"/> Newspaper/Magazine <input type="checkbox"/> Advertisement <input type="checkbox"/> Electronic Transmission	Was Mailing <input type="checkbox"/> First-Class <input type="checkbox"/> Special Delivery <input type="checkbox"/> Certified <input type="checkbox"/> Registered <input checked="" type="checkbox"/> Insured <input type="checkbox"/> Express Mail <input type="checkbox"/> Other	Date Customer Contacted Customer Contacted By USPS Action
Please Give Essential Facts (If this involves a change of address problem, please include previous address.) <b>PACKAGES ADDRESSED TO ME ARE BEING FIRST DELIVERED TO A JOHN DOE AT NAVAL STATION NORFOLK 23511. THIS HAS OCCURRED THREE TIMES IN THE LAST MONTH.</b>			

PS Form 4314-C, July 1991      THANK YOU. You will be contacted soon by your Post Office.      CUSTOMER COPY - 1

Figure 10-1 An example of a completed PS Form 4314-C, Consumer Service Card.

When PS Form 1510 is initiated, Parts II-D and II-E are immediately sent to the U.S. Postal Service's Inspection Service Operating Support Group (ISOSG), Two Gateway CTR 9th FL, Newark, NJ, 07175-0001.

Then the remaining parts of the form are sent to the Claims & Inquiry Section so a search can be initiated for the article based on the information the customer provided. The form may also have to be routed to a Mail Recovery Center if the article cannot be located and has a value of \$10.00 or more.

### PREPARATION OF PS FORM 1510

If the complaint is for loss, the customer should allow sufficient time for delivery of the article before filing PS Form 1510 (usually a week to 10 days). If the complaint is for rifling, the customer should immediately notify the post office and provide the post office with the envelope or wrapper, if possible. The clerk accepting PS Form 1510 must forward the envelope or wrapper with the PS Form 1510 to the ISOSG.

Postal clerks will complete PS Form 1510 (see figure 10-2). All of the information required on the

form should be completed by printing legibly using a ballpoint ink pen. Typing is not necessary.

Complete PS Form 1510 part II-A as follows:

Block 1: Enter the date the complaint is made.

Block 2: Enter your MPO's FPO Number (e.g., FPO AE 09561-0001).

Block 3: Check the appropriate box for the type of complaint.

Block 4 a-f: Enter the name, complete address, and telephone number of the person who mailed the article.

Block 5 a-f: Enter the name, complete address, and telephone number of the person to whom the article was addressed.

Block 6 a-b: Enter the date and time the article was mailed.

Block 7: Check the box for the appropriate class of mail. If you check "OTHER," then specify the class of mail; e.g., Priority Mail, SAM, PAL, etc.

Block 8: Check the box for the appropriate type of mail. If you check "OTHER," then specify the type of mail; e.g., roll, tube, flat, wooden box, etc.

Part II-A											
U.S. Postal Service											
Mail Loss/Rifling Report											
<b>Note: Use ballpoint pen and press down firmly; you are making five copies.</b>											
1. Complaint Date 06 FEB 01			2. Office Accepting Complaint (City and State) FPO AE 09561-0001						3. Complaint <input type="checkbox"/> Loss <input checked="" type="checkbox"/> Rifling		
4. Article Was Mailed By						5. Article Was Addressed To					
a. Name MRS. A. B. SEAMAN						a. Name SN ABLE B. SEAMAN					
b. Return Address As On Article Mailed 1800 CUSHMAN DR						b. Address As On Article Mailed USS UNDERWAY CV-66					
c. City COLUMBIA			d. State SC		e. ZIP+4 29204	c. City FPO			d. State AE		e. ZIP+4 09561
f. Day Telephone Number (Include Area Code) 1-803-762-8888						f. Day Telephone Number (Include Area Code)					
6. Article Was Mailed						7. Article Was Sent			8. Type of Mail		
a. Date		b. Time		<input type="checkbox"/> 1st-Class		<input type="checkbox"/> Parcel Post		<input type="checkbox"/> Letter		<input checked="" type="checkbox"/> Parcel	
Month 01	Day 27	Year 01	3:00	<input type="checkbox"/> AM	<input checked="" type="checkbox"/> Other (Specify) PRIORITY MAIL		<input type="checkbox"/> Other (Specify)				
9. Special Services											
<input type="checkbox"/> Special Handling		<input type="checkbox"/> Special Delivery		<input type="checkbox"/> Certified		<input type="checkbox"/> Return Receipt for Merchandise					
10. Place of Mailing						Name and/or Address of Location Checked					
<input type="checkbox"/> Main Post Office											
<input checked="" type="checkbox"/> Station or Branch											
<input type="checkbox"/> Contract Station											
<input type="checkbox"/> Residence or Business											
						City and State of Location Checked COLUMBIA SC			ZIP+4 for Location Checked 29204		
11. Contents of Article (Describe in detail, size, color, brand name, serial no., and amount, etc.) 1 MENS LONG SLEEVE SHIRT (BLUE, SIZE LARGE) 1 VALENTINE CARD										12. Value \$35.00	

PS Form 1510, April 1992

PCF1002

PCF1002

Figure 10-2. An example of a completed PS Form 1510, Part II-A.

Block 9: Check the type of special service on the article, if any. For Certified and Return Receipt for Merchandise mail, you must also enter the special service number. For example, 7000 0600 0023 4109 5793 (for Certified mail).

Block 10: Check the appropriate box to indicate the location where the article was deposited or mailed from. Then enter the city, state, and ZIP Code for the location checked. For example, Columbia, SC 29204.

Block 11: Enter a detailed description of the article's content.

Block 12: Enter the content's value. If no value, enter "NO VALUE."

### PROCESS PS FORM 1510

After completing Part II-A from the information the sender or addressee provided, processing PS Form 1510 varies according to the origin of inquiry and type of mail.

The flowcharts for the different types of inquiries listed below are illustrated in chapter 1 of the POM,

and are used to determine what steps to follow when processing PS Form 1510.

- Inquiry Filed by Sender for Ordinary Mail
- Inquiry Filed by Addressee for Ordinary Mail
- Inquiry Filed by Sender for Certified Mail
- Inquiry Filed by Addressee for Certified Mail

Figure 10-3 is an extract from the POM of the first flowchart listed showing the steps to take when an inquiry has been filed by the sender for ordinary mail.

As seen in figure 10-3, the first step would be to send Parts II-D and II-E to the ISOSG; then you would forward the PS Form 1510 to the Office of Mailing (Claims Section) so they can search their loose-in-mails section.

Normally when the sender files the complaint at the office of mailing, a search would be made and depending on whether the article was or was not found, you continue with the steps on the flowchart.

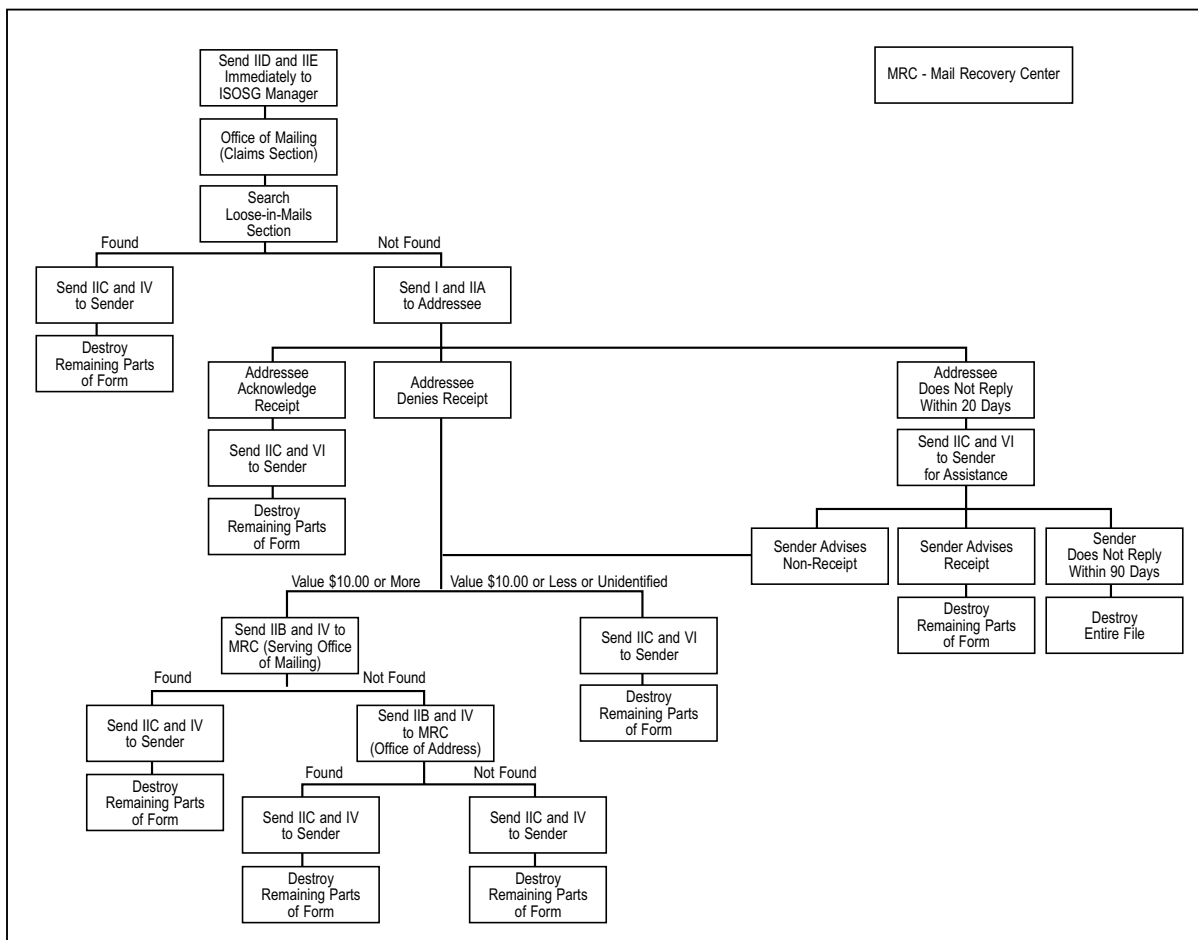

PCf1003

Figure 10-3. An example of a flowchart, PS Form 1510, Inquiry Filed by Sender for Ordinary Mail.

- Q10-1. An inquiry is a request by a customer; made by phone, in person, or in writing on any phase of postal operations. (True/False)*
- Q10-2. Explain some of the ways an MPO could reduce mail complaints.*
- Q10-3. What PS form should be given to a customer who wants to record a postal complaint?*
- Q10-4. The consumer service card contains how many distinct parts?*
- Q10-5. What is the purpose of PS Form 1510?*
- Q10-6. For specific procedural steps in processing PS Form 1510, you should refer to what publication?*

Now turn to appendix 1 to check your answers.

### **DOMESTIC CLAIM OR REGISTERED MAIL INQUIRY (PS FORM 1000) (INDEMNITY CLAIM)**

**Learning Objective:** *Recall the procedures for processing indemnity claims.*

If a customer purchased insurance at the time he/she mailed an article, mailed it registered mail with insurance, or mailed it Express Mail, they can file an indemnity claim to recover the value of the item if it becomes lost or damaged.

For domestic mail, PS Form 1000 is used to file a claim for indemnity. This form is also used to make inquiries only (no indemnity) on uninsured registered domestic mail.

#### **WHO MAY FILE**

A claim may be filed by:

- Only the sender, for the complete loss of a registered, insured, COD, or Express Mail article.
- Either the sender or addressee, for damage to an article, or if some or all of the contents of an article are missing.

#### **TIME LIMITS FOR FILING**

The time limits for filing lost claims are located on the front page of PS Form 1000 (see figure 10-4). These time limits list the time the mailer must wait to file a claim for articles that have not been delivered (complete lost). Do not overlook the bottom of the

chart, which refers to APOs and FPOs. Time limits for filing can also be located in Module S of the DMM. The time limits are:

- 7 days or more after the date of mailing for Express Mail
- 15 days or more for items sent as registered mail
- 30 days after the date of mailing for insured items sent as First-Class and Priority Mail
- 45 days after the date of mailing for insured items sent as SAM or PAL
- 75 days or more after the date of mailing for insured surface items mailed to APOs and FPOs

If an article is received in damaged condition, or some of the contents were lost, then the claim should be filed immediately.

#### **WHERE TO FILE**

Claims for indemnity for loss or damage can be filed at any post office, station, or branch, except for registered merchandise return service, which must be filed at the post office where the merchandise return permit is held.

#### **HOW TO FILE A CLAIM**

A customer may file a claim by presenting evidence of insurance, evidence of value, and proof of loss or damage. (Proof of loss is not required for Express Mail claims.)

#### **Evidence of Insurance**

The customer must first show that insurance, registered, or Express mail service was purchased (evidence of insurance). Either of the following is acceptable:

- The original mailing receipt issued at the time of mailing (reproduced copies are not acceptable). For Express Mail claims, the mailer must present the mailer's copy of USPS Label 11-B.
- The wrapper which must have the names and addresses of both the mailer and addressee, along with the endorsement showing that the article was sent insured, registered, or Express Mail.

**NOTE:** When the original mailing receipt and wrapper are available, it is best to submit the original mailing receipt. If only the wrapper is submitted, indemnity can



**WE APOLOGIZE . . .** if your mail was lost or damaged.

We realize that it is difficult to compensate you for the loss or damage of mailed articles. Despite our best efforts, mail is occasionally damaged or lost. We are constantly improving the way we handle mail so that loss or damage will not occur.

**What you need to file a claim:**

1. Your original mailing receipt for insured, COD, registered, or Express Mail.
2. Evidence of value, such as a sales receipt, invoice or bill of sale, statement of costs for reconstruction of Express Mail documents. Either sender or addressee may furnish evidence of value.
3. Proof of damage or loss:
  - a. **DAMAGE, SOME LOSS OF CONTENTS, OR ONLY THE BOX DELIVERED.** The addressee must present the following:
    - (1) The container, wrapping, packing, and any contents that were received; and
    - (2) The original mailing receipt. *(If you do not have the mailing receipt, the claim form will be forwarded to the sender. The sender must take the claim form and the mailing receipt to a post office for verification.)*

All claims for damage or loss of contents should be **filed immediately**.

- b. **LOSS OF ARTICLE.** For insured or registered articles (not needed for COD or Express Mail), the sender must present one of the following:
  - (1) This claim form signed by the addressee indicating the article was not received; or
  - (2) Written, signed, and dated documentation *(such as a letter from the addressee)* stating the addressee did not receive the article; or
  - (3) If unable to obtain items (1) or (2), you may request a copy of a response from the addressee's post office after a search of its delivery records. You must pay an inquiry fee for this service. *(Fee is refundable if claim is paid. Ask clerk for details.)*

**Time limits for loss claims only:**

Type of Service	Claim may not be filed until . . .	Claim must be filed by . . .
Insured	30 days or more after date of mailing	1 year from date of mailing
COD	60 days or more after date of mailing	1 year from date of mailing
Registered	15 days or more after date of mailing	1 year from date of mailing
Express Mail Service	7 days or more after date of mailing	90 days from date of mailing
Express Mail COD	60 days or more after date of mailing	90 days from date of mailing
SAM or PAL Insured	45 days or more after date of mailing	1 year from date of mailing
APO/FPO Insured	75 days or more after date of mailing	1 year from date of mailing

If you need more information, ask for a copy of Publication 122, *Customer Guide to Filing Domestic Claim or Registered Mail Inquiry*, or the *Domestic Mail Manual S010*.

**Please Detach This Page Before Submitting Claim Form**

Detached From PS Form 1000, April 1997

PCf1004

**Figure 10-4. An example of a front page of PS Form 1000.**

be limited to \$100.00 for insured and registered mail and \$500.00 for Express Mail.

**Evidence of Value**

The customer must submit evidence to establish the cost or value of the article at the time it was mailed. Examples of acceptable evidence are:

- A sales receipt, invoice, or statement of value from a reputable dealer.

- A picture from a catalog showing the value of a similar article.
- A statement from the customer describing the article that was lost or damaged, including the date and where it was purchased, how much it cost, and whether the article was new or used. If the article was handmade, the statement must state the price of the materials and labor used. The statement must describe the article in

enough detail to determine whether the value claimed is accurate.

- Paid repair bills. Estimates of repair costs or appraisals if the claim is for partial damage. The USPS will not make payment for repair costs in excess of the original purchase price.

NOTE: It is best to describe the item in sufficient detail, otherwise the claim may be returned for more information.

Claims for indemnity cannot exceed the amount for which the customer paid insurance, or the amount that the customer actually paid for the article. For example, if a customer purchased an item for \$25.00 and insured the item for \$100.00, they would only be allowed to claim \$25.00 for the actual cost of the item. (They would have over-insured the article.)

Likewise, if the customer purchased the item for \$100.00, and only insured it for \$25.00, then they would only be allowed to claim \$25.00, because that was all the indemnity coverage they purchased.

### **Proof of Damage or Loss**

If the addressee files a claim for damage, the addressee must take the item, box, wrapper and all packaging materials to the post office. If the sender files the claim and the addressee has the damaged article, the claim is sent to the addressee who must then present the item, box, wrapper and all packaging materials to the post office for inspection.

The customer may retain articles that are completely damaged and have little or no salvage value. If the customer does not want the article, the claims clerk in the presence of a witness destroys it.

Articles with salvage value must be retained at the MPO for 90 days, then forwarded to the serving Mail Recovery Center. If the customer's claim is denied, return the article to the customer upon request.

Retain damaged registered articles and packaging in the registered mail section until notified by the USPS Claims Processing Section, Accounting Service CTR, St Louis, MO.

If an article is claimed to be lost, proof of the loss must be submitted before a post office accepts a claim. (Proof of loss is not required for Express Mail). Any of the following is acceptable as proof of loss:

- A claim form (PS Form 1000) completed by the addressee denying receipt or a letter or statement from the addressee, dated at least 30 days (15

days for registered mail) after the date the article was mailed, stating that the addressee did not receive the article. A copy of the letter or statement must be attached to the claim form with evidence of value.

- A statement from the post office of address (the post office of the addressee) stating that a delivery record is not on file. To get this statement, the sender of the article must send a written request to the post office of address with a check or money order for an amount equivalent to the delivery record fee listed in Module R of the DMM. The fee will be reimbursed if the claim is paid. The request must include the names and addresses of the sender and addressee, the insured or registered number, and the mailing date.
- Overseas MPOs receiving fees for claims information must forward them to the serving PFO. Shipboard post offices must forward fees to the NPFO. When forwarding fees to the PFO or NPFO, include a letter of explanation.

### **Receipt for Article(s) Damaged in Mails (PS Form 3831)**

When an MPO retains a damaged article, PS Form 3831, Receipt for Article(s) Damaged in Mails, must be prepared in duplicate (see figure 10-5). Give the original to the customer and attach the duplicate to the damaged article.

Complete PS Form 3831 as follows:

Block 1: Enter the date you received the damaged article.

Block 2: Enter the name of the person from whom you received the damaged article.

Block 3: Enter the special service number (obtained from the mailing receipt or wrapper).

Block 4: Enter the date the article was mailed.

Block 5: Enter the location where the article was mailed (located on the mailing receipt or the postmark on the article).

Block 6: Enter the name of the person who mailed the article.

Block 7: Enter a detailed description of the article(s) received.

Block 8: Enter the name and address of the addressee as shown on the wrapper or mailing receipt.

Block 9: Enter the signature and title of the clerk accepting the claim.

Block 10: Enter the FPO number where the damaged article(s) were turned in.

**PREPARATION OF PS FORM 1000**

Once the customer provides evidence of insurance, evidence of value, and proof of loss (or the damaged item and package) to the post office, assist them in completing PS Form 1000. The information on PS Form 1000 is self-explanatory, and all applicable spaces must be completed.

Assist the customer in completing Section A (see figure 10-6).

Complete Section B (see figure 10-7) or Section C of PS Form 1000 (see figure 10-8) using the instructions on the reverse side of the form.

Prepare PS Form 1000, Section A as follows:

Block 1: Enter the sender's name and address.

Block 2: Enter the addressee's name and address.

Block 3: Check the appropriate box for the service type used for the article.

Block 4: Enter the mailing receipt number. If the mailing receipt is not available, then obtain the number from the label or sticker affixed to the article's wrapper.

Block 5: Enter the date the article was mailed (Mo., Day, Yr.). Obtain this date from the postmark on the mailing receipt or wrapper.

Block 6: This block applies to Express Mail ONLY. If the WAIVER OF SIGNATURE box on Label 11-B is marked, then check YES, otherwise check NO.

Block 7: LEAVE BLANK. This service is not available at MPOs.

Block 8: Check the appropriate box to indicate the reason for filing this claim.

Block 9: Enter a detailed description of the lost or damaged article(s), including whether the article(s) were new or used.

Block 10: Enter the total value claimed for the lost or damaged article(s). If an article has been repaired, enter the amount paid to have the article repaired (not to exceed the actual value of the article).

Block 12a: This block applies to the sender ONLY. When the sender files the claim they must indicate who gets the claim payment by checking the appropriate box.

Block 12b: LEAVE BLANK, unless the customer can provide additional information that will help match the payment check with the claim.

Block 12c-e: These blocks apply to the sender ONLY. The sender signs, dates, and enters their phone number, if available.

Block 13a: This block applies to the addressee ONLY. When the addressee files the claim, they must check the appropriate box.

Block 13 b-g: These blocks apply to COD articles ONLY. LEAVE BLANK.

Block 13h-j: These blocks apply to the addressee ONLY. The addressee signs, dates, and enters their phone number, if available.

U.S. Postal Service		Date
<b>RECEIPT FOR ARTICLE(S) DAMAGED IN MAILS</b>		06 FEB 01 <span style="float: right;">①</span>
Receipt is acknowledged of the following article(s) submitted in connection with a claim for indemnity for damage to the parcel described.		
Received From <span style="float: left;">②</span> SK2 W.T. DOOR		
Registered, Insured, COD, or Express Mail No. <span style="float: left;">③</span> VV 855 491 601 US	Date Mailed <span style="float: right;">④</span> 13 JAN 01	Addressed To (Name and address) <span style="float: right;">⑧</span> SK2 W.T. DOOR USS UNDERWAY (CV-66) FPO AE 09561
Mailed At <span style="float: right;">⑤</span> RIVERSIDE CA 92502	Mailed By <span style="float: right;">⑥</span> MARY D. CHRISTMAS	
Article(s) Received <span style="float: right;">⑦</span> 1 - 24" BRASS LAMP		
		Signature and Title <span style="float: right;">⑨</span> <i>John R. Doe</i> JOHN R. DOE, PC1
		Post Office, State and ZIP Code <span style="float: right;">⑩</span> FPO AE 09561-0001
PS Form 3831, June 1986		(Duplicate to be attached to article(s)) U.S. Government Printing Office: 1993 - 342-723/83787

Figure 10-5. An example of a completed PS Form 3831, Receipt for Article(s) Damaged in Mails.

United States Postal Service  
**Domestic Claim or Registered Mail Inquiry**  
 (Type or Print Legibly with Ball-Point Pen)



A. Completed by Customer (File at any Post Office)						
1. Sender's Name and Address MARY D. CHRISTMAS 3400 BONITA AVE RIVERSIDE CA 92502			2. Addressee's Name and Address (Person or firm to whom article was addressed) SK2 W.T. DOOR USS UNDERWAY (CV-66) FPO AE 09561			
3. Service Type Used for Article (Check one)						<input type="checkbox"/> Express Mail COD
<input checked="" type="checkbox"/> Numbered Insured		<input type="checkbox"/> Registered w/ Insurance		<input type="checkbox"/> Express Mail (Merchandise Insurance)		<input type="checkbox"/> Registered COD
<input type="checkbox"/> Unnumbered Insured		<input type="checkbox"/> Registered w/o Insurance (Inquiry Only - No Indemnity)		<input type="checkbox"/> Express Mail (Document Reconstruction)		<input type="checkbox"/> COD
4. Mailing Receipt Number VV 855 491 601 US	5. Mailing Date (Mo., Day, Yr.) 01, 13, 01	6. Signature of Addressee/Agent Waived? (Express Mail Only) <input type="checkbox"/> Yes <input type="checkbox"/> No		7. If COD, Amount Due Sender \$		
8. Reason for Claim						
<input type="checkbox"/> Article Not Delivered		<input type="checkbox"/> Some Contents Delivered		<input type="checkbox"/> Repair of Damaged Contents		<input type="checkbox"/> Delay of Express Mail Containing Non-Negotiable Documents
<input type="checkbox"/> No COD Remittance Received		<input type="checkbox"/> Container Only Delivered		<input checked="" type="checkbox"/> All Contents Damaged		
9. Description of Lost or Damaged Article(s). (Give brand name(s) where possible and specify value of each. Attach another sheet if necessary. INSTRUCTION: If a damage claim, the ADDRESSEE must immediately present the article, container, wrapping, and packing material to the local post office.) 1-24" BRASS LAMP, PURCHASED FROM SEARS ON 11 JAN 01 FOR \$130.00						
10. Total Value Claimed for All Lost or Damaged Articles (Excluding postage and fees). Attach Evidence of Value (See cover sheet, item 2, for acceptable evidence.) \$ 130.00					11. Nondelivered Items Require Proof of Loss (See cover sheet, item 3b, for acceptable documentation.)	
12. Completed by SENDER ONLY	12a. Send Payment To: <input type="checkbox"/> Sender <input type="checkbox"/> Addressee (Enter address if different from above)			12b. Other Identification (Enter information that will help match the payment check with your claim, e. g., purchase order number.)		
	12c. Signature X			12d. Date Signed		12e. Telephone No. ( )
13. Completed by ADDRESSEE ONLY	13a. Did you receive items listed above? <input checked="" type="checkbox"/> Yes <input type="checkbox"/> No <input type="checkbox"/> Refused		COD Only (Complete items b-g) <input type="checkbox"/> Yes <input type="checkbox"/> No <input type="checkbox"/> Cash <input type="checkbox"/> Check	13b. Did You Pay COD Charge? <input type="checkbox"/> Yes <input type="checkbox"/> No		13c. Check No. (If applicable)
	13d. Date of Check			13e. Amount \$		13f. Where (Post Office at: City, State, and ZIP)
	13g. Date Paid		13h. Signature X W.T. Door		13i. Date Signed 06 FEB 01	
I certify that all information furnished on this form is accurate and truthful. The submission of a false, fictitious, or fraudulent statement may result in imprisonment of up to 5 years and a fine of up to \$10,000 (18 USC 1001). In addition, a civil penalty of up to \$5,000, and an additional assessment of twice the amount falsely claimed may be imposed (31 USC 3802).						

PCF1006

Figure 10-6. An example of a completed PS Form 1000, Section A.

Prepare PS Form 1000, Section B as follows:

Block 1a-f: Enter amount paid for postage, insurance or registered fees, declare actual value, and services purchased in respective blocks, if applicable.

NOTE: To obtain the postage paid when a customer presents the wrapper, you must deduct the special

service fee(s) from the amount of postage affixed to the wrapper.

Block 2: Postmark all copies with the APDS.

Block 3: The accepting clerk signs here.

Block 4: Enter your FPO number. Add "9998" as the 4-digit add-on.

B. Completed by Post Office at Facility Where Claim Filed (See Reverse)				
1a. Postage Paid \$22.45	1b. Insured/Reg./COD Fees \$ 2.50	1c. Declared Actual Value \$	1d. Registered Handling Charge \$	1e. Other Reg./Exp. Fees \$
1f. Other Services (Check all that apply) <input type="checkbox"/> Restricted Delivery <input type="checkbox"/> Return Receipt After Mailing <input type="checkbox"/> Return Receipt			On Damage Claims, the Post Office MUST Describe the Condition of the Item and Container.	
2. Postmark of Accepting PO	3. Signature of Employee Accepting Claim <i>John H. Doe</i>		9. If claim is for damage or loss of contents, were wrapper, container, and article presented? <input checked="" type="checkbox"/> Yes <input type="checkbox"/> No	
	4. Post Office (City, State, & ZIP + 4) FPO AE 09561-0001		10. Location of Damaged Article(s) (Attach description of damage) <input type="checkbox"/> Sender <input checked="" type="checkbox"/> Post Office at (City, State, ZIP + 4): FPO AE 09561-0001	
	5. Finance Number and Unit ID 7000019	6. Telephone Number ( )		<input type="checkbox"/> Addressee
	7. Date Accepted 06 FEB 01	8. Evidence of Insurance or COD <input type="checkbox"/> Mailing Receipt <input checked="" type="checkbox"/> Wrapper		<input type="checkbox"/> Discarded by Post Office
11a. Local Adjudication <input type="checkbox"/> Approved <input type="checkbox"/> Denied		11b. Signature of Approval Authority		11c. Reason for Denial

PCF1007

Figure 10-7. An example of a completed PS Form 1000, Section B.

Block 5: Enter the number 7 and your command's Unit Identification Code (UIC).

Block 6: Enter your post office phone number.

Block 7: Enter the date the claim is accepted.

Block 8: Check the appropriate box for evidence of insurance.

Block 9: This block applies to claims for damage or loss of contents ONLY. Mark the appropriate box.

Block 10: This block applies to claims for damage ONLY. Check the appropriate box to indicate the location of the damaged article(s).

Block 11a-c: Leave these blocks blank.

Prepare PS Form 1000, Section C as follows:

Block 1: Enter the date the article was delivered, if the claim is for complete loss and there is a record of delivery.

Block 2: Enter the date the article was forwarded, if the article was forwarded, and send the claim to the post office where forwarded. Attach a separate sheet showing the current address of the addressee.

Block 3: Forward the claim form to the post office where the article was returned, if the article was returned to sender. Enter in section C, block 3, the date it was returned.

Block 4a: Check box if there is no record of delivery.

Block 4b: Check box if there is no record of delivery or of the article being returned to sender.

Block 5: Postmark this block with the APDS and initial.

Block 6-11: These blocks apply to COD ONLY. LEAVE BLANK.

When you have completed filing the claim, postmark and initial the customer's mailing receipt or the address side of the container presented by the mailer or addressee as proof of insurance for damaged

articles. Advise the customer to hold these items until the claim has been settled.

## PROCESS PS FORM 1000

When processing claims for loss or damage, you may be required to contact the office of mailing or delivery (as appropriate) to complete the PS Form 1000. When processing a claim for loss, attach PS Form 3861-A, Loss Claim, (see figure 10-9) to the PS Form 1000. If processing a damage claim initiated by the sender, attach PS Form 3862, Damage Claim Filed by Sender (see figure 10-10). If the addressee initiates a claim for damage, attach PS Form 3863, Damage Claim Filed by Addressee (see figure 10-11). These forms include instructions for the recipient to follow when completing PS Form 1000.

Distribution instructions for PS Form 1000 are on the reverse side of the form. When PS Form 1000 is completed, it is submitted to:

CLAIMS PROCESSING SECTION  
ACCOUNTING SERVICE CENTER  
PO BOX 80143  
ST LOUIS MO 63180-9432

Additional claims information on mailing, or appeals against payment can be found in Module S of the DMM.

Final review, adjudication, disallowance, or payments of all postal service indemnity claims are made at the Accounting Service Center, St Louis, MO.

## DUPLICATE CLAIMS

A customer must file a duplicate claim within the time limits specified by the USPS (see figure 10-12). To file a duplicate claim, the customer must:

- submit a photocopy of the customer's completed part of the original claim form, or

<b>B. Completed by Delivery Post Office (Attach copy of delivery receipt unless record keeping is computerized)</b>				
1. Date Delivered 06 FEB 01	2. Date Forwarded (See Instructions)	3. Date Returned to Sender (See Instructions)	4a. <input type="checkbox"/> No Record of Delivery	5. Postmark of Delivery PO and initial
4b. <input type="checkbox"/> No Record of Delivery on Return to Sender	If COD, (Also complete items 6-11)		7. Check Number	
8. Check/MO Amt. \$	9. Date Check/MO Sent	10. <input type="checkbox"/> Check/MO Not Issued for COD	11. <input type="checkbox"/> Addressee Did Not Respond to COD Inquiry	

PS Form 1000, April 1997 See Privacy Act Statement on Reverse 1 - St. Louis ASC  
PC11008

Figure 10-8. An example of a completed PS Form 1000, Section C.

## Loss Claim

DATE:

Postmark of Office  
Accepting Claim

TO:



You are requested to check your delivery records within the next five days and complete Section C on the enclosed Form 1000 for the following reason(s):

- ◇ The enclosed Form 1000 reports the possible loss of accountable mail that was directed to your post office for delivery to the addressee shown in Item A2.
- ◇ The enclosed Form 1000 reports the possible loss of accountable mail that was forwarded or returned to the following address:

\_\_\_\_\_  
\_\_\_\_\_  
\_\_\_\_\_  
\_\_\_\_\_

Date Forwarded or Returned: \_\_\_\_\_

Reason Returned: \_\_\_\_\_

\_\_\_\_\_

Please return your response in the pre-addressed envelope provided. Your promptness is sincerely appreciated.

3861-A

PCF1009

**Figure 10-9. An example of a PS Form 3861-A, Loss Claim.**

- request the post office where the claim was filed to process a photocopy of the post office's receipt copy of the original claim form.

*Q10-7. For what reasons can indemnity claims be filed?*

*Q10-8. Who is authorized to file a claim for complete loss of insured, registered, or Express Mail?*

*Q10-9. Claims for insured SAM/PAL mail mailed to or from an APO/FPO may NOT be filed until what time period has elapsed?*

*Q10-10. What three items are required to file an indemnity claim?*

Now turn to appendix 1 to check your answers.

## Damage Claim Filed by Sender

DATE:

TO:

The enclosed Form 1000 was filed by the sender whose name appears in Item 1. It is a claim for damage to the contents of a package mailed to you.

To help the Postal Service settle this claim, please review the Form 1000 and follow the instructions below:

1. Complete **Item 13a** on the enclosed claim form.
2. If you plan to have the article repaired:
  - a) Obtain a signed estimate of repairs or a paid repair bill from a repair shop or dealer.
  - b) Attach the estimate or paid bill to the enclosed claim form and show the amount in **Item 10**.
3. Sign and complete **Items 13h through 13j**.
4. Take the enclosed claim form with the damaged article, wrapper, mailing container, packaging, estimate or repair bill, and any other papers you may have received with this letter to your local post office for inspection.

If you have any questions, your local post office will be glad to assist you.

Your promptness is sincerely appreciated.

\_\_\_\_\_  
(Signature)

\_\_\_\_\_  
(Title)

Enclosure

3862

PCF1010

**Figure 10-10.** An example of a PS Form 3862, Damage Claim Filed by Sender.

### PARCEL SEARCH REQUEST

---

**Learning Objective:** *Determine the requirement for processing a Parcel Search Request.*

---

When the contents of a parcel of domestic origin becomes separated from the wrapper, inform the sender by completing PS Form 3760, Parcel Search Request (see figure 10-13). If the parcel is of foreign origin, send the PS Form 3760, appropriately modified, to the addressee.

### REPORT OF RIFLED PARCEL

---

**Learning Objective:** *Determine the requirement for processing a Report of Rifled Parcel.*

---

Domestic or international parcels, except items sent as registered mail, found to be rifled, should be reported on PS Form 673 (see figure 10-14). PS Form 673 is a four-page set with instructions for completion contained on the reverse side of the form. When completed, the entire set should be forwarded

## Damage Claim Filed by Addressee

DATE:

TO:

The enclosed Form 1000 was filed by the person or firm whose name appears in **Item 2**. It is a claim for damage to the contents of a package you mailed.

To help the Postal Service settle this claim, please review the Form 1000 and follow the instructions below:

1. Complete **Item 10**. Indicate the value of the items described. Attach a copy of the sales receipt. If you do not have a sales receipt, show in **Item 10** the purchase price, the place where purchased, and the approximate date of purchase.
2. Designate to whom payment of the claim should be made in **Item 12a**.
3. Sign and complete **Items 12c through 12e**.
4. Take the original mailing receipt you were given when you mailed the article, and the enclosed claim form to your nearest post office. A postal employee will endorse the receipt and complete Items B1 and B8 on Form 1000.

If you have any questions, your local post office will be glad to assist you.

Your promptness is sincerely appreciated.

\_\_\_\_\_  
Signature

\_\_\_\_\_  
(Title)

Enclosure

3863

PCF1011

Figure 10-11. An example of a PS Form 3863, Damaged Claim Filed by Addressee.

immediately to the USPS Postal Inspection Service. Include the wrapper or carton of the rifled parcel, if totally devoid of contents, and the sack or pouch label. Report each attempted rifling of ordinary parcels, whether partially or completely devoid of contents, or if contents appear intact. Distinguish carefully between rifled parcels and parcels damaged in handling.

### INQUIRY ABOUT A REGISTERED ARTICLE OR AN INSURED PARCEL OR AN ORDINARY ARTICLE

---

**Learning Objective:** *Determine the requirements for processing an Inquiry about a Registered Article or an Insured Parcel or an Ordinary Article.*

---



Mail Type or Service	When to File	
	No Sooner Than (From Original Claim Date)	No Later Than (From Original Mailing Date)
Express Mail	45 Days	6 Months
Insured	45 Days	18 Months
Registered	90 Days	18 Months

Duplicate registered mail and Express Mail claims may not be filed without authorization by the St Louis Accounting Service Center or the Consumer Advocate, USPS Headquarters.

**Figure 10-12. Duplicate claim filing dates.**

PS Form 542, Inquiry about a Registered Article or an Insured Parcel or an Ordinary Article, (see figure 10-15) is used in processing international mail inquiries for the loss

- or delay of outbound registered mail
- or delay of outbound insured parcels
- rifling, damage, or delay of outbound or inbound ordinary parcels
- rifling, damage, or delay of outbound or inbound ordinary postal union mail

As you can see, PS Form 542 has multiple uses. Completion of PS Form 542 is self-explanatory; the fee (if required) is attached to the bottom of the form by adhesive stamps or by meter tape. Send the completed PS Form 542 to the appropriate international claims and inquiries office (ICIO), listed in the IMM. PS Form 542 is used for international mail only.

**CLAIM FOR  
INDEMNITY INTERNATIONAL  
REGISTERED, INSURED, AND  
EXPRESS MAIL**

---

**Learning Objective:** *Determine the requirements for processing a Claim for Indemnity International Registered, Insured, and Express Mail.*

---

Most claims for indemnity can only be submitted after an inquiry has been completed. Claims for indemnity relating to international registered or insured articles must be processed on PS Form 2855, Claim for Indemnity—International Registered, Insured, and Express Mail (see figure 10-16).

Indemnity claims relating to international insured or registered mail are adjudicated by the international

claims and inquiries office responsible for the country involved. When an inquiry fee is required attach it to the upper left corner of PS Form 2855. Normally, a fee will not be required. PS Form 2855 is composed of five sections (front and reverse) and completion of the form is self-explanatory. When a claim is initiated, not all parts of the form may be required to be completed. Refer to the IMM and compare the requirements with your particular case, then have the customer complete the required sections of the form. After PS Form 2855 is completed, check the IMM for accompanying required documents and the address of the appropriate ICIO. PS Form 2855 should be used for international mail only.

**ARTICLES RECOVERED AFTER  
PAYMENT**

---

**Learning Objective:** *Recall the procedures for handling articles recovered after the payment of an indemnity claim.*

---

When a lost registered, insured, or Express Mail article is recovered, the payee who received the indemnity payment may accept the article and reimburse the USPS for the full amount paid if the article is undamaged. If the article is damaged, has depreciated in value, or is missing contents, the payee may accept it and reimburse the USPS an amount determined by the St Louis ASC.

**SENDER'S APPLICATION FOR  
RECALL OF MAIL**

---

**Learning Objective:** *Recall the procedures for processing a Sender's Application for Recall of Mail.*

---

With proper identification, the sender or the sender's representative may recall mail deposited in

U.S. Postal Service <b>Parcel Search Request</b>		
From: Post Office, State, and ZIP Code		
TO: <span style="float: right;"><input type="checkbox"/> A more detailed description is required.</span>		
<b>Complete items below and address to mailer</b>		
Date Found	Found at	By
Addressed To (Name and address)		Type <input type="checkbox"/> Ordinary <input type="checkbox"/> Return Receipt for Merchandise No. _____ <input type="checkbox"/> Insured No. _____ <input type="checkbox"/> C.O.D. No. _____
		Mailing Date
<p>Dear Customer:</p> <p>An empty wrapper with your address was found in the mail and is believed to have been separated from a parcel during handling (see attached address portion of the wrapper.)</p> <p>If the contents of the parcel have not been accounted for and you wish that a search be made for the article(s), please complete the bottom and reverse of this form and return it to the Dead Parcel Branch in the enclosed preaddressed envelope.</p> <p>An accurate and detailed description of each item essential. Give the names or initials (if personalized) and other characteristics such as brand or make of the article, model number, color, size, quantity and kind of material. If you are able to furnish illustrations or pictures, they would be most helpful.</p> <p>If after a thorough search, your merchandise is not located, take this form and wrapper to your local post office for postage refund (Form 3533). Also, if the parcel was sent insured or C.O.D. present this form to your local post office once a search has been completed and request that a claim for indemnity be filed.</p> <p>Experience has shown that proper packaging and including your name and address with the contents inside the parcel in most instances will avoid this inconvenience. To assure our customers the service they deserve, it is suggested that these measures be taken in future mailings.</p> <p>We regret any inconvenience this matter may have caused you.</p>		
Date	Signature	
If found articles should be (Check One) <input type="checkbox"/> Delivered to Addressee <input type="checkbox"/> Returned to Mailer		
Date	Signature of Mailer	Phone No. (Include Area Code)
<b>▶ TO BE COMPLETED BY POST OFFICE ◀</b>		
Results of Search (Check One) <input type="checkbox"/> Articles described above were found and sent on to the addressee <input type="checkbox"/> Articles described above are returned herewith <input type="checkbox"/> Articles not found		Signature  Date
PS Form 3760, July 1989		

PCF1013

Figure 10-13. An example of a Parcel Search Request.

U.S. Postal Service <b>Report of Rifled Parcel</b>		<i>See Instructions on Reverse</i>		1. Date and Hour of Discovery																																																
2. City and State Where Found				3. Postal Unit and Section																																																
4. Sender				5. Addressee																																																
4a. Address (No. and Street, Apt/Suite No.)				5a. Address (No. and Street, Apt/Suite No.)																																																
4b. City		4c. State	4d. ZIP + 4	5b. City		5c. State	5d. ZIP + 4																																													
6. Mailed at				7. Date Mailed		8. Invoice or Order Number																																														
9. Size of Parcel " x " x "		10. COD <input type="checkbox"/> No. _____ <input type="checkbox"/> Ordinary <input type="checkbox"/> Insured <input type="checkbox"/> No. _____		11. Special Delivery <input type="checkbox"/> Yes <input type="checkbox"/> No																																																
12. Parcel Was <input type="checkbox"/> Airmail <input type="checkbox"/> First-Class <input type="checkbox"/> Priority Mail <input type="checkbox"/> Express Mail <input type="checkbox"/> SAM <input type="checkbox"/> PAL <input type="checkbox"/> Third-Class <input type="checkbox"/> Fourth-Class				13. Special Handling <input type="checkbox"/> Yes <input type="checkbox"/> No																																																
14. Exact Location of Discovery																																																				
15. Location in Container <input type="checkbox"/> Front <input type="checkbox"/> Middle <input type="checkbox"/> Rear <input type="checkbox"/> Top <input type="checkbox"/> Bottom				16. Container Locked or Sealed <input type="checkbox"/> Yes <input type="checkbox"/> No Seal No. _____																																																
17. Received From <input type="checkbox"/> Star Route <input type="checkbox"/> Air <input type="checkbox"/> MVS <input type="checkbox"/> Rail _____				18. Name of Carrier, Route and Trip Number																																																
19. Received In <input type="checkbox"/> Pouch <input type="checkbox"/> Sack <input type="checkbox"/> Other _____				20. Label, Placard, Seal Attached <input type="checkbox"/> Yes <input type="checkbox"/> Not Available																																																
21. Pouch, Sack or Outside Labeled To				22. Loaded at																																																
23. If Pouch or Sack Label Not Available, State Origin of Mail Adjacent to the Rifled Parcel																																																				
24. Type of Contents When Mailed																																																				
25. Contents Known to Be Missing (If none, so state)						26. Parcel Forwarded to Addressee <input type="checkbox"/> Yes <input type="checkbox"/> No																																														
27. How Rifled (i.e. Torn, cut by knife, etc.)																																																				
28. Remarks																																																				
29. Supervisor - In Your Opinion, Where Was Parcel Rifled (Name of facility or other location)																																																				
30. Label 97 Completed By		Telephone No.		Title		Tour																																														
31. This Form Completed By		Telephone No.		Title		Tour																																														
<b>Part II - For Inspection Service Use Only</b>	Remarks																																																			
	Installation Responsible for Rifling						ZIP + 4																																													
	Copies to: (Circle)																																																			
<table border="0"> <tr> <td>ATL</td><td>BAL</td><td>BHM</td><td>BOS</td><td>BUF</td><td>CLT</td><td>CHI</td><td>CIN</td><td>CLE</td><td>DEN</td><td>DSM</td><td>DET</td><td>FTW</td> </tr> <tr> <td>HBG</td><td>HTF</td><td>HOU</td><td>IND</td><td>KC</td><td>LA</td><td>MEM</td><td>MIA</td><td>MLW</td><td>NO</td><td>NY</td><td>NWK</td><td>OAK</td> </tr> <tr> <td>PHI</td><td>PHX</td><td>PIT</td><td>POR</td><td>RIC</td><td>STL</td><td>STP</td><td>SD</td><td>SF</td><td>SJU</td><td>SEA</td><td>TAM</td><td>WAS</td> </tr> </table>														ATL	BAL	BHM	BOS	BUF	CLT	CHI	CIN	CLE	DEN	DSM	DET	FTW	HBG	HTF	HOU	IND	KC	LA	MEM	MIA	MLW	NO	NY	NWK	OAK	PHI	PHX	PIT	POR	RIC	STL	STP	SD	SF	SJU	SEA	TAM	WAS
ATL	BAL	BHM	BOS	BUF	CLT	CHI	CIN	CLE	DEN	DSM	DET	FTW																																								
HBG	HTF	HOU	IND	KC	LA	MEM	MIA	MLW	NO	NY	NWK	OAK																																								
PHI	PHX	PIT	POR	RIC	STL	STP	SD	SF	SJU	SEA	TAM	WAS																																								

Figure 10-14. An example of a Report of Rifled Parcel.

**INQUIRY ABOUT A REGISTERED ARTICLE OR AN  
 INSURED PARCEL OR AN ORDINARY ARTICLE**

**RÉCLAMATION**  
 Envoi recommandé, colis  
 avec valeur déclarée ou  
 envoi ordinaire

<b>PLEASE NOTE: A single form is sufficient for several articles in the same category—registered article, insured parcel, ordinary article—mailed at the same time at the same office by the same sender and sent by the same route to the same addressee.</b>		<b>Stamp of the office of origin</b> Timbre du bureau d'origine
<b>Office of origin</b> Bureau d'origine	<b>Date of inquiry</b> Date de la réclamation	
	<b>Date of duplicate</b> Date du duplicata	
	<b>Our reference</b> Notre référence	

**1. INFORMATION TO BE FURNISHED BY THE ADMINISTRATION OF ORIGIN**

Renseignements à fournir par le service d'origine

<b>Reason for inquiry:</b> Motif de la réclamation:	<input type="checkbox"/> Loss Perte	<input type="checkbox"/> Rifling Spoliation	<input type="checkbox"/> Damage Avarie	<input type="checkbox"/> Delay Retard	<input type="checkbox"/> Incomplete Return Receipt A.R. non complété	<input type="checkbox"/> Ordinary parcel Colis ordinaire
<b>Registered article:</b> Envoi recommandé	<input type="checkbox"/> Letter Lettre	<input type="checkbox"/> Print Imprimé	<input type="checkbox"/> Other Autre		<input type="checkbox"/> Ordinary article (Other than parcel) Envoi ordinaire	
<input type="checkbox"/> Insured parcel Colis avec valeur déclarée	<b>Insured for</b> Valeur déclarée de \$	<b>Weight</b> Poids	<b>Value of contents</b> Valeur du contenu \$			
<input type="checkbox"/> Surface	<input type="checkbox"/> Air Mail Avion	<input type="checkbox"/> Special Delivery Express	<input type="checkbox"/> Return Receipt Avis de réception	<input type="checkbox"/> Recorded Delivery Livraison attestée	<b>Registered No.</b> No. recommandé	
<b>Date of mailing</b> Date du dépôt	<b>Office of mailing</b> Bureau de dépôt		<b>Insured No.</b> No. valeur déclarée			
<b>Name and full address of sender /</b> Nom et adresse complète de l'expéditeur						<b>→ PRESS HARD ←</b> <b>YOU ARE MAKING 4 COPIES</b>
<b>Address</b>						
<b>City, State &amp; ZIP Code</b>						
<b>Name and full address of addressee /</b> Nom et adresse complète du destinataire						
<b>Address</b>						
<b>City, State / Country</b>						
<b>Contents (accurate description)</b> Contenu (description exacte)						
<b>Description of exterior (does not concern letter-mail items)</b> Description extérieure (ne concerne pas les envois de la poste aux lettres)						
<b>Facsimile of the address of the article:</b> Fac-similé de la suscription de l'envoi:			<input type="checkbox"/> Attached Annexé	<input type="checkbox"/> Not attached Non annexé		
<b>INFORMATION TO BE FURNISHED BY THE OFFICE OF MAILING AND THE FORWARDING OFFICES</b> Renseignements à fournir par le bureau d'origine et les bureaux réexpéditeurs						
<b>DISPATCH IN WHICH THE ARTICLE WAS INCLUDED</b>	<b>LOCK AND ROTARY, JACKET, SEAL OR CONTROL NUMBER</b>	<b>DATE</b>	<b>FROM</b>	<b>DISPATCHED TO</b>		
<input type="checkbox"/> AIR <input type="checkbox"/> SURFACE						
<input type="checkbox"/> AIR <input type="checkbox"/> SURFACE						
<input type="checkbox"/> AIR <input type="checkbox"/> SURFACE						
<b>Droit de réclamation</b>		<b>INQUIRY FEE</b>		<b>Derechos de reclamación</b>		
<input type="checkbox"/> Return receipt requested at time of mailing, not received. Duplicate attached. No fee required.						
<input type="checkbox"/> Condition under which inquiry is accepted without fee not met. Required fee attached.						

Figure 10-15. An example of an Inquiry about a Registered Article, or an Insured Parcel, or an Ordinary Article.



Claim for Indemnity — International Registered, Insured, and Express Mail (Type or Print)

Case Number

I - General Claim Information (Completed by Person Filing Claim)

1. Name and Address of Sender (No., Street, Apt./Suite No.)		2. Name and Address of Person or Firm to Whom Article was Addressed (No., Street, Apt./Suite No.)	
3. Type of Claim <input type="checkbox"/> Registered <input type="checkbox"/> Insured <input type="checkbox"/> Express Mail		4. Mailing Receipt Number	5. Mailing Date
6. <input type="checkbox"/> Surface <input type="checkbox"/> Airmail		7. Reason for Claim <input type="checkbox"/> 1. Article not Delivered <input type="checkbox"/> 3. Damage <input type="checkbox"/> 2. Some/All Contents Missing	

Number or Quantity	8. Description of Items Which Were Damaged or Missing (State brand names if known. Attach customs declaration if available. Describe condition in which received if damaged.)	√		Value (Allow for depreciation)
		New	Used	

Total Amount Claimed ▶

NOTE: You must submit evidence of value with this claim. Attach purchase receipts or invoices if available.

9. Describe any other items in the article besides those listed above.	10. Pay Indemnity to: <input type="checkbox"/> Sender <input type="checkbox"/> Addressee
	11. Enter Address if Different From Above

12. Signature of Sender (I certify that all information furnished on this form is accurate and truthful. The submission of a false, fictitious, or fraudulent statement may result in imprisonment of up to 5 years and a fine of up to \$10,000 (18 USC 1001). In addition, a civil penalty of up to \$5,000, and an additional assessment of twice the amount falsely claimed may be imposed) (31 USC 3802).

X

13. Phone No.      14. Date

II - Completed by Addressee

15. Did you Receive Items Described Above? <input type="checkbox"/> Yes <input type="checkbox"/> No	16. State Present Location of Damaged Articles
17. Did parcel contain a customs damage/shortage notice? <input type="checkbox"/> Yes (Attach notice) <input type="checkbox"/> No	

18. Signature of Addressee (I certify that all information furnished on this form is accurate and truthful. The submission of a false, fictitious, or fraudulent statement may result in imprisonment of up to 5 years and a fine of up to \$10,000 (18 USC 1001). In addition, a civil penalty of up to \$5,000, and an additional assessment of twice the amount falsely claimed may be imposed) (31 USC 3802).

X

19. Phone No.      20. Date

Figure 10-16. An example of a Claim for Indemnity International Registered, Insured, and Express Mail.

collection boxes or at post offices. PS Form 1509, Sender's Application for Recall of Mail, used for this purpose, (see figure 10-17) is submitted to the postmaster at the office of mailing.

The mailer must pay all expenses of recalling mail (including return postage for other than First-Class

Mail). If mail recalled before dispatch is again presented for mailing, the original stamps are accepted for postage at face value. This provision does not apply to stamps used to pay for registry or insurance fees.

For requests on international mail, if the mail can be intercepted in the United States, it can be withdrawn

U.S. POSTAL SERVICE					
SENDER'S APPLICATION FOR RECALL OF MAIL					
<b>Postmaster:</b> Please intercept and return to me the mail described below:					
<input type="checkbox"/> Letter	<input type="checkbox"/> Express Mail	<input type="checkbox"/> Approx. Size _____	<input type="checkbox"/> Registered No. _____		
<input type="checkbox"/> Package	<input type="checkbox"/> Special Delivery	<input type="checkbox"/> Color _____	<input type="checkbox"/> Certified No. _____		
<input type="checkbox"/> Other (Describe) _____	<input type="checkbox"/> Postage \$ _____		<input type="checkbox"/> Insured No. _____		
			<input type="checkbox"/> C.O.D. No. _____		
			<input type="checkbox"/> Express Mail No. _____		
			<input type="checkbox"/> Return Receipt for Merchandise No. _____		
Hour Mailed A.M. P.M.	Date Mailed	Where Deposited	Time Application Filed A.M. P.M.	Date Filed	
Reason for Recall of Mail					
<b>FACSIMILE LETTER, ADDRESS, OR ADDRESS LABEL</b>					
Address		_____		<input type="checkbox"/> Adhesive Stamp	<input type="checkbox"/> Postage Meter Stamp
<input type="checkbox"/> Handwritten		_____		<input type="checkbox"/> Other	
<input type="checkbox"/> Typewritten		(Return address)			
or		Name _____			
<input type="checkbox"/> Other (Describe) _____		Street and Number _____			
		Post Office _____			
		State and ZIP Code _____			
I deposit herewith \$ _____ to pay for expenses incurred for necessary telegrams, postage, etc., and will reimburse the Postal Service for all costs associated with the recall of the mail described above.					
Signature of Applicant (If signed as agent, include title and firm)			Applicant's Address		Telephone No.
<b>POSTMASTER PORTION ONLY</b>	Application Received By (Name of employee)		Hour Received	Date Received	
			A.M. P.M.		
	Telephoned To	Copies To	Returned By (Name of employee)		
<b>INSTRUCTIONS TO DELIVERY OFFICE</b>					
Please return the above-described mail to this office, if found, or state on reverse of this form the action taken.			▶		
Reply should be addressed to:					
(Postmaster)		(City, State and ZIP Code)			
To:			<b>RECEIPT OF SENDER</b>		
			Date		
			Name		
			Address		

Figure 10-17. An example of a Sender's Application for Recall of Mail.

from the mail. However if the mail has left the United States, it can only be intercepted if the country of destination provides this service.

The USPS does not guarantee success in preventing delivery of all pieces in a withdrawn mailing.

### **APPLICATION AND VOUCHER FOR REFUND OF POSTAGE AND FEES**

---

**Learning Objective:** *Recall the procedures for processing an Application and Voucher for Refund of Postage and Fees.*

---

An application for refund of postage and fees collected for retail services must be initiated by the mailer using PS Form 3533, Application and Voucher for Refund of Postage and Fees (see figure 10-18). MPOs can assist the addressee in preparation of PS Form 3533, but must advise the addressee that the form has to be filed by the mailer.

A postal clerk assists the customer in preparation of PS Form 3533 and reviews supporting documentation. The envelope or wrapper, or the portion of the wrapper, having the names and addresses of the sender and addressee, canceled postage and postal markings, or other evidence of payment of the amount of postage and fees for which a refund is desired must be attached to the PS Form 3533.

The PS Form 3533 and supporting documentation must be sent to the Mail Classification Center serving the MPO.

- For MPOs served by Postmaster, New York:

ACCOUNTABLE PAPER DEPOSITORY  
GPO/JAF BUILDING RM 312  
NEW YORK NY 10194-9615

- For MPOs served by Postmaster, San Francisco:

MAIL CLASSIFICATION OFFICE  
GMF RM 303  
SAN FRANCISCO CA 94188-9599

If the application is not approved, it is returned to the applicant with the supporting papers and an explanatory statement.

### **MONEY ORDER INQUIRY**

---

**Learning Objective:** *Recall the procedures for processing a money order inquiry.*

---

PS Form 6401, Money Order Inquiry, (see figure 10-19) is used to file an inquiry about payment of a postal money order. A customer (purchaser, payee, or endorsee only) may complete, sign, and submit PS Form 6401 for any inquiry on the status of a money order. When the USPS Money Order Branch receives PS Form 6401 from a customer, it reviews USPS records and completes one of the following actions:

- If the money order has not been cashed, a replacement money order will be issued. (A replacement will not be issued until 60 days after the money order purchase date.)
- If the money order was cashed, a photocopy of the paid money order will be issued immediately to the customer filing the inquiry.

Customers may submit PS Form 6401 at any time (there is no waiting period), and must pay the applicable fee for each money order inquiry submitted. For money order inquiry fee rates, refer to Module R of the DMM. Each PS Form 6401 covers only one money order.

When completing PS Form 6401, the customer must present the original money order receipt. The postal clerk will assist the customer in completing PS Form 6401 and then upon payment of the inquiry fee, affix stamps or a postage meter tape on the form where indicated to show the fee was paid. If stamps were used, they must be cancelled with the flag-stamp cancellation device.

Prepare PS Form 6401 as follows: (This form is self-explanatory, and the information is taken from the customer's original money order receipt.)

Block 1: Enter the money order serial number, amount, and issue date.

Block 2: Enter the purchaser's name.

Block 3: Enter the current mailing address of the purchaser.

Block 4: Enter the purchaser's city and state.

Block 5: Enter the ZIP + 4 code.

Block 6: Enter country name (only if unable to provide U.S. address).

Block 7: Customer signs the inquiry.

*Q10-11. When the wrapper of a parcel becomes separated from the contents through normal mail handling, what process would your MPO use to inform the sender?*

United States Postal Service

# Application and Voucher for Refund of Postage, Fees, and Services

(Please type or print legibly.)

**Customer:** Complete in duplicate by typewriter, or print in ink, and submit with envelope, wrapper, or portion having names and addresses of sender and addressee, canceled postage, and postal markings.

**Privacy Act Statement:** The collection of this information is authorized by 39 USC 401, 404, and 1206; Pub. L. 104-134. This information will be used to reimburse you when no service is rendered or when postage and fees are paid in excess of the lawful rate. As a routine use, the information may be disclosed to an appropriate government agency, domestic or foreign, for law enforcement purposes; where pertinent, in a legal proceeding to which the USPS is a party or has an interest; to a government agency in order to obtain information relevant to a USPS decision concerning employment, security clearances, contracts, licenses, grants, permits, or other benefits; to a congressional office at your request; to an expert, consultant, or other person under contract with the USPS to fulfill an agency function; to a Federal Records Center for storage; to the Office of Management and Budget for review of private relief legislation;

to an independent certified accountant during an official audit of the USPS finances; to an investigator, administrative judge or complaints examiner appointed by the Equal Employment Opportunity Commission for investigation of a formal EEO complaint under 29 CFR 1614; to the Merit Systems Protection Board or Office of Special Counsel for proceedings or investigations involving personnel practices and other matters within their jurisdiction; to a labor organization as required by the National Labor Relations Act; to the Department of the Treasury for cross-matching under the Treasury Offset Program; and to a requestor, the name and address of the owner of leased property, or of the payee when different from the owner. Completion of this form is voluntary; however, if this information is not provided, a refund will not be considered.

## Part 1 - Application (Completed by customer)

Customer/Company Name (Print or Type)	Telephone Number (Include area code)
Mailing Address (No., street, ste./apt. no., city, state, and ZIP + 4)	Amount of Refund Request \$
	Signature
	Date of Request

Refund Requested For:

Stamps or Fees (AIC 553)  
Refunded for:

— Clerk PVI Errors (Attach spoiled or misprinted PVI labels to this form.)

— Delivery Confirmation (After 30 days)

— Mail Returned Because of Non-Service or Damage

(Defective or unused stamps may be eligible for exchange but not for a refund.)

Postage Paid for Express Mail Service (AIC 676)

Miscellaneous Non-Postal (AIC 624) (e.g., box key deposits or items originally placed in AIC 126)

Refund of Retail Service Fees (AIC 535) (e.g., PO box/caller service: Enter box no.: \_\_\_\_\_)

Permit Postage and Fees (AIC 528) (e.g., annual bulk mail fees, service failures, or damage to permit imprint mailings)

Postal-Related Products (AIC 608) (e.g., merchandise)

Customer Meter Postage (AIC 526) (Document legible meter postage in Part 3 on the back of this form.)

Precanceled Stamps (AIC 525) (e.g., torn, defaced, or for overpayment of precanceled stamps)

Value-Added Services (AIC 541) (e.g., refunds to mailing agents for performing these services)

Other (Document in Part 4 on the back of this form.)

NOTE: Official Mail refunds are made through the OMAS system at the District Accounting Office.)

## Part 2 - Acceptance Verification (Post office use)

Post Office, State, and ZIP + 4

Acceptance Employee's Signature	Title	Date
---------------------------------	-------	------

PS Form 3533, August 1999

See Reverse for Verification and Additional Information

PCF1018

Figure 10-18. An example of an Application and Voucher for Refund of Postage and Fees.



**1**

Print **Money Order Serial No.** in the blocks below:

Amount of Money Order: Dollars Cents

Issue Date: Year Month Day

Purchaser must **Print Name** within the blocks below:

Print **Current Mailing Address** below:

Second address line if necessary:

Print **City** below: State

ZIP + 4 Code Print **Country Name** (Only if unable to provide US address):

I certify the information on this form is true and agree to repay the Postal Service, upon demand, the amount of the refund if the original money order is cashed by the designated payee, purchaser or financial institution. The rights and remedies set forth in 18 USC 287, 18 USC 1001, and 31 USC 3802 shall be incorporated as if fully set forth. Signature of Purchaser or financial institution representative below:

**POST OFFICE:  
AFFIX STAMPS OR  
METER STRIP HERE**

PS Form 6401, December 1995 Money Order Inquiry

PCF1019

**Figure 10-19. An example of a Money Order Inquiry.**

*Q10-12. What PS form would you use to report a rifled parcel?*

*Q10-14. What PS form is used to process an indemnity claim for an international registered item?*

*Q10-13. What PS form is used to process an inquiry for an ordinary article mailed as postal union mail?*

*Q10-15. What PS form is used to submit an inquiry for a lost money order?*

Now turn to appendix 1 to check your answers.



## CHAPTER 11

# MAIL DIRECTORY SERVICE

Directory service is provided to assist you in delivering mail to personnel, and forwarding or otherwise disposing of mail addressed to personnel no longer at your command. When mail is addressed to a person who is not attached to an activity served by your post office, it is just as important to provide proper disposition of this mail as it is to deliver the mail when the addressee is on board.

Early disposition of mail is the basic purpose of mail directory service. This is true whether the mail is to be delivered on board, forwarded when an addressee has transferred, held pending arrival of the addressee, or given treatment appropriate to certain other categories. Examples of “certain other categories” are mail for casualties and unauthorized absentees.

Each Navy command is required to maintain a mail directory file of all personnel receiving mail through the activity regardless of whether the command operates an MPO. This includes maintaining files on personnel ordered to report and personnel transferred from the activity.

At commands that have an MPO, military postal clerks provide mail directory service as a part of the post office operation. Commands that do not have an MPO, and those receiving mail service through a U.S. civil post office must maintain directory files as part of the unit mail clerk operation or mail orderly system.

Under an agreement between USPS and DOD, DOD agrees to provide directory service for undeliverable-as-addressed military mail and endorse each piece to show a forwarding address or reason for nondelivery. Bear in mind that even though the commanding officer is responsible for directory service, you, as an MPC, are the representative of the commanding officer for postal matters. Thus, you have responsibility for operating and maintaining the directory service for your command.

### POSTAL DIRECTORY FUNCTIONS

---

**Learning Objective:** *Recall the procedures for maintaining directory files and for processing directory mail.*

---

All postal activities providing mail delivery service to individuals should maintain a directory file

for personnel who receive mail through their facility. Normally, MPOs do not keep postal directory cards for personnel who are served through a “mail address only (MAO)” or subordinate unit mailroom. Directory files should include a record of all personnel served, including those on temporary additional duty (TAD), personnel who are due to report, and personnel who have transferred. Directory files should be maintained as one file. A directory for onboard personnel and another file for transferred personnel is not necessary and should be avoided. In addition, MPOs and unit mailrooms should provide directory service for improperly addressed official mail.

### FILING INSTRUCTIONS

The mail directory file consists of OPNAV Form 5110/5, Notice of Change of Address cards (see figure 11-1). The directory cards should be arranged in alphabetical order, by last name, regardless of rank, rating, or status. Use a set of alphabetical separators to divide the cards (see figure 11-2). Last names starting with the same letter are filed behind the same separator.

Sometimes names such as Brown and Browne or Stevens and Stevenson will match letter for letter up to the end of the shorter name. In such cases the name with the fewer letters is to be filed first; thus Brown should precede Browne, and Stevens should be filed before Stevenson. If the last names are exactly alike, use an individual’s first name and possibly his middle name to determine the filing order.

If your directory is large, you may need to use additional separators within letters. For example, S might be broken down into SA, SE, SM, and ST. Last names beginning with the letter S should then be filed after the closest preceding second letter of the separator, thus Schiller would go after SA; Slade after SE; Souder after SM; and Swain after ST. You will learn from experience and the size of your directory whether your card file should be subdivided within letters.

The postal directory file for individuals presently assigned to your command should, as a minimum, contain the complete name, rate/rank, social security



with a person's current address, replace the old cards in the directory file and forward mail as required.

You should also inform transferees the delivery of mail while they are en route to their new duty station is impractical, and advise them against the use of an intermediate activity as an interim address. Suggest to them, instead, that they use a nonmilitary address on their change of address cards.

If a person is transferred for discharge, a complete civilian forwarding address should be furnished. If discharged personnel do not desire to have their mail forwarded to a civilian address, they must indicate this on their directory card and sign it. In this case, their mail is marked NOT DELIVERABLE AS ADDRESSED—UNABLE TO FORWARD and returned to the mailer.

To reduce the amount of mail received after a person transfers, advise transferees to notify correspondents of their new address as soon as possible. The sooner and more often individuals advise their correspondents of the change, the fewer pieces of mail you will have to forward to them. Personnel being transferred should advise publishers

of their new address or notify publishers to discontinue mailings of subscription matter until advised of a new permanent address. OPNAV Form 5110/5 is used for this purpose. Be sure that the publication key number, when available, is entered on the card. Your customer may be able to obtain this number from the old address label. Most publishers and firms specifically request that both the old and the new addresses be furnished, and that an old address label be provided to aid in identifying the subscriber or the customer, and the account. This can be done by taping the old address label to the change of address card. Ensure that the new address is not covered or otherwise made illegible.

**PURGING DIRECTORY CARDS FOR DESTRUCTION**

When an individual is no longer served by the postal activity, code the directory card for destruction so that a minimum of 12 months directory service is provided. For example, if an individual departs in May 2001, you should code the directory card for destruction in June 2002 (see figure 11-3). If an

FORWARDING ADDRESS		PURGE DATE	DATE DEPARTED
<b>NOTICE OF CHANGE OF ADDRESS</b>			DATE
OPNAV 5110/5 (Rev 3-90) S/N 0107-LF-0092500		6/02	23 MAY 01
NAME (Last, first, middle) PISTOL, VERRY C.		RANK/RATE SK1	SOCIAL SECURITY NUMEBR 888-88-8888
<small>PRIVACY ACT STATEMENT: Authority: Title 39 USC and DOD/US Postal Service Agreement, 2 Feb 59            PRINCIPLE PURPOSES: To route or forward (directory) mail. ROUTINE USES: Use by military and civilian personnel in mail functions.            Data are inspected by commanders, postal officers, and military and civilian inspectors. Disclosure is voluntary; however, failure to provide the requested information could result in inability to forward mail.</small>			
NEW ADDRESS (Consult SNDL for address) S-1 DIV USS UNDERWAY (CV-66) FPO AE 09561-0001		OLD ADDRESS (Attach mailing label for publisher) S-1 DIV USS NEVERSAIL (CG-10) FPO AE 09556-0001	
ESTIMATED REPORTING DATE 23 JUN 01		DEPENDENT'S NAME (If applicable) Connie J. Marry L. Tom E.	
SIGNATURE <i>Verry C. Pistol</i>		THIS SPACE FOR POSTAL CLERK	
FORWARD SECOND CLASS MATTER FOR 60 DAYS			
ITEM	YES	NO	
MAGAZINES	<i>no</i>		
NEWSPAPER		<i>no</i>	

\*U.S.GPO: 1993-0-0704-079/80671

AO1103

ESTIMATED DATE PF ARRIVAL  
(PROJECTED REPORTING DATE)

Figure 11-3.—An example of an OPNAV 5110/5 for a member who has departed.

individual was TAD or in student status for 6 months or less, code the directory card for destruction in 3 months.

During the first workweek of each month, the directory file should be screened and all expired cards removed and destroyed. One way to readily identify cards to be removed from the files is to put the number of the month and the year in which the card is to be removed and destroyed to the left of the date on the change of address card. You can also color code the cards for each month, which makes purging easier.

Where do you get the information used to prepare and maintain directory cards?

At most commands, local procedures for personnel reporting and transferring require that they check in and out with the office that maintains the mail directory service, normally the MPO of the command. This way, personnel concerned prepare the necessary cards as required. At certain times, this may not be possible; for example, personnel admitted to a hospital while on leave or liberty because of illness or an accident; personnel who are casualties or unauthorized absentees; or personnel held in custody by civil authorities. In these situations directory personnel

should prepare the cards. Advance copies of orders, and rosters of attached squadrons and/or detachments are all excellent sources of information for obtaining the necessary data to maintain a current mail directory file. You may also be informed of an expected arrival through the receipt of a change of address card that was prepared at another command when a person transferred to your command.

### NAVY DIRECTORY SERVICE PROGRAM

In the previous paragraphs we discussed the procedures for developing a command directory file using OPNAV Form 5110/5. Now we will discuss how commands that have computers in their MPOs can set up their directory system.

The Postal Policy Division at Commander Naval Supply Systems Command developed an automated postal directory program intended for use by all naval activities to provide directory service on undeliverable-as-addressed mail. This program was developed as a replacement for the card file system, (see figures 11-4 and 11-5) and for the numerous locally developed computer programs in use at Navy

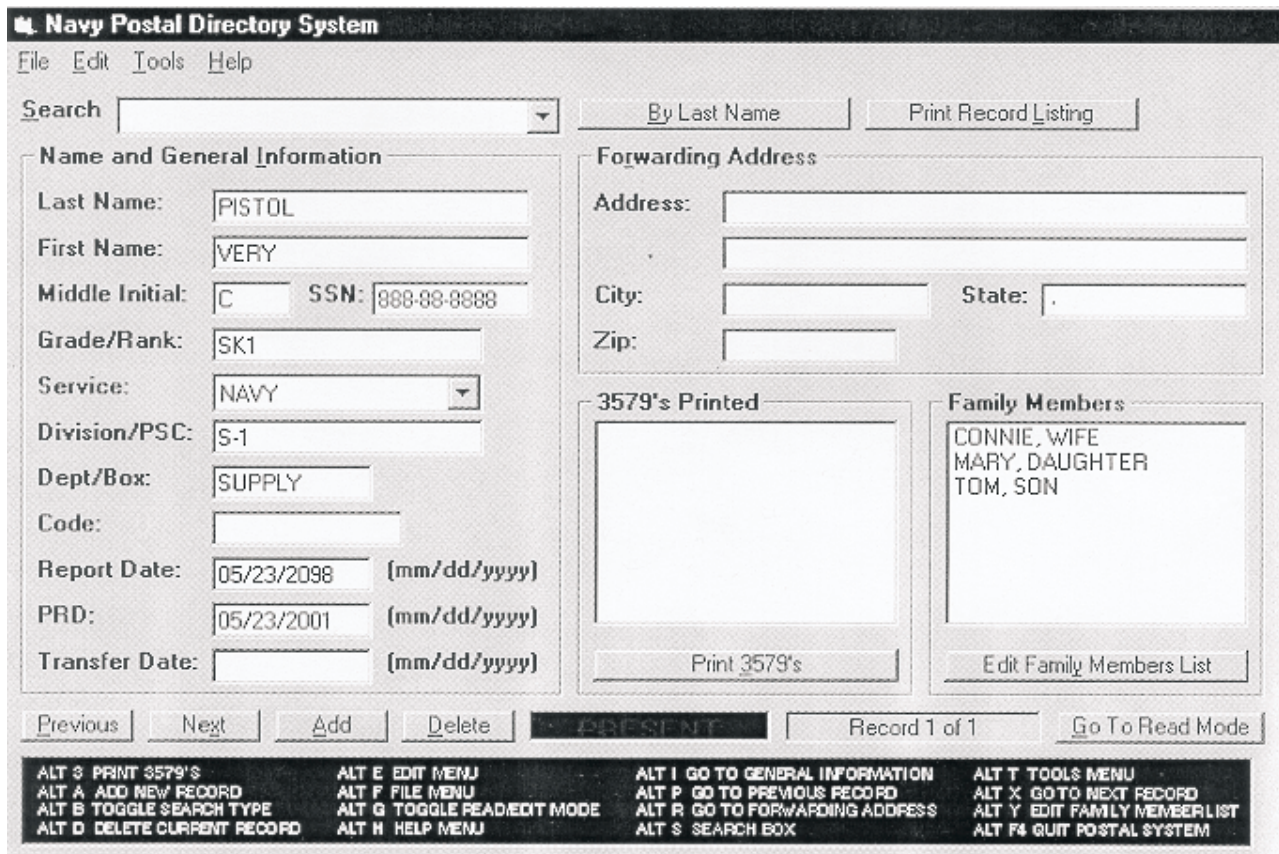

AO1104

Figure 11-4.—An example of an automated record for a person assigned.

**Navy Postal Directory System**  
File Edit Tools Help

Search

<b>Name and General Information</b> Last Name: <input type="text" value="PISTOL"/> First Name: <input type="text" value="VERY"/> Middle Initial: <input type="text" value="C"/> SSN: <input type="text" value="888-88-8888"/> Grade/Rank: <input type="text" value="SK1"/> Service: <input type="text" value="NAVY"/> Division/PSC: <input type="text" value="S-1"/> Dept/Box: <input type="text" value="SUPPLY"/> Code: <input type="text"/> Report Date: <input type="text" value="05/23/2098"/> (mm/dd/yyyy) PRD: <input type="text" value="05/23/2001"/> (mm/dd/yyyy) Transfer Date: <input type="text" value="05/23/2001"/> (mm/dd/yyyy)		<b>Forwarding Address</b> Address: <input type="text" value="S-1 DIVISION"/> <input type="text" value="USS UNDERWAY (CV-66)"/> City: <input type="text" value="FPO"/> State: <input type="text" value="AE"/> Zip: <input type="text" value="01/01/9561"/>	
<b>3579's Printed</b> <input type="button" value="Print 3579's"/>		<b>Family Members</b> <input type="button" value="Edit Family Members List"/> CONNIE, WIFE MARY, DAUGHTER TOM, SON	

**TRANSFERRED**

ALT 3 PRINT 3579'S	ALT E EDIT MENU	ALT I GO TO GENERAL INFORMATION	ALT T TOOLS MENU
ALT A ADD NEW RECORD	ALT F FILE MENU	ALT P GO TO PREVIOUS RECORD	ALT X GO TO NEXT RECORD
ALT B TOGGLE SEARCH TYPE	ALT G TOGGLE READ/EDIT MODE	ALT R GO TO FORWARDING ADDRESS	ALT Y EDIT FAMILY MEMBER LIST
ALT D DELETE CURRENT RECORD	ALT H HELP MENU	ALT S SEARCH BOX	ALT F4 QUIT POSTAL SYSTEM

AO1105

**Figure 11-5.—An example of an automated record for a person transferred.**

post offices. Use of this program reduces the time required to process directory mail.

All Navy post offices, mailrooms, mail centers, and other locations that process personal mail for assigned personnel are required to use this program. Commands that are still using the card file system should transition to the automated system. This program can be downloaded from the NAVSUP website. To access the program, double click on Corporate Services, then (05) Support Services, then (54) Navy Postal. The directory service program can be located under “Programs.”

The system operates in Windows 3.1, WIN 95, WIN 98, and Windows NT systems.

### PROCESSING DIRECTORY MAIL

Directory mail is mail that cannot be delivered as addressed because it bears an incomplete or incorrect mailing address. Mail may be undeliverable, temporarily or permanently, for any number of reasons. It may be incorrectly addressed, the addressee may have transferred, or the mail may be unclaimed or refused.

Mail received at your MPO or unit mailroom for personnel having forwarding addresses on file presents no great problem. The mail is suitably endorsed and promptly forwarded, according to procedures described later in this chapter.

Mail that is undeliverable because it bears an incomplete or an incorrect address is processed against the directory cards. If an individual’s correct address can be determined the mail is delivered. Otherwise it is returned to sender endorsed “ATTEMPTED NOT KNOWN.”

Sometimes it may be difficult to find the proper directory card for a piece of undeliverable mail. This is often because of carelessly written addresses, which are easily misread. The following letters of the alphabet most frequently cause trouble: a and o; h and k; i and e; n and r; n and u.

Suppose you are unable to find the directory card for Douglas, Thomas. You might also check under Thomas, Douglas (in the event that the names might have been transposed); or check Douglas, Tom or Tommy (in the event that a nickname is used instead of the proper first name). Also be alert for names ending with the letter e, such as Browne, Harte, or Thorne, in

the event that the e was incorrectly added, or was omitted but should have been used. Do not consider any piece of mail undeliverable until you have considered every possible card in your directory file.

Now that you have learned how to set up and maintain your directory files, you are ready to process directory mail. Express Mail must be provided directory service immediately, First-Class and Priority mail within 24 hours of receipt, and other classes of mail as soon as possible after receipt. Directory mail received on weekends or holidays must be processed no later than the next duty day.

First you should separate the mail by classes and categories, such as First-Class letter mail, magazines and newspapers, parcels, and so forth. Then you should put the mail in alphabetical order, since your directory files are maintained this way (for the automated system, this is not necessary). Now that you have everything in order, look up the name of the person in your directory files. If there is a forwarding address on file, the following general guidelines apply:

- Draw a single diagonal line through the incorrect address.
- Make required endorsements neatly and legibly, use the least amount of space as possible on the front of the mail.
- Place the initial forwarding address below and to the right of the original address. If all available space on the front of the mail is used, write OVER on the front and place additional endorsements on the back.
- Gummed labels may be placed over old addresses to give additional writing space if needed. However, the name of the addressee should not be written or stamped over or covered by gummed labels.
- When using the automated directory system, a label printed with the forwarding address must be placed over the incorrect address. However, the name of the addressee must not be covered up.
- If letter mail being directorized bears a bar code, directory clerks must totally obliterate this code. If this code is not obliterated, letter mail being forwarded will be returned because of the USPS automated system, which reads bar codes, not the forwarding addresses.

- If the mail is being forwarded to a military unit, include the due-in date. However, this procedure is not necessary if the date is already past.
- All Priority, First-Class, Standard Mail (A); and Standard Mail (B) articles endorsed ADDRESS SERVICE REQUESTED and FORWARDING SERVICE REQUESTED must be endorsed with a forwarding address if one is available and forwarded to the addressee.
- Priority Mail and Standard Mail (A) and (B) articles being forwarded must be endorsed CHANGE OF ADDRESS DUE TO OFFICIAL ORDERS. However, if the mail bears an endorsement that restricts forwarding, then it should be returned to the mailer.

### THE DIRECTORY SERVICE STAMP

Each piece of mail given directory service, including hold mail, should be stamped on the reverse side of the article with the directory service stamp (see figure 11-6). The directory service stamp should not be larger than 1 1/2 by 1 1/2 inches and should contain the following information:

- The name of the command or activity.
- The date the article was received in the directory section.
- The date the mail was forwarded or returned to the sender.
- The directory clerk's initials.

When using the computerized Navy Directory Service Program, it is not necessary to apply the directory service stamp on the reverse side of articles, because the date the mail was forwarded and the directory clerk's initials print out on the label.

<b>DIRECTORY SERVICE</b>
Name of Command
Date Recd _____
Date Fwd _____
Clerk _____

AOF1106

Figure 11-6.—An example of a directory service stamp.



## HOLDING PERIOD FOR ORDINARY MAIL

Undeliverable mail for which there is an indication that the individual is due to arrive is held for 15 days past the anticipated arrival date. If unclaimed at that time, determine the individual's status by contacting the gaining unit or the military or civilian personnel office, and make disposition accordingly. If there is no status change, return the mail to sender endorsed "ATTEMPTED—NOT KNOWN."

If there is no indication of a due-in date, but you have reason to believe the individual is due to arrive because the mail is being forwarded, the sender has the same last name, or for some similar reason, hold it for 30 days.

- If the mail is still unclaimed at that time, attempt to determine the individual's status through appropriate channels and dispose of the mail accordingly. If mail is still undeliverable, return it to sender endorsed "ATTEMPTED—NOT KNOWN."

All hold mail should be screened against the directory files at least weekly.

## HOLDING PERIOD FOR ACCOUNTABLE MAIL

The retention of accountable mail will be handled as follows:

- Undeliverable Express Mail is held no longer than 5 workdays (less than 5 if indicated by the mailer).
- Undeliverable registered, insured, certified, and return receipt for merchandise mail is held a maximum of 15 days (less than 15 if indicated by the mailer).
- If a return receipt is attached to registered, numbered insured, or certified mail that is to be returned, the reason for nondelivery should be indicated on the return receipt. Leave the return receipt on the article and return the article to the mailer. Registered mail is returned through the registered mail system.

When forwarding or returning accountable mail, indicate disposition of the article on PS Form 3849.

## UNDELIVERABLE-AS-ADDRESSED MAIL

Usually nondelivery of mail is because of one of the following reasons:

- Incomplete, illegible, or incorrect address
- Addressee not at address, moved, or deceased
- Hold mail unclaimed
- Mail refused by the addressee at the time of delivery
- Mail refused by the addressee after delivery

*Q11-1. What is the primary purpose of mail directory service?*

*Q11-2. What Navy commands must provide directory service?*

*Q11-3. What OPNAV form is used as a directory card?*

*Q11-4. In what order are directory cards filed?*

*Q11-5. How long should you maintain a directory card before purging?*

*Q11-6. The directory service stamp should not exceed what size limits?*

*Q11-7. Normally, for what period of time is ordinary mail held past the due-in date of a military member?*

*Q11-8. At least how often should hold mail be screened against the directory files?*

*Q11-9. If no specific hold period is requested by the mailer on a registered mail article, for what maximum period of time should it be held if not deliverable?*

Now turn to appendix 1 to check your answers.

## PROCESSING UNDELIVERABLE-AS-ADDRESSED MAIL

---

**Learning Objective:** *Recall the proper processing procedures for the various classes of mail requiring directory service.*

---

Because directory service is provided differently for each class or type of mail, you will need to identify each piece of directory mail to provide for proper disposition. In this section the procedures to follow when processing each class or type of undeliverable-as-addressed mail will be discussed.

**EXPRESS MAIL/FIRST-CLASS MAIL**

The majority of mail you process in a directory section is First-Class letter mail. To reduce the amount of directory mail received, you should advise service members who are transferring to inform correspondents of their new address when one is available.

All undeliverable Express and First-Class mail (including stamped cards/postcards, and Priority mail) is forwarded as many times as necessary without any additional postage charges (see table 11-1).

**Forwarding**

The bulk of the mail you process will have no endorsement, which means the sender did not endorse the mail with a forwarding or return to sender request.

When forwarding Express or First-Class Mail, the only information required on the address side is a forwarding address and a reporting date, if applicable (see figure 11-7).

When you forward Priority mail, write the forwarding address on the article or print out a computer-generated address label and endorse the

**Table 11-1.—Treatment of Undeliverable-as-Addressed Express, First-Class, and Priority Mail**

RULE	ENDORSEMENT	MILITARY POSTAL DIRECTORY SERVICED SHALL:	MILITARY POSTAL DIRECTORY SERVICED BY THE USPS SHALL:
1	NO ENDORSEMENT	Forward. Endorse all Priority Mail, “Change of Address Due to Official Orders.” If a forwarding address is unknown, return to sender endorsed with reason for nondelivery.	Forward. Endorse all Priority Mail “Change of Address Due to Official Orders.” If a forwarding address is unknown, return to sender endorsed with reason for nondelivery.
2	ADDRESS SERVICE REQUESTED	Forward. Endorse all Priority Mail “Change of Address Due to Official Orders.” Use PS Form 3547 to provide sender with address correction. Charge applicable fee.	Forward. Endorse all Priority Mail “Change of Address Due to Official Orders.” Use PS Form 3547 to provide sender with address correction. Charge applicable fee.
3	FORWARDING SERVICE REQUESTED	Forward. Endorse all Priority Mail, “Change of Address Due to Official Orders.” If a forwarding address is unknown, return to sender endorsed with reason for nondelivery.	Forward. Endorse all Priority Mail “Change of Address Due to Official Orders.” If a forwarding address is unknown, return to sender endorsed with reason for nondelivery.
4	RETURN SERVICE REQUESTED	Do not forward.  Return the piece to sender with the new address or reason for nondelivery attached.	Do not forward.  Return the piece to sender with the new address or reason for nondelivery attached.
5	CHANGE SERVICE REQUESTED	Do not forward.  Return the piece to sender endorsed, “Undeliverable as Addressed.”  Not Available for Express Mail.	Do not forward.  Return the piece to the serving post office endorsed, “Undeliverable as Addressed.”  Not Available for Express Mail.

NOTE: When Express Mail, First-Class Mail (including Priority Mail, stamped cards, and postcards) cannot be forwarded or returned to sender, they are considered “dead mail” (covered later in this chapter).

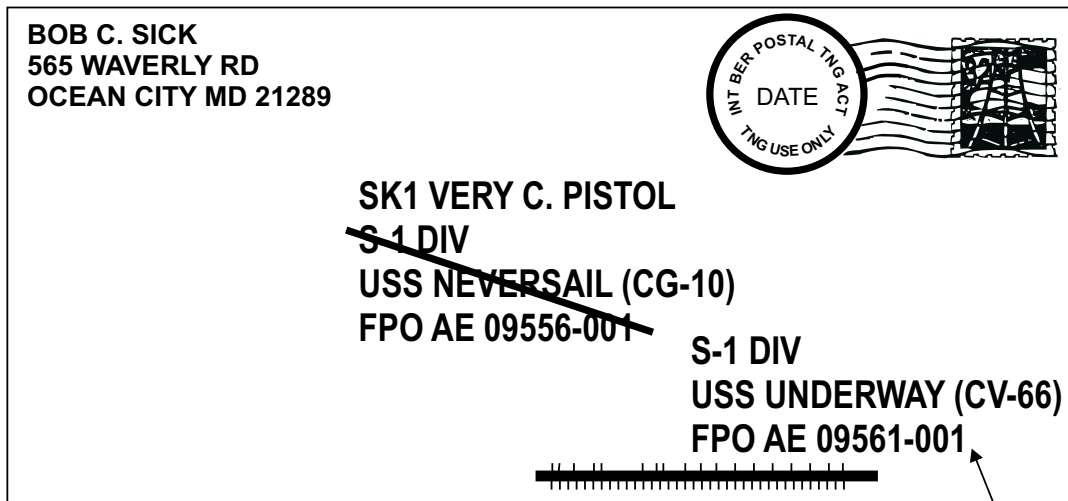

DISPOSITION: **FORWARD TO ADDRESSEE**

For classroom purposes only, write the disposition of the article. See page ii of the handout.

Place the forwarding address below and to the right of old address.

AOF1107

Figure 11-7.—An example of First-Class Mail being forwarded.

article “CHANGE OF ADDRESS DUE TO OFFICIAL ORDERS” (see figure 11-8). This endorsement is necessary to ensure the USPS does not charge the service member for forwarding the article. Use the endorsement “Change of Address Due To Official Orders” only when you forward mail to the addressee.

### Return to Sender

When a forwarding address is unknown or the addressee’s name cannot be found in the directory card

file, return the mail to the sender. Endorse this mail with the “RETURN TO SENDER” stamp and mark the reason for nondelivery “ATTEMPTED—NOT KNOWN,” which means that delivery was attempted, but the addressee is unknown (see figure 11-9).

If the sender has requested by endorsement that mail NOT be forwarded, then the article is returned to the sender endorsed “RETURNED TO SENDER” and “UNDELIVERABLE AS ADDRESSED” (another variation of this endorsement is “NOT

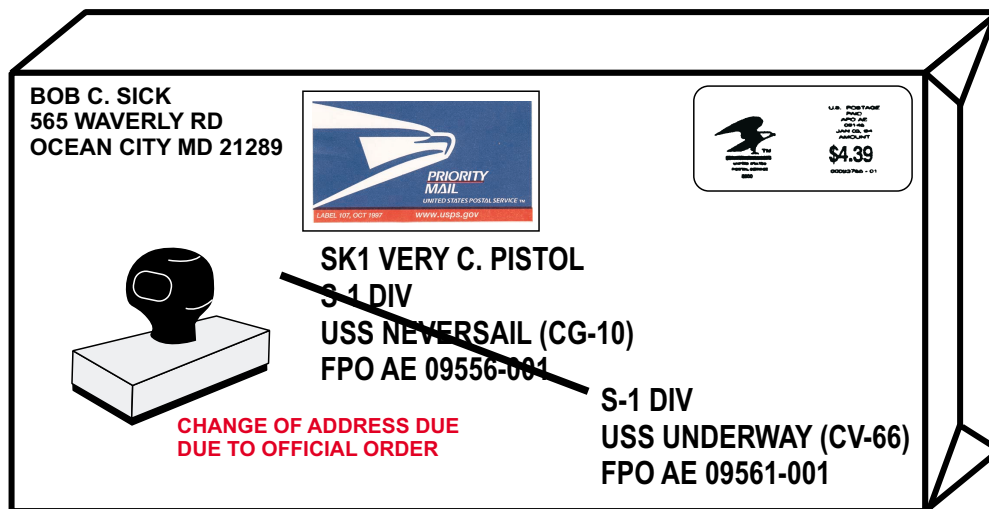

DISPOSITION: **FORWARD TO ADDRESSEE**

For classroom purposes only, write the disposition of the article. See page ii of the handout.

PCF1108

Figure 11-8.—An example of a Priority article being forwarded.

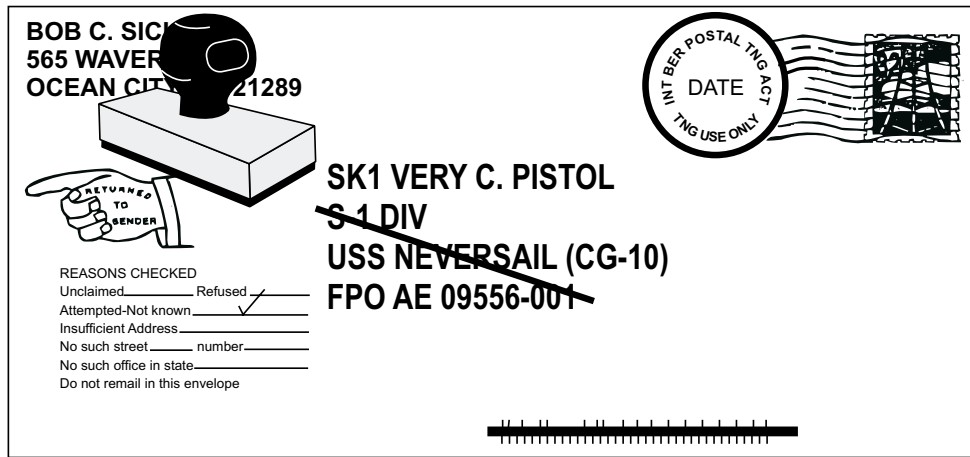

DISPOSITION: **RETURN TO SENDER**

AO1109

For classroom purposes only, write the disposition of the article. See page ii of the handout.

Figure 11-9.—An example of a First-Class article being returned to the sender.

DELIVERABLE AS ADDRESSED UNABLE TO FORWARD”) (see figure 11-10).

## PERIODICALS

Periodicals are publications (e.g., magazines and newspapers) whose primary purpose is transmitting information to an established list of subscribers or requesters. Directory clerks process a large volume of periodicals. The primary reason is because individuals do not inform their publishers that they are moving or have already moved.

The volume of periodicals you process can be reduced by informing all transferring personnel to notify publishers of their new address as soon as possible. This is very important because periodicals are forwarded only for 60 days. After 60 days, newspapers and magazines are distributed to military hospitals, recreation services, dormitories, chaplains, or turned over to the nearest DOD property disposal office as salvage paper, or treated as waste; unless copies are endorsed “ADDRESS SERVICE REQUESTED,” which requires them to be returned to

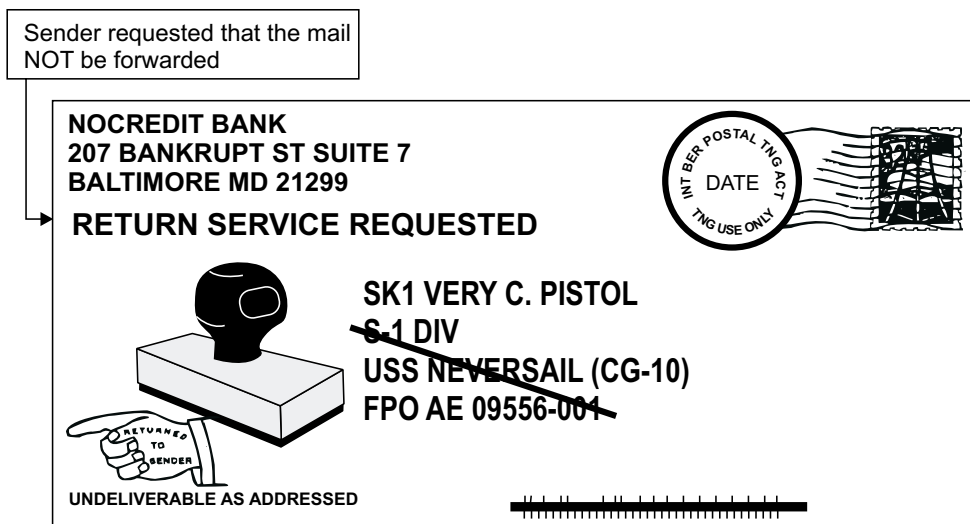

DISPOSITION: **RETURN TO SENDER**

AO1110

For classroom purposes only, write the disposition of the article. See page ii of the handout.

Figure 11-10.—An example of a First-Class article indicating sender’s request that the mail not be forwarded.

the sender with address correction or reason for nondelivery attached (see table 11-2).

### Forwarding Magazines

Forward magazines for reassigned personnel for a period of 60 days after the service member's departure. Directory clerks must endorse this mail: "CHANGE OF ADDRESS DUE TO OFFICIAL ORDERS" and "ADVISE YOUR CORRESPONDENT OR PUBLISHER OF YOUR CORRECT MAILING ADDRESS" (see figure 11-11).

Do not forward magazines after the 60-day forwarding period has expired.

On the first copy of a magazine received after an individual transfers:

- Prepare a PS Form 3579 (see figure 11-12) listing the forwarding address.
- Affix the PS Form 3579 near the old address or address label.
- Cut out the PS Form 3579 and that portion of the publication, wrapper, or envelope containing the old address and place inside USPS envelope EP-1865-D (see figure 11-12).
- Mail the envelope to the publisher (sender) after:

- Entering your command's return address in the upper left-hand corner of the envelope.
- Computing the postage due (refer to the DMM for amount to charge per notice).
- Entering the number of notices enclosed.
- Entering the publisher's (sender's) address in the address space.

Write the individual's name and forwarding address on a label and attach to the article. Endorse the article "CHANGE OF ADDRESS DUE TO OFFICIAL ORDERS," and "ADVISE YOUR CORRESPONDENT OR PUBLISHER OF YOUR CORRECT MAILING ADDRESS." When this has been completed, forward the article to the addressee.

Prepare PS Form 3579 again after the 60-day forwarding period has expired if you continue to receive the magazine.

NOTE: More than one form may be mailed to the same publisher in one envelope; however, postage due must be rated for each form enclosed. For example, if the amount is 50 cents per notice, and you enclose two forms, the postage due will be \$1.00. Three forms will be \$1.50 postage due, etc.

**Table 11-2.—Treatment of Undeliverable-as-Addressed Periodicals**

RULE	ENDORSEMENT	MILITARY POSTAL DIRECTORY SERVICED SHALL:	MILITARY POSTAL DIRECTORY SERVICED BY THE USPS SHALL:
1	NO ENDORSEMENT	Forward for 60 days. Before forwarding, process PS Form 3579. Endorse, "Change of Address Due to Official Orders." If a forwarding address is unknown or after 60-day period, process PS Form 3579 again, then dispose as waste.	Forward for 60 days. Before forwarding, process PS Form 3579. Endorse, "Change of Address Due to Official Orders." If a forwarding address is unknown, or after 60 day period, process PS Form 3579 again. Piece is disposed of by USPS.
2	ADDRESS SERVICE REQUESTED	Forward for 60 days. Endorse, "Change of Address Due to Official Orders." If a forwarding address is unknown or after 60-day period, attach PS Form 3579. Then return to sender with address correction or endorsed with reason for nondelivery and "Postage Due." Do not compute postage.	Forward for 60 days. Endorse "Change of Address Due to Official Orders." If a forwarding address is unknown or after 60-day period, attach PS Form 3579. Then return to sender with address correction or endorsed with reason for nondelivery, and "Postage Due." Do not compute postage.

NOTE: Forwarding Service Requested, Return Service Requested, and Change Service Requested are not available for Periodicals.

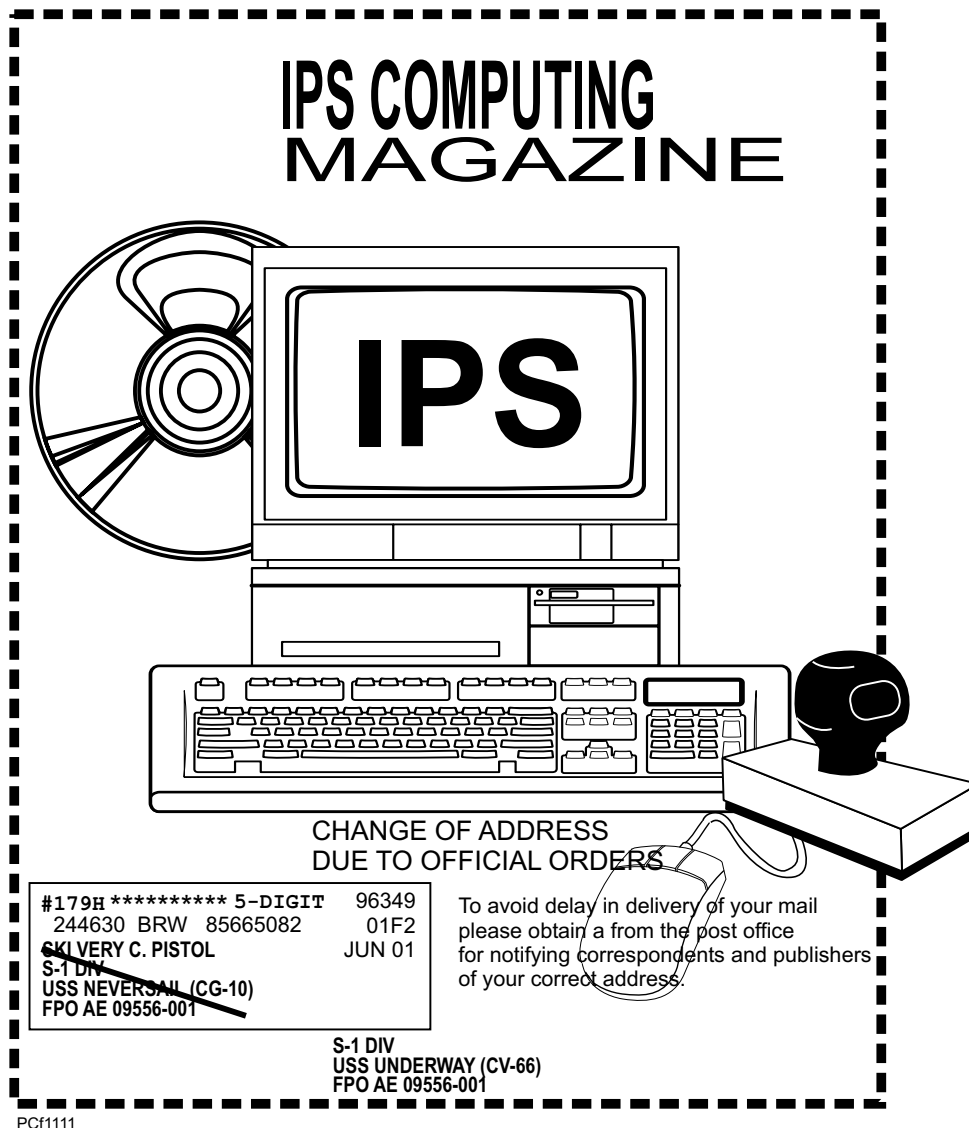

Figure 11-11.—An example of endorsements on a magazine being forwarded.

- Prepare a PS Form 3579 record. The name of the publication and date of notification will be indicated on the directory card (see figure 11-13), or automated directory file (see figure 11-14).
- After the 60-day forwarding period has expired treat the magazine as waste, unless it bears the endorsement “ADDRESS SERVICE REQUESTED.”

### Forwarding Newspapers

Newspapers addressed to personnel who have been reassigned to an area served by the same postmaster are forwarded for a period of 60 days. Directory clerks must endorse newspapers: “CHANGE OF ADDRESS DUE TO OFFICIAL ORDERS” and “ADVISE YOUR CORRESPON-

DENT OR PUBLISHER OF YOUR CORRECT MAILING ADDRESS.”

Newspapers addressed to personnel who have been reassigned to an area NOT served by the same postmaster WILL NOT be forwarded. Process as follows:

- Prepare a PS Form 3579 listing the forwarding address and mark it “NOT DELIVERABLE AS ADDRESSED—UNABLE TO FORWARD.”
- Affix the PS Form 3579 near the old address or address label.
- Cut out the PS Form 3579 and that portion of the newspaper containing the old address and place inside a USPS envelope, EP 1865-D.
- Mail the envelope to the publisher (sender) after you have completed the following:

Undeliverable Standard Mail (A) and (B) and Special Standard Mail (B)		
<input type="checkbox"/> Moved-Left No Address	<input type="checkbox"/> No Such Number	<input type="checkbox"/> No Such Street
<input type="checkbox"/> Attempted not Known	<input type="checkbox"/> Unclaimed	<input type="checkbox"/> Refused
<input type="checkbox"/> Insufficient Address	<input checked="" type="checkbox"/> Not Deliverable Addressed-Unable to Forward	
Initials	Date	Route Number
<b>Moved to the Following New Address:</b>		
Number, Street Apt./Suite No.		
565 WAVERLY RD		
City	<input type="checkbox"/> No Charge	
OCEAN CITY		
State and ZIP+4	<input type="checkbox"/> No Charge	
MD 21289		
PS Form 3579, January 1997		Date
United States Postal Service		30 JUL 01

Mark appropriate reason

Enter the forwarding address and date the mail is processed. If a forwarding address is not available, leave the address portion blank

Enter the Postage Due amount (50 cents per each PS Form 3579 enclosed)

Write your return address

 <b>UNITED STATES POSTAL SERVICE</b> FPO AE 09561-0001	First Class Mail Postage & Fees Paid USPS Permit No. G-10
	<b>POSTAGE DUE 50 ¢</b>
CONTENTS <b>1</b> FORMS 8579	<b>SHIPRECK COMPUTERS INC.</b> Publication <b>P.O. BOX 3309</b> Address <b>SAN DIEGO CA 28230</b> City State ZIP Code

Enter the number of PS Form 3579 enclosed

Write the publication's name and publisher's address

PCF1112

Figure 11-12.—An example of a properly completed PS Form 3579 and EP 1865-D.

<b>NOTICE OF CHANGE OF ADDRESS</b>		DATE
OPNAV 5110/5 (Rev 3-90) S/N 0107-LF-0092500		6/02 23 MAY 01
NAME (Last, first, middle) PISTOL, VERRY C.	RANK/RATE SK1	SOCIAL SECURITY NUMEBR 888-88-8888
PRIVACY ACT STATEMENT: Authority: Title 39 USC and DOD/US Postal Service Agreement, 2 Feb 59 PRINCIPLE PURPOSES: To route or forward (directory) mail. ROUTINE USES: Use by military and civilian personnel in mail functions. Data are inspected by commanders, postal officers, and military and civilian inspectors. Disclosure is voluntary; however, failure to provide the requested information could result in inability to forward mail.		
NEW ADDRESS (Consult SNDL for address) S-1 DIV USS UNDERWAY (CV-66) FPO AE 09561-0001	OLD ADDRESS (Attach mailing label for publisher) S-1 DIV USS NEVERSAIL (CG-10) FPO AE 09556-0001	
ESTIMATED REPORTING DATE 23 JUN 01	DEPENDENT'S NAME (If applicable) Connie J. Marry L. Tom E.	
SIGNATURE <i>Verry C. Pistol</i>	THIS SPACE FOR POSTAL CLERK	
FORWARD SECOND CLASS MATTER FOR 60 DAYS		PS Form 3579 sent to Shipreck Computers Inc. on 3 Jun 01
ITEM	YES NO	
MAGAZINES	<i>YCP</i>	
NEWSPAPER		<i>YCP</i>
		*U.S.GPO: 1993-0-0704-079/80671

AO1113

Indicate on the directory card the name of the publication and date of notification to prevent sending duplicate notifications to publishers

Figure 11-13.—An example of an OPNAV Form 5110/5 indicating a PS Form 3579 was sent.

- Placing your command’s return address in the upper left-hand corner of the envelope.
- Computing the postage due (refer to the DMM for amount to charge per notice).
- Entering the publisher’s (sender’s) address in the address space.
- Make an entry on the directory card or automated directory file that a PS Form 3579 was sent.
- Treat the newspaper as waste.

**Return to Sender**

Return magazines or newspapers to the publisher after the 60-day forwarding period has expired only when they bear the endorsement “ADDRESS SERVICE REQUESTED.” Directory clerks must prepare and attach PS Form 3579 to the outside of the article and endorse these items “RETURN TO

SENDER,” “UNDELIVERABLE AS ADDRESSED,” and “POSTAGE DUE,” but do not compute the postage (see figure 11-15).

**Treat as Waste**

After preparing PS Form 3579 and removing the address label off the publication, directory clerks are authorized to give magazines and newspapers to authorized agencies or treat them as waste.

NOTE: Remember, DO NOT destroy periodicals endorsed “Address Service Requested.” Return these publications to the publisher.

**STANDARD MAIL (A) (BULK RATE)**

This less expensive class of mail is used by businesses and organizations that mail large quantities of mail to advertise their merchandise or services. Presorted Standard Mail (A) consists of circulars, catalogs, income tax booklets, etc., and is easily



**Navy Postal Directory System**  
 File Edit Tools Help

Search

**Name and General Information**

Last Name:

First Name:

Middle Initial:  SSN:

Grade/Rank:

Service:

Division/PSC:

Dept/Box:

Code:

Report Date:  (mm/dd/yyyy)

PRD:  (mm/dd/yyyy)

Transfer Date:  (mm/dd/yyyy)

**Forwarding Address**

Address:

City:  State:

Zip:

**3579's Printed**

**Family Members**

**TRANSFERRED**

ALT 3 PRINT 3579'S    ALT E EDIT MENU    ALT I GO TO GENERAL INFORMATION    ALT T TOOLS MENU  
 ALT A ADD NEW RECORD    ALT F FILE MENU    ALT P GO TO PREVIOUS RECORD    ALT X GO TO NEXT RECORD  
 ALT B TOGGLE SEARCH TYPE    ALT G TOGGLE READ/EDIT MODE    ALT R GO TO FORWARDING ADDRESS    ALT Y EDIT FAMILY MEMBERLIST  
 ALT D DELETE CURRENT RECORD    ALT H HELP MENU    ALT S SEARCH BOX    ALT F4 QUIT POSTAL SYSTEM

AOF1114

Figure 11-14.—An example of an automated directory file indicating a PS Form 3579 was sent.

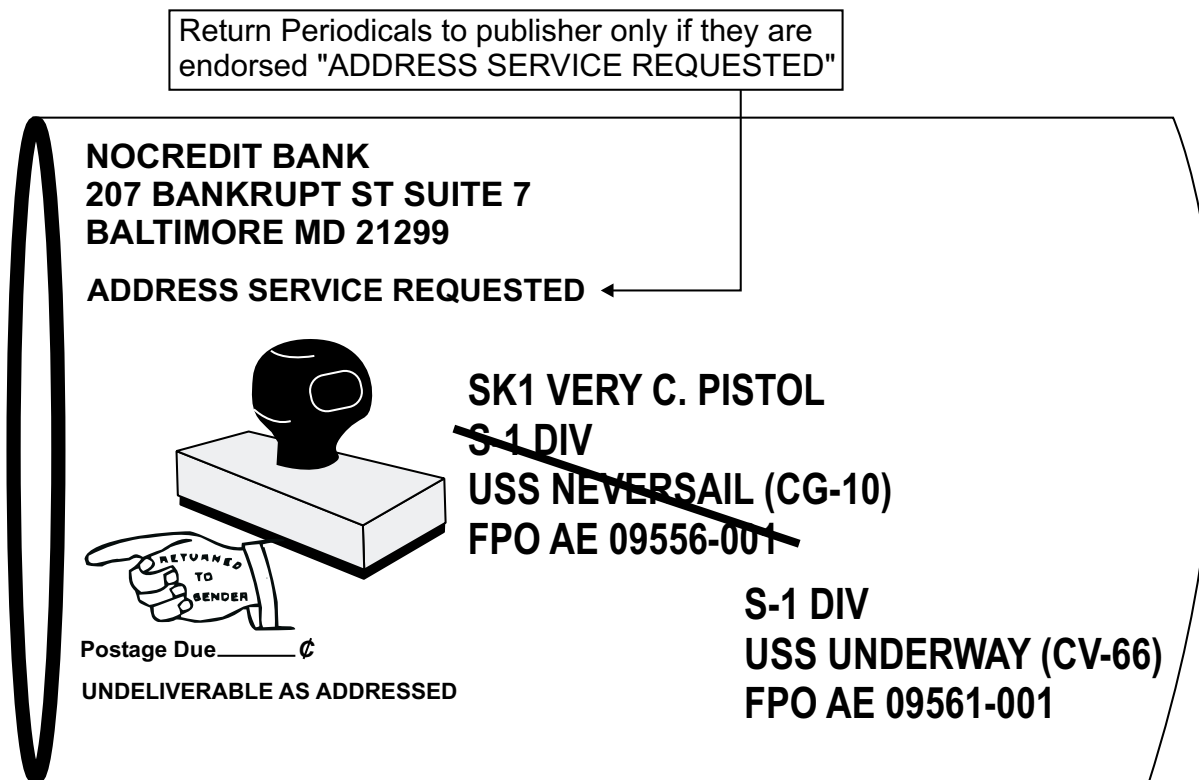

AOF1115

Figure 11-15.—An example of endorsements on Periodicals being returned to the sender.

identified because the articles bear the endorsement “Presorted Standard” or “PRST STD.” Although businesses and organizations pay a lower rate of postage to mail Standard Mail (A) articles, these articles are “mail” and must be processed and treated in accordance with USPS regulations (see table 11-3). Directory clerks must pay attention to mailer endorsements (if any) to prevent incorrect disposition of the mail.

## Catalogs

Catalogs are mailed at the bulk rate of postage and are considered to be of no value. Catalogs that are undeliverable should be disposed of as follows:

- If overseas, the wrapper and/or label should be removed and destroyed. This also applies to

**Table 11-3.—Treatment of Undeliverable-as-Addressed Standard Mail (A)**

RULE	ENDORSEMENT	MILITARY POSTAL DIRECTORY SERVICED SHALL:	MILITARY POSTAL DIRECTORY SERVICED BY THE USPS SHALL:
1	NO ENDORSEMENT	(Unit mailclerks and mail orderlies.) Endorse each piece of mail as “Undeliverable as Addressed,” and return to the serving MPO.  (MPO) Destroy as waste, MPO’s shall not forward or return this mail.	Endorse each piece as, “Undeliverable as Addressed.” Return to the servicing USPS facility.  Piece disposed of by USPS.
2	ADDRESS SERVICE REQUESTED	Forward. Endorse “Change of Address Due to Official Orders.” Prepare PS Form 3547 and send to mailer advising of new address. If forwarding address is unknown, return piece to sender, endorsed with reason for nondelivery and “Postage Due.” Do not compute postage.	Forward. Endorse “Change of Address Due to Official Orders.” Prepare PS Form 3547 and send to mailer advising of new address. If forwarding address is unknown, return piece to sender, endorsed with reason for nondelivery and “Postage Due.” Do not compute postage.
3	FORWARDING SERVICE REQUESTED	Forward. Endorse “Change of Address Due to Official Orders.” If a forwarding address is unknown, return to sender endorsed with the reason for nondelivery and Postage Due. Do not compute postage.	Forward. Endorse “Change of Address Due to Official Orders.” If a forwarding address is unknown, return to sender endorsed with the reason for nondelivery and Postage Due. Do not compute postage.
4	RETURN SERVICE REQUESTED	Return piece with new address or reason for nondelivery attached. Endorse Postage Due. Do not compute postage.	Return piece with new address or reason for nondelivery attached. Endorse Postage Due. Do not compute postage.
5	CHANGE SERVICE REQUESTED	(Unit mailclerks and mail orderlies.) Endorse each piece of mail as “Undeliverable as Addressed,” and return to the serving MPO.  MPO prepares PS Form 3547 and sends to mailer then piece disposed of.	Prepare PS Form 3547 and send to mailer. Endorse each piece as, “Undeliverable as Addressed.” Return to the servicing USPS facility.  Piece disposed of by USPS.
Standard Mail (A) is forwarded and returned to domestic addresses only.			

those catalogs bearing the endorsements ADDRESS/FORWARDING/RETURN SERVICE REQUESTED. Catalogs may then be given to any authorized customer or placed in the military post office lobby for customer use.

- If in the United States, you should follow the instructions listed in table 11-3.

### Income Tax Booklet

Income tax booklets that are undeliverable as addressed should be released to the appropriate local office designated by the commanding officer. Normally, the legal officer for the command provides this service. Before releasing undeliverable income tax booklets, you should remove and destroy all address labels. Postal bulletin notices pertaining to nonrelease of income tax booklets do not apply at military post offices.

### STANDARD MAIL (B)

Standard Mail (B), as learned in a previous lesson, is also known as SAM or Parcel Post. It contains matter, other than personal correspondence, weighing 16 ounces up to 70 pounds and consists mainly of parcels. Process Standard Mail (B) in accordance with USPS instructions (see table 11-4).

### VOTING AND BALLOTING MATERIAL

Voting and balloting material should be provided directory service immediately when it cannot be

delivered as addressed. If the material is undeliverable and a forwarding address is not known, it should be returned to the mailer immediately, marked with the reason for return. Do not hold for personnel due to arrive unless they are due in 30 days after receipt of the balloting material.

### MAIL FOR PERSONNEL CONFINED

Instructions concerning mail for personnel confined for disciplinary reasons are in the *Department of the Navy Corrections Manual* (SECNAVINST 1640.9).

Mail for personnel whose forwarding addresses are on file should be endorsed and promptly forwarded. The forwarding address should show a post office box, or a street address, but should not indicate that the person is confined.

### ADDRESSEE NOT AUTHORIZED MILITARY POST OFFICE PRIVILEGES

Mail received at overseas locations addressed to personnel not authorized MPO privileges should be endorsed ADDRESSEE NOT AUTHORIZED MPO PRIVILEGES and returned to the mailer. Organizations and personnel authorized use of the MPS must not use it as intermediaries for any person or organizations not specifically authorized MPO privileges. If mail is addressed in care of an individual

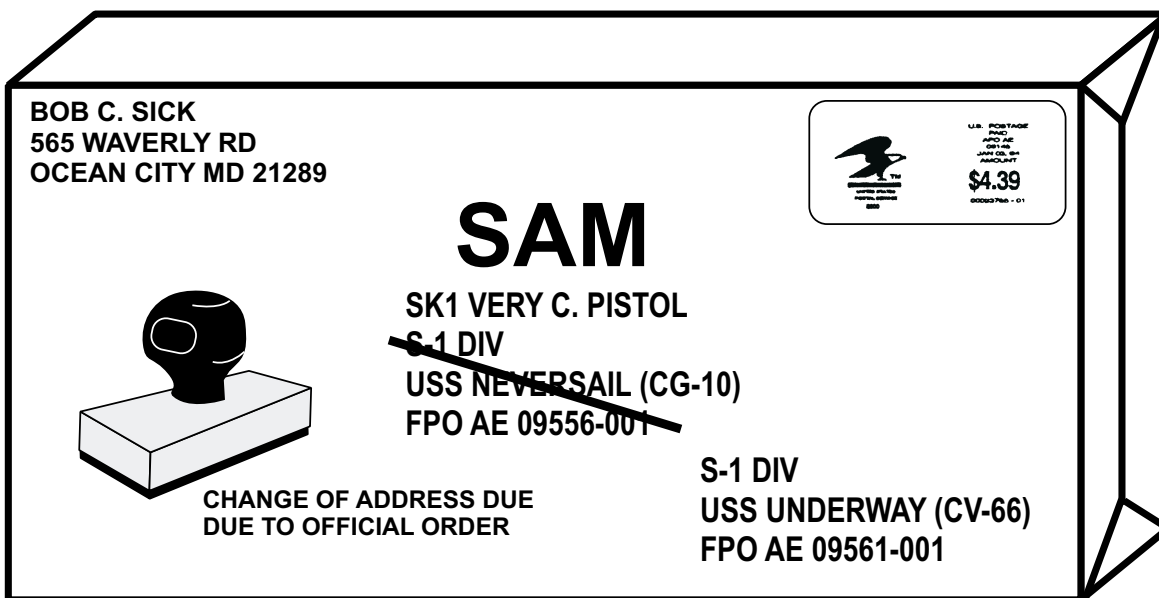

DISPOSITION: **FORWARD TO ADDRESSEE**

PC11116

Figure 11-16.—An example of a Standard Mail (B) piece, depicting endorsement when forwarded to the addressee.

**Table 11-4.—Treatment of Undeliverable-as-Addressed Standard Mail (B)**

RULE	ENDORSEMENT	MILITARY POSTAL DIRECTORY SERVICED SHALL:	MILITARY POSTAL DIRECTORY SERVICED BY THE USPS SHALL:
1	NO ENDORSEMENT	Forward. Endorse “Change of Address Due to Official Orders.” If a forwarding address is unknown, return to sender endorsed with the reason for nondelivery and Postage Due. Do not compute postage.	Forward. Endorse “Change of Address Due to Official Orders.” If a forwarding address is unknown, return to sender endorsed with the reason for nondelivery and Postage Due. Do not compute postage.
2	ADDRESS SERVICE REQUESTED	If forwarding address is known, prepare PS Form 3547 and send to mailer, then forward piece to addressee endorsed, “Change of Address Due to Official Orders.” If forwarding address is unknown, return to sender endorsed with the reason for nondelivery and Postage Due. Do not compute postage.	If forwarding address is known, prepare PS Form 3547 and send to mailer, then forward piece to addressee endorsed, “Change of Address Due to Official Orders.” If forwarding address is unknown, return to sender endorsed with the reason for nondelivery and Postage Due. Do not compute postage.
3	FORWARDING SERVICE REQUESTED	Forward. Endorse “Change of Address Due to Official Orders.” If forwarding address is unknown, return to sender endorsed with the reason for nondelivery and Postage Due. Do not compute postage.	Forward. Endorse “Change of Address Due to Official Orders.” If forwarding address is unknown, return to sender endorsed with the reason for nondelivery and Postage Due. Do not compute postage.
4	RETURN SERVICE REQUESTED	Return to sender with new address or reason for nondelivery attached and Postage Due. Do not compute postage.	Return to sender with new address or reason for nondelivery attached and Postage Due. Do not compute postage.
5	CHANGE SERVICE REQUESTED	<p>(Unit mailclerks and mail orderlies.) Endorse each piece of mail as “Undeliverable as Addressed,” and return to the serving MPO.</p> <p>(MPO) Prepare PS Form 3547 and send to mailer then piece disposed of.</p> <p>This endorsement is not available with special services.</p>	<p>Prepare PS Form 3547 and send to mailer. Endorse each piece as, “Undeliverable as Addressed.” Return to the servicing USPS facility.</p> <p>Piece disposed of by USPS.</p> <p>This endorsement is not available with special services.</p>

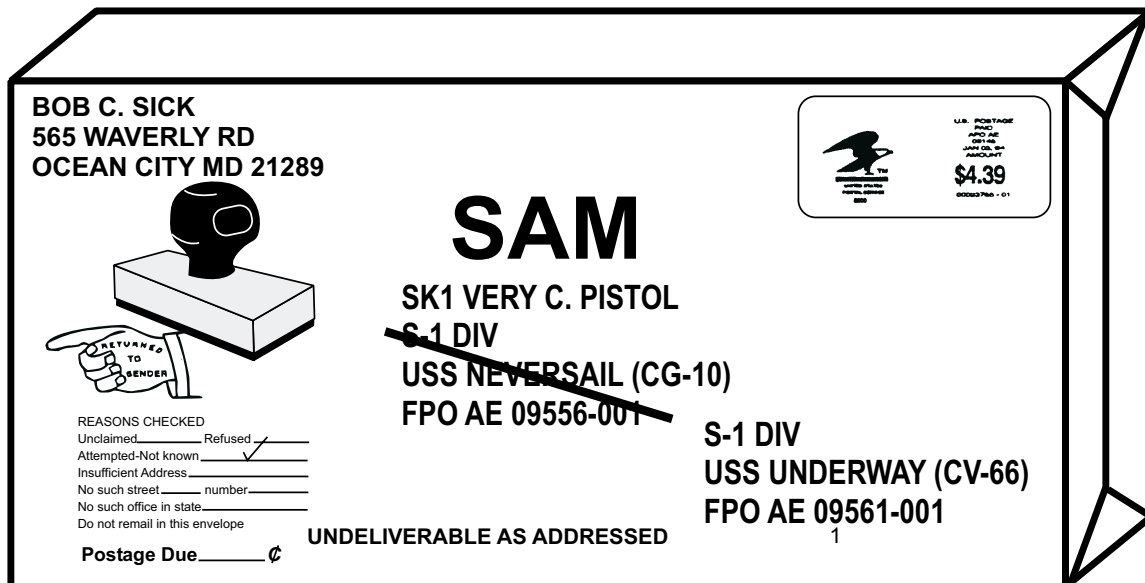

**DISPOSITION: RETURN TO SENDER** PC1117  
 Figure 11-17.—An example of a Standard Mail (B) piece depicting endorsement when returned to the sender.

who is authorized MPO privileges, you should notify the individual of the infraction.

**DIRECTORY MAIL RETURNED FROM UNIT MAILROOMS**

Mail that received directory service by unit mail clerks or mail orderlies should be returned to the serving postal activity separately from uncanceled outgoing mail. MPO personnel should screen the mail to make sure it is endorsed neatly and properly. If incorrect directory procedures are frequently noted after the unit mail clerk or mail orderly has been briefed on correct directory procedures, the postal officer should be advised.

**PERISHABLE ITEMS**

Perishable items that have a required delivery date (RDD) and cannot be forwarded or returned to the mailer before spoiling should be disposed of as waste. Do not forward these items to the serving Mail Recovery Branch. Also any perishable items obviously spoiled when received, whether deliverable or not, should be immediately disposed of as waste. You should always dispose of perishables in the presence of a witness and notify, in writing, the mailer and addressee of your action.

*Q11-10. Since each class of mail is handled differently, you must first identify each piece of directory mail for proper disposition. (True/False)*

- Q11-11. What PS form is used by a directory clerk to inform publishers of a change of address of a magazine?*
- Q11-12. What are the disposition instructions for an undeliverable catalog if your MPO is located overseas?*
- Q11-13. Which publication should you consult to find instructions concerning mail for personnel confined for disciplinary reasons?*
- Q11-14. What action is taken when mail addressed to personnel at overseas activities who are not authorized MPO privileges is received?*
- Q11-15. Perishable items that have a required delivery date (RDD) and cannot be forwarded or returned to the mailer before spoiling should be disposed of in what manner?*

Now turn to appendix I to check your answers.

**HOLD MAIL**

---

**Learning Objective:** *Identify the different types of, and the required handling for hold mail.*

---

Postal directories hold undeliverable as addressed mail when service members are due to arrive, absent without leave (AWOL), or when the mail is addressed to “general delivery.” General delivery mail is mail received at a post office intended primarily for delivery

to transients and customers who are not located permanently at an installation.

Each piece of hold mail must be backstamped to indicate the date of receipt. Mail being held is kept in a separate sortation case, sorted by last name, and screened at least weekly.

### **MEMBERS DUE TO ARRIVE**

Mail addressed for members due to arrive or for patrons receiving general delivery service must be handled as follows:

- Hold 15 days past the anticipated arrival date. For example, if the arrival date is 15 Oct 01, then hold the mail until 30 Oct 01. If the mail is unclaimed at that time, but the member is still expected to arrive because mail is still being forwarded, (the sender has the same last name as the addressee, or for similar reasons), then hold the mail for an additional 15 days or 30 days past the anticipated arrival date (see figure 11-18). For example, if you hold the mail until 30 Oct 01 and there are indications that the member is still expected to arrive, then hold the mail until 15 Nov 01.

**NOTE:** Mail addressed for general delivery must be provided priority directory service. Do not hold mail addressed for general delivery more than 30 days unless requested by the mailer or addressee.

- If the mail is still undeliverable at the end of the 30-day period, it will be endorsed “ATTEMPTED—NOT KNOWN” and returned to the sender if there is no further indication that the member is due to arrive on a later date. For correct endorsements when returning mail, see table 11-5.
- When the holding period expires, the date the mail is returned to the sender must be annotated on the directory service stamp, which is placed on the back of the mail (see figure 11-19).

### **MEMBERS ABSENT WITHOUT LEAVE (AWOL)**

The directory card for each member in an AWOL status must be annotated with the date the member went AWOL. This information is normally provided to the post office by the individual’s unit, or the base personnel office.

The postal directory section holds mail for individuals who are in an AWOL status for 30 days. The holding period begins the day after the individual goes AWOL. After being AWOL for 30 days, these individuals become deserters, and at that time, their mail is handled as follows:

- First-Class, and Priority Mail: First-Class and Priority Mail is returned to the sender endorsed “MOVED, LEFT NO ADDRESS” (see figure 11-20) with the return date annotated on the reverse side of the item.
- Periodicals: PS Form 3579 is completed, by marking the box labeled “MOVED, LEFT NO ADDRESS.” If publications are endorsed “Address Service Requested” then endorse them “MOVED, LEFT NO ADDRESS and POSTAGE DUE” and return the entire publication to the publisher with PS Form 3579 attached. Annotate the return date on the item. Do not indicate the amount of the postage due.
- Standard Mail (A) bearing the words ADDRESS SERVICE REQUESTED, RETURN SERVICE REQUESTED, or FORWARDING SERVICE REQUESTED; and Standard Mail (B): These items are returned to the sender endorsed “MOVED, LEFT NO ADDRESS and POSTAGE DUE” (see figure 11-21) with the date of return annotated on the reverse side of the item. Do not indicate the amount of the postage due.

### **REFUSED MAIL**

Occasionally letters and parcels are deliverable as addressed but the addressee refuses to accept them. If so, the post office will honor the patron’s request. But there are some conditions that apply when refusing mail. They are

- Accountable mail (e.g., Express, Registered, Insured, and Certified) must be refused by the patron at the time of delivery, before receipting for the article.
- Non-accountable mail may be refused at the time of delivery, or after delivery if it is returned to the post office unopened.
- Patrons must write, “REFUSED” on the front of the mail, the date the mail was refused, and sign their name (see figure 11-22). If the addressee

**Table 11-5.—Endorsements Used When Forwarding or Returning Mail**

<b>RULE</b>	<b>IF THE ADDRESSEE IS:</b>	<b>THEN ENDORSE MAIL:</b>	<b>AND:</b>
1	AWOL(over 30 days)	Moved Left No Address	Return to Sender
2	Unknown	Attempted - Not Known	Return to Sender
3	Reassigned	With current address	Forward to Addressee
4	TDY/TAD with parent unit (See Note)	With TDY/TAD location address	Forward to Addressee
5	TDY/TAD without parent unit (See Note)	With TDY/TAD location address	Forward to Addressee
6	Hospitalized (non-casualty)	With the hospital address (Include ward and room number if known)	Forward to addressee
7	Due to arrive	With date of receipt and date of arrival	Hold
8	Casualty	Proper endorsement	Forward after notification of next of kin (see DOD Postal Manual)
	<b>IF THE MAIL IS:</b>	<b>THEN ENDORSE MAIL:</b>	<b>AND:</b>
9	Missent	Missent to (include your unit/MPO number)	Forward to addressee
10	Opened by mistake	Opened by Mistake (if possible have the person who opened the mail sign their name next to the endorsement)	Forward to addressee
11	Balloting material	Proper endorsement	See DOD Postal Manual
12	Addressed illegibly	Illegible	Return to Sender
13	Addressed to a receptacle number not assigned to the MPO, and the correct MPO number is not known	No Such Number	Return to Sender
14	Fails to bear a receptacle number or unit designation, and the correct address is not known	Insufficient Address	Return to Sender
15	Refused by addressee	Refused or Refused by Addressee (if willing have addressee sign next to endorsement, if not clerk must sign)	Return to Sender
16	Abandoned General Delivery not called for in 30 days/Receptacle mail not called for (See DOD Postal Manual)	Unclaimed	Return to Sender
17	Undeliverable as addressed. Standard Mail bearing endorsement, Return Service Requested.	Undeliverable as Addressed and Postage Due	Return to Sender
18	Addressed to Commander of a receptacle number but does not contain the addressee's name or unit number	Insufficient Address	Return to Sender
NOTE: Rules 4 and 5 apply only when the addressee has requested forwarding service.			

Sender & Addressee same last name is an indication that the individual is expected to arrive.

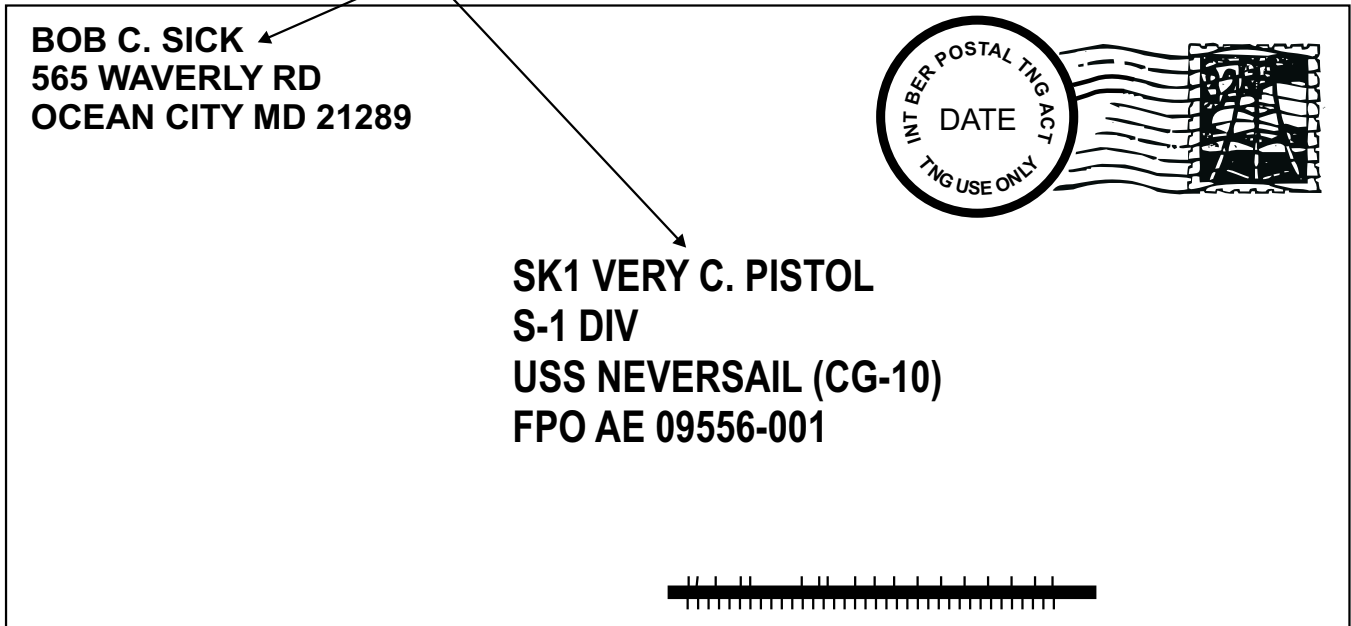

DISPOSITION: **HOLD 30 JUL 01**

AO1118

For classroom purposes only, write the disposition of the article. See page ii of the handout.

Figure 11-18.—An example of an article depicting hold mail date.

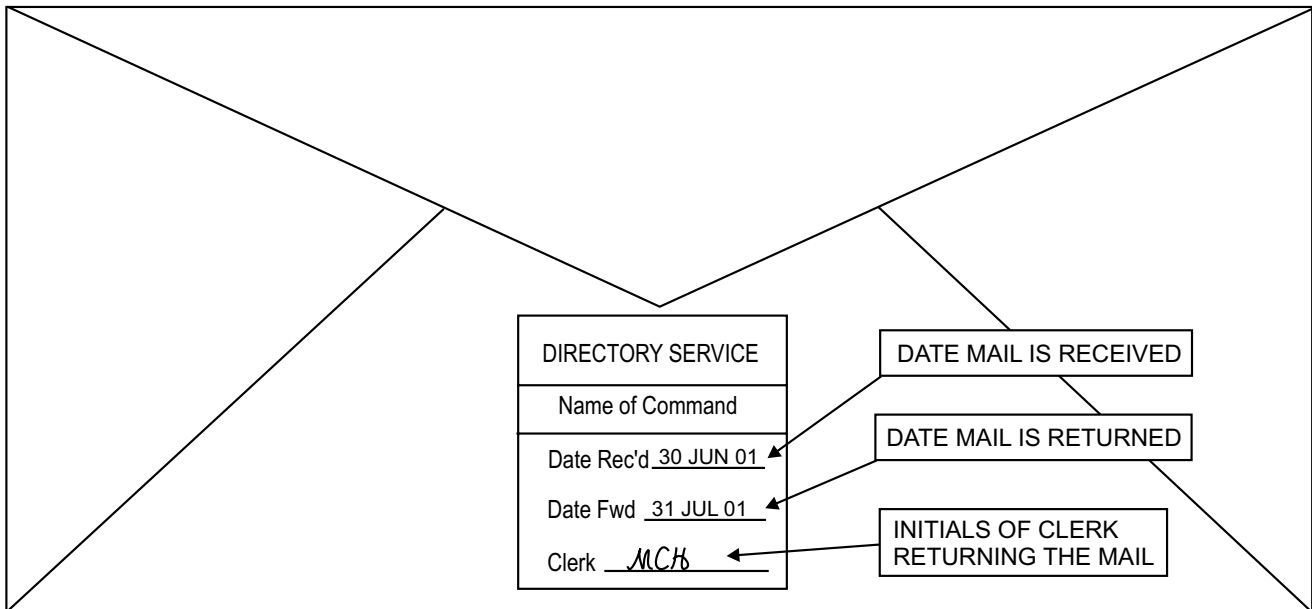

AO1119

Figure 11-19.—An example of an article depicting return date.



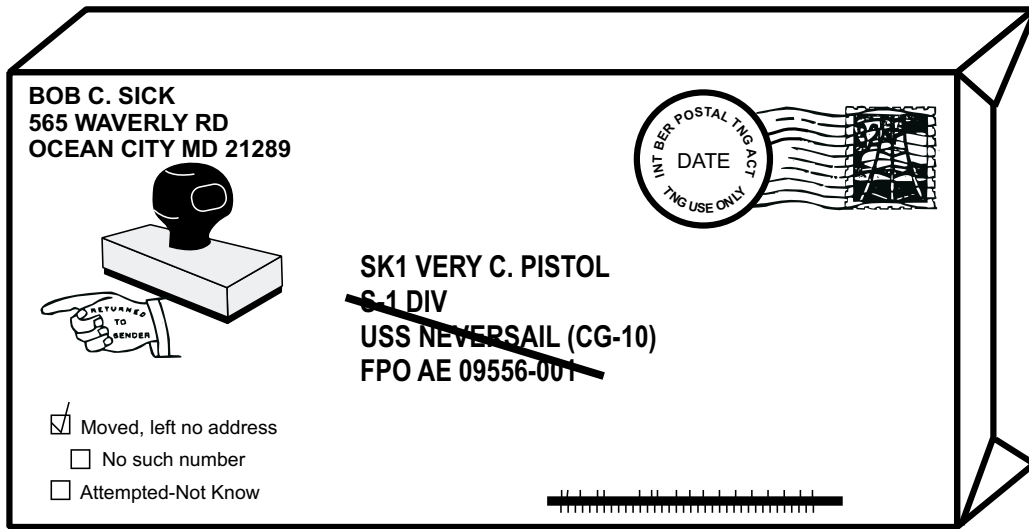

DISPOSITION: RETURN TO SENDER

For classroom purposes only, write the disposition of the article. See page ii of the handout.

Figure 11-20.—An example of an endorsement on First-Class, and Priority Mail articles being returned to the sender when individuals are AWOL Over 30 Days.

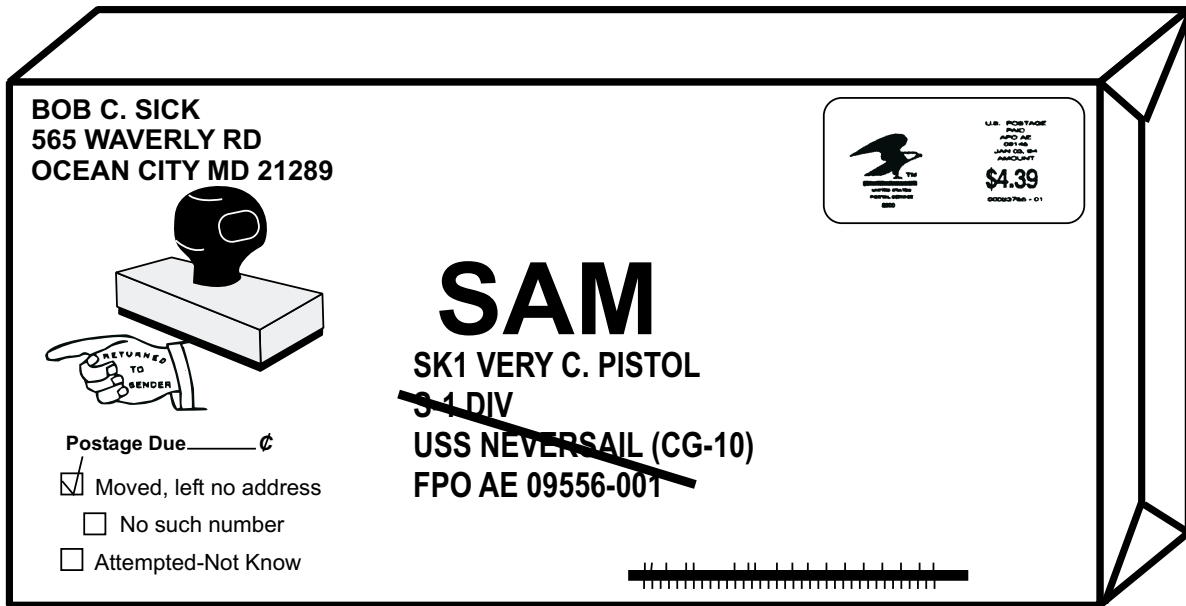

DISPOSITION: RETURN TO SENDER

Figure 11-21.—An example of an endorsement on Standard Mail articles being returned to the sender when individuals are AWOL over 30 days.

refuses to do this, then the postal clerk must endorse the mail “REFUSED BY ADDRESSEE” date and sign it. Then the mail is returned to the sender.

### INCORRECTLY ADDRESSED OR ILLEGIBLY ADDRESSED MAIL

Sometimes, while working at the directory section, you will receive mail that doesn’t have the correct

address, the address is not complete, or maybe the address is illegible (it can’t be read because the handwriting is bad or the address has faded out for different reasons). Every attempt should be made to deliver the mail to the addressee. Search the directory card files for the person’s name and address.

- If an address is found, write it on the item and deliver the item.

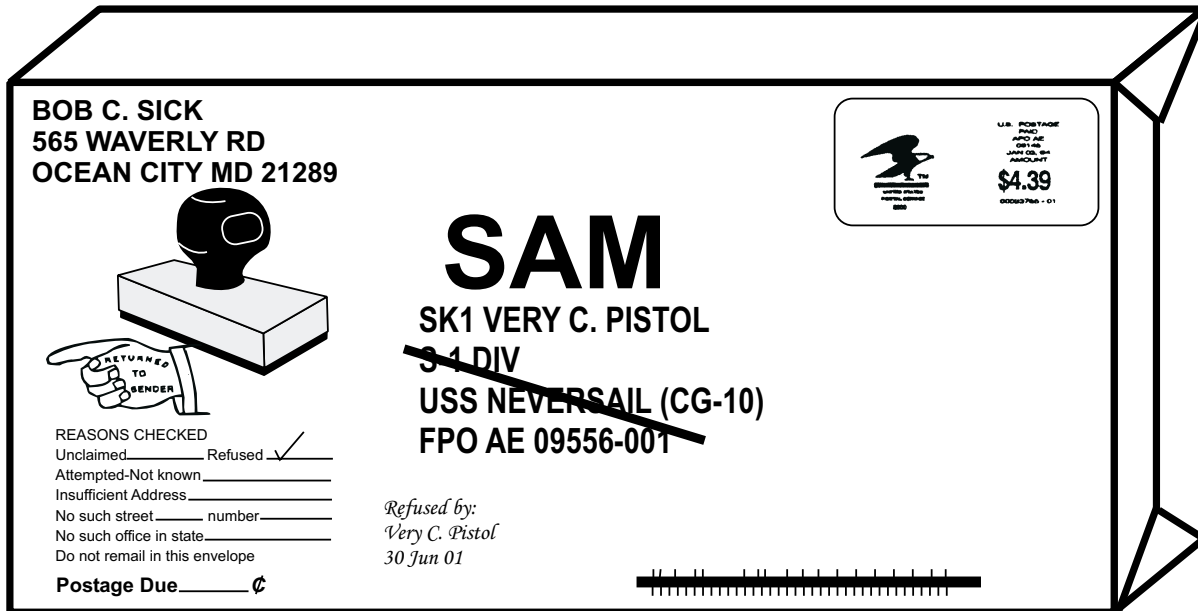

PCF1122

**DISPOSITION: RETURN TO SENDER**

Figure 11-22.—An example of an endorsement on mail being refused by addressee.

- If part of the address is missing, write the missing information on the item and deliver the item (see figure 11-23).
- If a name or address cannot be found, return the item to the sender endorsed “ATTEMPTED, NOT KNOWN.”
- If the address is unreadable, return the item to the sender endorsed “ILLEGIBLE.”

First-Class Mail received from a mailer in quantities of 20 or more, addressed insufficiently or wrong, or containing an obviously incorrect or identical receptacle number used simply to obtain directory service will be returned to the sender endorsed “INSUFFICIENT ADDRESS.” Mail received from mailers who continuously mail quantities of less than 20 letters simply to circumvent the procedure given above, will also be returned to the sender endorsed “INSUFFICIENT ADDRESS.”

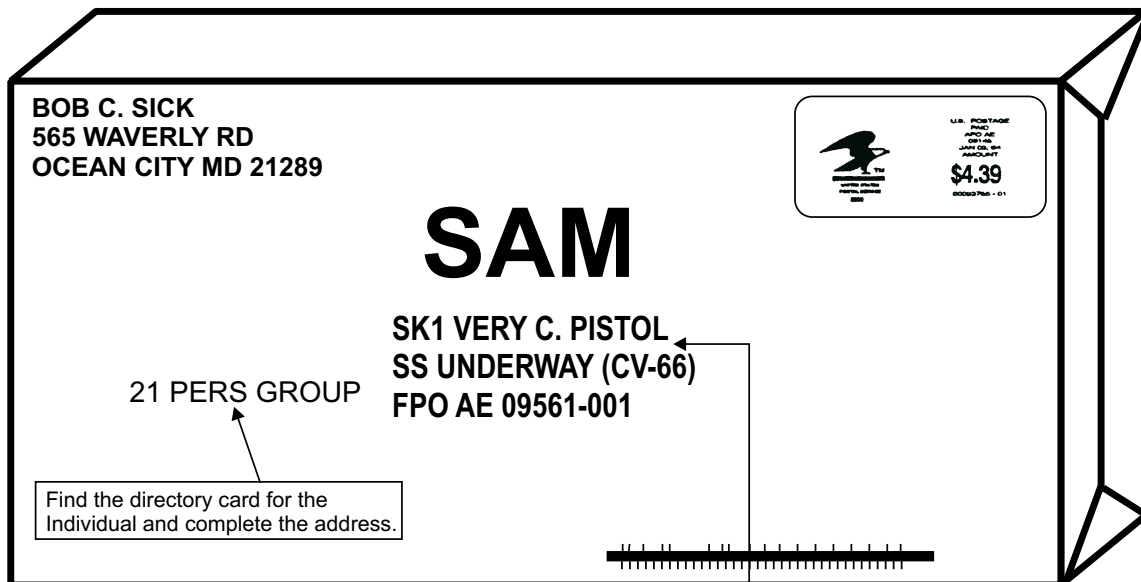

PCF1123

**DISPOSITION: DELIVER TO ADDRESSEE**

The address is missing the Individual's unit of assignment.

Figure 11-23.—An example of a piece of mail depicting a correction on incomplete address.

## CASUALTY MAIL

Casualty mail is unique to the MPS. It can be divided into two categories, wartime and peacetime. Wartime casualty mail is mail that cannot be delivered or forwarded for various reasons. Also included in the casualty mail status are Missing in Action (MIA), and Prisoner of War (POW).

Hold mail for personnel who are killed in action (KIA) until absolute verification that the next of kin have been notified is received. This verification comes from the Command Element. This mail may be held as long as necessary to prevent inadvertent disclosure of casualty status before official notification of next of kin. Once verification has been received, then the mail should be returned to the sender or forwarded to the next of kin, accompanied by a letter from the Commanding Officer (refer to chapter 5 of OPNAVINST 5112.6).

For peacetime purposes, casualty mail refers to personnel who have died by accident or have been killed; personnel who are missing, or have been hospitalized. When a person dies, the procedures are the same as in wartime. Mail will be held until verification of death is received. Then the mail can be forwarded or returned as needed. Mail for personnel that are hospitalized can be forwarded once their hospital address is known, or the mail can be held until the person returns to the command or unit.

Endorse casualty mail as follows:

- **DECEASED.** When the member has died and next of kin has been notified.
- **SEARCH.** When the member's status is unknown and the mail is being forwarded to the MPO or casualty mail section.
- **PATIENT.** When the member has been hospitalized and the hospital is known (also include the ward number and current hospital address).
- **HOSPITAL SEARCH.** When the member is evacuated through medical channels to an unknown hospital and mail is being forwarded to a casualty mail section.

Under no circumstances should the endorsements **MISSING, KILLED IN ACTION, or WOUNDED** be placed on casualty mail.

## DEAD MAIL

Dead mail is undeliverable matter that cannot be returned to the sender. Some reasons mail cannot be returned to the sender include:

- Sender is unknown.
- Classification of the mail does not entitle it to return service.

Process dead mail as follows:

- Endorse the article with the reason for non-delivery. If the addressee is unknown, then endorse it "ATTEMPTED, NOT KNOWN."
- Prepare a PS Label 22, Dead Mail Matter (see figure 11-24). When the volume of dead mail is more than one item, bundle the mail. Prepare a PS Label 22 and attach it to the top item only. Each dead parcel must have a PS Label 22 attached to it.

Send all dead mail, except unendorsed Standard Mail (A), to the respective Mail Recovery Center

Enter the respective MRC address base on your theater of operation.

US POSTAL SERVICE

First Class Mail  
Postage & Fees Paid  
USPS  
Permit No. G-10

FOR MAIL RECOVERY CENTER

At **ST PAUL MN 552001-9609**

DEAD MAIL MATTER

use this label for transmitting dead mail.

When the amount of mail to be sent is sufficient for pouching or sacking, fold this label and use as a pouch or sack label; otherwise use it as a package label.

POSTMARK OF MAILING OFFICE

INT BER POSTAL TNG ACT  
30 JUN 2001  
TNG USE ONLY

Label 22, December 1994

PCf1124

Postmark with the APDS.

Figure 11-24.—An example of a completed PS Label 22, Dead Mail Matter.

(MRC) for your area. Unendorsed Standard Mail (A) articles are disposed of as waste. The complete addresses for the MRCs can be found in chapter 6 of the POM (see table 11-6).

**MAIL FOR DECOMMISSIONED SHIPS AND DISESTABLISHED STATIONS**

The administrative commander for ships and mobile units and the CNO area coordinator or area commander for other disestablished or decommissioned activities will designate an activity to perform directory service for mail received for the decommissioned unit. Directory service will be performed by the designated command for a period of 60 days after decommissioning. During this time personal mail will be forwarded and official mail screened for necessary action or other appropriate disposition. Mail received after expiration of the 60-day period will be returned to the sender endorsed to show the activity was decommissioned.

There is an exception. After the expiration of the 60-day forwarding period, obvious value supply parcels addressed to decommissioned units should continue to be forwarded to the appropriate commander for disposition pending publication of the decommissioning. The command listings are deleted in serial changes to the SNDL. Obvious supply parcels received at the JMPAs subsequent to publication in the SNDL will be returned to the mailer endorsed to indicate that the unit has been decommissioned.

In no case may official mail addressed to a United States ship be forwarded unopened to the new title of that ship when it has been stricken from the Navy List and transferred to a foreign government or to the Merchant Marine service.

Personnel assigned as MPCs, mail orderlies, or to other positions where their duties involve the receipt and delivery of unopened mails normally are not assigned to duties involving opening and screening of official mail.

Commanding officers of ships and activities being decommissioned or placed in the reserve fleet must furnish the activity designated to provide directory service with a complete directory of officers and enlisted personnel. This directory must show the new duty station of each crewmember, or, in the case of personnel separated from the service, the forwarding address furnished by the individual. The designated activity should destroy this directory information upon completion of the 60-day forwarding period.

The command being disestablished should inform the appropriate mail-routing authority or postmaster of the date desired for routing of mail to the unit that will provide directory service for the decommissioned unit.

*Q11-16. List the three endorsements that should NEVER be placed on casualty mail.*

*Q11-17. Directory mail service for a decommissioned ship will be performed by a designated activity for what period of time?*

Now turn to appendix I to check your answers.

**Table 11-6.—Addresses for Mail Recovery Centers**

FPO AE addresses send dead mail to:	ST PAUL MAIL RECOVERY CENTER US POSTAL SERVICE 180 KELLOGG BLVD E ST PAUL MN 55101-9609
FPO AA addresses send dead mail to:	ATLANTA MAIL RECOVERY CENTER US POSTAL SERVICE 5345 FULTON INDUSTRIAL BLVD ATLANTA GA 30336-9590
FPO AP addresses send dead mail to:	SAN FRANCISCO MAIL RECOVERY CENTER US POSTAL SERVICE 390 MAIN ST SAN FRANCISCO CA 94105-9602
Do not send IDS articles to the addresses given above. Each theater of operation has a designated Dead Mail section where these articles are sent.	

## CHAPTER 12

# POSTAL EQUIPMENT AND SUPPLIES

At all MPOs, USPS equipment, publications, and supplies are to be used to the maximum extent possible. This includes capital and sensitive equipment, expendable supplies, and all required USPS publications.

Office equipment, such as safes, office furniture, copying machines, and calculators, are provided by the respective military service. The military services also provide pens, pencils, writing paper and other general office supplies needed to operate an MPO. Military post offices can also order General Services Administration (GSA) stock items approved by MPSA. Normally, only the Navy's largest post offices order supply items from GSA; smaller offices usually obtain needed items through the Navy's supply channels. For the information of postal clerks who may be tasked with ordering GSA items, table 12-1 provides an example of some MPSA approved GSA items that Navy post offices are authorized to order.

Navy post offices overseas in the Atlantic Theater order supplies from GSA via JMPA-A using PS Form 7380 or 7381, as appropriate for the type of item(s) being ordered.

Navy post offices overseas in the Pacific Theater can order GSA items direct from their serving GSA Customer Supply Center (CSC) located in Hawaii or Japan, using GSA Form 3542, GSA Customer Supply Center Order Form, (see figure 12-1). Before ordering supplies the COPE must establish an account by submitting GSA Form 3525, Application for Customer Supply Center Services and Address Change, to the address of the CSC serving their area (see figure 12-2). Postal clerks desiring additional information on ordering GSA items should contact MPSA or their serving JMPA.

DD forms and OPNAV forms required for office operation should be procured through local supply channels.

USPS forms required to be maintained in a Navy MPO are listed in the OPNAV 5112.6. When requisitioning USPS forms, labels, tags, and publications, refer to USPS Publication 223.

**Table 12-1. MPSA Approved Item List, GSA Stock, Nonstock, and Deleted Items**

**Military Postal Service Agency Approved Item List  
(GSA Stock Items)  
FY 2000**

	NSN	Item Name	Unit Of Issue
1	7530001450414	PAPER,TABULATING MA	BX (2500)
2	7530013380625	PAPER,TABULATING MA	BX (1300)
3	7530002910098	FOLDER,FILE	HD
4	7530001449601	PAPER,TABULATING MA	BX (950)
5	7530013543983	ENVELOPE,TRANSLUCEN	BX (500)
6	7530002900617	PAPER,BOND	BX (5000)
7	7510002433435	RUBBER BAND	BG (.250 LB)
8	7530000431194	FOLDER,FILE	HD
9	7510005308881	BINDER,LOOSE-LEAF	EA
10	7530002223521	BOOK,MEMORANDUM	EA
11	7520002633425	PERFORATOR,PAPER,DE	EA
12	7540006344018	OF 363	PG (20)
13	8345007533235	FLAG,NATIONAL	EA
14	5340009856735	CASTER,RIGID	EA
15	7530013542327	ENVELOPE,TRANSLUCEN	BX (500)
16	8345007533234	FLAG,NATIONAL	EA
17	7530013543982	ENVELOPE,TRANSLUCEN	BX (500)
18	7520002815911	BASKET,WASTEPAPER	EA
19	7510002816180	BINDER,LOOSE-LEAF	EA
20	7530001608477	INDEX SHEET SET,LOO	SE
21	7920001711148	MOPHEAD,WET	EA
22	5110001616912	SHEARS,STRAIGHT TRI	EA
23	7520002326828	TRAY,DESK	EA
24	8105011740943	BAG,PLASTIC	BX (500)
25	8135005986097	TAPE,GUMMED	RO (450 FT)
26	7520002247589	PERFORATOR,PAPER,DE	EA
27	7530002900599	PAPER,BOND	BX (5000)
28	7530002868363	BOOK,MEMORANDUM	EA
29	7510005842491	PORTFOLIO	BX (25)
30	7520002402411	DISPENSER,PRESSURE	EA
31	7530009886515	CARD,GUIDE,FILE	HD
32	7540012316227	SF 2809	HD
33	7530002866178	PAPER,MIMEOGRAPH	BX (5000)
34	7520002866959	CASE,FILING,TRANSFE	EA
35	5340009856736	CASTER,SWIVEL	EA
36	7340004887939	KNIFE,PARING	EA
37	7510002814309	BINDER,LOOSE-LEAF	BX (25)
38	7530002223455	TAPE,PAPER,COMPUTIN	RO (200 FT)
39	7920009265244	BUCKET,MOP	EA
40	7520005437149	PEN,BALL-POINT	DZ
41	8345007533230	FLAG,NATIONAL	EA
42	7540006344036	SF 86	HD
43	7540012314280	SF 2817	HD
44	7530002444035	PAPER,CARBON,TYPEWR	HD
45	7510002433434	RUBBER BAND	BG (.250 LB)
46	7530002815945	FOLDER SET,FILE	HD

PC1201A

Table 12-1. MPSA Approved Item List, GSA Stock, Nonstock, and Deleted Items Continued

Military Postal Service Agency Approved Item List  
(GSA Stock Items)  
FY 2000

	NSN	Item Name	Unit Of Issue
47	7920009265245	BUCKET,MOP	EA
48	6645005303342	CLOCK,WALL	EA
49	5110009529109	KNIFE,TWINE,FINGER	DZ
50	7510005519821	TAPE,PRESSURE SENSI	RO (36 YD)
51	7530010719769	PAPER,CARBON,PENCIL	HD
52	7510013900723	FINGER PAD,RUBBER	DZ
53	7920001616219	SPONGE	DZ
54	4020007825574	TWINE,FIBROUS	CE (5LB)
55	7520002815932	BOX,FILING	EA
56	7920009265243	BUCKET,MOP	EA
57	7510002433437	RUBBER BAND	BG (.250 LB)
58	8135002922354	TAG,SHIPPING	MX
59	9905005592971	SIGN	EA
60	7510013900728	FINGER PAD,RUBBER	DZ
61	7510002723044	HOLDER,BINDER LABEL	PG (12)
62	7920006826862	WRINGER,MOP	EA
63	5340009856734	CASTER,RIGID	EA
64	7240002406958	SAFETY CAN	EA
65	5340009856737	CASTER,SWIVEL	EA
66	7530009123925	TAPE,POSTAGE METER	PG (6)
67	5110005958411	KNIFE,TWINE,FINGER	DZ
68	7920006826861	WRINGER,MOP	EA
69	7510013900722	FINGER PAD,RUBBER	DZ
70	8520002700065	SOAP,BORAX	BX (5 LB)
71	9905007823768	HOLDER,CARD-LABEL	BG (50)
72	7530002866207	BOOK,RECORD	EA
73	7510002051439	RUBBER BAND	BG (.250 LB)
74	7510001616211	CUP,SPONGE	BX (12)
75	7540006344250	SF 2801	PG (25)
76	7540006344037	SF 87	HD
77	7510007826275	ENVELOPE,TRANSPAREN	PG (25)
78	7510013900727	FINGER PAD,RUBBER	DZ
79	7510002815972	HOLDER,BINDER LABEL	PG (12)
80	7520002405498	ARCH BOARD FILE	EA
81	7920007823779	CLOTH,CLEANING	HD
82	7920002929204	CLOTH,CLEANING	MX
83	8135002711446	TAPE,GUMMED	RO (600 FT)
84	5110007713732	CUTTER,STEEL STRAPP	EA
85	8135007823948	CHIPBOARD	BX (634)
86	8455008989730	BADGE,IDENTIFICATIO	HD
87	7510006044150	MOISTENING COMPOUND	EA
88	7540006344340	SF 1152	HD
89	7530005774376	LABEL	PG (248)
90	7530002444073	PAPER,CARBON,TYPEWR	HD
91	7520002866957	CASE,FILING,TRANSFE	EA
92	7540006344041	SF 91	HD

PC11201B

Table 12-1. MPSA Approved Item List, GSA Stock, Nonstock, and Deleted Items Continued

Military Postal Service Agency Approved Item List  
(GSA Stock Items)  
FY 2000

	NSN	Item Name	Unit Of Issue
93	7540012469252	SF 3102	HD
94	7520002866958	CASE,FILING,TRANSFE	EA
95	7530004016910	PAPER SET,MANIFOLD	BX (500)
96	5110009529110	KNIFE,TWINE,FINGER	DZ
97	7530002613813	CARD SET,GUIDE,FILE	SE
98	7540012316228	SF 2823	HD
99	7520001626156	STAND,CALENDAR PAD	EA
100	7520002412981	MOISTENER	EA
101	7510013900721	FINGER PAD,RUBBER	DZ
102	7530007846143	TAPE,PAPER,COMPUTIN	RO (112 FT)
103	7530007823996	PAPER,CARBON,PENCIL	HD
104	7530007823994	PAPER,CARBON,PENCIL	HD
105	7520002718884	RUBBER STAMP,BAND T	EA
106	7920006339274	PAD,WAX APPLICATOR	EA
107	7510009954852	PORTFOLIO	EA
108	7540012495576	SF 3106	HD
109	7510002050371	RUBBER BAND	BG ( 250 LB)
110	7540006343972	SF 15	HD
111	7540012315585	SF 2818	PG (25)
112	7510000579305	INK,STAMP PAD	BT (8 OZ)
113	7540012321234	SF 2810	HD
114	7540006344046	SF 95	HD
115	7540006344083	SF 127	HD
116	7910006853910	PAD,FLOOR POLISHING	BX (10)
117	7510005261741	INKING PAD,RUBBER S	EA
118	7530002613819	CARD SET,GUIDE,FILE	HD
119	7510013900726	FINGER PAD,RUBBER	DZ
120	7510001614240	INK,STAMP PAD	BT (2OZ)
121	7530005774368	LABEL	PG (248)
122	8135002708726	TAPE,GUMMED	RO (800 FT)
123	7540006344045	SF 94	HD
124	7530010722538	PAPER SET,MANIFOLD	BX (500)
125	7540006344356	SF 1164	HD
126	7530005774371	LABEL	PG (248)
127	7540012315587	SF 2821	HD
128	7510005261742	INKING PAD,RUBBER S	EA
129	7530002388352	TAPE,PAPER,COMPUTIN	RO (200 FT)
130	7530009123924	TAPE,POSTAGE METER	PG (6)
131	7910006856671	PAD,FLOOR POLISHING	BX (10)
132	7520001626153	STAND,CALENDAR PAD	EA
133	8415008574915	HELMET,SAFETY	EA
134	7530005774369	LABEL	PG (248)
135	8125007824000	BOTTLE,APPLICATOR	EA
136	6210009302818	NIGHT LIGHT	EA
137	7530007823961	LABEL	PD (100)
138	7510001478477	TAB SET,INDEX	BX (5)

PC11201C

Table 12-1. MPSA Approved Item List, GSA Stock, Nonstock, and Deleted Items Continued

Military Postal Service Agency Approved Item List  
(GSA Stock Items)  
FY 2000

	NSN	Item Name	Unit Of Issue
139	7540013336239	SF 52	HD
140	7240002406957	SAFETY CAN	EA
141	7540006344260	SF 2808	HD
142	8105007824002	BAG,TEXTILE	EA
143	7540006343964	SF 8	HD
144	7910006853914	PAD,FLOOR POLISHING	BX (10)
145	7540000822447	OF 27	HD
146	4020002826411	TWINE,FIBROUS	BA (1450 FT)
147	7540006344249	SF 2800	HD
148	7530009594562	PAD,WRITING PAPER	PD (50)
149	4510002032709	DISPENSER,SOAP	EA
150	7540009268972	SF 98	PG (50)
151	7540012315586	SF 2819	HD
152	7510013900725	FINGER PAD,RUBBER	DZ
153	7510013900720	FINGER PAD,RUBBER	DZ
154	7540006344252	SF 2803	HD
155	5110009529111	KNIFE,TWINE,FINGER	DZ
156	7510013900719	FINGER PAD,RUBBER	DZ
157	7520002575006	STAPLE REMOVER,OFFI	EA
158	7540001181008	SF 98-A	PG (50)
159	7530002237958	PAD,COLUMNAR	PD (50)
160	7530002613804	CARD SET,GUIDE,FILE	HD
161	8135002903408	PAPER,KRAFT,UNTREAT	BD (850)
162	7510001478475	TAB SET,INDEX	BX (5)
163	7910006856659	PAD,FLOOR POLISHING	BX (10)
164	7510001478488	TAB SET,INDEX	BX (5)
165	7520006341573	RUBBER STAMP,BAND T	EA
166	7510001478487	TAB SET,INDEX	BX (5)
167	7520001627117	NUMBERING MACHINE,O	EA
168	7540006343999	OF 346	HD
169	7910006856687	PAD,FLOOR POLISHING	BX (10)
170	7520001627109	NUMBERING MACHINE,O	EA
171	7510013900724	FINGER PAD,RUBBER	DZ
172	7540007534941	OF 16	HD
173	7540012315588	SF 2822	HD
174	7540001594836	SF 122	PG (50)
175	4020007825572	TWINE,FIBROUS	BA (1960 FT)
176	7540006344338	SF 1150	HD
177	7540006826750	SF 75	HD
178	7540006344264	OF 7	HD
179	7540006344253	SF 2804	HD
180	7540009009859	SF 126	HD
181	7910006856657	PAD,FLOOR POLISHING	BX (10)
182	7540006344341	SF 1153	HD
183	7540006344093	SF 135	HD
184	7540006344254	SF 2805	HD

PC1201D

When requisitioning USPS equipment and certain supply items, refer to USPS Publication 247. Equipment and supply items should be ordered on an as-needed basis

Table 12-1. MPSA Approved Item List, GSA Stock, Nonstock, and Deleted Items Continued

Military Postal Service Agency Approved Item List  
(GSA Stock Items)  
FY 2000

	NSN	Item Name	Unit Of Issue
185	8020006641375	BRUSH,ARTIST'S	EA
186	7540006344287	SF 1098	HD
187	7540004735482	OF 15	HD
188	7540012314279	SF 2811	HD
189	7540008237952	SF 135-A	HD
190	7540012495577	SF 3106A	HD
191	7540006344230	SF 1080	HD
192	7540006344111	SF 210	HD
193	7540006344049	SF 99	HD
194	7540006344030	SF 81	HD

PC1201E

and are limited to those items that are not required to be furnished by the Navy. If USPS capital and sensitive equipment is needed, your serving FLTCINC and JMPA must first approve their procurement.

**USPS CAPITAL AND SENSITIVE EQUIPMENT**

**Learning Objective:** Recall the procedures for receipting, requisitioning, and performing maintenance on USPS capital and sensitive equipment.

Capital equipment is equipment such as conveyors with a service life over 1-year, costing \$3,000 or more; sensitive equipment is equipment that must be strictly controlled because of the nature of the equipment. Money order imprinters, MODIS equipment, scales, postage meter heads and bases are some examples of sensitive equipment.

The commanding officer or postal officer, as appropriate, should ensure that the COPE is the only individual entrusted with the custody, control, maintenance, repair, replacement, or disposition of USPS capital and sensitive equipment.

The COPE receipts for all capital and sensitive (accountable equipment) on PS Form 1590, Supplies and Equipment Receipt (see figure 12-3) when assuming responsibility of an MPO. Each time





**Table 12-1. MPSA Approved Item List, GSA Stock, Nonstock, and Deleted Items Continued**

**Military Postal Service Agency Approved Item List  
(Deleted GSA Items)  
FY 1999**

NSN	Item Name	STATUS
7540011786724	SF 2824C	GSA Management Deleted
7540012495574	SF 3105	GSA Management Deleted
7540001308501	FORM, PRINTED	GSA Management Deleted

PC1201G

additional equipment is received, transferred, or otherwise disposed of a new PS Form 1590 must be completed. In addition to submitting a new PS Form 1590 when there is a change of COPE, a complete inventory of all entrusted accountable items must be done by both the outgoing COPE and incoming COPE.

After completion, submit PS Form 1590s to the NPFO in San Diego, CA, for verification. Once PS Form 1590 has been verified, the NPFO will sign, date, and return a copy to the COPE. Upon receipt of the signed copy, it must be retained in the MPO files.

**REQUISITIONING CAPITAL AND SENSITIVE EQUIPMENT**

When you requisition capital and sensitive equipment items, make sure the Requisition For Supplies, Services, or Equipment, PS Form 7381, is filled out accurately and completely (see figure 12-4). A separate PS Form 7381 must be used for each item requested; however, more than one of the same item can be requested on the same form. Requisitions must be forwarded to the responsible FLTCINC for approval. Requisitions are then submitted by the FLTCINC to the serving JMPA for final processing. Justification for equipment must be listed in Section 12 (Rationale) of PS Form 7381. If there is not enough space in Section 12 to enter all the necessary information, a letter of justification should be attached to the requisition. Examples of justification include renovation of a post office or replacing existing equipment that is beyond repair.

**MAINTENANCE OF EQUIPMENT**

As mentioned above the COPE is primarily responsible for the upkeep of all USPS equipment assigned to the MPO. However, junior PC's could be

tasked with performing the cleaning and maintenance on this equipment and should be constantly aware of its condition. USPS equipment needing repair or maintenance must be serviced to avoid further damage.

When USPS equipment can no longer be repaired economically and restored to a safe and serviceable condition, replacement equipment should be requisitioned. Accountable items must be disposed of following instructions in the NPFO handbook for returning accountable equipment.

When performing maintenance on USPS equipment, use the manufacturer's handbook, if available, to ensure the minimum preventive measures required to keep USPS equipment operational are met. All MPO supervisors are responsible for making sure maintenance is performed. With the exception of meter heads, money order imprinters, and MODIS and IRT equipment, local repair of equipment is authorized. When repairs cannot be made locally, coordination must be made with the serving JMPA to repair equipment such as meter bases, and scales. Money order imprinters and MODIS equipment must always be sent to the serving JMPA for repair. Postage meter heads must always be sent to the meter vendor. UNYSIS III Integrated Retail Terminals must be sent to Larell IRT-CAC, 3655 Tampa Road, Oldsmar, FL, 34677-6307 by Express Mail, or registered mail if Express Mail service is not available. Whenever USPS accountable equipment is returned for repair (except for UNYSIS III IRT), PS Form 1590 and PS Form 4805, Maintenance Work Order Request (see figure 12-5) must accompany the equipment. When sending the UNYSIS III IRT for repair, only PS Form 4805 must be completed and sent with the IRT. When mailing the IRT, an e-mail or naval message must be sent to the serving JMPA listing the serial number of the IRT, description of problem(s), the Express Mail or registered mail number under which the IRT was sent,

# GSA Customer Supply Center Order Form

please make copies of this original, both front and back, for reference and placing orders • please print clearly

customer name \_\_\_\_\_

ship to address \_\_\_\_\_

method of payment:  credit card      GSA internal billing:  SIBAC    check

credit card number \_\_\_\_\_

expiration date \_\_\_\_\_

document number (optional) \_\_\_\_\_

date \_\_\_\_\_

telephone number \_\_\_\_\_

fax number \_\_\_\_\_

signature of approving/ordering official (optional) \_\_\_\_\_

activity address code \_\_\_\_\_

access code \_\_\_\_\_

remarks \_\_\_\_\_

if an item is out of stock, would you like it backordered?  yes  no

if an item is not carried, would you like it special ordered?  yes  no

item number (last 9 digits of NSN)	item description	u/i	quantity	unit price	extended price
1					
2					
3					
4					
5					
6					
7					
8					
9					
10					
11					
12					
If your order exceeds 12 items, please send multiple pages				est. total cost	

Mailable items may be shipped by small package carrier or USPS to your APO address within 4 - 7 days of order placement.

**for gsa use only**

Store	Ticket Number	Lines	Total	Call Back (Date, Time, Initials)

**Figure 12-1. An example of a GSA Customer Supply Center Order Form.**

<b>APPLICATION FOR CUSTOMER SUPPLY CENTER SERVICES AND ADDRESS CHANGE</b>										
<b>IMPORTANT:</b> Read instructions on reverse carefully, before completing this form.										
SECTION I - APPLICATION										
1. ACTIVITY ADDRESS CODE (6 digits)			2. BILLED OFFICE CODE (6 digits)			NOTE: Maximum of 35 characters per block for Agency Name, Office Name, Contact Name, Street Address, and City. Punctuation and spaces count as characters.				
3. SHIP TO: (Catalogs sent to this address)					4. BILL TO: (Complete only if different from item 3.)					
a. AGENCY NAME					a. CONTACT NAME					
b. OFFICE NAME					b. AGENCY NAME					
c. STREET ADDRESS					c. OFFICE NAME					
d. CITY					d. STREET ADDRESS					
e. STATE			f. ZIP CODE		e. CITY			f. STATE	g. ZIP CODE	
LINE NO.	5. ACCESS CODE (3 to 5 digits)	6. NAME, OFFICE, ETC., PRINTED ON SHIPPING LABEL (Optional) (Maximum 28 characters. Punctuation and spaces count as characters.)				7. FUND CODE (2 digits)	8. AGENCY INTERNAL CODE (6 digits)			
1										
2										
3										
4										
5										
6										
7										
8										
9										
9. COST ELEMENT* (3 digits)			10. FUNCTION CODE* (3 digits)		11. VDC* (2 digits)	12. PURCHASE CARD USAGE ONLY <input type="checkbox"/> CHECK HERE IF APPLICABLE		13. TYPE OF APPLICATION <input type="checkbox"/> NEW <input type="checkbox"/> ADDRESS CHANGE		
14a. SIGNATURE OF APPROVING OFFICER							14d. TELEPHONE AREA CODE   NUMBER			
14b. TYPED NAME OF APPROVING OFFICER				14c. TITLE OF APPROVING OFFICER			14e. DATE			
SECTION II - ACTION (For GSA use only)										
The eligibility of the above-named activity to patronize the GSA Customer Supply Center has been checked and the application approved or disapproved, as indicated in Item 20a. below.										
15. AGENCY BUREAU CODE (4 digits)			16. STATE CODE (2 digits)		17. CITY CODE (4 digits)		18. CONTRACTOR		19. EXPIRATION DATE (6 digits)	
20a. ACTION <input type="checkbox"/> APPROVED <input type="checkbox"/> DISAPPROVED			21. TYPE OF CUSTOMER AGENCY <input type="checkbox"/> CIVILIAN AGENCY <input type="checkbox"/> CONGRESSIONAL (If Contractor/Congressional, give expiration date) ▼ <input type="checkbox"/> MILITARY <input type="checkbox"/> CONTRACTOR				22a. SIGNATURE OF GSA APPROVING OFFICIAL			
20b. DATES RECEIVED   APP./DISAPP.							22b. TYPED NAME OF GSA APPROVING OFFICIAL			
<input type="checkbox"/> ADDRESS LOADED			DATE		CLERK INITIALS		<input type="checkbox"/> CATALOG AND CUSTOMER APPLICATION COPY MAILED		DATE	
GENERAL SERVICES ADMINISTRATION					*(GSA ONLY)			GSA FORM 3525 (REV. 8-95) Prescribed by FSS P2901.14		

PCF12002

**Figure 12-2. An example of an Application For Customer Supply Center Services And Address Change.**

and date sent.

*Q12-1. Who provides MPOs with the necessary supplies, publications, and equipment to operate?*

*Q12-2. What agency provides MPOs with equipment such as safes, calculators, office furniture, and copying machines?*

*Q12-3. What agency(ies) provide(s) MPOs with common supply items such as pens, and writing paper?*

U.S. Postal Service		Date		
<b>Supplies and Equipment Receipt</b>		02 FEB 2001		
FROM: Post Office, State and ZIP+4 PFO, 4070 SURFACE NAVY BLVD, STE 3 SAN DIEGO, CA 92136-5287		Section of Unit		
Requested By (Individual or Title) COPE, USS UNDERWAY (CV-66)		Consignment Completed By	Work Order/Route Sheet Number	
TO: ● CUSTODIAN OF POSTAL EFFECTS ● USS UNDERWAY (CV-66) FPO AE 09561-0001  Approved: _____ Foreman, MPE Date		Shipment Made By Hand to Hand		
		<b>Distribution</b> 1. Original to stockroom file. 2. Duplicate to mechanic. 3. Triplicate to personnel folder.		
		<b>Custody Receipt</b> This form may be used as an intra-office custody receipt.		
Quantity	Item Number	Property Code Number	Description	Recorded Cost
1	0-854	A4119.01	SCALE, 100 LB BEAM, S/N 5296	
2	8100		MONEY ORDER IMPRINTER S/N 6N65446/6N65447	
1	07407	A4654.07	POSTAGE METER HEAD S/N 472983	
1	07408	A4654.09	POSTAGE METER BASE S/N 87205	
*****NO FURTHER ENTRIES*****				
Loan Period (Number of Days)	Date Loaned 02 FEB 2001	Date Returned	Received in good condition? <input checked="" type="checkbox"/> Yes <input type="checkbox"/> No If NO, explain on reverse.	Final salary or expense checks will not be released until all property for which an employee is individually responsible has been returned or satisfactorily accounted for.
			Received By (Signature) <i>John R. Doe</i> PC1 JOHN R. DOE	

PS Form 1590, May 1991

PC112003

Figure 12-3. An example of a completed PS Form 1590.

Q12-4. On what PS form should you list all accountable USPS equipment?

Now turn to appendix 1 to check your answers.

### USPS NONCAPITAL AND NONSENSITIVE EQUIPMENT AND EXPENDABLE SUPPLIES

**Learning Objective:** Recognize USPS non-capital, and non-sensitive (non-accountable) equipment and expendable supplies, and the procedures for ordering.

The USPS furnishes nonaccountable items. When nonaccountable equipment is received at MPOs, it becomes the property of the Department of Defense

(DOD). Nonaccountable items need not be receipted for formally. However, to maintain property accountability, all nonaccountable items received at MPOs should be entered in supply records as appropriate.

### USPS EXPENDABLE ITEMS

MPOs with more than one clerk assigned will designate an individual as the postal supply clerk in addition to carrying out regular duties. The supply clerk's specific duties include receiving and issuing supplies, care and preservation of supplies, and the disposal and replacement of obsolete forms and supplies. Additional responsibilities include the monitoring of the stock levels of postal supplies to prevent overstocking and the requisitioning of items necessary to maintain postal operations. MPOs should normally maintain at least a 3-month level, but not more than a 5-month level of USPS expendable supplies on board.



## Requisition for Supplies, Services, or Equipment

1. Date	2. Request No.	3. Budget Finance No.	4. Account No.	5. Property Accountability Finance No.	6. Property Code No.	7. Capital Property ID No.	
8. Job Order Number (Maintenance Use Only)			WC	Acronym	Equipment No.	EC	Work Order No.
<b>REQUESTOR INFORMATION</b>				<b>DELIVERY INFORMATION</b>			
9a. Name		Title		10a. Contact		Telephone No. ( )	
9b. Signature		9c. Organization		10b. Address			
9d. Address				City		State	ZIP + 4
City		State	ZIP + 4	10c. Desired Delivery Date		10d. Required Delivery Date	
9e. Telephone No. ( )		9f. FEDSTRIP Address Code		10e. FEDSTRIP Address Code		10f. Acceptable Delivery Times From: To:	
<b>SUPPLIES, SERVICES, OR EQUIPMENT INFORMATION</b>							
11a. Item/Part No.	11b. Supplies, Services, or Equipment Requested <i>(Attach SOW, specifications, or other technical data, if applicable)</i>			11c. Unit of Issue	11d. Quantity	Estimated	
						11e. Unit Price	11f. Total Cost
12. Rationale					11g. Total Estimated Cost		\$
<b>SUGGESTED SOURCES OF SUPPLY (Provide name, street address, city, state, ZIP + 4, contact name, and telephone and fax no.)</b>							
13a.			13b.			13c.	
<b>APPROVALS (The contracting official is authorized to make the purchase provided it does not exceed the amount entered below.)</b>							
14a. Certification of Funds (Signature, name, and title)						Date	
Funded Amount: \$							
14b. Approval Authority (Signature)				(Name and title)		Date	
14c. Other Approval (Signature)				(Name and title)		Date	
15. After Approval/Funding, Send to:				16. Local Notes			
<b>PURCHASING USE ONLY</b>							
17a. Excess Equipment Available? <input type="checkbox"/> No <input type="checkbox"/> Yes		17b. Buyer Initials	17c. Processing Code	17d. Assigned By/Date		17e. Control No.	17f. Date Due

PS Form 7381, November 1994

PCF12004

**Figure 12-4. An example of a PS Form 7381.**

### ISSUING SUPPLIES

Issuing supplies is the responsibility of the designated postal supply clerk. When issuing supplies, enough should be issued to each section of the MPO to last at least a week at a time. When supplies are issued

the balance on hand on PS Form 1586, Supply Record (see figure 12-6) must be adjusted to reflect the current balance. You accomplish this by subtracting the quantity issued from the quantity shown on the "Balance on Hand" column.

U.S. Postal Service  
**Maintenance Work Order Request**

**Work Request (To be completed by the requesting office or organization)**

Sub-site	Register Number	Work Order Number	Prior-ity	Work Code	Equipment Acronym	Equipment Number	Eqpt. Class	Date (MM-DD-YYYY)	issued Crew No.	Est. Time

Office Name  
 City  
 State  
 ZIP + 4

Floor Area Room  
 Person to Contact  
 Phone (include area code)

Requested By (Name and title)  
 Originating Department  
 Phone (include area code)  
 Date Required

Description of Work Requested (Equipment name and number if known)

---

Approved By (Name, title, and signature)  
 Date

**Work Order (To be completed by Maintenance)**

Description of Work Performed

---

Work Completed By	Date	Work Accepted By (Close Work Order)	Date

**Parts Issue (Use this section to record parts issues when MARS is unavailable for use.)**

Part Number	Nomenclature	Quantity	Issued By	Issued To

**Official Disposition (Use this section to verify work completion and closing of the Maintenance Work Order.)**

Maintenance Official Approval (Signature and title)  
 Date  
 Close Work Order (Maint. Ops. Support initials)

PS Form 4805, June 1998

Figure 12-5. An example of a PS Form 4805.

**DETERMINING WHAT TO REQUISITION**

When do I order supplies? This is a question that you may be asking yourself this moment. Order

supplies when the amount of supplies reaches, or falls below the minimum level required to be maintained on hand. Supply requisitions can be submitted at any time, but are normally prepared on a monthly or



PS Form 7380 in duplicate. Submit the original to the Material Distribution Center, Topeka, KS, and retain the duplicate copy in the post office files.

Requisitions are numbered consecutively beginning with number 1 on 1 October each year.

Requisitions must be reviewed and signed by the MPO supervisor or the COPE. Complete PS Form 7380 as follows (see figure 12-8):

Block 1: Type MPO supervisor or COPE along with the complete mailing address of your MPO.

United States Postal Service		MDC Supply Requisition			
Print or type complete mailing address of office preparing requisition COPE USS UNDERWAY (CV-66) ① FPO AE 09561-0001			For MDC use only ②		
Finance Number ③ 35-5835	FEDSTRIP Address Code ④ 18EA45	Julian Date ⑤ 1036	Requisition No. ⑥ 2-01	Page No. ⑦ 1 OF 1	
⑧ Postal Stock Number (PSN) or Postal Service Item Number (PSIN)	Quantity ⑨	Unit Issue ⑩	Description ⑪	Unit Price ⑫	Estimated Cost ⑬
PS 3806	350	SE	RECEIPT FOR REGISTERED MAIL		
PS 7380	100	SE	MDC SUPPLY REQUISITION		
5					Fold First
10					
15					
<b>Grand Total Amount of Order \$</b>					⑭
Send originals only					
Mail to: ⑮  SUPPLY REQUISITIONS MATERIAL DISTRIBUTION CENTER 500 SW MONTARA PKY TOPEKA KS 66624-9702			Authorizations		
			Name of Materiel Accountability Officer or Designate ⑯ JOHN R. DOE, PC1		
			Signature and Date ⑰ <i>John R. Doe</i> 5 Feb 2001		
			Name of Authority Certifying Funds ⑱		
			Signature and Date ⑲		
			PEN or Commercial Telephone Number w/ Area Code ⑳		

Figure 12-8. An example of a completed PS Form 7380.



Block 2: Leave blank.

Block 3: Enter your MPO finance number here. MPO ZIP Codes starting with 09XXX and 34XXX are assigned finance number 35-5825. MPO ZIP Codes starting with 96XXX are assigned finance number 05-6786.

Block 4: Enter your MPO FEDSTRIP address code. The FEDSTRIP address is a six-character code that identifies each postal activity to which goods and

billings are sent. Each Navy post office has a FEDSTRIP address code unique to their activity.

Block 5: Enter the Julian Date. The Julian Date is a 4-digit number that represents a specific date. The first digit represents the last number of the year; i.e., 1 of 2001. The next 3 numbers are a sequential number that represents a specific day of the year starting with 001 for 1 January through 365 for 31 December or 366 for 31 December on leap year (see tables 12-2 and 12-3).

Table 12-2. An example of a Julian date calendar

JULIAN DATE CALENDAR (PERPETUAL)													
Day	Jan	Feb	Mar	Apr	May	Jun	Jul	Aug	Sep	Oct	Nov	Dec	Day
1	001	032	060	091	121	152	182	213	244	274	305	335	1
2	002	033	061	092	122	153	183	214	245	275	306	336	2
3	003	034	062	093	123	154	184	215	246	276	307	337	3
4	004	035	063	094	124	155	185	216	247	277	308	338	4
5	005	036	064	095	125	156	186	217	248	278	309	339	5
6	006	037	065	096	126	157	187	218	249	279	310	340	6
7	007	038	066	097	127	158	188	219	250	280	311	341	7
8	008	039	067	098	128	159	189	220	251	281	312	342	8
9	009	040	068	099	129	160	190	221	252	282	313	343	9
10	010	041	069	100	130	161	191	222	253	283	314	344	10
11	011	042	070	101	131	162	192	223	254	284	315	345	11
12	012	043	071	102	132	163	193	224	255	285	316	346	12
13	013	044	072	103	133	164	194	225	256	286	317	347	13
14	014	045	073	104	134	165	195	226	257	287	318	348	14
15	015	046	074	105	135	166	196	227	258	288	319	349	15
16	016	047	075	106	136	167	197	228	259	289	320	350	16
17	017	048	076	107	137	168	198	229	260	290	321	351	17
18	018	049	077	108	138	169	199	230	261	291	322	352	18
19	019	050	078	109	139	170	200	231	262	292	323	353	19
20	020	051	079	110	140	171	201	232	263	293	324	354	20
21	021	052	080	111	141	172	202	233	264	294	325	355	21
22	022	053	081	112	142	173	203	234	265	295	326	356	22
23	023	054	082	113	143	174	204	235	266	296	327	357	23
24	024	055	083	114	144	175	205	236	267	297	328	358	24
25	025	056	084	115	145	176	206	237	268	298	329	359	25
26	026	057	085	116	146	177	207	238	269	299	330	360	26
27	027	058	086	117	147	178	208	239	270	300	331	361	27
28	028	059	087	118	148	179	209	240	271	301	332	362	28
29	029		088	119	149	180	210	241	272	302	333	363	29
30	030		089	120	150	181	211	242	273	303	334	364	30
31	031		090		151		212	243		304		365	31

Pct12002

Table 12-3. An example of a Julian date calendar for leap year

## JULIAN DATE CALENDAR FOR LEAP YEARS ONLY

Day	Jan	Feb	Mar	Apr	May	Jun	Jul	Aug	Sep	Oct	Nov	Dec	Day
1	001	032	061	092	122	153	183	214	245	275	306	336	1
2	002	033	062	093	123	154	184	215	246	276	307	337	2
3	003	034	063	094	124	155	185	216	247	277	308	338	3
4	004	035	064	095	125	156	186	217	248	278	309	339	4
5	005	036	065	096	126	157	187	218	249	279	310	340	5
6	006	037	066	097	127	158	188	219	250	280	311	341	6
7	007	038	067	098	128	159	189	220	251	281	312	342	7
8	008	039	068	099	129	160	190	221	252	282	313	343	8
9	009	040	069	100	130	161	191	222	253	283	314	344	9
10	010	041	070	101	131	162	192	223	254	284	315	345	10
11	011	042	071	102	132	163	193	224	255	285	316	346	11
12	012	043	072	103	133	164	194	225	256	286	317	347	12
13	013	044	073	104	134	165	195	226	257	287	318	348	13
14	014	045	074	105	135	166	196	227	258	288	319	349	14
15	015	046	075	106	136	167	197	228	259	289	320	350	15
16	016	047	076	107	137	168	198	229	260	290	321	351	16
17	017	048	077	108	138	169	199	230	261	291	322	352	17
18	018	049	078	109	139	170	200	231	262	292	323	353	18
19	019	050	079	110	140	171	201	232	263	293	324	354	19
20	020	051	080	111	141	172	202	232	264	294	325	355	20
21	021	052	081	112	142	173	203	234	265	295	326	356	21
22	022	053	082	113	143	174	204	235	266	296	327	357	22
23	023	054	083	114	144	175	205	236	267	297	328	358	23
24	024	055	084	115	145	176	206	237	268	298	329	359	24
25	025	056	085	116	146	177	207	238	269	299	330	360	25
26	026	057	086	117	147	178	208	239	270	300	331	361	26
27	027	058	087	118	148	179	209	240	271	301	332	362	27
28	028	059	088	119	149	180	210	241	272	302	333	363	28
29	029	060	089	120	150	181	211	242	273	303	334	364	29
30	030		090	121	151	182	212	243	274	304	335	365	30
31	031		091		152		213	244		305		366	31

PC112003

Block 6: Enter the requisition number. Number your requisitions consecutively beginning with number 1 on 1 October followed by the Fiscal Year (FY) for example, 1-01, 2-01, etc.

Block 7: Enter the requisition page number 1 of 1 in this section. If more than one page is used, then enter 1 of 2, 2 of 2, etc.

Block 8: Enter the group of forms or items in numerical order.

Block 9: Enter the quantity requested. (Ensure that this quantity is the same as the quantity you entered on PS Form 1586 under the ORDER block.)

Block 10: Enter the Unit of Issue; i.e., BK (Book), EA (Each), PD (Pad), etc.

Block 11: Enter a brief description of the item (name of form or item).

Blocks 12-14: Leave Blank.

Block 15: Mailing address of the MDC is preprinted in this block.

Block 16: Enter the name of the COPE or MPO Supervisor, followed by their grade and title.

Block 17: Signature of the COPE or MPO Supervisor and date signed.

Blocks 18-20: Leave Blank.

### **Touch Tone Order Entry System (TTOES)**

The purpose of TTOES is to speed up order processing, provide immediate feedback on rejected items, and to reduce keypunch errors. TTOES is an excellent way to order new supply items or to replenish an item that is in short supply.

All new users are required to register before using the system. Once registered you will receive a 10-digit access code (your area code and phone number). To place an order you call the 1-800 number provided by the USPS, and enter your 10-digit access code. Then the MDC will verify that the access code corresponds to your activity FEDSTRIP number. Once in the system, just follow the instructions provided (see figure 12-9).

When placing an order, have the 13-digit National Stock Number (NSN) from USPS Publication 223 or 247, or the quick pick number provided in the Postal Bulletin ready for the item(s) you are ordering.

### **PS Formx DDD, Express Mail, Priority Mail and Global Priority Mail Order Form**

Use PS Formx DDD to order Express Mail, Priority mail, and Global Priority mail supply items ONLY (see figure 12-10). Only those items listed on the form can be requisitioned. Prepare PS Formx DDD in duplicate. Submit the original to the Express and Priority Mail Supply Center, USPS, PO Box 95001, Indianapolis, IN 46295-0001, and retain the duplicate in the post office files. These products may also be ordered via the internet at the USPS web site. When placing your first order, you will fill out an application on line, which will establish your account. After the account is established you only have to enter your user name and password when ordering Express Mail, Priority mail, and Global Priority mail products.

MPOs must submit their requisitions on a monthly basis after they have been reviewed by the MPO supervisor or the COPE. Complete PS Formx DDD as follows:

Block 1: QUANTITY. Check the appropriate block for the amount needed. If the amount needed is not listed under the "Minimum" column, then check "Other" and write the amount.

Block 2: REPEAT ORDERS. Check "Monthly" for each item ordered.

Block 3: SHIP THIS ORDER TO. Enter your MPO mailing address.

### **EMERGENCY REQUISITION**

Emergency requisitions may be submitted when required by electrical message to MDC, Topeka, KS TWX 9102-749-6556. These requisitions must be limited to ordering items for which there is an urgent need. The emergency requisition message should be in the same format as PS Form 7380, and it should include the MPO FEDSTRIP code, finance number, and statement of justification. Before you submit an emergency requisition, you should attempt to obtain needed items from local sources.

The emergency requisition message should only be used by shorebased overseas activities or mobile units on deployment. Shipboard post offices in CONUS homeport should use TTOES when ordering supplies instead of a message.

*Q12-5. MPOs should maintain a minimum of how many months' level of USPS supply items?*

*Q12-6. What function does PS Form 1586 serve?*

*Q12-7. Who is responsible for maintaining PS Form 1586?*

*Q12-8. PS Form 7380 will be numbered in what manner?*

*Q12-9. What two items are required to use TTOES for ordering supplies?*

*Q12-10. What PS form is used to order Express and Priority Mail supplies?*

*Q12-11. Emergency requisitions should be submitted in what format?*

Now turn to appendix 1 to check your answers.



### TOUCH TONE ORDER ENTRY

The advantages of using the Touch Tone Order Entry System include:

- Faster order processing.
- Immediate feedback on ordered items.
- Improved order accuracy.

### TOLL FREE ORDER LINES

To place an order, Dial 1-800-332-0317, press option 1, then option 2. System is unavailable between 4:00 a.m. and 6:00 a.m. Central Time due to maintenance.

Item status such as cost and availability may be obtained 24 hours a day by accessing the automated system at 1-800-332-0317, option 3.

#### PROCESSING TIMES

Orders placed before 4:45 p.m. Central Time will be processed that evening for release to the warehouse the next business day.

#### HOW TO REGISTER

Only NEW users must register to use the system. To register, call 1-800-332-0317, option 8, extension 2925. Follow the instructions to leave a message. (Wait 48 hours before placing your first order.)

#### HOW TO ACCESS THE SYSTEM

1. If you have registered previously, call 1-800-332-0317, press **1**, and then press **2** to place an order.
2. Enter the 10-digit Access Code chosen when registering to use the system (usually your office phone number).
3. The System will tell you your FEDSTRIP number. (If the FEDSTRIP number the system gives you is not your FEDSTRIP number, do not continue with your order. Press **2** to re-enter your Access Code to try again, or press **0** for assistance.)

Press

- 1** if correct.
- 2** to re-enter Access Code.
- 0** to transfer to Materials Customer Service for assistance.
- #** to end the call.

#### TO PLACE AN ORDER

Press **1** to order by 13-digit NSN.

Enter **13-digit NSN** (check PUB223 or PUB247 for the correct NSN).

After the prompt,

Enter Quantity, then press the \* key.

The System will repeat the **Item Number** ordered.

The System will repeat the **Quantity** ordered.

The System will tell you the **Unit of Issue** ordered.

Press

- 1** if correct (places order for item).
- 2** to re-enter order.

Or press **#** to return to Main Menu.

Press **2** to order by 3-digit Quick Pick Number.

Enter **3-digit Quick Pick Number**.

After the prompt,

enter Quantity, then press the \* key.

The System will repeat the **Item number** ordered.

The System will repeat the **Quantity** ordered.

The System will tell you the **Unit of Issue** ordered.

Press

- 1** if correct (places order).
- 2** to re-enter order.

Or press **#** to return to Main Menu.

#### ONLY MAINTENANCE-CAPABLE OFFICES WILL BE GIVEN THE OPPORTUNITY TO USE THIS OPTION — ORDERS ARE PROCESSED HOURLY.

Press **3** to order emergency vending machine parts.

Enter the vending part **13-digit NSN**.

After the prompt,

Enter Quantity, then press the \* key.

The System will repeat the **Item number** ordered.

The System will repeat the **Quantity** ordered.

The System will tell you the **Unit of Issue** ordered.

Press

- 1** if correct (places order for item).
- 2** to re-enter order.

Or press **#** to return to Main Menu.

Press **1** for Express Mail; Press **2** for Priority Mail.

Press **#** to return to Main Menu.

Press **4** to order keys for Mail Equipment Shop (MES) locks.

Enter the **4- or 5-digit lock #**, then press the \* key.

Enter up to a 6-digit box #, then press the \* key.

If no box #, then press the \* key.

Enter up to a 2-digit Quantity, then press the \* key.

After the prompt,

The System will repeat the **lock #** ordered.

The System will repeat the **box #** if one was given.

The System will repeat the **Quantity** ordered.

Press

- 1** if correct (places order for item).
- 2** to re-enter order.

Or press **#** to return to Main Menu.

**CONTACT MES @ 202-281-2620 WITH ANY DISCREPANCIES OR IF ORDER IS NOT RECEIVED IN THREE WEEKS.**

#### TO EXIT THE SYSTEM

Press **#** to return to the Main Menu, then **#** from the Main Menu to end the call.

If your order was accepted, you will be given a 9-digit order number consisting of the last four digits of the FEDSTRIP along with four digits of the Julian date and ending with an "S." You will also be given the total number of items ordered and total approximate cost. In addition, you will be given a chance to transfer to a customer service representative.

**IF YOU HANG UP WITHOUT EXITING PROPERLY, YOUR ORDER WILL BE PLACED; HOWEVER, YOU WILL NOT RECEIVE YOUR ORDER NUMBER.**



MATERIAL DISTRIBUTION CENTER  
500 SW MONTARA PKWY  
TOPEKA KS 66624-9998

#### How To Get Help

For help or problems with the ordering system, call 1-800-332-0317, option **4**.  
Materials Customer Service hours of operation are M-F, 6 a.m.-6 p.m., Central Time.

PCf12009

Figure 12-9. An example of the TTOES ordering instructions.

# Express Mail, Priority Mail and Global Priority Mail Order Form

Telephone Orders: 1-800-610-8734 FAX Orders: 1-800-270-6233

Listed below are all Express, Priority, and Global Priority Mail envelopes, boxes, tubes and identifying labels. A minimum order quantity for each item has been established. Please determine your needs either at the minimum level number noted or multiples of that number. Check the appropriate block for the amount needed or write the amount in the other block. You may order on an as needed basis or on a repeat order basis. If you choose to repeat your order, indicate the cycle by checking the block under the column marked "Repeat Orders." You may change your repeat order at any time by calling the above 800 number, faxing or mailing your changes.

The bottom part of the form must be completed to ensure that your order is shipped correctly.

①

②

Supply Type	Supply Item Description	PSN / Item Number	Quantity		Repeat Orders	
			Minimum	Other	Monthly	Quarterly
Express Mail	Window Envelope for Custom Design Express Mail Label.....	EP 13	<input type="checkbox"/> 1	<input type="checkbox"/> Other	<input type="checkbox"/>	<input type="checkbox"/>
	8 oz. Standard Envelope—Cardboard.....	EP 13A	<input type="checkbox"/> 1	<input checked="" type="checkbox"/> Other <u>25</u>	<input checked="" type="checkbox"/>	<input type="checkbox"/>
	Customer Receipt Envelope.....	EP 13B	<input type="checkbox"/> 25	<input type="checkbox"/> Other	<input type="checkbox"/>	<input type="checkbox"/>
	Tyvek Envelope— Large.....	EP 13C	<input type="checkbox"/> 1	<input type="checkbox"/> Other	<input type="checkbox"/>	<input type="checkbox"/>
	International Envelope.....	EP 13E	<input type="checkbox"/> 10	<input type="checkbox"/> Other	<input type="checkbox"/>	<input type="checkbox"/>
	Flat Rate Envelope — Cardboard.....	EP 13F	<input type="checkbox"/> 1	<input type="checkbox"/> Other	<input type="checkbox"/>	<input type="checkbox"/>
	Box 12 1/4 x 15 1/2 x 3.....	0-1093	<input type="checkbox"/> 25	<input type="checkbox"/> Other	<input type="checkbox"/>	<input type="checkbox"/>
	Tube 6 x 38 Express or Priority.....	0-1098	<input type="checkbox"/> 20	<input type="checkbox"/> Other	<input type="checkbox"/>	<input type="checkbox"/>
	Next Day Post Office to Post Office Label.....	Label 11A	<input type="checkbox"/> 1	<input type="checkbox"/> Other	<input type="checkbox"/>	<input type="checkbox"/>
	Next Day Post Office to Addressee Label.....	Label 11B	<input type="checkbox"/> 1	<input checked="" type="checkbox"/> Other <u>100</u>	<input checked="" type="checkbox"/>	<input type="checkbox"/>
	Custom Designed Label.....*	Form 5625	<input type="checkbox"/> 1	<input type="checkbox"/> Other	<input type="checkbox"/>	<input type="checkbox"/>
	Next Day Post Office to Post Office Label (continuous form labels).....*	Label 11E	<input type="checkbox"/> 10	<input type="checkbox"/> Other	<input type="checkbox"/>	<input type="checkbox"/>
	Next Day Post Office to Addressee Label (continuous form labels).....*	Label 11F	<input type="checkbox"/> 10	<input type="checkbox"/> Other	<input type="checkbox"/>	<input type="checkbox"/>
	Custom Designed Label (continuous form labels).....*	Label 5625C	<input type="checkbox"/> 10	<input type="checkbox"/> Other	<input type="checkbox"/>	<input type="checkbox"/>
	Drop Shipment Tag.....	TAG 157	<input type="checkbox"/> 1	<input type="checkbox"/> Other	<input type="checkbox"/>	<input type="checkbox"/>
	EMCA Postage / Fees Paid Adhesive Label.....	Label 108	<input type="checkbox"/> 1 pad	<input type="checkbox"/> Other	<input type="checkbox"/>	<input type="checkbox"/>
	Tape.....	Label 119	<input type="checkbox"/> 1 roll	<input type="checkbox"/> Other	<input type="checkbox"/>	<input type="checkbox"/>
	Outside Pressure Sensitive Label.....	Label 83	<input type="checkbox"/> 1	<input type="checkbox"/> Other	<input type="checkbox"/>	<input type="checkbox"/>
	Pickup Form.....*	Form 5541	<input type="checkbox"/> 1	<input type="checkbox"/> Other	<input type="checkbox"/>	<input type="checkbox"/>
	Pickup Form (continuous).....	Form 5541C	<input type="checkbox"/> 10	<input type="checkbox"/> Other	<input type="checkbox"/>	<input type="checkbox"/>
Priority Mail	Flat Rate Envelope — Cardboard 6 x 10.....	EP 14B	<input type="checkbox"/> 1	<input type="checkbox"/> Other	<input type="checkbox"/>	<input type="checkbox"/>
	Tyvek Envelope — 12 x 15 1/2.....	EP 14	<input type="checkbox"/> 1	<input type="checkbox"/> Other	<input type="checkbox"/>	<input type="checkbox"/>
	Flat Rate Envelope — Cardboard 12 1/2 x 9 1/2.....	EP 14F	<input type="checkbox"/> 1	<input type="checkbox"/> Other	<input type="checkbox"/>	<input type="checkbox"/>
	Envelope — Cardboard 5 x 10 (Window).....	EP 14H	<input type="checkbox"/> 1	<input type="checkbox"/> Other	<input type="checkbox"/>	<input type="checkbox"/>
	Box 7 x 7 x 6 (Box 04).....	0-10100-04	<input type="checkbox"/> 25	<input type="checkbox"/> Other	<input type="checkbox"/>	<input type="checkbox"/>
	Box 12 x 12 x 8 (Box 07).....	0-10101-07	<input type="checkbox"/> 25	<input type="checkbox"/> Other	<input type="checkbox"/>	<input type="checkbox"/>
	Box 12 1/4 x 15 1/2 x 3.....	0-1095	<input type="checkbox"/> 25	<input type="checkbox"/> Other	<input type="checkbox"/>	<input type="checkbox"/>
	Box "Video" 9 1/4 x 6 1/4 x 2..... (Large)	0-1096 Large	<input type="checkbox"/> 25	<input type="checkbox"/> Other	<input type="checkbox"/>	<input type="checkbox"/>
	Box "Video" 8 5/8 x 5 5/8 x 15/16..... (Small)	0-1096 Small	<input type="checkbox"/> 25	<input type="checkbox"/> Other	<input type="checkbox"/>	<input type="checkbox"/>
	Box 11 1/4 x 14 x 2 1/4.....	0-1097	<input type="checkbox"/> 25	<input type="checkbox"/> Other	<input type="checkbox"/>	<input type="checkbox"/>
	Tube 6 x 38 Express or Priority.....	0-1098	<input type="checkbox"/> 20	<input type="checkbox"/> Other	<input type="checkbox"/>	<input type="checkbox"/>
	Sticker (Pressure Sensitive Strip).....	Label 106	<input type="checkbox"/> 1	<input checked="" type="checkbox"/> Other <u>250</u>	<input checked="" type="checkbox"/>	<input type="checkbox"/>
	Tape.....	Label 106A	<input type="checkbox"/> 1 roll	<input type="checkbox"/> Other	<input type="checkbox"/>	<input type="checkbox"/>
	Sticker (Pressure Sensitive 50/pad).....	Label 107	<input type="checkbox"/> 1 pad	<input type="checkbox"/> Other	<input type="checkbox"/>	<input type="checkbox"/>
	Sticker (Pressure Sensitive 400/roll).....	Label 107R	<input type="checkbox"/> 1 roll	<input type="checkbox"/> Other	<input type="checkbox"/>	<input type="checkbox"/>
Address Label.....	Label 228	<input type="checkbox"/> 1	<input type="checkbox"/> Other	<input type="checkbox"/>	<input type="checkbox"/>	
Address Label (continuous form labels).....*	Label 228C	<input type="checkbox"/> 10	<input type="checkbox"/> Other	<input type="checkbox"/>	<input type="checkbox"/>	
Drop Shipment Tag.....	TAG 159	<input type="checkbox"/> 1	<input type="checkbox"/> Other	<input type="checkbox"/>	<input type="checkbox"/>	
Global Delivery Service	International Express Mail Service Guide.....	PUB 273	<input type="checkbox"/> 1	<input type="checkbox"/> Other	<input type="checkbox"/>	<input type="checkbox"/>
	Global Priority Flat Rate Envelope - Cardboard (12 1/2 x 9 1/2).....	EP 15A	<input type="checkbox"/> 1	<input type="checkbox"/> Other	<input type="checkbox"/>	<input type="checkbox"/>
	Global Priority Flat Rate Envelope - Cardboard (6 x 10).....	EP 15B	<input type="checkbox"/> 1	<input type="checkbox"/> Other	<input type="checkbox"/>	<input type="checkbox"/>
	Global Priority Mail Sticker.....	DEC 10	<input type="checkbox"/> 1	<input type="checkbox"/> Other	<input type="checkbox"/>	<input type="checkbox"/>
	Global Priority Mail Box 12 5/16 x 9 1/4 x 2 (Four lb. limit).....	0-1099	<input type="checkbox"/> 25	<input type="checkbox"/> Other	<input type="checkbox"/>	<input type="checkbox"/>
	Global Priority Mail Tyvek Envelope 12 x 15 1/2.....	EP 15GP	<input type="checkbox"/> 1	<input type="checkbox"/> Other	<input type="checkbox"/>	<input type="checkbox"/>
Other Supplies	Postal Customer Order Form.....	Formx DDD	<input type="checkbox"/> 1	<input checked="" type="checkbox"/> Other <u>2</u>	<input checked="" type="checkbox"/>	<input type="checkbox"/>
	Customs.....	Form 2976	<input type="checkbox"/> 1	<input type="checkbox"/> Other	<input type="checkbox"/>	<input type="checkbox"/>
	Customs Declaration and Dispatch Note.....	Form 2976A	<input type="checkbox"/> 1	<input type="checkbox"/> Other	<input type="checkbox"/>	<input type="checkbox"/>
	Envelope for PS Form 2976A.....	Form 2976E	<input type="checkbox"/> 1	<input type="checkbox"/> Other	<input type="checkbox"/>	<input type="checkbox"/>
	Delivery Confirmation Form (Retail).....	Form 152	<input type="checkbox"/> 1	<input type="checkbox"/> Other	<input type="checkbox"/>	<input type="checkbox"/>
	* These forms may be overprinted / customized by calling 1-800-610-8734	Form 3800	<input type="checkbox"/> 1	<input type="checkbox"/> Other	<input type="checkbox"/>	<input type="checkbox"/>
		Form 3811	<input type="checkbox"/> 1	<input type="checkbox"/> Other	<input type="checkbox"/>	<input type="checkbox"/>

Ship This Order To:

Customer Number: | | | | | | | | | |

Attention: COPE | | | | | | | | | |

Phone: | | | | | | | | | |

Company Name: | | | | | | | | | |

Address: ③ U.S. UNDERWAY CV-66 | | | | | | | | | |

City, State, ZIP+4: FPO AE 09561-0001 | | | | | | | | | |

PS Formx DDD April 2000PS Formx DDD These supplies are intended to be used only for mailing Express Mail, Priority Mail and Global Priority Mail. Misuse may be a violation of Federal Law.

PCF12010

Figure 12-10. An example of an Express Mail, Priority Mail, and Global Priority Mail Order Form.

## RECEIVING USPS POSTAL SUPPLIES

**Learning Objective:** Recall the procedures for documenting receipt of USPS supplies.

The Material Distribution Center will fill requisitions within 24 hours after receipt. The supplies requisitioned will be enclosed in a shipping container along with a Shipping Order, which is a computer printout invoice indicating the action taken by the Distribution Center (see figure 12-11).

Once supplies are received at your MPO:

- Check the supplies received against the Shipping Order and your post office copy of PS Form 7380 to ensure all items requisitioned were received. When an item is not received and the Shipping Order does not reflect the reason for non-shipment, report the discrepancy to the MDC by memo or call the 1-800 telephone number provided on the Shipping Order to check the order status. If submitting a memo, provide a copy of the PS Form 7380 from your post office files and a copy of the Shipping Order that was sent to you with the shipment. Record the discrepancy for that particular item on PS Form 1586.
- Annotate on the appropriate PS Form 1586 the amount of supply items received (see figure 12-12). Upon completion, file the Shipping Order in your post office files.

## SUPPLY STORAGE

**Learning Objective:** Recall the proper storage and maintenance procedures for postal supplies.

Supplies should be maintained in an area designated for storage of postal supplies. Your post office supplies are expected to last a given length of time. If you are wasteful, or fail to store supplies properly, your stock level may become depleted to the extent that postal operations are hampered.

A well organized storage area permits easy access to supplies. Therefore, supply clerks should establish a location numbering system to aid in locating each item. At a large shorebased MPO such as an FMC, space should be allocated for the storage of large volumes of supplies. At a small shipboard MPO, a filing cabinet may serve this purpose.

## MONITORING SUPPLIES

Supply clerks monitor supplies using PS Form 1586. A separate PS Form 1586 is maintained for each USPS supply item. PS Form 1586 must reflect the following:

- The appropriate PS item/form number
- National Stock Number
- A brief (item/form) description

Shipment No. 0021518E97400025		Shipping Order Material Distribution Center United States Postal Service TOPEKA, KS			Page:1				
		Shipping Address TECHNICAL WRITER MIL PSTL NETPMSA 6490 SAUFLEY FIELD RD PENSACOLA, FL 32509-5237			Ship Date 08/02/2000				
SOD T0025	Fedstrip 18E974								
PSN/PSIN	OEM No	Desc.	Unit Cost	Ed Date	BPQ	U/M Qty Ordered	Qty Shipped	Ship Value	NMICS Location
Customer Order No E97402148 7530-01-000-9367 PS1590 FORM, SUPPLIES AN .056 0591 1200 SH 5 5 .28 PS1590 Total Ship Value: .28 TOPEKA OPERATIONS HAS TWO AUTOMATED OPTIONS AVAILABLE 24 HOURS A DAY. BY CALLING 1-800-332-0317 AND PRESSING OPTION 2, YOU GET ORDER STATUS OF AN ITEM, OPTION 3 GIVES ITEM INFORMATION									
x									

PCF12011

Figure 12-11. An example of an MDC Shipping Order.

PS Item/Form/Part No. PS FORM 3806					National Stock No.					Bin Location					
Description RECEIPT FOR REGISTERED MAIL										Unit Price					
Unit Of Issue SE					Source Of Supply MDC				Maximum Level 500			Minimum Level 300			
Balance On Hand		Issued		Received		Ordered		Balance On Hand		Issued		Received		Ordered	
Date	Qty	Date	Qty	Date	Qty	Date	Qty	Date	Qty	Date	Qty	Date	Qty	Date	Qty
INVENTORY		02 JAN 2001													
2JAN	500	1FEB	350												
1FEB	150					5FEB	350								
				7MAR	350										
7MAR	500														

PS Form 1586, November 1985

**SUPPLY RECORD**

☆ U.S.G.P.O.: 1989-242-531/92035

PC12012

**Figure 12-12. An example of a PS Form 1586 showing supplies received.**

- Unit of issue
- Source of supply
- Maximum and minimum levels
- Balance on hand
- Quantity issued, received, and ordered

Information on the ordering of supplies can be found in USPS Publications 223 and 247, and OPNAVINST 5112.6 appendix B.

NOTE: The maximum and minimum levels will be entered in pencil to allow for adjustment when requirements change. Occasionally, the USPS will introduce a new item that will cause deletion of another item. As supply clerk for your MPO, you must ensure changes are annotated in the post office copy of USPS Publication 223 and on PS Form 1586. You will find these changes in the Postal Bulletin your office receives on a biweekly basis.

**INVENTORY CONTROL**

Inventory control establishes the minimum and maximum stock quantity. By maintaining an accurate stock level, you will have sufficient USPS postal supply items available at all times and will not run out. As a minimum, postal supplies will be inventoried on a semi-annual basis (during the months of January and July). Inventories help determine if supply records are

accurate, if established minimum and maximum levels need to be adjusted, and if supplies need to be ordered. The inventory count is recorded on PS Form 1586.

MPOs should maintain at least a 3-month but not more than a 5-month level of supplies. Consideration should be given to the amount of time it takes to receive supplies from the Material Distribution Center.

If you are stationed on a ship and are deployed, be sure you have enough postal supplies to last at least 5 months.

**SPECIAL ITEMS**

---

**Learning Objective:** *Recall the procedures for requisitioning special supply items.*

---

There are certain items that are not requisitioned on PS Form 7380. These items are unique, and normally the USPS or a contractor must specially manufacture them.

**SPECIAL ORDER RUBBER STAMPS**

Special order rubber stamps should be ordered on PS Form 1567, Requisition for Rubber and Steel Stamps Only, from the applicable JMPA. List these

items as number 502. Individualized special rubber stamps Navy post offices may need to order are:

- Postal Finance Officer
- COPE
- Postal Officer
- Directory Service stamps

These rubber stamps are only ordered for use in association with official postal business.

### **POSTMARKING EQUIPMENT (RUBBER AND STEEL STAMPS)**

Rubber stamps should be requisitioned on PS Form 1567 (see figure 12-13). All information required on PS Form 1567, should be entered on the form. When ordering rubber postmarking and canceling stamps (Item 550), and rubber all-purpose dating stamps (Item 570), type or write the information that you would like on the stamps in the impression and description block of PS Form 1567. Requisitions should be submitted to the appropriate JMPA for processing. Die Hubs for postage meter machines and canceling machines are ordered on PS Form 4636, Postmarking Dies and Engraved Station Die Hubs Requisition. PS Form 4636 must also be submitted to the appropriate JMPA for processing.

### **YEAR TYPE**

Year type for steel postmarking stamps and canceling machines are requisitioned from MDC Topeka, KS, on PS Form 7380. A notice will appear in the Postal Bulletin, normally during the month of September, informing offices of the date that the year type will be available for issue. The requisition must list year type only, and a self-addressed USPS penalty label must be stapled to the requisition. Do not request any other items on this special requisition.

If your MPO has previously been issued a year type, the MDC will contact your office via postcard in September informing you of the year type that will automatically be shipped. If your MPO needs a different quantity or type, make the changes on the postcard and return it to the MDC. If changes are not required, do not return the postcard. Detailed instructions are printed on the postcard.

### **FACING SLIPS AND SLIDE LABELS**

Preprinted facing slips and slide labels are used to identify the contents of a mail tray, bundle, or pouch of mail.

The data to be printed should conform to the format and content as outlined in USPS Handbook PO-423, Requisitioning Labels. Requisitions for preprinted facing slips and slide labels should be submitted using PS Form 1578-B, Requisitions for Facing Slips or Slide Labels in duplicate. Send PS Form 1578-B to:

US POSTAL SERVICE  
LABELING PRINTING CENTER  
500 SW MONTARA PKWY  
TOPEKA KS 66624-9502

Prepare PS Form 1578-B as follows (see figure 12-14):

#### Header Data:

Columns 1 through 9: Enter the MPO ZIP + 4 number.

Columns 13 and 14: Enter the two-digit character code for the item you are ordering.

Columns 18 through 23: Enter the MPO finance number.

Columns 24 through 49: Enter FPO, postmaster of address designation, and the nine-digit MPO number. Shipboard post offices should enter the name and hull number of the ship.

Columns 58 and 59: Enter the total number of pages, (i.e., 1 of 1, 1 of 2).

#### Detail Data Lines:

Columns 8 through 12: Enter the quantity of labels requested in multiples of 300 and facing slips in multiples of 300.

Columns 13 through 33: Enter the destination information in this block. Use standard abbreviations from the POM and ensure format is in compliance with the requirements found in the DMM. For empty equipment label orders (nondefective and defective), put "EMPTY EQUIPMENT" in these blocks.

Columns 34 through 38: Enter the destination ZIP Code (3 or 5 digits).

Columns 42 through 64: Enter the contents identification description such as, FCM or LETTERS AND FLATS, etc.





# Requisition for Rubber and Steel Hand Canceling Stamps

(See instructions on reverse)

1. Date	2. Request Number	3. Signature of Authorizing Official
---------	-------------------	--------------------------------------

**Requestor Information**

4. Name	5. Telephone Number ( )
---------	----------------------------

6. Deliver To (Name and office):
----------------------------------

7. Address
------------

8. City	9. State	10. ZIP + 4
---------	----------	-------------

11. Method of Payment (Check one)		
<input type="checkbox"/> USPS Credit Card (Include number and expiration date)	<input type="checkbox"/> Check	<input type="checkbox"/> Money Order
Credit Card No.: _____	Expiration Date: _____	Name of Credit Card Holder: _____

12. Item Number	13. Quantity	12. Item Number	13. Quantity
-----------------	--------------	-----------------	--------------

Impression or Description	Impression or Description

12. Item Number	13. Quantity	12. Item Number	13. Quantity
-----------------	--------------	-----------------	--------------

Impression or Description	Impression or Description

**Figure 12-13. An example of a PS Form 1567.**

Columns 65 through 67: Enter the three-letter air stop code. This identifies the destination airport such as JFK.

Phone number column: Enter your MPO's area code and phone number.

Total bulk column: Enter the total number of facing slips or slide labels requested.

Label clerk column: Enter the Supply Petty Officer's name.

U.S. Postal Service  
**REQUISITION FOR FACING SLIPS OR LABELS**

Header Data																										
1	2	3	4	5	6	7	8	9	10	11	12	13	14	15	16	17	18	23	24	49	50	51	52	57	68	59
Origin ZIP +4													Enter Only One Character Per Block													
Set No.													Bottom Label Line (Origin City, State & ZIP Code)													
Prod. Code (See below)													Finance No.													
Set Type (D) DMM (I) Collated (C) Scheme (S) Request													Requestor Code (P) Post Off. (M) Mailer													
Activity Code (T) Temp. Bulk (N) New Labels (O) Delete (R) Request													Number of Sets Needed Daily													
Mo													Date													
Year													Last Revision Date													
Total Pages													Page of													

**Fill The Two (2) Character Spaces of Product Code Above Using Values Listed Below:**

- A1 - Bulk Barcoded Strip White
- A2 - Bulk Barcoded Strip Pink
- A3 - Bulk Barcoded Large White
- A4 - Bulk Barcoded Large Pink
- A5 - Bulk Non-barcoded Strip White
- A6 - Bulk Non-barcoded Strip Pink
- A7 - Bulk Non-barcoded Large White
- A8 - Bulk Non-barcoded Large Pink
- A9 - Bulk Strip Foreign Blue
- A0 - Bulk Strip Foreign Orange
- AD - Bulk Strip Defective Empty Equipment
- AE - Bulk Strip Empty Equipment
- BE - Bulk Large Strip White
- EG - Collated Strip White
- D9 - Collated Non-barcoded Strip White
- EN - Collated Strip Pink
- F9 - Collated Large White
- G9 - Collated Facing Slips
- S9 - Scheme Cards

**Identification Lines (Collated Sets Only)**

Stack Header Label Lines for Set (Free Form)	
LN 2	60
LN 3	
LN 4	

**Detail Data Lines (Only One Detail Data Line Can Be Used For Any One Label Item)**

Line	Address No.	New Address	Quantity (Must be left justified)	Destination (Line 2 of Labels or Slips) Enter Only One Character Per Block	Destination ZIP (Must be left justified)	Mail Type (C/N)	Contents Identification Description Enter Only One Character Per Block	Airport Stop Code	Delivery Standard Code								
1	1	2	3	4	5	6	7	8	9								
2	10	11	12	13	33	34	38	39	33	42	64	65	67	68	72	73	74
3																	
4																	
5																	
6																	
7																	
8																	
9																	
10																	
11																	
12																	
13																	
14																	
15																	

Total Bulk	Phone No. (Include Area Code)	Reviewed By MSC/Division	Dispatch	Entered By	Verified By
	Label Clerk Name (Print)				

PS Form 1578-B, May 1992

See Reverse of This Form and Hbk. PO 423 for Instructions

LPC Copy 1

PC12/014

Figure 12-14. An example of a PS Form 1578-B.

Reviewed by MSC/Division column: Signature of postal officer or MPO supervisor.

## **PREPRINTED TAGS AND LABELS**

Preprinted military tags and labels must be requisitioned from the USPS on an as-needed basis. A PS Form 1957-C, Request for Military Tags, used to order PS Tags 135 and 135C, (see figure 12-15), and a PS Form 1957-D, Request for Military Labels, used to order PS Labels 136 and 136C (see figure 12-16), must be submitted to:

MILITARY MAIL OPERATIONS  
475 L-ENFANT PLAZA SW  
8TH FL RM 370  
WASHINGTON DC 20260-7103

No more than a 3-month supply of tags and labels should be requisitioned. The postal supply clerk must make sure quantities requested are in multiples of 1,000 only. Nonreceipt of requisitions within 60 days from submission of the requisition must be reported to MPSA-OP. Provide a copy of the requisition when reporting nonreceipt.

## **DISPOSITION OF USPS EQUIPMENT AND SUPPLIES**

---

**Learning Objective:** *Recall the procedures for properly disposing of USPS equipment and supplies.*

---

Capital and sensitive equipment that is not needed by an operational MPO should be reported by naval message to the serving JMPA for coordination of return with the USPS. The message should identify the equipment by description, item number, quantity, and serial number. In addition, any available information regarding an existing need at another shipboard MPO or shorebased MPO should be included in the message. This action should be coordinated with the FLTCINC postal officer, as appropriate.

When capital or sensitive equipment is processed according to disposition instructions received from the appropriate JMPA, a new PS Form 1590, Supplies and Equipment Receipt, should be completed and submitted in duplicate to the NPFO. The NPFO will return the original copy to relieve the COPE of accountability for the returned item.

Non-capital and non-sensitive equipment determined to be in excess should be reported to the FLTCINC postal officer and disposition instructions requested. Nonaccountable equipment transferred to another MPO should be receipted for on the receiving unit or installation's property books, as appropriate, and the command transferring the equipment should remove it from their property book. This action is required to ensure that proper accountability is maintained to include property disposal actions.

All other items, such as forms, labels, tags, and regular supply items, should be transferred to another MPO or destroyed. An exception to the above procedure applies if the postal activity is located in CONUS, in which case all excess items are returned to the local serving post office.

When an MPO is closed or deactivated, the procedures in the previous paragraphs apply in disposing of all USPS capital and sensitive equipment, DOD non-capital and non-sensitive equipment, and all other postal supplies. A message will be provided by the FLTCINC with specific instructions on the disposition of locally needed supply items.

The postal officer and/or the COPE should be aware constantly of the condition of USPS equipment assigned to their areas of responsibility.

## **ORDERING POSTAL PUBLICATIONS**

---

**Learning Objective:** *Recall the procedures for ordering USPS, DOD, and OPNAV publications.*

---

As stated earlier in this training manual, sources of information (publications) are one of the most important assets for the operation of any MPO. If your MPO is not on the automatic distribution list to receive USPS publications required to be maintained at Navy post offices, you should submit a naval message to MPSA, info copy to your FLTCINC Postal Officer, requesting your command be added to the list. If your publications become damaged or are missing pages, then order replacement publications direct from MDC Topeka, KS using PS Form 7380. If your MPO is located in CONUS, you can use the TTOES method for requisitioning replacement of USPS publications.

DOD postal publications are written by MPSA to provide uniform administration of postal functions for

U.S. POSTAL SERVICE REQUEST FOR MILITARY TAGS		TAGS (135) REQUESTED (Check type) <input type="checkbox"/> 135 <input type="checkbox"/> 135-B <input type="checkbox"/> 135-C <input type="checkbox"/> 135-E		DATE
SHIPPING ADDRESS		CONTACT		TEL. NO. (Commercial)
ALPHA (a)	CITY (b)	COUNTRY (c)	KEY CODE (d)	QUANTITY REQUIRED (e)
ADA	ADANA	TURKEY		
ADA	INCIRLIK AB	TURKEY		
AGP	MALAGA	SPAIN		
AHB	ABHA	SAUDI ARABIA		
AHO	ALGHERO SARDINIA	ITALY		
AJA	AJACCIO	FRANCE		
AKL	AUCKLAND	NEW ZEALAND		
AKT	AKROTIRI	CYPRUS		
AMM	AMMAN	JORDAN		
AMS	AMSTERDAM	NETHERLANDS		
ANC	ANCHORAGE	ALASKA (USA)		
AQJ	AGABA	JORDAN		
ASP	ALICE SPRINGS	AUSTRALIS		
ASU	ASUNCION	PARAGUAY		
ATH	ATHENS	GREECE		
ATL	ATLANTA	GEORGIA (USA)		
AVB	AVIANO	ITALY		
AWK	WAKE ISLAND			
BAH	BAHRAIN	BAHRAIN		
BDS	BRINDISI	ITALY		
BER	BERLIN	GERMANY		
BEY	BEIRUT	LEBANON		
BHE	BLENHEIM	NEW ZEALAND		
BIA	BASTIA	FRANCE		
BKK	BANGKOK	THAILAND		
BOG	BOGOTA	COLOMBIA		
BOS	BOSTON	MASSACHUSETTS (USA)		
BRU	BRUSSELS	BELGIUM		
BUE	BUENOS AIRES	ARGENTINA		
CAG	CAGLIARI SARDINIA	ITALY		
CAI	CAIRO	EGYPT, UNITED ARAB REP. OF		
CAR	CARTAGENA	SPAIN		
CBR	CANBERRA	AUSTRALIA		
CCS	CARACAS	VENEZUELA		
CHC	CHRISTCHURCH	NEW ZEALAND		
CHQ	KHANIA CRETE	GREECE		
CHS	CHARLESTON	SOUTH CAROLINA (USA)		
CLY	CALVI	FRANCE		
CJU	CHEJU	KOREA		
CMB	COLOMBO	SRI LANKA		
CPH	COPENHAGEN	DENMARK		
CND	CONSTNATA	ROMANIA		
CRK	CLARK AFB	PHILIPPINES		
CTW	CROTONE	ITALY		
CUA	CUBI POINT	PHILIPPINES		
DFW	DALLAS	TEXAS (USA)		
DHA	DHAHRAN	SAUDI ARABIA		
DIY	DIYARBAKIR	TURKEY		
DNA	KADENA AB	OKINAWA		
DOH	DOHA	QATAR		
DOV	DOVER AB	DELAWARE (USA)		
DTW	DETROIT	MICHIGAN (USA)		
DXB	DUBAI	UNITED ARAB EMIREATES		
EDF	ELMENDORF AB	ALASKA (USA)		

Figure 12-15. An example of a PS Form 1957-C.

U.S. POSTAL SERVICE REQUEST FOR MILITARY LABELS		LABELS (136) REQUESTED (Check type) <input type="checkbox"/> 136 <input type="checkbox"/> 136-B <input type="checkbox"/> 136-C <input type="checkbox"/> 136-E		DATE
SHIPPING ADDRESS		CONTACT		TEL. NO. (Commercial)
ALPHA (a)	CITY (b)	COUNTRY (c)	KEY CODE (d)	QUANTITY REQUIRED (e)
ADA	ADANA	TURKEY		
ADA	INCIRLIK AB	TURKEY		
AGP	MALAGA	SPAIN		
AHB	ABHA	SAUDI ARABIA		
AHO	ALGHERO SARDINIA	ITALY		
AJA	AJACCIO	FRANCE		
AKL	AUCKLAND	NEW ZEALAND		
AKT	AKROTIRI	CYPRUS		
AMM	AMMAN	JORDAN		
AMS	AMSTERDAM	NETHERLANDS		
ANC	ANCHORAGE	ALASKA (USA)		
AQJ	AGABA	JORDAN		
ASP	ALICE SPRINGS	AUSTRALIS		
ASU	ASUNCION	PARAGUAY		
ATH	ATHENS	GREECE		
ATL	ATLANTA	GEORGIA (USA)		
AVB	AVIANO	ITALY		
AWK	WAKE ISLAND			
BAH	BAHRAIN	BAHRAIN		
BDS	BRINDISI	ITALY		
BER	BERLIN	GERMANY		
BEY	BEIRUT	LEBANON		
BHE	BLLENHEIM	NEW ZEALAND		
BIA	BASTIA	FRANCE		
BKK	BANGKOK	THAILAND		
BOG	BOGOTA	COLOMBIA		
BOS	BOSTON	MASSACHUSETTS (USA)		
BRU	BRUSSELS	BELGIUM		
BUE	BUENOS AIRES	ARGENTINA		
CAG	CAGLIARI SARDINIA	ITALY		
CAI	CAIRO	EGYPT, UNITED ARAB REP. OF		
CAR	CARTAGENA	SPAIN		
CBR	CANBERRA	AUSTRALIA		
CCS	CARACAS	VENEZUELA		
CHC	CHRISTCHURCH	NEW ZEALAND		
CHQ	KHANIA CRETE	GREECE		
CHS	CHARLESTON	SOUTH CAROLINA (USA)		
CLY	CALVI	FRANCE		
CJU	CHEJU	KOREA		
CMB	COLOMBO	SRI LANKA		
CPH	COPENHAGEN	DENMARK		
CND	CONSTNATA	ROMANIA		
CRK	CLARK AFB	PHILIPPINES		
CTW	CROTONE	ITALY		
CUA	CUBI POINT	PHILIPPINES		
DFW	DALLAS	TEXAS (USA)		
DHA	DHAHRAN	SAUDI ARABIA		
DIY	DIYARBAKIR	TURKEY		
DNA	KADENA AB	OKINAWA		
DOH	DOHA	QATAR		
DOV	DOVER AB	DELAWARE (USA)		
DTW	DETROIT	MICHIGAN (USA)		
DXB	DUBAI	UNITED ARAB EMIREATES		
EDF	ELMENDORF AB	ALASKA (USA)		

Figure 12-16. An example of a PS Form 1957-D.

all military services. Within the Navy, DOD publications are reissued as OPNAV instructions and the DOD publications are actually enclosures to these OPNAV instructions.

OPNAV postal instructions required for the operation of an MPO are available from the Commander Naval Supply Systems Command (COMNAVSUPSYSCOM) web site. If your MPO does not have Internet access, request assistance from your supply office in obtaining these instructions.

*Q12-12. What is the purpose of a shipping order?*

*Q12-13. Shipboard MPOs should maintain at least a 3-month level but not more than a 5-month level of USPS expendable supplies on board. (True/False)*

*Q12-14. What PS form would you use to order postmarking equipment?*

*Q12-15. What PS form would you use to order facing slips?*

*Q12-16. What PS forms would you use to order preprinted military tags and labels?*

*Q12-17. What PS form would you use to order USPS publications?*

*Q12-18. Department of Defense postal publications are reissued as OPNAV instructions. (True/False)*

*Q12-19. What department within your command can assist you in obtaining OPNAV postal instructions?*

Now turn to appendix 1 to check your answers.

## CHAPTER 13

# OFFICIAL MAIL

Official mail is any letter, publication, parcel or other mailable item relating exclusively to the business of the U.S. Government, and mailed as penalty mail or mail on which postage and fees have been prepaid.

Penalty mail is official mail on which postage and fees are paid by either a penalty metered indicia, penalty permit indicia, penalty mail stamps, penalty business reply and merchandise return indicia, or standard penalty indicia. Penalty postage is paid for after mailing versus prepaid postage paid for when obtained.

Navy commands use commercial postage meters (see figure 13-1), commercial postage stamps, or computer generated postage to prepay postage on letters, flats, publications, or parcels, etc.

### NAVY OFFICIAL MAIL COST CONTROL PROGRAM (NOMCCP)

---

**Learning Objective:** *Recall the procedures for establishing and managing a command official mail cost control program (OMCCP), including accountability requirements and treatment of official mail.*

---

The NOMCCP, the Navy's program to reduce postage costs is not new, and all Postal Clerks are involved to some extent in official mailings and, therefore, should have knowledge of this program.

Before the NOMCCP there was no requirement to put postage on outgoing official mail. Each DOD component had a unique code to identify mailings from their activities. This code was preprinted in the upper right-hand corner of envelopes and mailing

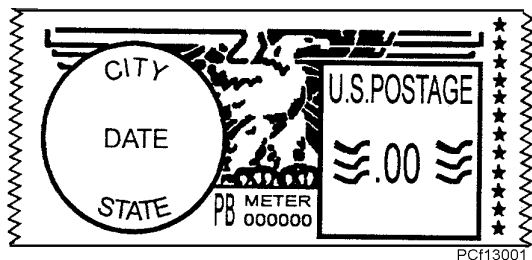

Figure 13-1.—An example of a postage meter tape.

labels. To receive reimbursement for handling and transporting mail originating at DOD activities, the USPS conducted periodic samplings of government mail. Based on this sampling system, each DOD component headquarters received a postage bill. Because commanders and commanding officers were not paying for postage out of their operating funds there was little interest in reducing costs.

From 1988 to 1994 the Navy used penalty postage and meters to account for postage for official mailings with the postage bill for the entire Navy paid for by the Chief of Naval Operations. In October of 1994, the Navy converted to commercial postage and payment for postage was decentralized down to the user level. Positive accountability and control of the NOMCCP was then achieved by requiring host installations to budget for their postage expenditures (pay as they go) and by monitoring or surveying outgoing and incoming official mail for proper preparation and correct postage. This positive accountability and control is achieved by making sure each command has an Official Mail Cost Control Program (OMCCP) and an appointed official mail manager (OMM) to provide oversight of the program.

The overall goal of the NOMCCP is to reduce official mail costs. This is accomplished through cost-effective use of the USPS, DOD Official Intra-Theater Mail, guard mail, and alternate carriers such as Federal Express, or United Parcel Service. Consolidating mail to as many locations as possible is another way in which the Navy has reduced postage costs.

The DOD Official Mail Manual, DOD 4525.8-M, which is supplemented by the Navy Official Mail Management Instruction, OPNAVINST 5218.7, provides the necessary guidelines for Navy commands to establish a viable official mail cost control program.

Every Navy command must have a command OMCCP to review mailing practices. The purpose of this program is to ensure official mailings are prepared and processed efficiently, in a timely manner, and at the least cost based on mission needs as directed by:

- USPS regulations.

- *Navy Official Mail Management Instruction*, OPNAVINST 5218.7, supplements policies and procedures outlined in the *DOD Official Mail Manual* and emphasizes the use of the class of mail, and special and supplemental postal services that meet the security, accountability, and delivery requirements of the material being shipped at the most economical cost to the Government.
- *DOD Official Mail Manual*, DOD 4525.8-M, provides information and guidelines for implementing the DOD OMCCP. This manual also explains control and safeguard procedures for postage meters and postage stamps.
- Command Standard Operating Procedures (SOP) for official mail.

Other publications and related items used in the official mail program are:

- *USPS Domestic Mail Manual (DMM)*. The DMM is the primary USPS manual used in mail operations. It contains regulations of direct interest to mailers such as postage rates, mail classifications, and mail preparation guidelines. It must be used at each official mail acceptance site. The activity's OMM and host commander's activity OMM also must have access to a DMM.
- *USPS International Mail Manual (IMM)*. The IMM contains regulations, classifications, and other guidelines for mailing between the United States and foreign countries. This publication is only required where international mail is frequently accepted.
- *USPS Postal Bulletin*. This bi-weekly publication provides updates to the DMM and IMM, as well as other information on mail-related items.
- *Postage Rates and Fees*, USPS Poster 123-L or 123-S. These posters are used at each location where domestic postage rates are calculated.
- *International Rates and Fees*, USPS Poster 51. This poster is used at each location where international postage rates are calculated.
- *Postal Zone Chart*. This chart lists the zones in which the various ZIP Codes are located in relation to your local mailing address. Use this chart at each location where postage rates are calculated.

When the publications and instructions mentioned are on hand at the official mail acceptance site, operating and control procedures can then be established to make sure official mail is quickly delivered, processed, and dispatched correctly. An official mail program must also include proper safeguards and security controls to prevent the depredation of official mail or the compromise of any classified material. Guidance on these issues is contained in DOD 4525.8-M and OPNAVINST 5218.7.

In addition to required publications, instructions, and notices, your command's official mail acceptance site will need (depending on the size and scope of the operation) either a 16-ounce, 4 pound, and/or a 70-pound mechanical or electronic scale(s). This equipment is used to weigh articles to determine the amount of postage required on outgoing official mail.

Be aware of unauthorized uses of official mail. Make sure you notify the OMM of all incidents of unexplained missing, misdirected, or delayed official mail.

#### **APPOINTMENT OF OFFICIAL MAIL MANAGERS (OMMS)**

Installations, activities, and staff elements must appoint OMMs. Commanders may appoint assistant OMMs to perform the OMM duties when the OMM is absent. The OMM appointment may be a collateral duty assignment. The commander must make the appointment by official letter. Include the appointee's official address, e-mail address, and telephone number in the letter. Distribute copies as follows:

- Staff element OMMs, send copies to their command OMM.
- Command OMMs, send copies to their next higher command's OMM.
- Tenant command OMMs, send copies to their host installation OMM.

OMMs must be an E-6 or above, or a DOD civilian GS-6 or higher. This requirement is waived only when the command concerned has no personnel in the grades specified.

#### **DIRECT ACCOUNTABILITY**

Direct accountability is a term with which everyone in the Navy is familiar. The Navy, like all the other branches of the military services, is directly



responsible for controlling, managing, and accounting for each postal dollar spent. The Navy's annual postage costs for official mailings is approximately 25 million dollars; and since postage rates continue to rise and will in the future, you can see why tight control is a must.

The success of a command Official Mail Cost Control Program requires the support, cooperation, and sometimes the technical expertise of a Navy Postal Clerk.

## **TREATMENT OF OFFICIAL MAIL**

Official mail must conform to the weight, size, and shape requirements for the class of mail being used. All official mail must be treated as First-Class Mail, unless endorsed for a lower class. **EXCEPTION:** Pieces exceeding the weight limits of First-Class Mail must be treated as Standard Mail (B) unless endorsed **PRIORITY**. Refer to Module R of the DMM for weight restrictions. Official mail endorsed to indicate a special mail service must be given the service indicated. Official mail sent to International addresses must conform to the size and weight limits and restrictions of the country to which addressed. A return address is required on all official mail. The words "DEPARTMENT OF THE NAVY" must be above the return address, and the words "OFFICIAL BUSINESS" below the return address. All addresses and return addresses must have a ZIP + 4 Code.

## **SPECIAL MAIL SERVICES**

The Department of the Navy has placed certain limitations on the use of special mail services and the transmission of official mail as follows:

Registered mail should be used only for the transmission of the following types of materials:

- Classified material as required by DODINST 5200.1-R.
- Service records, medical records, and records of courts-martial.
- High-value items that are one-of-a-kind, irreplaceable, sensitive, controlled, rare or pilferable, and items having a replacement value in excess of \$20,000.
- Mailable shipments of government owned firearms.\*
- Criminal investigation evidence.

- Cash, original vouchers (disbursement and collection), and voided or cancelled checks.
- Commercial transportation tickets, boarding passes, and Air Mobility Command authorizations.
- Environmental samples.\*
- Notification of radiation exposure.\*
- Miling former evidence to its owner.\*
- Mobilization preassignment orders to International addresses where this service is authorized.\*
- Items required by law, regulation, or other government agency rules with which the Navy must comply.

### **\* Use of a USPS Return Receipt is authorized for these items.**

Insured mail will be used only for:

- Motion pictures sent from or to the Navy Motion Picture Exchange command.
- For accountability reasons when proof of delivery is required for valuable administrative or logistical equipment, supplies, and printed matter.
- To return borrowed library books and similar items when required by the non-DOD lender.

No other special service will be used in conjunction with insured mail. Mail being sent registered or certified will not be insured.

Certified mail will be used only for:

- Confidential material to facilities cleared for access to classified information under the DOD Industrial Security Program or to any non-DOD agency of the Executive Branch.
- Letters to establishments being declared "off limits."
- Adverse enlisted and officer efficiency reports and other similar actions.
- Controlled test material.
- Instructional material marked "For Faculty Use Only."
- Items requiring shipment by Priority Mail when the certified fee is less than the fee for other services which provide proof of delivery.

- Equal employment opportunity case material mailed to complainants and their representatives.
- Reduction in force notices sent to civilian employees on authorized absence.
- Final decisions of a contracting officer issued under the dispute clause of a government contract.
- Show cause or cure notices issued under the default clause of a government contract.
- Any other communication for which receipt is essential to create or preserve rights granted to the United States under a government contract.
- Debarment letters.
- Delayed entry packages.
- Summonses and subpoenas.
- Adverse personnel actions for military and civilian personnel.
- Illegally held identification cards.
- Traffic or driving violations.
- Letters of revocation or suspension of installation driving privileges.
- Dishonored checks (not applicable to non-appropriated fund instrumentality's).
- Questions to injured persons.
- Records of trial for all Special and General Courts Martial.
- Decisions of the courts of military review.
- Officer elimination cases.
- Any other communication; receipt of which is essential to create or preserve the rights granted to the U.S. Government in connection with criminal proceedings.

**\* Use of a USPS Return Receipt is authorized for these items.**

Return receipts will be used only when:

- Proof of delivery of official mail to a non-government addressee is required. If proof of delivery to another government agency is required, an internal receipt, OPNAV Form 5511/10, Record of Receipt (see figure 13-2) will be used and the addressee will be instructed to acknowledge receipt of the mailing by completing the form and returning it immediately.

OPNAV 5511/10 (Rev 12-89) S/N 0107-LF-008-8000		<b>RECORD OF RECEIPT</b> (REFERENCE OPNAVINST 5510.1H)			THIS RECEIPT MUST BE SIGNED AND RETURNED	
ORIGINATOR'S CODE	FILE OR SERIAL NO.	DATE OF MATERIAL	UNCLASSIFIED DESCRIPTION	COPY NO.	NO. OF ENCLS TO MAT'L RCD	
ADDRESSEE (Activity Receiving Material)				REGISTERED NUMBER		
SIGNATURE (Authorized Receipt)				DATE		

PC113002

**Figure 13-2.—An example of an OPNAV Form 5511/10.**

- Required by law, regulation, or the rules of another government agency with which the Navy must comply.

## EXPRESS MAIL

Express Mail is the class of mail afforded the highest priority in handling and provides highly reliable service. Express Mail shall be used only when it is the most cost-effective way to accomplish a mission within time, security, and accountability constraints. It shall not be used:

- To respond to directed actions or requests for information unless using it is the only way to meet a short suspense.
- For the purpose of correcting administrative oversights such as a late suspense when adequate time existed to meet a deadline.
- On days before weekends or holidays unless the sender has verified, someone will be available to accept the item being sent and work on it during the weekend or holiday.

## MILITARY ORDINARY MAIL

Military Ordinary Mail (MOM) is official mail sent at the Periodicals or Standard Mail postage rates that requires faster service than sealift transportation to overseas MPO areas. MOM service is not available on articles mailed in and addressed for delivery in the United States. MOM service provides for the airlift of those official articles that qualify for and are endorsed MOM. The MOM endorsement will be in addition to any other endorsements on the article and will be placed on the address side of the article.

## BALLOTING MATERIALS

Another type of official mail that you may handle is absentee balloting material (see figure 13-3). Members of the military services on active duty, and DOD civilian personnel and their dependents use these materials. Other U.S. citizen civilian personnel in a foreign country may also deposit balloting material at MPOs even though they may not be authorized other postal privileges. All printing on balloting material is printed in red for easy identification. Postage will not be placed on these mailings. All balloting material will be postmarked with a cancellation device to show date of mailing.

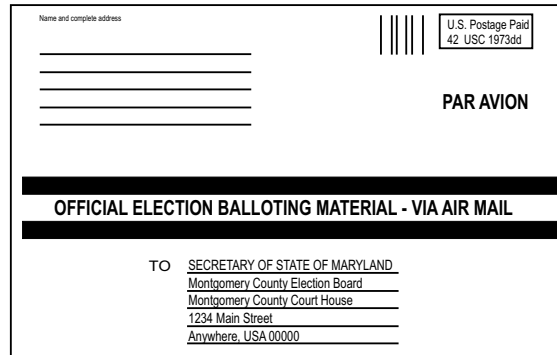
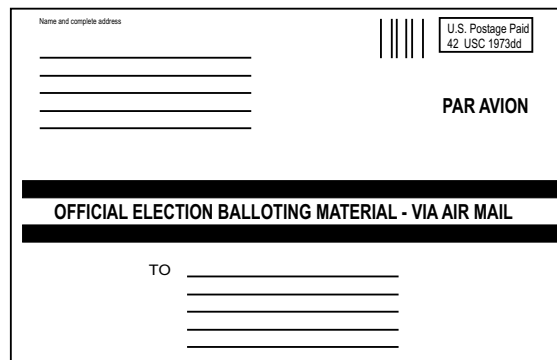

PCf13003

Figure 13-3.—Examples of balloting materials.

## USPS PENALTY MAIL

The USPS, like DOD, also has a form of official mail accounting system called penalty mail. Also like the DOD, the USPS is responsible for the control, management, and payment of postage for their program. MPOs are authorized to use USPS penalty mail when sending USPS business items or correspondence such as money order business reports, stamp requisitions, or claims and inquiry forms between USPS and MPS offices. Postage will not be placed on USPS penalty mail.

## DOD OFFICIAL INTRA-THEATER MAIL

The DOD intra-theater mail service permits all overseas (OCONUS) activities to send correspondence and materials to other APOs/FPOs within the same geographical area at no cost to the government.

Special services can be used on DOD Official Intra-Theater Mail with the same restrictions as other mail. However DOD Official Intra-Theater mail must never be allowed to enter USPS or international mail systems.

Ships and embarked mobile units deployed within a particular theater (for example, Pacific, European, and North Atlantic) are eligible to use this service for the duration of their stay. Items that become undeliverable for ships that have departed for CONUS must not be forwarded for delivery through the USPS but should be returned to the sender.

All privileges, requirements, and priorities applicable to items in the MPS apply to DOD Official Intra-Theater Mail. This includes protection and security against theft and depredation, adherence to service standards, protection from unauthorized search and seizure procedures, and compliance with customs requirements.

- Q13-1. What is the definition of official mail?*
- Q13-2. What is the overall goal of the Navy official mail cost control program?*
- Q13-3. A command OMM must be an active duty military or DOD civilian of what grade?*
- Q13-4. Official mail exceeding First-Class Mail weight limits with no endorsements must be treated as what class of mail?*
- Q13-5. Under what circumstances may official mail be sent as Express Mail?*
- Q13-6. Balloting material is printed in what color for easy identification?*
- Q13-7. What is the name of official mail used by the USPS?*
- Q13-8. When would your MPO use USPS penalty mail?*
- Q13-9. When will USPS penalty mail also have postage applied?*

Now turn to appendix 1 to check your answers.

## **OBTAINING AND ACCOUNTING FOR POSTAGE**

---

**Learning Objective:** *Recall the procedures for obtaining postage stamps, computer-generated postage, and postage meters; and their accounting procedures.*

---

The size of your unit or command will determine the type of postage used (postage stamps or computer-generated postage, or postage meter machine) and the type of accounting procedures you

will use. If you are assigned aboard a CVN, your command will probably have a postage meter with a small amount of postage stamps for back up if only one meter is onboard. If you are assigned aboard a DDG, your command will probably use postage stamps or computer-generated postage for all official mailings.

## **POSTAGE STAMPS**

Postage stamps are used by small volume mailers throughout the Navy. Small volume mailers most likely have an outgoing official mail volume too low to justify having postage metering equipment.

Shore activities without a second (backup) postage metering system may maintain a 10-day emergency supply of postage stamps. The emergency supply of stamps is used when metering equipment is not operational.

Deployable units may maintain a 30-day stock of postage stamps for use when deployed to areas without metering equipment. Small volume mailers must not exceed a 90-day supply of postage stamps. The command OMM must closely control postage stamps.

Stamp requisitions are submitted on PS Form 17, Stamp Requisition, to the serving MPO or civilian post office by the command OMM. Only those denominations necessary to conduct official mail business should be ordered. Check all arithmetic to make certain PS Form 17 is correct and ensure all entries are legible on all copies of the form.

The command OMM is responsible for ensuring the command has enough postage for official mailings. The procedure for obtaining funds to purchase postage stamps is as follows:

- The OMM and one alternate will file a Signature Card, DD Form 577 (see figure 13-4) with the command disbursing officer. This card authorizes the OMM to accept checks made payable to the applicable postmaster.
- The OMM prepares Standard Form 1034, Public Voucher for Purchase and Services Other Than Personal, (see figure 13-5) and submits it to the comptroller. This form describes in detail the postal services to be procured.
- The disbursing officer will prepare a Treasury check made payable to the applicable postmaster.
- The OMM or alternate picks up the Treasury check from the disbursing officer, mails or delivers it to the serving post office, and obtains a

receipt from a USPS or Navy postal representative.

- The OMM certifies on the signed post office receipt that the requested service has been received and delivers it to the comptroller.
- The comptroller attaches the post office receipt to the retained copy of the SF 1034 to serve as the receiving report.

Once postage stamps are received from the serving post office they should be logged on PS Form 3295. A PS Form 3295 should be maintained for each denomination of postage stamps and stamped paper used aboard ship, at official mail centers, or other locations where official mail is accepted. When stamps are received or issued, ensure that you make the appropriate entry on PS Form 3295 so you always have an accurate count of the postage remaining on hand.

### Daily Stamp Usage Worksheet

Official mail acceptance sites will use a variety of postage stamps and stamped paper. To aid in the daily recap of postage used, a Daily Stamp Usage Worksheet must be maintained (see figure 13-6). This worksheet is broken down into three columns. The first column is for applying a tick mark beside the denomination of stamps listed when one is used. The second column lists the different denominations of stamps that an official mail acceptance site would use. The third

column is for totaling the amount of each type of postage used at the end of the workday. At the end of the workday, the figures from the worksheet for each denomination of stamp stock used will be recorded on PS Form 3295 (Daily Record of Stamps, Stamped Paper and Nonpostal Stamps on Hand).

This worksheet is a required form and must be completed daily and retained until after the monthly audit. The form can be locally reproduced.

### Audits

Postage stamp stock used for official mail, like fixed credit accounts issued by the NPFO or a PFO must be audited monthly by the command monies audit board. The audit should be performed by two or more members of the board following the same basic guidelines as for a fixed credit account.

The auditors should use an Official Stamp Audit form, NAVSUP Form 5218/2 (see figure 13-7). This form can be locally reproduced or downloaded from the Naval Logistics Library (NLL) located on the NAVSUP website. The auditors must do a complete audit of all postage stamps and stamped paper on hand by entering the quantity and value of each item in the appropriate columns. The total value of all postage counted should be entered in the Total Value of Stamps On Hand block.

1. NAME <i>(Type or print)</i>	2. PAY GRADE	3. DATE
4. OFFICIAL ADDRESS		
5. SIGNATURE		
6. TYPE OF DOCUMENT OR PURPOSE FOR WHICH AUTHORIZED		
THE ABOVE IS THE SIGNATURE OF THE AUTHORIZED INDIVIDUAL		
7. NAME AND GRADE OF COMMANDING OFFICER <i>(Type or print)</i>	8. PAY GRADE	
9. SIGNATURE OF COMMANDING OFFICER		
DD Form 577, MAY 88	<i>Previous edition may be used until exhausted</i>	SIGNATURE CARD

PCF13004

Figure 13-4.—An example of a DD Form 577.

Standard Form 1034 Revised October 1987 Department of the Treasury 1 FPM 4-2000		<b>PUBLIC VOUCHER FOR PURCHASES AND SERVICES OTHER THAN PERSONAL</b>				VOUCHER NO.
U.S. DEPARTMENT, BUREAU, OR ESTABLISHMENT AND LOCATION			DATE VOUCHER PREPARED		SCHEDULE NO.	
PAYEE'S NAME AND ADDRESS			CONTRACT NUMBER AND DATE		PAID BY	
			REQUISITION NUMBER AND DATE			
			DATE INVOICE RECEIVED			
SHIPPED FROM			TO	WEIGHT	PAYEE'S ACCOUNT NUMBER	
GOVERNMENT B/L NUMBER						
NUMBER AND DATE OF ORDER	DATE OF DELIVERY OR SERVICE	ARTICLES OR SERVICES <i>(Enter description, item number of contract or Federal supply schedule, and other information deemed necessary)</i>	QUAN-TITY	UNIT PRICE		AMOUNT (1)
				COST	PER	
(Use continuation sheets if necessary) (Payee must NOT use the space below) TOTAL						
PAYMENT:		APPROVED FOR = \$	EXCHANGE RATE = \$1.00	DIFFERENCES		
<input type="checkbox"/> PROVISIONAL		BY 2		Amount verified; correct for		
<input type="checkbox"/> COMPLETE				<i>(Signature or Initials)</i>		
<input type="checkbox"/> PARTIAL		TITLE				
<input type="checkbox"/> FINAL						
<input type="checkbox"/> PROGRESS						
<input type="checkbox"/> ADVANCE						
Pursuant to authority vested in me, I certify that this voucher is correct and proper for payment.						
(Date)		(Authorized Certifying Officer) 2		(Title)		
ACCOUNTING CLASSIFICATION						
PAID BY	CHECK NUMBER	ON ACCOUNT OF U.S. TREASURY	CHECK NUMBER	ON (Name of bank)		
	CASH \$	DATE	PAYEE 3			
1 When stated in foreign currency, insert name of currency.			PER			
2 If the ability to certify and authority to approve are combined in one person, one signature only is necessary; otherwise the approving officer will sign in the space provided, over his official title.			TITLE			
3 When a voucher is receipted in the name of a company or corporation, the name of the person writing the company or corporate name, as well as the capacity in which he signs, must appear. For example: "John Doe Company, per John"						
Previous edition usable. <span style="float: right;">NSN 7540-00-900-2234</span>						
<b>PRIVACY ACT STATEMENT</b> The information requested on this form is required under the provisions of 31 U.S.C. 82b and 82c, for the purpose of disbursing Federal money. The information requested is to identify the particular creditor and the amounts to be paid. Failure to furnish this information will hinder discharge of the payment obligation.						

PC113005

Figure 13-5.—An example of an SF 1034.

Next, the auditors will enter the following on the audit form:

- Stamps on hand as of the last monthly audit.
- Stamps purchased since last audit (+).
- Sub Total (=).
- Stamps issued (-).
- Total (=).
- Total value of stamps on hand.
- Difference.

To complete the form, both auditors will sign and date the audit sheet. The audit sheet will be filed in the official mail files and retained for 2 years.

### COMPUTER-GENERATED POSTAGE

Some Navy commands with small volumes of outgoing official mail are using computer-generated postage instead of postage stamps. This e-commerce method of obtaining postage allows users to print postage 24 hours a day 7 days a week from a personal computer.

<b>DAILY STAMP USAGE WORKSHEET</b>		
<b>Quantity (Tick) Block</b>	<b>Denomination</b>	<b>Total Amount Used</b>
	.01	
	.02	
	.03	
	.04	
	.05	
	.10	
	.20	
	.22	
	.25	
	.33	
	.50	
	.55	
	.77	
	1.00	
	2.00	
	3.20	
	5.00	
	No. 10 Envelope .40	
<b>Grand Total</b>		
<i>Note: Maintain this worksheet on file until AFTER the next monthly audit is completed.</i>		

**Figure 13-6.—An example of a Daily Stamp Usage Worksheet.**

This method of mailing official business items costs less than postage meters, and eliminates the need for postage stamps with related detailed record keeping and monthly audit requirements.

Commands who desire to use computer-generated postage must obtain a meter license from the USPS. The meter license is requested at the same time the user purchases the software and other products required to use computer-generated postage.

When an account is established and all software and other necessary products installed, the command

desiring to use computer-generated postage must purchase postage from the USPS through the vendor via the Internet. At the time this manual was written the maximum amount of postage authorized to be purchased was \$2,500. There is a surcharge to download postage. Payment for postage is made by the command's impact Visa card.

After postage is available, items can be mailed by printing postage directly on envelopes, labels, or documents. Articles can be mailed First-Class, Priority, Express Mail, or Standard Mail (B).

<b>OFFICIAL STAMP AUDIT</b>		<b>ACTIVITY</b>
<b>DENOMINATION OF STAMP</b>	<b>NUMBER OF STAMPS ON HAND</b>	<b>VALUE OF STAMPS ON HAND</b>
.01		
.02		
.03		
.04		
.05		
.20		
.22		
.33		
.55		
.77		
1.00		
2.00		
3.20		
pn5.00		
No. 10 Envelope (.40) (each)		
.33 Cent Coils		
TOTAL VALUE OF STAMPS ON HAND		
STAMPS ON HAND AS OF THE LAST MONTHLY AUDIT		
STAMPS PURCHASED SINCE LAST AUDIT(+)		
SUB TOTAL(=)		
STAMPS ISSUED(-)		
TOTAL(=)		
TOTAL VALUE OF STAMPS ON HAND		
DIFFERENCE		
<b>AUDITOR'S TYPED OR PRINTED NAME AND SIGNATURE</b>		<b>DATE</b>

**NAVSUP Form 5218/2 (Rev 11-99)**

**Figure 13-7.—An example of an Official Stamp Audit sheet.**



## **POSTAGE METERS**

Postage meters provide a means of achieving positive accountability by imprinting the exact amount of postage paid directly on an envelope, or on a postage meter tape that is affixed to the mailing piece. The meter records the value of postage paid on official mailings.

Postage meters may not be owned, but must be leased from an authorized manufacturer. A license is required from the USPS before a postage meter can be leased to a command. The license identifies the civil or MPO where the postage meter is registered and the location and the model number of the meter.

Navy commands using postage meters are required to use the Computerized Remote Postage Meter Resetting System (CMRS). CMRS allows Navy mail centers and other postage metering sites (to include Navy ships) to add postage to their electronic or digital meters over the phone.

To establish a CMRS account, the command OMM contacts their local meter manufacturer's representative and explains the command's desire to establish a CMRS account. The meter manufacturer will establish the account and provide a 1-800 number for purposes of adding postage on the meter.

Deposits of funds to CMRS accounts must be done by electronic funds transfer (EFT). To arrange for deposits by EFT, the command comptroller or other finance personnel completes Standard Form (SF) 1034, Public Voucher for Purchases and Services Other Than Personal, and submits the form to their servicing Defense Finance and Accounting Service (DFAS). The servicing DFAS will make the EFT deposit to the CMRS account.

When additional postage is required to be set on postage meters, the command OMM calls the meter manufacturer's 1-800 number. Postage is initially set on the meter, and then the meter reset each quarter for the estimated amount of postage to be used during the quarter. Because CMRS meters electronically record meter register readings, commands are not required to manually record daily ascending and descending readings. System-generated reports received from the meter vendor after transactions are made can serve as a substitute for manual records and must be available for review by the command OMM and by inspectors.

## **POSTAGE METERING SYSTEMS**

Postage-metering systems consist of a mailing machine, electronic scale, an electronic interface between scale, an accumulator, and the postage meter. All components except the postage meter may be purchased, leased, or leased with an option to purchase. The postage meter must be leased.

The electronic scale in most cases weighs mail in 1/2-ounce increments up to 70 pounds. It computes the required postage electronically. The interface sends the required postage electronically to the metering and mailing machine. Then the interface either prints the meter imprint directly on the envelope or produces a tape with the meter imprint on it.

The accumulator is a piece of electronic accounting equipment that is connected to the scale. It records all mailings, and each command, tenant activity, department, division, or office can be assigned a separate account number. The operator can print out information gathered in the accumulator for management use in analyzing and controlling official postage costs.

## **INSPECTIONS**

Adherence to official mail management regulations, policies, and procedures is accomplished under the control of the *Navy Command Inspection Program*, SECNAVINST 5040.3.

Component headquarters, MACOMs, and intermediate commands must conduct internal headquarters OMM inspections at least once a year. Inspections of subordinate installations and activities must be conducted at least every 3 years. These inspections can be combined with other inspections and staff assistance visits.

Installation or equivalent OMMs will annually inspect all staff activities, subordinate activities, and tenant activities. These inspection reports will be made available for review during MACOM and Inspector General inspections and staff assistance visits. Staff, subordinate, and tenant activities must keep all previous inspection reports on file for a period of 3 years.

## **CHECKLIST**

The Official Mail Manager's Inspection Checklist, NAVSUP Form 5218, provided in OPNAVINST 5218.7, is used for inspections (see figure 13-8.) Local

OFFICIAL MAIL MANAGERS INSPECTION CHECKLIST				A. DATE	
For use of this form, see OPNAV 5218.7B. The proponent agency is Naval Supply Systems Command.					
B. TO (Inspected Activity)			C. FROM (Inspecting Activity)		
INSTRUCTIONS					
Mark an "X" in "YES" or "NO" column for each item. If item is not applicable, mark "NA" in "YES" column.					
References apply to OPNAV 5218.7B and DOD 4525.8-M					
ITEM	YES	NO	ITEM	YES	NO
1. Is OPNAVINST 5218.7B available ?			18. Are all business reply items prepared per Ch3, Para M1a and b of DOD 4525.8-M?		
2. Is a current copy of DOD 4525.8-M available?			19. Do permit imprint format and contents comply with Ch3, Para R1 of DOD 4525.8-M?		
3. Does the command OMM have a current copy of all publications required by Ch1, Para D of DOD 4525.8-M?			20. Are postage stamp inventories maintained IAW Ch5, Para B1 of DOD 4525.8-M		
4. Does each meter location have a current copy of all publications required by Ch1, Para D of DOD 4525.8-M?			21. Are postage stamps ordered per Ch5, Para B2 of DOD 4525.8-M?		
5. Is official mail being transported at the lowest cost to the DON per Ch2, Para B1 and 2 of DOD 4525.8-M?			22. Are postage stamps secured per Ch5, Para B3 of DOD 4525.8-M?		
6. Is unauthorized use of official mail reported per Ch2, Para B8 and Ch3 Para Q of DOD 4525.8-M?			23. Are valid USPS postage meter licenses on hand as required by Ch5, Para C1 OF DOD 4525.8-M?		
7. Are all OMMs appointed in writing in accordance with Ch2, Para C1a of DOD 4525.8-M?			24. Have expired USPS postage meter licenses been canceled per Ch5, Para C1 of DOD 4525.8-M?		
8. Are OMM appointments on file as required by Ch2, Para C1a of DOD 4525.8-M?			25. Are metering locations posting daily meter readings to PS Form 3602-A per Ch5, Para C.3 of DOD 4525.8-M?		
9. Are OMMs carrying out their training and supervisory requirements as required by Ch2, Para C2 and 3 of DOD 4525.8-M?			26. Are USPS Forms 3603 (Receipt for Postage Meter Settings) on file per Ch5, Para C.3 of DOD 4525.8-M?		
10. Is Official mail monitored in compliance with Ch2, Para C3b of DOD 4525.8-M?			27. Are refunds for spoiled postage submitted per Ch5, Para C6 of DOD 4525.8-M?		
11. Are OMMCCP inspections conducted as required by Ch2, Para C4 of DOD 4525.8-M?			28. Is the record of postage use being analyzed per Ch5, Para C6 of DOD 4525.8-M?		
12. Is maximum use being made of consolidated mailings per Para 9b of OPNAVINST 5218.7B, and Ch3 Para C of DOD 4525.8-M?			29. Are postage meters secured per Ch5, Para C9 of DOD 4525.8-M?		
13. Are consolidated mailings prepared per Ch3, Para C of DOD 4525.8-M?			30. Are postage meter keys secured per Ch5, Para C9 of DOD 4525.8-M?		
14. Are consolidated mailings dispatched daily, per Para 15d2 of OPNAVINST 5218.7B?			31. Is the postage metering equipment accounted for per Ch5, Para C10 of DOD 4525.8-M?		
15. Is mail being marked with the correct class of mail per Ch3, Para G of DOD 4525.8-M?			32. Do postage meter supplies meet requirements of Ch5, Para C11 of DOD 4525.8-M?		
16. Are special mail services being selected per Para 10 of OPNAVINST 5218.7B and Ch3, Para 1 of DOD 4525.8-M?			33. Is a record of daily usage of stamp stock recorded on PS Form 3295 or other form as required by Para 13b of OPNAVINST 5218.7B?		
17. Are all business reply items addressed to a DOD activity per Ch3, Para M1a and 2b. of DOD 4525.8-M?			34. Is stamp stock being audited monthly by the command OMM in accordance with Para 13e of OPNAVINST 5218.7B?		

NAVSUP FORM 5218 (1-99) S/N 0108-LF-982-6600

PCF13008

Figure 13-8.—An example of a NAVSUP Form 5218.

reproduction of the form is authorized. Be sure you understand the references shown at the end of each inspection item listed on the form.

To control DON official mail costs, maintain a viable OMCCP, and prepare for inspections, all OMMs must do the following on a recurring basis:

- Make sure official mail users know when and how to contact their OMM.
- Supervise mailing practices.
- Report any misuse of official mail to commanding officers of alleged violators.

<b>OFFICIAL MAIL MANAGERS INSPECTION CHECKLIST</b>					
(...Continued from front)					
ITEM	YES	NO	ITEM	YES	NO
35. Are official mail addresses, both delivery and return, formatted correctly in accordance with Para 11a and b of OPNAVINST 5218.7B?			39. Does the CMF have a five year plan in accordance with Para 15b4 of OPNAVINST 5218.7B? (CMF's Only)		
36. Has a Director of Postal Operations been appointed in writing in accordance with Para 15b1 of OPNAVINST 5218.7B? (CMF's Only)			40. Is a record of the total cost of postal support provided to each activity maintained per Para 7a5 of OPNAVINST 5218.7B?		
37. Has a Customer Service Guide been prepared for customer use in accordance with Para 15b3 of OPNAVINST 5218.7B? (CMF's Only)			41. Is accountable mail being processed correctly in accordance with Para 15h of OPNAVINST 5218.7B?		
38. Is maximum use being made of available postal discounts such as pre-sorted mail in accordance with Para 15c3 of OPNAVINST 5218.7B? (CMF's Only)					
<b>42. RATING ("X" one)</b>		<b>a. Satisfactory</b>		<b>b. Unsatisfactory</b>	
<i>Note: An unsatisfactory rating is mandatory if anyone of items 1, 2, 3, 4, or 34 is marked "NO"</i>					
43. COMMENTS					
44. INSPECTOR (Last, First, Middle Initial)					
a. NAME (Last, First, Middle Initial)		b. Grade or Title		c. Telephone Number	
d. Organization			e. Signature		

NAVSUP FORM 5218 (1-99)

PC113008A

**Figure 13-8.—An example of a NAVSUP Form 5218—Continued.**

- Set up controls on postal expenses to create a cost-effective mail management program.
  - Supervise the command's OMCCP.
- Command OMMs are required to do the following:
- Keep commanders informed of the effectiveness of the OMCCP and any problem areas.
  - Annually contact, provide assistance, guidance, training, and discuss mailing requirements with activities within their jurisdiction that produce forms, publications, and periodicals. (Keep

records of these discussions to make future inspections easier.)

- Inspect incoming mail at least once a week and report deficiencies to the originating command's OMM.
- Inspect outgoing mail at least once a week at the final preparation point to (1) decide who needs additional training and what policies and procedures need more emphasis and (2) make sure outgoing official mail containing errors or deficiencies in preparation is returned for correction.
- Review spoiled postage meter tapes and establish procedures to reduce their occurrence and ensure proper disposition has been made of them.
- Analyze the use of postage and use the results to make the command's official mail program more cost-effective.
- Coordinate with supporting supply and procurement activities to ensure postal-related items being procured such as envelopes, cards, and labels meet standards outlined in:
  - USPS regulations
  - The DOD Official Mail Manual, DOD 4525.8-M
  - The Navy Official Mail Management Instructions, OPNAVINST 5218.7
  - Your command's postal Standard Operating Procedures
- Know who their USPS account representative and other appropriate USPS officials are.
- When possible, belong to and attend meetings of the local USPS-sponsored Postal Customer Council (PCC). The OMM should even consider starting a PCC if one does not exist in the area.

*Q13-10. What factor determines which method your command will use for postage (postage stamps or computer-generated postage, or meter machine) for conducting official mailings?*

*Q13-11. What form is used as a daily recap of postage used for official mailings?*

*Q13-12. What form is used to audit postage stamp stock used for official mailings?*

*Q13-13. Commands that desire to use computer-generated postage must obtain a meter license from the USPS. (True or False)*

*Q13-14. Subordinate official mail installations should be inspected at least how often?*

*Q13-15. What form is used for inspecting official mail facilities?*

Now turn to appendix 1 to check your answers.

## CLAIMS AND INQUIRIES

---

**Learning Objective:** *Recall the procedures for processing claims on official mail.*

---

The Government Losses in Shipment Act (Title 40, *United States Code*, Section 726) and the government's general self-insurance policy prohibit federal agencies from using registered and insured mail for the sole or primary purpose of obtaining postal indemnity.

Do not process claims against the USPS for indemnity on official mail items lost or damaged in the mail. The Comptroller General of the United States Decision B-114874, 13 October 1978, allows the government to use registered or insured mail only to obtain the added protection or proof of delivery offered by these special postal services.

Keep in mind the information just discussed. You must remember we can only trace official mail by using a USPS claim or inquiry form. There will be no actual mail claims for lost, damaged, or rifled official mail. A mail tracer can be completed and only used to try and locate missing or rifled official mail or the tracer form may be used to document damage to official mail. The various post offices that may have handled the lost mail should receive the tracer form as an inquiry.

File a tracer immediately when the contents of a package are known to be rifled. For lost official mail, sufficient time must be allowed for the article to be delivered before filing a tracer. There are minimum and maximum time limits applicable to filing tracers for lost mail sent to the United States or APO-FPO addresses (refer to the DMM or POM for these time limits). The missing official mail may have been misrouted or accidentally sent to another address. So allow time for the missing official mail to reach its final destination.

Always use the proper USPS claim (tracer) form(s):

- For lost or rifled insured and registered mail, use PS Form 1000.
- For lost or rifled ordinary and certified mail, use PS Form 1510.
- For Express Mail, use PS Form 1000.

When tracing official mail sent to Canada and other foreign countries a different set of rules apply and different forms must be used. When tracing official mail to foreign countries other than Canada use:

- PS Form 542 for lost ordinary, insured, and registered mail.
- PS Form 2855 for damaged or rifled insured and registered mail.

When tracing official mail sent to Canada use:

- PS Form 542 for lost ordinary and registered mail.
- PS Form 2855 for lost, damaged, or rifled insured mail; and damaged or rifled registered mail.

## PREPARATION AND PROCESSING

---

**Learning Objective:** *Recall the procedures for preparing and processing official mail for dispatch.*

---

The preparation and processing of mail is the first step in the official mail delivery cycle and involves the following:

- Preparation, by the office(s) sending the mail
- Consolidation, by the office(s) sending the mail or the CMF or other mail acceptance site that prepares the mail for dispatch
- Collection, by the post office, CMF, or other mail acceptance site that will prepare the mail for dispatch
- Postmarking, by the post office, CMF, or other mail acceptance site that prepares the mail for dispatch
- Classifying, such as First-Class, Priority, or Standard Mail (B), as decided by the office sending the mail, or the CMF, or other mail

acceptance site that prepares the mail for dispatch

- Sorting, by the post office, CMF, or other mail acceptance site that prepares the mail for dispatch
- Pouching, by the post office, CMF, or other mail acceptance site that prepares the mail for dispatch
- Traying, by the post office, CMF, or other mail acceptance site that prepares the mail for dispatch

## PREPARATION

The USPS reserves the right to refuse improperly prepared mail. Official mail acceptance sites must also return all outgoing official mail to the sender when an address is not formatted correctly. To avoid having the USPS return an article to the sender, personnel who accept articles for mailing must be familiar with USPS requirements. All mail must be prepared according to instructions provided by the USPS in the *Guide To Business Mail Preparation*, USPS Publication 25, the DMM, or the IMM, as appropriate.

The ultimate goal of USPS and the MPS is to speed the delivery of mail. To meet USPS automation requirements, addresses on official mail must be typed or printed in uppercase letters and should not contain any punctuation except for the hyphen in the ZIP + 4 Code. Delivery and return addresses must be limited to five lines and be formatted with a uniform left margin with each line limited to a maximum of 40 characters per line, including spaces; and eight separate words per line.

Inadequate packaging is the most common cause for loss and damage in the mails. Ensure the contents of items being mailed are wrapped and packaged to withstand the mail-handling process, transportation environment, and in a manner that will not cause harm to mail handling personnel, equipment, or other mail. Train all mail handling personnel who prepare articles for mailing to:

- Use inexpensive, lightweight, sturdy cartons or shipping containers capable of protecting the item being mailed.
- Pack items in a stronger outer container when possible.
- Place the address label on top of the package and make sure the label is easy to read and understand.

- Make sure the address label contains complete delivery and return addresses with no punctuation except the hyphen in the ZIP + 4 Codes.
- Provide proper mail classification endorsements, appropriate special service markings, or other important instructions correctly on the address label or address side of the package.

Individual consolidated mail shipments must be packaged in accordance with the requirements in the DMM. Other than First-Class Mail may be combined with First-Class Mail only when cost-effective. Large paper envelopes or cartons may have the address and postage placed on the container or an address label. If a label is used, the postage meter tape or postage stamps must overlap the upper right edge of the label. The words *consolidated mail* or the letters *CM* must be placed immediately below the return address. Consolidated mail containers are to be opened and sorted at the receiving mail center or in the addressee's correspondence distribution center.

## CONSOLIDATION

Consolidation is to combine in one container two or more pieces of mail directed to the same addressee or installation on the same day. That one container is then sent to the addressee as one piece of mail. The container may be a bag, envelope, box, or pouch that will hold two or more pieces of mail. Consolidated mail is a reliable way to ship administrative and operational communications or logistical items between headquarters, depots, contractors, installations, and operational units. The mail remains intact while in transit, which reduces the number of times the contents are sorted. Consolidating mail also reduces the chances of misrouted and delayed mail.

Consolidation reduces costs because postage is paid on the total weight of the consolidated container. Postage is not paid on each separate piece of mail within the container. Under the postage rate structure, the first pound is the most expensive. As weight increases, the cost per pound decreases. The cost and weight of the container and any packaging material must be considered in the mailing cost.

Consolidated mail reduces the number of individual official mailings and thus the Navy's overall postage costs. Consolidated official mailings must be made when they are cost-effective. Some examples of

cost-savings gained through consolidation are as follows:

- Five letters weighing an average of three-fourths of an ounce each are consolidated in a single letter-size envelope. The cost if each is mailed individually (with current postage rates) is \$1.65, but if they were consolidated the cost would be 99 cents.
- Nineteen letters weighing an average of three-fourths of an ounce each are consolidated in one large envelope endorsed Priority. Cost individually is \$6.27 but if consolidated would be \$3.20.

To make the most of consolidation, each command must designate one office to process all outgoing mail. At small commands this can be the command administrative office. Shore commands with large supply departments are authorized to designate two offices for processing outgoing mail. One can be for processing outgoing administrative type of official mailings and the other can be for processing outgoing logistics type of official mailings.

Once control of official mail is established, cost-savings will be realized. Frequently survey outgoing mail to identify those addressees for whom several pieces of mail are normally generated. Set up groups of separate holdout slots, boxes, or bins for those repeat addressees. This will allow a basic structure for consolidating outgoing mail.

At a set time, just before final mail closeout each day, consolidate mail generated for repeat addressees. Consolidate by class of mail into the minimum number of official mailings possible. At large shore activities, or in other areas where several naval commands are located, consider assigning one office to act as single point of consolidation for all outgoing official mail.

The goal of consolidating official mail is to save the Navy resources and money. Most Navy commands consolidate official mail, but there still may be a few areas requiring further attention.

## COLLECTION

Official mail must not be deposited in collection boxes. The senior PC must advise personnel in the command that official mail must be collected from unit mail orderlies or clerks who work in the office that applies postage on the mail.

Deliver official mail found in mail collection boxes to the local OMM for further disposition. The OMM must return the official mail to the office personnel who put the mail in the ordinary mail collection box. The OMM should then decide if office personnel dealing with official mail require further training in official mail procedures.

## POSTMARKING

Official mail bearing postage stamps must be postmarked along with ordinary outgoing mail. Do not postmark mail deposited after the last scheduled collection until the following day. Postmark missent official mail on the back to show the date received before dispatching it to its final destination.

## SORTING

Official mail is sorted, bundled, and dispatched with other outgoing mail. Handle official mail the same as other outgoing ordinary mail, provided the official mail has no registered mail or special services added. As previously discussed, registered mail is handled with more security than ordinary mail.

Incorrect sorting or pouching of mail will result in mail delays. Strict adherence to proper procedures is of utmost importance and will help prevent unnecessary mail delays.

## MAIL CLASSIFICATION

The class of mail service selected for Navy official mail should meet the security, accountability, and delivery requirements of the material being shipped at the lowest possible cost.

Compute the postage and fees for domestic mail according to the DMM. Use USPS Poster 123 with the Postal Zone Chart for the post office to which the item will be mailed. Figure the postage and fees for international mail according to the IMM, and USPS Poster 51. Properly programmed electronic scales may be used to compute postage and fees.

Items mailed from one overseas MPO to another overseas MPO in the same theater must have the words *DOD Official Intra-Theater Mail* placed in the area where the postage is usually affixed. The words *DOD Official Intra-Theater Mail* can be typewritten, rubber stamped, or mechanically printed.

First-Class Mail may be used for mailing the following:

- Official handwritten or typewritten material
- For items required by USPS regulations to be sent at the First-Class rate of postage (refer to Module R of the DMM for weight restrictions)
- Material less periodicals (including newsletters) and newspapers, that cannot be mailed more economically at a lower class or rate of postage

Priority Mail may be used for mailing the following:

- Official handwritten or typewritten material
- Items required by USPS regulations to be sent at the Priority Mail rate of postage (refer to Module R of the DMM for weight restrictions)
- High-priority shipments, such as non-mission capable supplies (NMCS), partially mission capable supplies (PMCS), casualty report (CASREP), ships' essential equipment requisition expediting program mission capable (SEEREP MICAP), 999, or other items critical to flying and marine safety
- Material mailed under the Uniform Material Movement and Issue Priority System (UMMIPS) priority designators 01 through 08 consigned to addressees located more than 300 miles from the sender
- Shipments of supply issue group I or II material consigned to mobile units and overseas activities served by FPO or APO addresses

Official mailings not qualifying as Priority Mail and weighing more than 13 ounces must be endorsed and sent as Standard Mail (B). Standard Mail (B) is matter weighing more than 13 ounces, not mailed or required to be mailed as First-Class Mail, and not mailed at the Periodical rate of postage. Official mailings not required to be mailed First-Class or Priority Mail, and not exceeding 70 pounds or 108 inches in length and girth combined, must be endorsed and sent as Standard Mail (B).

Official mailings having a critical required delivery date, but do not qualify as First-Class or Priority Mail and are destined for addresses outside of the United States (including Alaska and Hawaii) may be sent as military ordinary mail (MOM). In addition to the class of mail endorsement (Standard Mail (B)), this mail must have the abbreviation MOM boldly rubber-stamped or printed on the address side of the mail container.

## **POUCHING, SACKING, OR TRAYING OUTGOING OFFICIAL MAIL**

A pouch is a mailbag identified by the leather strap-locking device on the neck of the pouch. The pouch is commonly used for First-Class Mail, Priority Mail, and Space Available Mail. Use the special blue and orange pouch for Express Mail service.

A sack is a bag used to transport nonpreferential Periodicals and Standard Mail. It is closed with a draw cord and fastener.

A tray is used for flats or letters, depending on the tray dimensions. A flat tray is a four-sided tray, 18 inches by 21 inches by 24 inches inside. A letter tray is 12 or 24 inches long with inside dimensions of 11 inches by 3 1/4 inches.

Outgoing official mail is pouched or trayed just as other outgoing mail. This is the first step in the dispatch of mail. All mail must be pouched, sacked or trayed by classification and service, considering priorities, transportation policies, and cost. All MPOs must use the following general guidelines when pouching or traying outgoing mail:

- Dispatch Priority Mail in large orange Priority Mail pouches, and First-Class letter mail in orange Priority Mail No.1 pouches or in Managed Mail (MM) letter trays.
- Dispatching activities must not commingle First-Class Mail or Priority Mail with other classes of mail.
- Dispatch returned to sender letter mail with other letter mail.
- Items that could possibly damage mailbags or other mail must not be pouched but must be dispatched as outside pieces (OSPs).

Place all mail in pouches or trays, then label and tag them properly. Since slide labels and tags are the only external identifiers of end destinations for mail contained in the pouch or tray, be careful to label all mail correctly before manifesting for transport.

## **SECURITY**

Proper security must be provided for official mail received from pickup to delivery. Handle and treat official registered mail as if it contained Secret material.

All personnel are responsible for preventing the theft, misuse, waste, or loss of postage stamps. Secure postage stamps in locked containers such as safes or file cabinets.

Postage stamps and postage metering equipment must be given the best possible protection against loss or theft. Security of postage stamps and postage metering equipment is the responsibility of all personnel who work in mail centers or at other mail acceptance locations. The OMM must maintain records reflecting the number and cost of stamps requisitioned, used, and remaining on hand. This procedure prevents unauthorized use of postage stamps.

*Q13-16. Claims for indemnity can not be filed on official mail items lost or damaged in the mail. (True or False)*

*Q13-17. What is the first step in the official mail delivery cycle?*

*Q13-18. Official mail should be dispatched separate from ordinary mail. (True or False)*

Now turn to appendix 1 to check your answers.



## CHAPTER 14

# POST OFFICE AUDITS, REPORTS, AND INSPECTIONS

To determine business volume, check accuracy of records and the conduct of employees, private business firms schedule inventories and audits at periodic intervals. By analyzing records of inventories and audits, a corporation can determine whether the business is being operated efficiently and economically. The USPS also requires periodic inspections and audits of military post offices, which serves the same purpose.

Audits, reports, and inspections are management tools designed to ensure correct administrative and operational policies of the Military Postal Service (MPS) are being adhered to. A record and/or a copy of each audit, inspection, or other required report that is prepared becomes a part of the post office files. You must be able to locate information relating to these reports, so you should maintain a neat, orderly file of all reports, official correspondence, requisitions, instructions, and notices, etc.

An audit or inspection of some aspect of your post office operation will be conducted daily, weekly, monthly, quarterly, and yearly (see table 14-1).

In this chapter we will discuss the audits, reports, various inspections, and records required to be completed and maintained at Navy post offices.

### TYPES OF AUDITS

---

**Learning Objective:** *Distinguish between the different types of postal audits.*

---

What is an audit? An audit is an inspection of accounts, including financial entries recorded on reports and records, which are checked for accuracy. The quantity of each denomination of stamps and stamped paper on hand are counted to determine their cash value, money order funds and blank money order forms are verified for correctness, and if applicable postage meter and stamp vending machine accounts are verified. There are three types of official audits that are conducted in an MPO. The types of audits, the degree of frequency when each is performed, who performs the audit, and what is audited are as follows:

- **MONTHLY AUDIT**—An audit conducted on each fixed or flexible credit stamp stock account advanced. The audit is unannounced and is conducted by two or more members of the command monies audit board.

During the monthly audit, all postal effects such as stamp stock, money order and postage meter accounts, and stamp vending machine accounts in custody of an MPC, the COPE, and reserve custodian must be audited. DD Form 2259, Report of Audit of Postal Accounts (for fixed credit accounts) or PS Form 3294, Cash and Stamp Stock Count and Summary (for flexible credit accounts) must be completed on the same day. PS Form 3368, Stamped Credit Examination Record, is used to record the results of all required audits.

- **QUARTERLY AUDIT**—An audit conducted during the third month of each calendar quarter (March, June, September, December). This audit may count as both the monthly and quarterly audit and is conducted by two or more members of the command monies audit board.

Quarterly audits are conducted in the same manner as monthly audits. Audits of all accounts must be completed on the same day using DD Form 2259, PS Form 3293 or PS Form 3294, as applicable for the type of account being audited, and documented on PS Form 3368. Quarterly audit results are required to be submitted to the NPFO San Diego.

- **SPECIAL AUDIT**—An audit conducted at the request of the Commanding Officer, or as required by DOD or DON instructions. One example of a special audit is a CHANGE OF COPE AUDIT. This audit transfers the responsibility for accountable items from the outgoing COPE to the incoming COPE. The incoming and outgoing COPE and two or more members of the monies audit board must conduct this audit.

There are other reasons when a special audit would be required; such as when a postal clerk has been hospitalized, is missing, or absent without leave (AWOL). Special audits are also required during postal investigations when funds are missing.

**Table 14-1.—Record of Audits, Reports and Inspections of Military Post Offices.**

<b>RECORD OF INSPECTIONS AND REPORTS</b>			
<b>FREQUENCY</b>	<b>AUDIT, INSPECTION, OR REPORT</b>	<b>FORM USED</b>	<b>INSPECTED BY</b>
DAILY	VERIFICATION OF MONEY ORDER BUSINESS  VERIFICATION OF POSTAGE METER BUSINESS	PS 6019 DD 885  PS 3602-PO	COPE OR DESIGNATED VERIFYING OFFICIAL
WEEKLY	POSTAL OFFICER'S WEEKLY INSPECTION	NAVSUP FORM 5119	POSTAL OFFICER
* MONTHLY	AUDIT OF STAMP, POSTAGE METER, MONEY ORDER, AND STAMP VENDING MACHINE ACCOUNTS	DD 2259 PS 3293 PS 3294 PS 3368	MONIES AUDIT BOARD MEMBERS
USPS FOUR WEEK ACCOUNTING PERIOD	VENDING EQUIPMENT SALES AND SERVICES REPORT (VESS)	PS 8130	COPE
* QUARTERLY	AUDIT OF STAMP, POSTAGE METER, MONEY ORDER, AND STAMP VENDING MACHINE ACCOUNTS  POSTAL ACTIVITY REPORTING SYSTEM (PARS) REPORT	DD 2259 PS 3293 PS 3294 PS 3368  MESSAGE	MONIES AUDIT BOARD  COPE
ANNUALLY	POSTAL ASSESSMENT (SHORE ACTIVITIES)	POSTAL ASSESSMENT GUIDE	POSTAL ADVISOR
EVERY 18 MONTHS	POSTAL ASSESSMENT (SHIPS)		
* SPECIAL	CHANGE OF COPE  CHANGE OF COMMAND  COMMAND INSPECTION	DD 2259 PS 3293 PS 3294 PS 3368  DD 2259 PS 3293 PS 3294 PS 3368  POSTAL ASSESSMENT GUIDE	COPE/MONIES AUDIT BOARD MEMBERS  MONIES AUDIT BOARD  POSTAL ADVISOR

**\* DD Form 2259 is used to audit fixed credit accounts, PS Form 3293 is used to audit stamp vending machine accounts, and PS From 3294 is used to audit flexible credit accounts.**

Special audits may count as monthly or quarterly audits.

Fixed or flexible credit accounts as stated above are officially audited on a monthly and quarterly basis, and at any time required for special reasons. All audits must be documented and closely reviewed to determine the ability of individuals to manage the portion of the command's credit assigned to them.

## **REPORTS, INSPECTIONS, AND ASSESSMENTS**

---

**Learning Objective:** *Recall and understand the different reports, inspections, and assessments required at MPOs.*

---

In this section we will cover the frequency of submission of required reports of MPO accounts, and the frequency of inspections and assessments that are performed at military post offices.

### **DAILY REPORTS**

Two types of accounts are required to be audited and reported daily if you have a fixed credit. They are money order accounts and postage meter accounts. These accounts are inspected, audited, and reported by the COPE or a command designated representative (usually the disbursing officer).

When verifying money order accounts, PS Form 6019, Military Post Office Report of Money Order Business, must be completed and verified for accuracy. The clerk who sold the money orders is responsible for preparing the report and submitting the remittance via registered U. S. mail or Express Mail (overseas activities). If the money order account is short any amount of funds, the responsible clerk must replace the shortage.

When verifying the postage meter account(s) PS Form 3602-PO, Postage Collected Through Post Office Meter, must be completed and verified for accuracy. The COPE is responsible for preparing the report and submitting the remittance via registered mail. Like the money order account, if a shortage exists, the responsible clerk must replace the shortage.

When working with a flexible credit account, the COPE will verify the accuracy of the clerk's account using a computer-generated PS Form 1412-B detailing the business conducted by the finance clerk. This printout lists money orders sold and cashed, checks

received, Postage Validation Imprinter (PVI) readings, and the amount of currency the clerk should return to the COPE upon completion of that day's business. For flexible credit accounts, clerks do NOT complete a PS Form 6019 or PS Form 3602-PO and money orders should be retained until they are all used.

### **WEEKLY INSPECTIONS**

The postal officer must inspect the post office spaces on a weekly basis using the Postal Officer's Weekly Inspection Checklist (see figure 14-1). The postal officer should also note equipment condition and related safety hazards. Safety hazards must be corrected at once. General appearance of the postal spaces should be noted also. When the post office is neat and orderly, it sets a good example for others. Properly stowed items must also be looked at. You should always keep your post office inspection ready.

### **USPS FOUR-WEEK ACCOUNTING PERIOD REPORT**

USPS has 13 numbered four-week accounting periods (APs) each year. Each AP begins on a Saturday and ends at close of business on a Friday four weeks later. The 13-period calendar for each Postal FY is published every September in the Postal Bulletin.

During each four-week USPS accounting period, the COPE or MPC at commands with stamp vending machines must complete a PS Form 8130, Vending Equipment Sales and Service Log reporting vending equipment serviced and maintained during the accounting period.

Completion of this report is covered later in this chapter.

### **QUARTERLY POSTAL ACTIVITY REPORTING SYSTEM (PARS) REPORT**

The Postal Activity Reporting System (PARS) report is submitted by the COPE at the end of each quarter. This report should be routed through the chain of command before submission to the appropriate FLTCINC. The PARS report is discussed in detail later in this chapter.

### **ANNUAL AND SEMI-ANNUAL POSTAL ASSESSMENTS**

Postal Assessments must be conducted annually for overseas shore-based post offices, and semi-annually for shipboard post offices. Postal assessments are covered later in this chapter.

**POSTAL OFFICER'S WEEKLY INSPECTION CHECKLIST**

REFERENCE	POSTAL FINANCE		
DOD Vol I (502.3.b.2)	a. Does the Postal Clerk's, Reserve Custodian's or Custodian of Postal Effects (COPE's) current cash on hand exceed 25% of his/her total fixed credit at the time of the inspection?		
DOD Vol I (502.5.b. (1))	b. Verify that the postal clerk is requisitioning stamps from the reserve custodian or COPE before reaching maximum 25% cash allowance, at shore based post offices and deployed ships.		
OPNAVINST 5112.6C (Chap 1, para 104.2.h)	c. Are scales calibrated (annually) for accuracy?		
<b>SECURITY</b>			
DOD Vol I (504.2, 504.3)	a. Inspect all post office drawers and safes to ensure that unauthorized personal property or fund is not stowed in safes. Insure safe combinations are changed annually, registered mail is properly secured, and for post office that has an alarm system installed, are they operatable?		
DOD Vol I (906.1.i)	b. Has each division picked-up mail at the last mail call and is the mail given only to authorized mail orderlies? (Check at least 10% of the divisions)		
<b>DIRECTORY SERVICE</b>			
DOD Vol II (605)	a. Is all undeliverable mail being held endorsed on the reverse side of the article showing date received? (Determine the reason the mail is being held)		
DOD Vol II (605)	b. Is undeliverable mail given prompt directory service and disposition made by the next business day?		
<b>REGISTERED MAIL</b>			
DOD Vol I (801)	a. Is registered mail on hand in the post office under constant surveillance or secured properly at all times?		
DOD Vol I (802.5.h and 802.5.i)	b. At the close of each business day or at each shift change, is the "Registered Mail-Balance and Inventory Sheet" (DD Form 2261) being prepared properly, reviewed and signed by a witness?		
DOD Vol I (802.5.k.(1))	c. Is incoming and outgoing registered mail being dispatched and signed for on the correct PS/OPNAV Forms?		
<b>MODIS/WINSALTS</b>			
NAVSUP MSG DTG 14 1400Z DEC 99	a. For deployed ships, forward deployed ships and overseas shore based post offices, is incoming Express Mail (pouches and outside pieces), First Class Mail (trays and pouches), and Priority Mail (pouches and outside pieces) being scanned, and is scanned data being transmitted via WINSALTS daily?		
<b>GENERAL</b>			
DOD Vol I (906.1.e)	a. Ensure that the post office is clean and neat in appearance and no personal effects or funds are being stored in the post office.		
DOD Vol II (605.d)	b. Inspect the trash to ensure mail is not being wrongfully discarded (other than undeliverable bulk rate mail).		
DOD Vol I (906)	c. Have claims and inquiries received since the last weekly inspection been processed properly?		
DOD Vol I (Part II, 310)	d. Are Postal Activity Reporting System (PARS) and Vending Equipment Sales and Services (VESS) reports prepared and submitted as required?		
USPS Postal Bulletin	e. Are the latest changes received in USPS Postal Bulletins posted to the International Mail Manual (IMM), Domestic Mail Manual (DMM), and are the APO/FPO changes and listing of stolen money orders posted at the finance windows?		
DOD Supply Catalog (109)	f. Are sufficient postal forms and supplies on hand to effectively operate a post office?		
	g. Have discrepancies noted on the last weekly inspection been corrected? (If not explain why in the remarks).		

Remarks: \_\_\_\_\_

Submitted: \_\_\_\_\_ Date of Inspection: \_\_\_\_\_  
 (Postal Officer)

Reviewed: \_\_\_\_\_ Date Reviewed: \_\_\_\_\_  
 (Supply Officer)

NAVSUP Form 5119 (6-00)

PCF1401

**Figure 14-1.—An example of a Postal Officer's Weekly Inspection Checklist.**

## AUDITING FIXED AND FLEXIBLE CREDIT ACCOUNTS

---

**Learning Objective:** *Recall the procedures for conducting postal audits.*

---

Stamps and postal stationery are issued by a PFO to MPOs in the form of fixed credit, or by Postmaster, New York or Postmaster, San Francisco as flexible credit.

Fixed credit is a fixed amount of monetary credit extended to a COPE or other postal clerks for conducting financial services and for ordering stamps and stamped paper from the USPS.

Flexible credit is an initial amount of credit extended to a COPE or PFO by the U.S. Postal Service for ordering accountable paper. A stamp sales remittance reduces the amount of credit, while stamp requisitions increase the credit.

The total amount of fixed or flexible credit carried by an MPO depends upon the estimated number of persons to be served. As a general guide, this amount is calculated at a minimum of \$25 per person with a minimum amount of \$5,000 for the command's credit. For fixed credit accounts, the COPE only keeps enough of the fixed credit to conduct day-to-day operations. The rest is held by a reserve custodian and receipted for on a Consigned Credit Receipt, PS Form 3369. The COPE keeps the original of the PS Form 3369 and the reserve custodian is given a duplicate copy. As stamps are sold, the cash from stamp sales becomes part of the fixed credit. To replenish stamp stock, the COPE must submit a stamp requisition once the cash on hand reaches 25% of the fixed credit. The amount of stamp stock on hand added to the amount of cash on hand and requisitions in transit should always equal the total amount of the command's fixed credit.

When new stamp stock is ordered for a fixed credit account, funds are remitted by check to the PFO or NPFO. Upon receipt, the stamps become a part of the fixed credit. As the COPE, you must always be able to produce the full amount of the credit in stamp stock, in-transit stamp requisitions, and funds during audits.

The flexible accounting system provides more latitude in stamp requisitioning as funds are not submitted with requisitions to obtain stamps and stamped paper. A PFO or COPE's accountability for stamps and stamped paper under this system is reduced, based on stamp sales remittances, and increased when stamp requisitions are received.

Therefore, the term "FLEXIBLE" rather than "FIXED" is used to identify this system of accountability.

Official audits of an MPC's account are made by the monies audit board members. However, accounts used to conduct window sales may also be audited at any time by the COPE or postal officer.

To conduct a proper inspection and audit, auditors must be familiar with the *DOD Postal Manual*, Volume I, as well as portions of the U.S. Navy Postal Instruction (OPNAVINST 5112.6).

By making these instructions available and by assisting in every way possible, you will be ensuring an accurate inspection.

### TOLERANCE LIMITS

Once the audit is completed, and all figures are totaled and verified, there is a chance that the account may be over or short of the credit amount. Tolerance limits have been established for this purpose. Tolerance limits apply only to credits of finance clerks conducting window transactions with customers.

Tolerance limits for fixed credit accounts, plus or minus, are as follows:

- \$300.00 or less—\$2.00
- \$300.01 - \$1000.00—\$10.00
- \$1000.01 - \$5000.00—\$20.00
- \$5000.01 and above—\$40.00
- Stamp vending accounts—\$20.00

Tolerance limits for flexible credit accounts are 1% of the flexible credit.

Fixed and flexible credits being withdrawn have no tolerance levels.

### AUDIT RESULTS

Overages and shortages within tolerance limits are carried forward to the next audit. The disposition of overages and shortages in excess of the tolerance limits is as follows:

- The entire amount of an overage, to include the tolerance, is collected by the auditor and turned over to the COPE. The COPE will prepare a PS Form 1096, Cash Receipt, in duplicate. The clerk receives the original and the COPE retains the duplicate copy in the MPO files. For a fixed

credit account, the COPE remits overages to the NPFO by check along with a copy of the audit. For flexible credit accounts, the COPE provides the clerk with a PS Form 1096, then adjusts the clerks account using the “trust” function of the account.

- Shortages, to include the amount of tolerance, are replaced by the postal finance clerk at the time of the audit. The COPE will provide the clerk with a receipt for the amount. With flexible accounts, an additional procedure is required by the COPE, the restitution will be documented using the “suspense” function.
- Under certain circumstances, an overage in one clerk’s credit may offset a shortage in another clerk’s credit. The transfer of funds will be documented using PS Form 1096, prepared and signed by the receiving clerk, and provided as a receipt to the clerk relinquishing the funds. This can only be done when the auditor has proof the two clerks exchanged money or stamp stock.
- During audits, individual credit accounts do not require re-auditing when a shortage or overage exists within tolerance limits. Carry these differences forward to the next audit. However, if the individual being audited requests a re-audit, the auditor shall comply. If the re-audit agrees with the original audit no further audits are required.

## **PREPARING DD FORM 2259 FOR FIXED CREDITS**

When conducting an audit, the auditor completes DD Form 2259, Report of Audit of Postal Accounts (see figure 14-2 and 14-3). A separate DD Form 2259 will be completed for each account audited. The auditor completes DD Form 2259 (front side) as follows:

Block 1: Enters the unit’s address.

Block 2: Checks the appropriate box for the type of audit being conducted.

Block 3: Enters the time and date of the audit (six-digit YR, MO, DAY).

Block 4: Enters the name (last, first, middle initial) and paygrade of the person being audited and of the auditor.

Block 5: Enters the total amount that the person being audited is accountable for as listed in the credit amount block of PS Form 3369.

Block 6: Completes this section after counting the entire fixed credit. The blocks correspond to the results on the back of the form. If applicable, the auditor checks the overage/shortage block according to the audit results and lists the amount of overage or shortage next to the dollar sign.

Block 7: The money order account section must always be checked and if money orders are in the custody of the clerk being audited, the serial numbers (first and last) must be recorded. Money orders must be individually checked to ensure all blank money order forms are accounted for.

Block 8: If a postage meter is in the custody of the clerk being audited, the auditor verifies the beginning and ending ascending and descending numbers (records in the remarks section), indicates ending amount, and ensures the funds are accounted for.

Block 9: Completes the remarks section with information given in special instructions (refer to the NPFO Handbook chapter 3).

Block 10: The signature of the individual being audited and of the two auditors must be in this block.

The auditor completes DD Form 2259 (reverse side) as follows:

Block 1: Lists the quantity, denomination, and value of all stamps in the stamp stock of the clerk being counted.

Block 2: Lists the quantity, denomination, and value of all cash counted.

Block 3: If a stamp requisition (PS Form 17) has been submitted and not received, then the auditor indicates the requisition number, date dispatched, check number, and the value of the requisition as shown on the file copy of PS Form 17.

## **Auditing Money Order Accounts**

A postal clerk conducting window transactions may be selling money orders. An audit of funds from these sales must also be conducted. This is done by totaling the amount shown on the money order vouchers and the amount of fees charged, then subtracting paid money orders, if any. The clerk must make up any shortage in the money order fund and any overages must be collected using PS Form 1096. Tolerance limits do not apply. The required data is recorded on DD Form 2259 by the auditors.

Auditors will also verify money order reports to ensure that money order serial numbers are in sequence from one report to the next, that spoiled money order







serial numbers are accounted for, that cashed money order serial numbers do not repeat from one report to another, and that registered dispatch numbers match those that are annotated on the attached PS Form 3806, Receipt for Registered Mail. At overseas commands that send money order reports by Express Mail, the auditor must check the Express Mail number on the post office copy of PS Form 6019 against the copy of the USPS Label 11-B attached to the report.

### **Auditing Postage Meter Accounts**

In some instances window clerks may also use a postage meter, in addition to a fixed credit, to conduct window transactions. The funds must be separated before auditing the fixed credit portion. The amount of funds generated from use of a postage meter is determined by subtracting the current ascending and descending readings shown on the postage meter from those shown on the clerk's copy of PS Form 3602-PO. The funds are then withdrawn from the clerk's fixed credit and set aside until the audit is completed. Once verified the auditors will record the amount in the Postage Meter Account section on DD Form 2259.

### **Verification of PS Form 1590**

When the auditors have completed their count of the entire fixed credit for the MPO, a verification should be conducted of all capital equipment assigned to the MPO which was receipted for on PS Form 1590, Supplies and Equipment Receipt. All items listed on PS Form 1590 should be sited. Any missing items will be reported as a postal offense or loss as outlined in the *DOD Postal Manual*, Volume 1.

### **AUDITING STAMP VENDING MACHINES (SVM)**

Audits of all SVMs will be conducted during the monthly audit using PS Form 3293, Retail Vending Credit Examination (see figures 14-4 and 14-5), and the results recorded on PS Form 3368, Stamp Credit Examination Record. A separate form will be used for each SVM account. The serial number of the SVM audited must be entered in the "Remarks" section of PS Form 3293. All SVMs have a tolerance of \$20.00.

For fixed credit accounts any overages discovered at the time of the audit shall be held for a period of 3 days before remitting to the NPFO San Diego. This procedure allows the customers, who may be due a refund, the time necessary to request reimbursement. If a refund is made to a customer, PS Form 3293 is

annotated in the "Remarks" section and a correction made to the overage amount. The following procedures for processing overages and shortages are specific to fixed credit accounts:

- Overages. COPE's will submit all overages to NPFO San Diego, who in turn will submit it with PS Form 1412-B, Daily Financial Report to Postmaster, San Francisco. Overages will be submitted with a letter listing the location of and name of person responsible for the SVM and name of auditor if overage was discovered during a monthly or quarterly audit.
- Shortages. The COPE will submit a letter of explanation for shortages to include the amount; name of individual who filled the SVM; serial number, and location of the SVM. The letter will be signed by the COPE and Auditor of the SVM.
  - The COPE must send the letter to NPFO San Diego with a completed PS Form 17, listing replacement stock equal to the shortage. The return stamp portion of the PS Form 17 will note the shortage letter as a reference and the amount of the shortage. NPFO San Diego will use the PS Form 17 to forward stock to replace the SVM shortage.
  - The COPE may use this method for the loss of funds due to foreign coins. Send all foreign coins by registered mail along with a list indicating location of the SVM and value of coin(s) (take credit of only up to the amount required to balance the fixed credit of the SVM).

To process overages to Postmaster, San Francisco, NPFO San Diego will complete the following:

- Submit overages on PS Form 1412-B using AIC 175, Vending Machine Overages, as a separate entry in the receipt section. A letter of explanation for the overage will be attached to PS Form 1412-B.
  - Any SVM that has an overage in two consecutive audits must be taken out of service and a replacement module requested. The counter system on the modules records the current number each time the SVM is filled. This enables you to determine how many books were issued, how many are remaining, and the amount of cash received during the audit. Caution should be taken when filling the SVM to ensure that stamp

booklets are criss-crossed to avoid having an extra stamp booklet dispensed in error.

To process shortages to Postmaster, San Francisco, NPFO San Diego will complete the following:

- Report shortages of up to \$49.99 in the disbursement section of PS Form 1412-B using AIC 621, Vending Machine Shortage. This will be added into the cash remitted and reduces accountability.
- Submit a letter of explanation for the shortage submitted by the COPE.
- Submit any foreign coins for refund to the Postmaster, San Francisco.
- Request refunds for shortages of \$50 or more in the disbursement section of PS Form 1412-B using AIC 761, Vending Machine Shortages. A letter of explanation will be attached to the PS Form 1412-B.

For post offices with Flexible Credit accounts using UNISYS III computers, the following procedures apply:

- Accountability of the Vending Machine must be assigned to a Clerk's Disk.
  - If an overage exists, the Clerk's Disk for vending machine is used and the amount of the overage recorded in AIC 175, Vending Machine Overage. The IRT will record the total cash required in AIC 752. This will bring the vending machine account back into balance, and no further adjustment is necessary. The Clerk's Disk for vending machine is consolidated along with all other clerk disks during the normal daily close out.
  - If a shortage of \$20 or less exists the Clerk's Disk for vending machine is used, and the amount of the shortage recorded in AIC 621 (shortages less than \$20). The amount of the shortage is then entered in AIC 096 Stamp Vending Sales. This will bring the vending machine account back in balance and no further adjustment is necessary.
  - If the shortage is over \$20, the shortage is recorded on the Clerk's Disk in AIC 767. AIC 767 will automatically record an increase to postage sales, which will bring the vending machine accountability back into balance. This will generate a FAM. To clear the FAM there are two options:

- Option 1 - If the clerk is held financially responsible for the shortage, the money paid by the clerk is recorded in AIC 367 on the any clerk disk. Recording the payment on a clerk's disk will generate a receipt for the employee.
- Option 2 - If the clerk is not held financially responsible for the shortage, the COPE must submit in writing a request for a "Claim for Loss" to USPS Accounting Services. The request must include a statement from the clerk as to why he or she should not be held liable for the loss, a statement from the COPE attesting that the clerk performed his or her duties properly and a copy of the count sheet. Reasons that are acceptable are theft from the machine that the clerk had no control over, a malfunction, i.e., jackpotting, or excessive customer claims. Claims for Loss (refer to USPS HBK F-1 section 84).

## **PREPARING PS FORM 3294 FOR FLEXIBLE CREDIT ACCOUNTS**

When conducting a flexible credit audit, the auditor completes PS Form 3294, Cash and Stamp Stock Count and Summary (see figures 14-6 through 14-9). A separate PS Form 3294 will be completed for each account audited. Complete PS Form 3294 as follows:

### Heading

Step 1. Type of Accountability: (MPC's will check Stamp Credit and COPE's and PFO's will check Main or Reserve Stock).

Step 2. Name of Employee, Clerk ID No., Unit Name, Unit ID No., and Date of Examination.

### Cash and Cash Items on Hand

Step 1. Count each type of currency (\$100, \$50, etc.) and enter the number in the quantity column. Multiply the quantities by the denominations and enter the results in the amount column. Total the amount column and enter the result in line 26, total cash.

Step 2. Enter the total amount of government checks to line 28, paid money orders to line 29, travelers checks to line 30, and credit/debit/PPC card receipts to line 31.

Step 3. Total lines 27 through 32 and enter the result to line 33, Total Cash and Cash Items on Hand and place in line 1, column II, Total Cash and Cash Items on Hand.



## Retail Vending Credit Examination

Post Office Name FLEET MAIL CENTER SIGONELLA	Servicing Person's Name <i>(Type or Print)</i> ABLE B. SEAMAN	Today's Date 18 DEC00
Equipment Location FPO AE 09627	Examiner's Name <i>(Type or Print)</i> JOHN R. DOE	Exam Date 18 DEC00

**Stamp Vending Machine, Booklet Vending Machine or Booklet-Stamp Vending Machine**

Line		__Coil	__Coil	__Coil	__Coil	__Coil	__Coil	__Coil	__Coil	Total
1	Present Counter Reading									Add All Line 8 Entries Horizontally & Place Total Amount Here ▼
2	Counter Reading When Coil Was Inserted									
3	Stamps Dispensed <i>(Line 1 minus line 2)</i>									
4	Value of One Stamp	\$	S	\$	S	\$	S	\$	S	
5	Value of Stamps Dispensed <i>(Line 3 times line 4)</i>	\$	S	\$	S	\$	S	\$	S	
6	Initial Value of Coil	\$	S	\$	S	\$	S	\$	S	
7	Value of Stamps Dispensed <i>(From line 5)</i>	\$	S	\$	S	\$	S	\$	S	
8	Value of Stamps Left in Coil <i>(Line 6 minus line 7)</i>	\$	S	\$	S	\$	S	\$	S	
9	Selection No. 1                      Booklets @ \$ <i>(Booklet price)</i>									
10	Selection No. 2                      Booklets @ \$ <i>(Booklet price)</i>									
11	Selection No. 3                      Booklets @ \$ <i>(Booklet price)</i>									
12	Selection No. 4                      Booklets @ \$ <i>(Booklet price)</i>									
13	Total Value of Loose Stamps in Vending Machine									
14	Total Value of Coin Mechanism Coins									
15	Total Value of Coins in Hoppers (#1) \$ _____ + (#2) \$ _____ + (#3) \$ _____ + (#4) \$ _____									
16	Total Value of Coin Box									
17	Total Value of Bills in Machine									
18	Total Value of Display Items <i>(If actual sample)</i>									
19	<b>Vending Machine Total</b> <i>(Add lines 8 through 18)</i> →									

**Small Currency Changer**

20	Total Value of All Coins in Coin Hopper	
21	Total Value of Coins in Coin Escrow Buckets	
22	Total Value of Bills in Machine	
23	<b>Small Currency Changer Total</b> <i>(Add lines 20 through 22)</i> →	

Servicing Person's Signature	Examiner's Signature
------------------------------	----------------------

Remarks

HOSPITAL SVM

Figure 14-4.—An example of a completed PS Form 3293 (Front).

**Postal Commodity Machine**

Line	Spiral Number	Item Description	Unit Price	Quantity	A Spiral Total	Spiral Number	Item Description	Unit Price	Quantity	B Spiral Total	Spiral Number	Item Description	Unit Price	Quantity	C Spiral Total
24	1F	PRIORITY	3.20	75	240.00	4C					7R				
25	1R	EXPRESS	11.75	10	117.50	4R	COIL	33.00	8	264.00	8F				
26	2F					5F					8R				
27	2C	BOOK	2.00	25	50.00	5C	BOOK	4.95	25	123.75	9F	POST CARD	.21	85	17.85
28	2R					5R					9R	ENVELOPE	.40	100	40.00
29	3F					6F					10F				
30	3C					6C	BOOK	6.60	15	99.00	10R	ENVELOPE	.40	100	40.00
31	3R					6R									
32	4F					7F									
33	Subtotal of Column A				407.50	Subtotal of Column B				486.75	Subtotal of Column C				97.85

34	<b>Postal Commodity Machine Subtotal (Add the subtotals from line 33)</b>														992.10
35	Total Value of Coin Mechanism Coins														0
36	Total Value of Coin Box														0
37	Total Value of Bills in Machine														0
38	Total Value of Display Items (If actual sample)														0
39	<b>Postal Commodity Machine Total (Add lines 34 through line 38)</b>														992.10

**Vending Stock Reserve**

e 40	Total Value of Reserve Coin Stock	0	49	182	5¢ Coins x \$0.05	9.10
41	Total Value of Reserve Booklet Stock	688.05	50	405	10¢ Coins x \$0.10	40.50
42	Total Value of Reserve Envelope Stock	148.00	51	410	25¢ Coins x \$0.25	102.50
43	Total Value of Reserve Postal Card Stock	0	52	12	\$1.00 Coins/Bills x \$1.00	12.00
44	Total Value of Reserve Commemorative Stock	0	53	2	\$5.00 Bills x \$5.00	10.00
45	Total Value of Other Stamp Stock	0	54	0	\$10.00 Bills x \$10.00	0
46	Total Value of Nonsalable Stock	0	55	0	\$20.00 Bills x \$20.00	0
47	1¢ Coins x \$0.01	0	56	Bogus and Damaged Monies		0
48	Subtotal, Lines 40 through 47	836.05	57	Subtotal, Lines 49 through 56		174.10

58	<b>Vending Stock Reserve Total (Add lines 48 and 57)</b>					1,010.15
----	--	--	--	--	--	----------

**Examination Recap**

59	<b>Subtotal (Add lines 19, 23, 39, and 58)</b>					2,002.25
----	--	--	--	--	--	----------

<p>NOTE: Complete lines 60 through 65 if:</p> <p>a. this is the only form used in this examination, or;</p> <p>b. this is the final page of a multipage examination.</p>	60	<b>Subtotal from Other Forms 3293 (Add all lines 59)</b>				0
	61	<b>Grand Subtotal (Add lines 59 and 60)</b>				2,002.25
	62	<b>Total Value of Unresolved Complaints</b>				0
	63	<b>Grand Total (Lines 61 minus line 62)</b>				2,002.25
	64	<b>Accountability (From Form 1412-A, AICs 853 and 753)</b>				2,001.25
	65	<b>Overage/Shortage (Diff. between lines 63 and 64)</b>				+ 1.00

Servicing Person's Signature <i>Able B. Seaman, PC2(SW)</i>	Examiner's Signature <i>John R Doe, PCC(SW)</i>
--	--

Figure 14-5.—An example of a completed PS Form 3293 (Reverse).

#### Add Back Paid Out Items (Disbursements)

Step 1. Enter any cash paid out shown by receipts in lines 2 through 5, column I. Total them and enter the result in line 5, column II. Add lines 1 and 5, column II. Enter the result in line 6, column II, "Cash That was Available Before Paid Outs."

#### Less Cash Represented by Accountability Items Other Than Stamp Stock (Receipts)

Step 1. Enter total amount of money order vouchers to line 7, total amount of COD Tags to line 9, total amount of Customer Meters (PS Forms 3603's) to line 10, total amount of Post Office meters/PVI, (PS Form 3602-PO and current reading) to line 11, total amount of Retail Packaging Products to line 13. Total lines 7 through 16, column I. Enter the result to line 16, column II. Subtract line 16, column II from line 6, column II, and enter the result in line 17, column II. This amount may exceed the maximum authorized cash portion of the clerk's stamp credit as a result of stamp sales.

#### Stamp Count

Step 1. Count each item of stock and enter the number in the appropriate block on pages 2 and 3 (figures 14-7 and 14-8).

Step 2. Multiply the total number of each item by its face value.

Step 3. Count and multiply redeemed stock consisting of stamped cards, stamped envelopes, aerogrammes, and U.S. international reply coupons by the applicable redemption rate. Enter the results to the appropriate block, by type and total the amount.

Step 4. Total all blocks on pages 2 and 3 of PS Form 3294 and enter the results of the stamp stock counted on line 18, column I.

Step 5. Enter amount from PS Form 17, showing stock in transit from the COPE, to the PFO/NPFO to line 20, column I. Verify the validity of PS Form 17 with the source of stock.

Step 6. Total lines 18 through 20, column I, and enter on line 20, column II.

#### Total Cash and Stamp Stock

Step 1. Add lines 17 and 20, column II, and enter the Total Cash and Stamp Stock on line 21, column II.

Step 2. Enter the Opening Balance Stamps, AIC 840, or Cash Retained, AIC 353 to line 22, column II.

Step 3. Subtract line 22 from line 21, column II and enter the difference to line 23, column II.

Step 4. Enter the Amount of Tolerance for this Credit on line 24. Tolerance should be 1% of the amount listed on the last PS Form 1412-B.

Step 5. If the amount of difference exceeds the tolerance and the parties involved cannot agree with the count, recount the stamp credit account at the request of the clerk. After you have established the amount of overage or shortage, bring the stamp account into balance.

- If there is a shortage, report it in "Suspense Adjustment" to the column marked action taken on line 25.
- For an overage amount exceeding the tolerance, report it in the "Trust" to the column marked action taken on line 25.

Step 6. Darken block lower right-hand corner. Enter the date and amount of credit listed on the previous PS Form 1412-B.

#### Inventory of Employee's Credit Containers (Annually)

Step 1. The COPE or Finance Supervisor usually manages information contained on page 4 (see figure 14-9).

Step 2. The auditor shall inventory all cash drawers, stamp cabinets, safe compartments, envelope drawers, and capital/sensitive equipment listed on PS Form 1590, Supplies and Equipment Receipt.

#### Summary of Main/Reserve Stock Accountability

Step 1. Enter the total of stamp stock from pages 2 and 3 to page 4 under Summary of Main/Reserve Stock Accountability. For a COPE or PFO account, indicate whether PS Form 3295 was correct or has been corrected. If applicable, enter Stamp Stock per PS Form 3958. Enter the difference, whether over or short, and the action taken.

#### Verification of Accountable Forms

Step 1. From the office file of the last PS Form 1412-B submitted by the COPE, record the last numbered receipt issued from PS Form 1538, 3210, 3544, 3582-C, 3602-PO, and 3603 from the receipt controls section.

#### Verification of Money Orders

Step 1. Inspect blank domestic money orders to ensure they are being sold in sequence.

#### Verification of PS Forms 3977 (Semi-Annually)

Step 1. Verify PS Form 3977, Duplicate Key Envelope. For COPE's and PFO's, ensure signatures are current and envelopes are sealed and postmarked.

## Verification of other items (List)

Step 1. List any other items that need to be verified.

Step 2. Ensure clerks and auditors sign and date PS Form 3294.

### DISPOSITION OF DD FORM 2259 OR PS FORM 3294

Submission of each monthly audit is not required, except for the monthly audit held in the last month of each calendar quarter. This audit should be submitted by USPS indicia mail to the PFO or NPFO as applicable. In the Remarks section of the COPE's audit or on a separate sheet of paper with the name of the command and the date of the audit, provide the following information:

- Date of last postal assessment
- Postal Officer's name, rank, and date of designation
- COPE's name, rank, and date of designation
- List all postal clerks assigned and designated on DD Form 2257. If the clerk has a fixed credit assigned, indicate the results of all monthly audits conducted during the quarter; i.e., position, name, rate, date, credit assigned, stamps/cash on hand, resulting overage/shortage. If a clerk holds no fixed credit, list their name, followed by the phrase—"Holds no Fixed Credit." Include names of Non-PC alternates if applicable.
- List all stamp requisitions originated during the quarter. Include date dispatched, requisition serial number, which PFO requisition was sent to, dollar value, and date received.
- Date of COPE's safe combination change.
- Audit overages in excess of tolerance (if any). List check number, if none, omit this paragraph.

When a change of COPE occurs, PS Forms 1590 and 3369 are submitted with a copy of the audit, to the NPFO or PFO for fixed credit accounts, and to the appropriate postmaster for flexible credit accounts.

### RECORDING AUDIT RESULTS

The COPE, postal officer, or MPO supervisor is required to maintain a PS Form 3368, Stamp Credit Examination Record, for each postal clerk that possesses an extended fixed or flexible credit account (see figure 14-10). Also, one of these forms will be maintained for the COPE's account. The PS Form 3368 will be maintained on the individual account until

the account is terminated. Each time a fixed or flexible credit account is audited, the PS Form 3368 will be updated to record the results of the audit.

*Q14-1. What is the best way to determine whether your MPO is being operated efficiently, economically, and in compliance with correct administrative and operational policies?*

*Q14-2. Audits and inspections are considered as being management tools. (True/False)*

*Q14-3. What are the three types of official audits conducted at military post offices?*

*Q14-4. What individual is required to inspect your post office on a weekly basis?*

*Q14-5. To what two publications should you refer the auditors to help them become more familiar with current instructions concerning postal audits and inspections?*

*Q14-6. Explain what tolerance level means in relation to a fixed credit account holder of \$500.*

*Q14-7. Audits of stamp vending machines are conducted at what time?*

*Q14-8. What document is used for auditing flexible credit accounts?*

Now turn to appendix 1 to check your answers.

### MILITARY INSPECTIONS

---

**Learning Objective:** *Recall the types of military inspections post offices can expect and the types of reports required after the inspection.*

---

Military postal clerks must never forget that the post office is part of the command and, as such, the space is expected to be maintained in accordance with the policy set forth by individual commanding officers. A post office, like any other office, cannot operate smoothly and efficiently unless time is devoted regularly to maintaining order, neatness, and cleanliness. To ensure that you do this, the postal officer is required to inspect your post office each week. This inspection includes such areas as the cleanliness and security of the office, a check of undeliverable mail on hand, and the number of empty mailbags on hand. This is a command function documented on NAVSUP Form 5119 and no report is

## Cash and Stamp Stock Count and Summary

Type of Accountability		<input type="checkbox"/> Main or Reserve Stock	<input type="checkbox"/> Cash Retained/Reserve	<input type="checkbox"/> Other (Specify)	
		<input type="checkbox"/> Stamp Credit	<input type="checkbox"/> Unit		
Name of Employee	Clerk ID No.	Unit Name	Unit ID No.	Date of Examination	
Summary of Accountability (Attach a preliminary Form 1412 if applicable)			Cash and Cash Items on Hand (Cash Details Optional)		
1. Total Cash and Cash Items on Hand (Line 33)	Col. I	Col. II	Denomi- nation	Quality	amount
		\$0.00			
<b>Add Back Paid Out Items(Disbursements):</b>					
2. Refunds	\$0.00		\$100.00	0	\$0.00
3. Other	\$0.00		\$50.00	0	\$0.00
4. Other	\$0.00		\$20.00	0	\$0.00
5. Other	\$0.00	Tot. 2 thru 5, Col. I	\$10.00	0	\$0.00
		\$0.00			
6. Other		1 + 5, Col. II	\$5.00	0	\$0.00
		\$0.00			
<b>Less Cash Represented by accountability Items Other Than Stamp Stock (Receipts):</b>					
7. Money Order Vouchers	\$0.00		\$1.00	0	\$0.00
8. Forms 3544	\$0.00		0.50	0	\$0.00
9. COD Tags	\$0.00		0.25	0	\$0.00
10. Customer Meters, Form 3603	\$0.00		0.10	0	\$0.00
11. Post Office Meters/PV1 (Forms 3602-PO & current readings)	\$0.00		0.05	0	\$0.00
12. Box Rents Forms 1538	\$0.00		0.01	0	\$0.00
13. Retail Packaging Products	\$0.00		<b>26. Total Cash</b>		\$0.00
14. Other	\$0.00		27. Personal and Business Checks, Total		0
15. Other	\$0.00		28. Government Checks, Total		0
16. Other	\$0.00	Tot. 7 thru 16, Col. I	29. Paid Money Orders, Total		0
		\$0.00	30. Traveler's Checks, Total		0
17. Cash Portion of Stamp Credit		6 - 16 Col. II	31. Credit/Debit/PPC Card Receipts, Total		0
		\$0.00	32. Other (Describe)		0
<b>ADD:</b>			<b>33. Total Cash and Cash Items on Hand</b>		
18. Stamp Stock as Counted	\$0.00		(Total items 26 thru 32)		\$0.00
19. Envelope Discount, Forms 3220	\$0.00				
20. Stock in Transit (Returned but still in accountability)	\$0.00	Tot. 16 thru 20, Col. I			
		\$0.00			
<b>21. Total Cash and Stamp Stock</b>		Total 17 + 20 Col. II			
		\$0.00			
22. Opening Balance Stamps, AIC 840 or Cash Retained, AIC 353		\$0.00			
23. Difference		21 - 22 Col. II	Date	Amount	
		\$0.00			
24. Amount of Tolerance for this Credit	\$0.00				
25. Action Taken when Out of Tolerance					
<input type="checkbox"/> Trust <input type="checkbox"/> Suspense <input type="checkbox"/> Form 571					

PS Form 3294, January 1999 (page 1 of 4)

PCF1406

Figure 14-6.—An example of a PS Form 3294, Cash and Stamp Stock Count and Summary (page 1).

¢1	¢2	¢3	¢4	¢5	¢10
0	0	0	0	0	0
\$0.00	\$0.00	\$0.00	\$0.00	\$0.00	\$0.00
¢20	¢22	¢23	¢30	¢32	¢33
0	0	0	0	0	0
\$0.00	\$0.00	\$0.00	\$0.00	\$0.00	\$0.00
¢40	¢46	¢50	¢55	¢60	¢75
0	0	0	0	0	0
\$0.00	\$0.00	\$0.00	\$0.00	\$0.00	\$0.00
¢77	¢78	\$1.00	\$2.00	\$3.20	\$5.00
0	0	0	0	0	0
\$0.00	\$0.00	\$0.00	\$0.00	\$0.00	\$0.00
\$77.00	\$78.00	\$1.00	\$2.00	\$3.20	\$5.00
0	0	0	0	0	0
\$0.00	\$0.00	\$0.00	\$0.00	\$0.00	\$0.00
0	0	0	0	0	0
\$0.00	\$0.00	\$0.00	\$0.00	\$0.00	\$0.00
First Class Rate ¢0	FC Rate 2nd oz. ¢0	FC Rate 2nd oz. ¢0	P.S.A. \$0.00	P.S.A. \$0.00	P.S.A. \$0.00
0	0	0	0	0	0
	\$0.00	\$0.00	\$0.00	\$0.00	\$0.00
	Express Mail Rate \$0.00	Priority Rate \$0.00	Books \$0.00	Books \$0.00	Books \$0.00
	0	0	0	0	0
	\$0.00	\$0.00	\$0.00	\$0.00	\$0.00
	FC Rate Coils \$0.00	FC Rate Coils \$0.00	Coils \$0.00	Coils \$0.00	Coils \$0.00
	0	0	0	0	0
\$0.00	\$0.00	\$0.00	\$0.00	\$0.00	\$0.00

PS Form 3294, January 1999 (Page 2 of 4)

Total of page2

\$0.00

PCF1407

Figure 14-7.—An example of a PS Form 3294, Cash and Stamp Stock Count and Summary (page 2).



Stamped Envelopes, Cards, and Other Stamped Paper					
FC Envelopes ¢0	#6% Window ¢0	#10 Window ¢0	#6 3/4 Prec. Reg \$0.00	#10 Prec. Reg. \$0.00	#6 3/4 Prec. Window \$0.00
0	0	0	0	0	0
	\$0.00	\$0.00	\$0.00	\$0.00	\$0.00
	#10 Prec. Window \$0.00				
	0	0	0	0	0
\$0.00	\$0.00	\$0.00	\$0.00	\$0.00	\$0.00
FC rate Cards ¢0	Cards-Reply ¢0	Int'l Cards ¢0	Int'l Cards ¢0		
0	0	0	0	0	0
\$0.00	\$0.00	\$0.00	\$0.00	\$0.00	\$0.00
Aerogrammes ¢0	Reply Coupons ¢0	Bird ¢0			
0	0	0	0	0	0
\$0.00	\$0.00	\$0.00	\$0.00	\$0.00	\$0.00
			Use This Space for Computations		
\$0.00	\$0.00	\$0.00			
\$0.00	\$0.00	\$0.00			
Redeemed Stock					
\$0.00		\$0.00			

PS Form 3294, January 1999 (Page 3 of 4)

Total of Page 3

\$0.00

PCf1408

Figure 14-8.—An example of a PS Form 3294, Cash and Stamp Stock Count and Summary (page 3).

Inventory of Employees' Credit Containers (Annual)					
Equipment	Cash Drawer	Stamp Cabinet	Safe Compartment	Envelops Drawer	
Equipment Number					
Number of Keys					
Summary of Main/Reserve Stock Accountability					
Stamp Stock on Hand per count	\$		<input type="checkbox"/> Inventory Items Are Correct or Have Been Corrected		
Stamp Stock per Form 3958					
Difference	<input type="checkbox"/> Over	<input type="checkbox"/> Short			
Action Taken	<input type="checkbox"/> Trust	<input type="checkbox"/> Suspense	<input type="checkbox"/> Form 571		
Verification of Accountable Forms					
Form No.	Last Issued per Form 142		Next Form on Hand		
1538					
3210					
3544					
3582-C					
3602-PO					
3603					
Verification of Money Orders					
Domestic	Are they issued in sequence?		<input type="checkbox"/> Yes	<input type="checkbox"/> No	
Bait	Are they in good condition?		<input type="checkbox"/> Yes	<input type="checkbox"/> No	
International	Are they issued in sequence?		<input type="checkbox"/> Yes	<input type="checkbox"/> No	
Verification of Forms 3977 (Semi-Annual)					
Are signatures current?		<input type="checkbox"/> Yes		<input type="checkbox"/> No	
Are envelopes sealed and postmarked?		<input type="checkbox"/> Yes		<input type="checkbox"/> No	
Verification of Other Items (List)					
Notes, etc.:					
I have examined this stamp credit:			I agree to the count:		
(Signature of Supervisor)		(Date)	(Signature of Supervisor)		(Date)

PS Form 3294, January 1999 (Page 4 of 4)

PCf1409

Figure 14-9.—An example of a PS Form 3294, Cash and Stamp Stock Count and Summary (page 4).



Stamp Credit Examination Record

\*Use an asterisk to denote excessive cash. Line numbers are from Form 3294

Name of Employee				Location			
PCSN ABLE B. SEAMAN				SAFE # 2 USS UNDERWAY (CV-66) FPO AE 09561-0001			
Date of Count	Counted by (Name)	Stamp Credit Accountability COB Previous Duty Day Line 17 Col. 11	Stock Accounted for Line 15 Col. 11	Cash Portion * Line 12 Col. 11	Overage + Shortage - Line 18 Col. 11	Remarks	Next Count not Later than
10/10/01	BOATE SMITH	\$ 1,000 00	\$ 950 00	\$ 50 00			11/01
11/11/01	BOATE SMITH	\$ 1,000 00	\$ 953 94	\$ 43 11	\$ 2 95	WITHIN TOLLRANCE	12/01

PS Form 3368, September 1988 (Previous Editions Usable)

PCF1410

Figure 14-10.—An example of a completed PS Form 3368.

required to be submitted to authorities outside the command.

All assigned postal activities above mailroom level are required to have an inspection conducted by major commanders or their designated representatives. An audit of the COPE's accounts during this inspection will meet the annual inspection requirements as outlined in the DOD Postal Manual, Volume I.

Inspections of shipboard Navy post offices will be conducted under the guidance of the Navy Command Inspection Program. Postal Advisors may augment the immediate unit commander's command inspection team to conduct the shipboard postal functional part of the inspection. The audit conducted by this inspection will satisfy the monthly audit required for that time frame.

Commanding officers are encouraged to request postal assessment visits by Postal Advisors between formal command inspections. A formal inspection or postal assessment will be conducted on each shipboard military post office at no less than 18-month intervals, and annually for overseas shore-based post offices.

**VENDING EQUIPMENT SALES AND SERVICE (VESS) REPORTS**

Each COPE or MPC associated with self-service vending equipment must complete PS Form 8130, Vending Equipment Sales and Service Log, detailing the equipment serviced and maintained during each accounting period (see figure 14-11). All self-service vending-related time, out-of service codes, and costs must be reported. At the end of each accounting period, this report is submitted to NPFO San Diego.

Entering information on PS Form 8130 as follows:

**Reporting Period.**

Enter the accounting period and fiscal year for the corresponding information on the complete form.

**Location Information.**

ZIP + 4: Enter the ZIP + 4 for the geographical location of the equipment.

Location Name: Enter the name of the location.

Type Code: Enter the two-digit code (ML) from Table 14-2.

**Table 14-2.—Location Type Codes**

<b>Location Type</b>	<b>Code</b>
Postal Branch	BR
Postal Main Office	MO
Postal Station	ST
Postal Store	PS
Aviation/Airport	AV
Bank	BK
College/University	CL
Corporation	CO
Department Store	DS
Gift Shop	GS
Hospital	HP
Hotel	HT
Post Office Express	PE
Supermarket	SM
Mall	MA
Misc./Other	MI
Military Postal	ML

Street Address: Enter PSC and number followed by your box number. (Example: PSC 472 BOX 44; or for ships, USS \_\_\_\_\_.)

City and State: Enter FPO and appropriate AA, AE or AP.

Servicing Employee Name: Enter the Name of the MPC.

Work address: Enter PSC and number followed by your number; or for ships, USS\_\_\_\_\_.

ZIP + 4: Enter the ZIP + 4 Code.

Servicing Employee ID Number: N/A.

Commercial Number: Enter the telephone number of the serving post office.

Job Title: Check the appropriate box for the job title of the MPC.

**Machine Information.**

Machine Serial #: Enter the serial number located on the boiler plate affixed to the machine.

Model Code: Enter the model code from Table 14-3.

Model Name/Type: Enter the model name and type from the list in Table 14-3.

Add/Delete: Check the appropriate box to add or delete a machine.

Service Date: Enter the date service was performed.

Office Work Hours: Enter the number of hours and minutes spent counting currency, preparing deposits, requisitioning stock, completing accounting functions, auditing, ordering parts, and providing customer service including reimbursements.

Service Work Hours: Enter the number of hours and minutes spent servicing the equipment by loading stock, collecting cash, replacing modules, and performing general housekeeping.

Overtime: N/A.

Revenue: Enter the amount of money collected from the machine on each servicing day. At the end of the AP, total across all daily entries and place the sum in the last column at the right under AP Totals.

Transactions: Enter the number of transactions on each service day. At the end of the AP, total across all daily entries and place the sum in the last column at the right under AP Totals. Refer to Retail Vending Operational and Marketing Handbook, PO-102 for instructions on monitoring transactions for a particular machine type.

Out of Service: Enter a four-digit code based on the following; the first two digits represent the total number of days a machine is out of service; and the second two digits are based on the code numbers in Table 14-4.

**AP Total Information.**

Total Office Workhours/Minutes: Enter the sum total of all “b” entries.

Total Service Workhours/Minutes: Enter the sum total of all “c” entries. Enter the total time spent in transit for this location for the entire accounting period.

Miles Driven: N/A.

Miscellaneous Cost: N/A.

**POSTAL ACTIVITY REPORTING SYSTEM (PARS) INFORMATION REQUIREMENTS**

MPSA requires PARS quarterly financial reports from Navy post offices. These reports are designed to collect and report standard work data generated at Navy postal activities. The reports provide management with facts used to direct the day-to-day

**Table 14-3.—Current Equipment Codes**

Model Code	Item Number	Model	Machine Type
117	V-3504C	PS-53C	SVM
118	V-3504D	PS-53D	SVM
119	V-3504C	PS-53C MOD	SVM
120	V-3510	PS-22	SVM
205	V-1065D	PBM-2	BVM
206	V-1065E	PBM-6	BVM
207	V-1065D	PBM-2A	BVM
208	V-1065F	PBM-7	BVM
307	V-3508B	PCM-1625A	MCM
308	V-3508C	PCM-1625B	MCM
420	V-7407C	SCC-3	SCC
500		WRU	WRU
601	V-3508D	PBSM-624	BSM

**Table 14-4.—Out-of-Service Codes**

Code Number	Descriptor
01	Validator
02	Coin Mechanism
03	Controller
04	Dispenser
05	Electrical
06	Other
07	Jam
08	Jackpot
09	Switch
10	Physical Damage

operation of the MPS and to answer congressional or other official inquiries.

**REPORTING PROCEDURES**

PARS reports will be submitted quarterly to the appropriate FLTCINC postal officer. Reports must

reach the FLTCINC by the 10th of the month following the end of each quarter. The reporting quarters are as follows:

- 1st Quarter—OCT - DEC
- 2nd Quarter—JAN - MAR
- 3rd Quarter—APR - JUN
- 4th Quarter—JUL - SEP

For definitions of PARS data elements and an example of the message report format, refer to Appendix 4 of this TRAMAN or to the NPFO Handbook.

**POSTAL ASSISTANCE ADVISOR**

The Postal Advisor Program operates in conjunction with the *Navy Command Inspection Program*, SECNAVINST 5040.3A, and the *DOD Postal Manual*, Volume I. The Postal Advisor Program supports the Postal Agreement between USPS and DOD. Postal advisor billets are under operational control of CINCLANTFLT, CINCPACFLT, and CINCUSNAVEUR.

The purpose of the Postal Advisor Program is to assist commanding officers in the evaluation of daily postal operations and to provide technical training to



# Vending Equipment Sales and Service Daily Activity Log

(See Instructions on Reverse)

AP	FY
----	----

Location Information		Servicing Employee Information				AP Totals		Miles Driven
ZIP + 4		Servicing Employee Name		Servicing Employee ID Number		AP Total Office Workhours/Mins		
Location Name		Work Address		Commercial Number ( )		AP Total Service Workhours/Mins		
Street Address		City and State		Check One <input type="checkbox"/> SSSPC Tech <input type="checkbox"/> Clerk <input type="checkbox"/> Postmaster <input type="checkbox"/> Supervisor <input type="checkbox"/> Other:		AP Travel Time (Hours/Mins)		Misc. Cost
City and State		ZIP + 4				AP Total OT Workhours/Mins		
Machine Serial #: _____ Model Code: _____								
a. Service Date	:	:	:	:	:	:	:	<input type="checkbox"/> Add
b. Office	:	:	:	:	:	:	:	<input type="checkbox"/> Delete
c. Service	:	:	:	:	:	:	:	
d. Overtime	:	:	:	:	:	:	:	AP Totals
e. Revenue	:	:	:	:	:	:	:	\$
f. Transactions <small>(See Reverse)</small>	:	:	:	:	:	:	:	
g. Out-of-Service	:	:	:	:	:	:	:	
Machine Serial #: _____ Model Code: _____								
a. Service Date	:	:	:	:	:	:	:	<input type="checkbox"/> Add
b. Office	:	:	:	:	:	:	:	<input type="checkbox"/> Delete
c. Service	:	:	:	:	:	:	:	
d. Overtime	:	:	:	:	:	:	:	AP Totals
e. Revenue	:	:	:	:	:	:	:	\$
f. Transactions <small>(See Reverse)</small>	:	:	:	:	:	:	:	
g. Out-of-Service	:	:	:	:	:	:	:	
Machine Serial #: _____ Model Code: _____								
a. Service Date	:	:	:	:	:	:	:	<input type="checkbox"/> Add
b. Office	:	:	:	:	:	:	:	<input type="checkbox"/> Delete
c. Service	:	:	:	:	:	:	:	
d. Overtime	:	:	:	:	:	:	:	AP Totals
e. Revenue	:	:	:	:	:	:	:	\$
f. Transactions <small>(See Reverse)</small>	:	:	:	:	:	:	:	
g. Out-of-Service	:	:	:	:	:	:	:	

Figure 14-11.—An example of a PS Form 8130.

## INSTRUCTIONS

Record accounting period (AP) activity for vending equipment on this form. Each employee associated with the vending equipment operation must complete a form detailing the equipment serviced and maintained during the accounting period. All vending equipment related time and costs must be reported.

### REPORTING PERIOD

Enter the accounting period and fiscal year for which the information on this completed form represents.

### LOCATION INFORMATION

**ZIP + 4** Enter the ZIP + 4 for the geographical location where the equipment is located (i.e., if the equipment is installed in a free standing unit in a shopping mall parking lot use the ZIP + 4 assignment for the mall).

**NAME** Enter a location name that local personnel will recognize when referencing the location.

**ADDRESS** Enter the street address of the location.

**CITY / STATE** Enter the city and state of the location.

**TYPE CODE** Enter the two-digit type code from the list below.

**TOTAL OFFICE HOURS** Enter the sum total of "b" entries here.

**TOTAL SERVICE HOURS** Enter the sum total of "c" entries here.

**TRAVEL TIME** Enter the total time spent in transit for this location for the accounting period.

**TOTAL O.T.** Enter the sum total of OT entries here.

**MILES DRIVEN** Enter the total mileage charged to this location for the accounting period.

**MISC. COST** Enter the dollar and cent amount for any rent, utilities, or cleaning supplies used during the accounting period. (i.e., Enter one hundred and twenty-five dollars and thirty-five cents as \$125.35. Enter one hundred and twenty five dollars as \$125.00).

### SERVICING EMPLOYEE INFORMATION

**I.D. #** This number is assigned by the database when the location is established. A new employee will be given the next sequential number by the VESS system database. This number may be determined by contacting the Division VESS program administrator.

**NAME** Enter the name of servicing employee whose activities are reported on this form.

**ADDRESS** Enter the street address where servicing employee is domiciled.

**CITY / STATE** Enter the city and state where the servicing employee is domiciled.

**ZIP + 4** Enter the ZIP + 4 where the servicing employee is domiciled.

**TEL. #** List the COMMERCIAL telephone numbers if known.

**JOB TITLE** Check the appropriate box. If "OTHER" include title and pay level.

### MACHINE INFORMATION

**MACH. SERIAL #** Enter the serial number located on the boiler plate identification tag affixed to the machine.

**MODEL CODE** Enter the appropriate model code from the list below.

**MODEL NAME/TYPE** Enter the appropriate model name / type from the list below.

**ADD / DELETE** Check the appropriate box to add or delete a machine.

a. Enter the **service date** of service activities.

Enter the number of **office workhours**. Office workhours are workhours are the number of hours and minutes spent counting currency, preparing deposits and stock requisitions, performing accounting functions, auditing, depositing currency, arranging for repair and replacement of failed subassemblies, and providing customer service including reimbursements.

c. Enter the number of **service workhours**. Service workhours are workhours are the number of hours and minutes spent servicing the equipment by loading stock, collecting cash, replacing modules (troubleshooting), and general housekeeping.

d. Enter the number of **overtime** hours. Postal overtime pay is a premium pay to eligible employees for work performed after eight paid hours in any one service day or forty paid hours in any one service week.

e. Enter revenue. **Revenue** is the money collected from the machine on each servicing day. Add all daily entries and place the sum total in the column to the right. (i.e. One hundred twenty-five dollars thirty-five cents should be entered as \$125.35. One hundred twenty-five dollars should be entered as \$125.00).

f. **When requested** to monitor transactions, enter the total number of transactions generated by the corresponding machine during the accounting period. (Refer to Retail Vending Operational and Marketing Handbook, PO-102 for instructions on monitoring transactions for a particular machine type.)

g. Enter the **out-of-service** code. The out-of-service code is the four digit code based on the following: the first two digits represent the total number of days a machine is out-of-service. The second two digits are based on the following code table:

- 01 - VALIDATOR
- 02 - COIN MECHANISM
- 03 - CONTROLLER
- 04 - DISPENSER
- 05 - ELECTRICAL
- 06 - OTHER
- 07 - JAM
- 08 - JACKPOT
- 09 - SWITCH
- 10 - PHYSICAL DAMAGE
- 11 - RELOCATION

**EXAMPLE:** 04 03

The first two digits indicate the machine was OUT-OF SERVICE for four days. The second two digits indicate the primary reason was a defective controller.

**NOTE:** In the event a machine is inoperative for various reasons on different dates during the accounting period, indicate the OUT-OF-SERVICE code you feel was most predominant in the AP TOTALS column.

### AP TOTALS

Total rows b thru g, left to right, for each machine listed. Enter the sum in the appropriate AP TOTALS block. (Make entries for items "f" and "g" only when applicable.)

### CURRENT EQUIPMENT CODES

MODEL CODE	ITEM NUMBER	MODEL NAME	TYPE
117	V-3504C	PS-53C	SVM
118	V-3504D	PS-53D	SVM
119	V-3504C	PS-53C MOD	SVM
120	V-3510	PS-22	SVM
205	V-1065D	PBM-2	BVM
206	V-1065E	PBM-6	BVM
207	V-1065D	PBM2A	BVM
208	V-1065F	PBM-7	BVM
307	V-3508B	PCM-1625	PCM
308	V-3508C	PCM-1625B	PCM
420	V-7407C	SCC-3	SCC
500	V-	WRU	WRU
601	V-3508D	PBSM-624	BSM

### LOCATION TYPE CODES

LOCATION TYPE	CODE
Postal Branch	BR
Postal Main Office	MO
Postal Station	ST
Postal Store	PS
Aviation / Airport	AV
Bank	BK
College	CL
Corporation	CO
Department Store	DS
Gift Shop	GS
Government Location	GL
Hospital	HP
Hotel	HT
Post Office Express	PE
Supermarket	SM
Mall	MA
Misc. / Other	MI
Military Postal	ML

Figure 14-11b.—An example of a PS Form 8130.

personnel assigned to postal duties. Postal advisors provide postal orientation to newly designated personnel, and assist, advise, and train personnel at Navy post offices around the world. Some of these personnel include postal officers, postal clerks, reserve custodians, other military and civilian personnel assigned to postal duties, and auditors.

The easiest and most useful way to make sure postal operations are current and conducted properly is to make maximum use of the postal advisors. Postal advisors are usually senior postal clerks (E-7s to E-9s) and civilians with an extensive postal background who are assigned to selected fleet concentration centers, both in the United States and overseas.

The knowledge and experience of postal advisors can be used to support required training. The advisors can detect unidentified discrepancies (those not yet found), and give recommendations needed to correct identified postal discrepancies. The advisors are able to make recommendations for physical improvements of postal spaces and equipment to improve the flow of mail. Keep in frequent contact with your homeport postal advisor. You should take advantage of any training offered by the advisor(s). Postal advisors are located at FMC Yokohama, Japan; NRCC Manila, RP; San Diego, Ca; Pearl Harbor, HI; Norfolk, VA; Mayport, FL; and Naples, Italy.

Other areas of importance to a postal operation that require the services of a postal advisor are inspections, investigative assistance, audits, predeployment briefings, and general help and advice on all postal matters.

Regardless of the effectiveness of local training programs, using your postal advisor cannot be overemphasized. Postal policies and practices are continuously changing. This normally affects the operation of the MPS. The postal advisors are knowledgeable and experienced in the full scope of postal responsibilities. They are readily available to give necessary guidance.

*Q14-9. What personnel are responsible for completing PS Form 8130, Vending Equipment Sales and Service Log?*

*Q14-10. What information does the PARS report provide?*

*Q14-11. How often are PARS reports required to be submitted?*

*Q14-12. On what date must the PARS report reach the FLTCINC?*

*Q14-13. Postal Advisor billets are under operational control of what major command(s)?*

Now turn to appendix 1 to check your answers.

## POSTAL MESSAGES

---

**Learning Objective:** *Recall the different types of messages generated at an MPO.*

---

Messages are the form of written communication used in the Navy when speed of transmission is important. The message system is designed to get time-sensitive or even critical information to addressees rapidly for effective use of information. The preparation of naval messages is a routine task of postal clerks in the Navy. Daily mail on-hand reports, postal net alerts (PNAs), mail routing instructions (MRIs), and postal offense reports are prepared by postal personnel and sent through the Navy's telecommunication system.

Like correspondence preparation, message writing will become easier with practice.

### POSTAL NET ALERT

The Postal Net Alert (PNA) is a system of communicating between postal activities by supplying information about the status of mail movement. PNAs can be used to report air and surface irregularities, which include incidents such as facility problems and mechanical breakdowns affecting the transportation or processing of mail.

The PNA message can be a good information tool. PNAs report information on matters directly affecting mail movement such as the following:

- Improper labeling or tagging of mail
- Airport closures
- Mail loaded or off-loaded in error
- Change in airline ability to make transfers
- Last-minute flight schedule changes
- Unsuccessful airline transfers
- Airline carrier backlogs

Postal officers can use PNA messages to create an information link between dispatching, transiting, and receiving activities. PNA messages are one of the more important building blocks of an integrated mail transportation network. PNAs sent between local post



offices do not need to follow a specific format. They should just say what has to be said, giving the facts of the incident and the action taken or recommended (see figure 14-12). Distribution of PNAs should be on a need-to-know basis only. If a command is not affected by the incident, or has no need to know, do not list it on the info line of the message.

The PNA is a tool that is encouraged to be used by all postal managers when needed. It should be used to report intra-theater mail problems in addition to concerns on mail moving to and from CONUS. Do not include the JMPAs or MPSA as addressees when the information is of distinct local interest only. Your PNA distribution should only include the serving JMPA or MPSA if it concerns mail moving to or from CONUS.

### MAIL ON HAND/DISPATCH REPORT

Daily mail on hand/dispatch reports are required from all ships and shore activities holding mail for other units. The first section of the report shows the amount of mail on hand and for which unit, while the final section shows mail that was delivered or dispatched since the last report. Ships functioning as

Passenger Mail Cargo Coordinator (PMCC) should show any mail received for ships not present with the battle group.

Mail on hand/dispatch reports permit commands to monitor mail flow and to provide special routing instructions when necessary. Mail on hand/dispatch reports are sent in message format with PRIORITY precedence (see figure 14-13).

### MAIL ROUTING INSTRUCTION (MRI)

The routing and dispatching of Navy mail for units operating out of their home ports or when they are deployed overseas is carried out by responsible mail routing activities using information provided to them by each unit in the form of MRIs.

The responsibility for submitting MRIs lies with the ship or other mobile unit's commanding officer; however, generally the command postal clerk will provide a draft of the message for approval by the postal officer. MRIs are submitted to the appropriate JMPA and area mail coordinators as designated by the appropriate FLTCINC.

UNCLASSIFIED

FM: FMC DET ROME IT

TO: USS UNDERWAY

INFO: CDR JT MIL POSTAL ACTY ATL NEW YORK NY//MPSA-NY-MR//  
MEDMAIL COORD NAPLES IT//N401B//  
COMNAVSUPSYSCOM MECHANICSBURG PA//SUP54//

UNCLAS//N05110//

MSGID/GENADMIN/FMC DET ROME IT//

SUBJ/POSTAL NET ALERT//

RMKS/

1. ORIG HAS RECEIVED WORD OF POSSIBLE CRASH CREW STRIKE AT ROME'S INTL AIRPORT ON 10 MAR 01. IF STRIKE GOES INTO EFFECT IT WILL CAUSE AN APPROX 12-HOUR DELAY OF RETROGRADE MAIL.
2. WILL ADVISE BY SEPARATE MSG IF STRIKE CONTINUES PAST 12 HOURS.//

UNCLASSIFIED

Figure 14-12.—An example of a postal net alert (PNA) message.

UNCLASSIFIED

FM: COMNAVACT LONDON UK

TO: USS UNDERWAY  
USS DESTROYER  
USS CRUISER  
USNS OILER

INFO: CDR JT MIL POSTAL ACTY ATL NEW YORK NY//MPSA-NY-MR//  
CINCLANTFLT NORFOLK VA//N412P/N412P1//  
COMNAVSUPSYSCOM MECHANICSBURG PA//SUP54//

UNCLAS//N05110//

MSGID/GENADMIN/FMC DET ROME IT//

SUBJ/MAIL ON HAND/DISPATCH REPORT

RMKS/1. THE FOLLOWING MAIL ON HAND AT NPO LONDON AS OF 1601Z 30 JUN 01. ALL WEIGHTS ARE LISTED IN KILOS.

UNIT	LCM/PRI/MOM/SAM	REGS	ANTICIPATED DISP DATE
USS UNDERWAY	325/000/000/000	020	FAM
USS DESTROYER	020/000/000/000	000	OSL 07/01
USS CRUISER	083/000/000/000	005	PORTMOUTH 07/01
USNS OILER	010/000/000/000	001	FAM

2. THE FOLLOWING MAIL DISP BY ORIG ON 30JUN01.

USS UNDERWAY	450/000/000/000	045	VIA HELO
USS DESTROYER	100/000/000/000	005	VIA HELO CV-66 FFT
USS CRUISER	076/000/000/000	001	VIA HELO CV-66 FFT
USNS OILER	000/000/000/000	010	VIA HELO CV-66 FFT

3. RETOGRADE MAIL ON HAND OVER 24 HOURS: NONE

UNCLASSIFIED

Figure 14-13.—An example of a Mail on Hand/Dispatch Report.

As you have learned, MPSA has established offices at the gateways to provide mail routing instructions to USPS. JMPA-ATL or JMPA-PAC, located at New York and San Francisco respectively, have been assigned overall mail routing and monitoring responsibility for all mobile units.

The action addressee on all MRIs will be the responsible JMPA and/or area mail coordinator, if applicable. The information addressees should be all other activities with a need to know (any activity involved in the delivery or receipt of your ship or unit's mail), such as FLTCINCs, FMCs, aircraft carriers or

auxiliary ships, naval stations, and so forth. Embarked units should always be indicated as embarked on a ship's MRI; however, this does not relieve the embarking/debarking unit of the responsibility of submitting its own MRI. MRIs should be sent using PRIORITY precedence, (info addresses should be sent ROUTINE), and as far in advance as possible to ensure the successful receipt of mail (see figure 14-14). The MRI should remain current and should project mail routing information for a reasonable length of time to provide positioning of all classes of mail.

Major commanders may designate area mail coordinators responsibility for issuing and coordinating intra-theater routing for mobile units in their respective area. Many of the area mail coordinators issue instructions that are unique to their particular area of responsibility. These instructions are helpful to mobile commands in the preparation of MRIs and also in dispatching and receiving mail.

### **SPECIAL REPORTS OF POSTAL VIOLATIONS, LOSSES, AND OFFENSES**

Postal offenses are occurrences of violating laws, agreements, or USPS and DOD regulations, which jeopardize the security of mail, postal effects, and other USPS or DOD property. The *DON Postal Instruction* and the *DOD Postal Manual*, Volume 1, provides detailed information about reporting postal losses and offenses.

DOD is responsible for making sure USPS is reimbursed for the loss of funds, postage stock, and accountable mail because of embezzlement, negligence, or theft while in the custody of the MPS. Investigation by the military services may be required to determine individual liability. An investigating officer may be a commissioned officer, warrant officer, or senior enlisted person (E-7 through E-9) appointed to investigate postal offenses or losses.

Examples of postal offenses that must be investigated are as follows:

- Theft, destruction, manipulation, misappropriation or embezzlement of postal funds, blank money order forms, money order imprinters, mail keys, stamps, stamped paper, or meter postage or postmarking devices
- Altering, counterfeiting, forging, or fraudulently passing money orders and other postal paper

The *DOD Postal Manual*, Volume 1, chapter 14, lists various other postal offenses that must be reported.

Reports are made in message format (see figure 14-15) within 72 hours of discovery with follow up reports made every 30 days thereafter or until MPSA closes the case. Postal losses such as stamp stock account shortages or missing money order vouchers discovered during routine audits are not required to be reported as postal offenses unless criminal intent is suspected.

*Q14-14. What type of correspondence is the Navy's quickest form of written communication?*

*Q14-15. Explain the purpose of a postal net alert (PNA).*

*Q14-16. What specific format is used when submitting a PNA message?*

*Q14-17. What units are required to submit mail on hand/dispatch reports?*

*Q14-18. What individual is responsible for submitting a mail routing instruction?*

*Q14-19. Postal offenses that occur in a Navy postal facility should be reported within what total number of hours after discovery?*

Now turn to appendix 1 to check your answers.

### **POST OFFICE FILES AND RECORDS**

---

**Learning Objective:** *Recall the procedures for setting up and maintaining postal files and records.*

---

The size and type of an MPO will generally dictate the type of container or space needed for maintaining files and records. Large shorebased MPOs will in some cases need a separate space for administrative files where as a small shipboard MPO will only use a filing cabinet. The following information will aid in setting up a postal filing system, and ensuring your system provides adequate security.

### **SETTING UP POSTAL FILES**

As a minimum, your filing system should be organized into five main sections: (1) Administration, (2) Financial, (3) Supply, (4) Operations, and (5) Records. Additional file sections may be added as needed. Correspondence on each individual section should be filed as shown below.

#### **1. ADMINISTRATION**

CONFIDENTIAL

FM: USS UNDERWAY

TO: CDR JT MIL POSTAL ACTY ATL NEW YORK NY//MPSA-NY-MR//

INFO: CINCLANTFLT NORFOLK VA//N412P/N412P1//

COMNAVACT LONDON UK//A111//

USS DESTROYER

USS CRUISER

USNS OILER

FIGHTER SQUADRON ONE ZERO FOUR

SEA CONTROL SQUADRON THIRTY EIGHT

HELICOPTER ANTISUBMARINE SQUADRON ELEVEN

CARRIER AIRBORNE EARLY WARNING SQUADRON ONE TWO TWO

CONFIDENTIAL//N05110//

MSGID/GENADMIN/USS UNDERWAY//

SUBJ/MAIL ROUTING INSTRUCTION 6-01

REF/A/RMG/USS UNDERWAY/151600ZMAY01//

AMPN/REF A IS MAIL ROUTING INSTRUCTION 5-01//

RMKS/1. (U) CANCEL REF A.

2. (C) THE FOLLOWING INFO IS PROVIDED FOR MAIL ROUTING PURPOSES ONLY:

PORT/LOCATION	ETA	ETD
NORFOLKVA	PRES	0800 15JUN01
UNDERWAY WEST ATLANTIC	15JUN01	17JUN01
UNDERWAY NORTH ATLANTIC	17JUN01	01JUL01
INPORT PORTSMOUTH	UK	01JUL01UFN

3. (C) SHIPS IN COMPANY: USS DESTROYER, USS CRUISER, USNS OILER.

4. (C) EMBARKED UNITS: VF-104, VS-38, HS-11, VAW-122.

CONFIDENTIAL

Figure 14-14.—An example of a Mail Routing Instruction (MRI).

Letters of Appointment	Postal Assessment Visit Records
Designation/termination, DD Form 2257	Postal Activity Reporting System (PARS) reports
General Correspondence	Supplies and Equipment Receipt, PS Form 1590
Command Postal Standard Operating Procedures/ Postal Operating Plan (SOP/POP)	Instructions and Notices 5110 through 5119
UNCLAS Messages (Incoming)	Unit Mail Clerk/Orderly Designation Log, DD Form 2260
UNCLAS Messages (Outgoing)	2. FINANCIAL

UNCLASSIFIED

FM: USS UNDERWAY

TO: EXEC DIR MIL POSTAL SVC AGCY ALEXANDRIA VA//MPSA-OP//

INFO: CINCLANTFLT NORFOLK VA//N412P/N412P1//  
COMNAVSUPSYSCOM MECHANICSBURG PA//SUP54//

UNCLAS//N05115//

MSGID/GENADMIN/USS UNDERWAY//

SUBJ/TYPE OF POSTAL OFFENSE, INCIDENT, CATASTROPHE, OR TYPE OF FUNDS INVOLVED  
AND AMOUNT//

RMKS/1. IN COMPLIANCE WITH DOD 4525.6-M, VOL I, CHAP 14, PARA 1402, THE FOLLOWING  
INFO IS FURNISHED:

A. DATE INCIDENT OCCURRED, KNOWN FACTS AND CIRCUMSTANCES AND ORGANIZATION  
INVOLVED (INCLUDE OFFICE ID NUMBER AND ZIP CODE).

B. PERSONNEL INVOLVED: INDICATE WHETHER A POSTAL CLERK OR A MAIL ORDERLY IS  
RESPONSIBLE FOR THE LOSS.

C. INDICATE WHETHER RESTITUTION HAS BEEN MADE, OR WILL BE MADE AND WHEN.

D. REFLECT INFORMATION RELATING TO RECOVERY AND DISPOSITION OF MAIL AND  
INCLUSIVE DATES OF SUCH MAIL. IF ACCOUNTABLE MAIL IS INVOLVED, INDICATE  
AMOUNT, TYPE, ACCOUNTABLE NUMBERS, CONTENTS AND VALUE, IF KNOWN. IF BEING  
HELD AS EVIDENCE, SO STATE, AND GIVE AMOUNT AND ESTIMATED DATE OF RELEASE. IF  
MAIL SERVICE IS INVOLVED, REPORT WHETHER PREVIOUS INCIDENTS HAVE OCCURRED  
AND, IF SO, GIVE DATE(S).

E. INDICATE DATE REFERRED TO INVESTIGATIVE AGENCY, INCLUDING AGENT'S NAME,  
DESIGNATION, LOCATION, AND CASE NUMBER ASSIGNED, AS APPROPRIATE. IF OFFENSE  
OCCURRED IN CONUS, INCLUDE DATE; AND LOCATION OF USPS POSTAL INSPECTOR WHO  
WAS NOTIFIED.

F. STATE CORRECTIVE ACTION TAKEN TO PREVENT RECURRENCE, AS APPROPRIATE.

2. INDICATE THE DATE AND THE NAME OF THE COMMAND, WHICH DESIGNATED THE  
INDIVIDUAL AS MPC, FPC, COPE, OR FPO. (IF PARAGRAPH DOES NOT APPLY, OMIT FROM  
MESSAGE.)

UNCLASSIFIED

Figure 14-15.—An example of a postal offense message.

Stamp Requisition, PS Form 17

Money Order Requisition, PS Form 17

Report of Audit of Postal Accounts, DD Form 2259/PS  
Form 3294

Retail Vending Credit Examination, PS Form 3293

Military Post Office Report of Money Order Business, PS Form 6019

Vending Equipment Sales and Service Report, PS Form 8130

### 3. SUPPLY

Requisition for Rubber and Steel Stamps Only, PS Form 1567

Requisition for Facing Slips or Labels, PS Form 1578B

MDC Supply Requisition, PS Form 7380

Requisition for Supplies, Services, or Equipment, PS Form 7381

### 4. OPERATIONS

Military Mail AV-7 Delivery List, PS Form 2942-A (Incoming)

Military Mail AV-7 Delivery List, PS Form 2942-A (Outgoing)

Mail Manifest, OPNAV Form 5110/9 (Incoming)

Mail Manifest, OPNAV Form 5110/9 (Outgoing)

Transportation Control and Movement Document (TCMD), DD Form 1384

Mail Manifest, DD Form 1372

Mail Routing Instructions

Mail On Hand Reports

Mail Dispatch Reports

Postal Net Alerts

### 5. RECORDS

Mail Call Sheets

Registered Bills (Incoming)

Registered Bills (Outgoing)

Domestic Claim or Registered Mail Inquiry, PS Form 1000

Mail Loss/Rifling Report, PS Form 1510

The *Department of the Navy Information Security Program Regulation*, SECNAVINST 5510.36, defines the security requirements for file cabinets that contain classified material.

## SAFEGUARDING POSTAL RECORDS

Protection given to the mails is always of utmost concern. The same applies for postal records. This section briefly discusses the safeguarding of postal

records and how to deal with individuals when examination of postal records may become necessary.

Information regarding postal matters may not be released except as provided below:

- Agencies or individuals (such as the Naval Criminal Investigative Service (NCIS) or NCIS agents) desiring to examine USPS records must have written approval from the commanding officer.
- Photostats or true copies of records must be released only with prior approval of the commanding officer concerned.
  - When a commanding officer deems necessary, original records may be released. Notification of release must be reported to MPSA through the chain of command.
- Records pertaining to individual transactions of customers as distinguished from official investigations must be released only with prior approval of USPS Headquarters, Washington, DC. Normally, before any individual agent or agency representative requests to examine USPS records, he or she will already have a very good reason and also permission. However, you must inform your postal officer whenever you receive a request to examine USPS records. After authorization is received, you should help the individuals in a professional and courteous manner.
- Mailing addresses for transferred personnel may be given to authorized individuals for official business purposes only.

## RETENTION PERIOD FOR RECORDS AND FORMS

Retention periods for postal records and forms are located in the ASM. Below is a list of the more commonly used records and forms and their retention periods.

PS Form 1000—3 years

PS Form 3849—2 years

PS Form 6019—2 years

Registered mail records—2 years

PS Form 17 (stamp requisition/return)—2 years

PS Form 17 (money order requisition)—Retain until series has been used

Records and forms pertaining to military forms and records are not included in the ASM. Below is a list of those forms and records.

All DOD Forms—2 years

OPNAV 5110/5 (directory card)—12 months after transfer

OPNAV 5110/9 (ordinary mail manifest)—6 months

OPNAV 5110/9 (registered mail manifest)—2 years

Mail call log sheet—6 months

PS Form 2976—30 days

All records used with the Unisys III will be retained for 4 years.

### STANDARD OPERATING PROCEDURES AND POSTAL OPERATING PLAN

---

**Learning Objective:** *Recall procedures for the development of a command Standard Operating Procedure (SOP) and Postal Operating Plan (POP).*

---

The following information provides instruction for the development of command standard operating procedures (SOP) and postal operating plans (POP).

#### STANDARD OPERATING PROCEDURES

Commanding Officers must make sure a local postal service directive or instruction is produced. This directive or instruction should be called the standard operating procedures (SOP). It should cite information relative to mail services and facilities of the command. A sample SOP is shown in appendix 3 of this NRTC. The SOP should contain, at a minimum, the following:

- Correct and complete mailing address including division, department, detachment, code, squadron, and unit number to be used by personnel attached to the command.
- Location and hours of operation of the post office serving the command.
- Location and hours of operation of the mail room, if applicable.
- Location and hours of collection from receptacles supplied for posting outgoing mail.

- Time and method of distributing incoming mail.
- Instructions relative to customs requirements and customs regulations in locations where they are needed.
- Instructions for completing Notice of Change of Address, OPNAV Form 5110/5, cards.
- List of non-mailable articles.
- Security measures to be followed for the protection of the postal facility, mail, and postal effects.
- Emergency destruction procedures for USPS postal effects, funds, and mail, listing the items in priority order of destruction.
- Information on Mail Bombs.
- Duties of the postal officer, COPE, etc.
- Transportation schedule for outgoing and incoming mail.
- Guidelines to account for blank money order forms.

Where applicable, the SOP may be combined with the command POP. The SOP should be posted in an area accessible to all postal customers for their information.

All MPS operating activities must review and update their SOP at least annually.

#### POSTAL OPERATING PLAN

The role of the POP is to supply postal management with a method to document the processes to be done, target times to be met, and basic information needed to manage an MPO. It must be used at the managerial and planning level as well as at the operating level. The POP is a map of the postal operation and can be a valuable management tool to indoctrinate newly reporting postal officers and supervisors.

The POP enables postal officers or supervisors to plan mail processing operations and coordinate them with transportation schedules. Each section of the POP should be made with a view toward the following goals:

- Streamlining mail-processing operations.
- Integrating mail transportation systems.
- Making operations more efficient and economical.
- Determining facility layout.

- Determining equipment requirements.
- Determining work schedules.
- Determining manpower requirements.

All MPS operating activities must review and update their POP at least annually. Changes should also be made when information is no longer accurate or becomes obsolete. All MPOs have different written plans to meet their command's unique requirements. Prepare only those parts of the plan applying to your postal operation. Most shipboard post offices probably would not prepare a ground transportation schedule or include mail-processing targets in the POP but all land-based MPOs should.

When the mail is ready for pickup, the Navy PC receipts for it, brings it back to the post office, and then sorts it and holds mail call. Large shipboard post offices such as those on board aircraft carriers should include a transportation or logistics section to include flight deck and underway replenishment (UNREP) operations.

During these high-tempo operations, PCs must be flexible and follow a good solid plan. During any operation, communication is a major part of the overall plan. This plan should be well thought out and rehearsed if these fast paced evolutions are to run smoothly. The basic POP consists of the following seven sections:

- Table of contents. This section lists each section of the POP and the date prepared or updated. Some sections may not need updating while others may need to be reviewed and updated frequently.
- Basic information. This section provides daily, monthly, and yearly mail volume data. Fleet exercise mail volume data should also be listed in this section.
- Basic facility data. This section supplies basic information including facility layout, mail processing equipment, and case and rack design.

- Mail processing profile. This section shows the average daily volume of mail received and dispatched during a normal workday. The daily average is found by conducting counts over a specified period.
- Mail processing targets. This section contains specific mail processing target times to optimize mail processing. It documents the time mail must be available for processing at each sequential step.
- Transportation. This section has information about transportation networks used by the activity to fulfill its postal mission.
- Special instructions. This section contains special instructions highlighting unique roles or clarifies the operation of the postal activity. This could include a map of mail collection boxes on the facility and collection times or other information that might be helpful.

Remember, the information provided is only a guide and each postal activity should include only those sections pertaining to its operation.

*Q14-20. As a minimum, your MPO filing system should consist of what five main sections?*

*Q14-21. What official at your command has the authority to release original postal records?*

*Q14-22. When original records are released to NCIS, what agency outside of your command must be notified?*

*Q14-23. What publication lists the retention periods for USPS forms?*

*Q14-24. At least how often should your command SOP and POP be reviewed and updated?*

Now turn to appendix 1 to check your answers.



## APPENDIX I

# ANSWERS TO REVIEW QUESTIONS

The following answers are for review questions contained in this NRTC and are provided as a means to check your knowledge of the material you have studied.

### Answers to review questions for chapter 1.

- 1-1. The basic mission of the military postal service (MPS) is to provide service to Department of Defense (DOD) agencies in support of DOD missions.
- 1-2. The Secretary of the Army.
- 1-3. USPS Publication 38.
- 1-4. To provide, as a minimum, a level of service equal to that provided by the USPS to the civilian sector in the United States.
- 1-5. The National Five-Digit ZIP Code and Post Office Directory (Publication 65-A).
- 1-6. U.S. Postal Service (USPS).
- 1-7. True.
- 1-8. (1) Have no record of conviction by courts martial or punishment under Article 15 involving a postal-related incident; (2) Have no record of civilian conviction other than minor traffic violations; (3) have no record of derogatory information or unfavorable conduct that casts doubt on the military member's trustworthiness and honesty; (4) possess high moral standards and excellent military bearing; (5) have no record of psychiatric disorder, alcoholism, or drug abuse, unless a medical evaluation determines the condition no longer exists; (6) be financially responsible; (7) not have been relieved previously for cause or criminal convictions from military postal duties; (8) be a U.S. citizen and eligible for a Secret clearance; (9) not have physical restrictions prohibiting duty involving prolonged standing, walking, or lifting of weights up to 70 pounds; (10) have a physical profile serial code (PULHES) of 211221.
- 1-9. False.
- 1-10. To hold a portion of the assigned stamp stock (stamps and cash) and blank money order forms.
- 1-11. The disbursing officer.
- 1-12. Commanding officer.
- 1-13. The nearest postal assistance advisor.
- 1-14. United States Army.
- 1-15. DOD Postal Manual.
- 1-16. National Five-Digit ZIP Code and Post Office Directory, or Standard Navy Distribution List (SNDL).
- 1-17. The Postal Bulletin provides official information such as temporary instructions, special instructions, changes to USPS manuals, new USPS forms, stolen money order list, and information of general interest to postal personnel.
- 1-18. False.

- 1-19. DOD-operated dependent schools, DOD nonappropriated fund activities, American Red Cross, United Service Organizations, Inc. (USO), overseas military banking facilities and credit unions, masters and civilian crews of the Military Sealift Command (MSC) ships and merchant ships operating for the account of the MSC visiting your port.
- 1-20. 90 days advance notice of withdrawal of service will normally be given to any organization or individual.
- 1-21. Balloting material.

**Answers to review questions for chapter 2.**

- 2-1. DOD Postal Manual and the Department of the Navy Postal Instructions.
- 2-2. Page 13 entry must be made when you are initially designated as a military postal clerk and will last throughout your career.
- 2-3. DD Form 285.
- 2-4. Mail orderlies must be properly trained and have explained to them the importance of postal services, individual responsibilities, and the negative consequences if they do not perform assigned postal duties according to established procedures and instructions.
- 2-5. To provide a command or division with a record of names and DD Form 285 numbers in numerical sequence for assigned mail orderlies.
- 2-6. 2 years after the last entry on the log has been revoked.
- 2-7. A DD Form 2257 designation as command's COPE.
- 2-8. Not more than 5 consecutive working days.
- 2-9. Chief postal clerk (E-7).
- 2-10. Reserve custodian and/or assistant clerks.
- 2-11. The command's monies audit board.
- 2-12. 2 years from the termination date.
- 2-13. Commissioned or warrant officer (normally the reserve custodian).
- 2-14. DD Form 285.

Answers to review questions for chapter 3.

- 3-1. Easy, average, and difficult loads.
- 3-2. 125 pounds.
- 3-3. True.
- 3-4. When the box itself is an adequate shipping container.
- 3-5. 10 times the girth of the article.
- 3-6. It must have a positive closure such as a screw-on top or one that is secured by bolts or clamps.
- 3-7. Foamed plastics, rubberized hair, corrugated fiberboard, excelsior (wood shavings), shredded newspaper.
- 3-8. Cellophane and masking tape.
- 3-9. Paper tape.
- 3-10. The metal straps must have a smooth or have plastic-coated edges.
- 3-11. 5 inches apart.
- 3-12. 30 inches.
- 3-13. The first digit of the ZIP Code divides the country into 10 large groups of states numbered from 0 to 9.

- 3-14. True.
- 3-15. The ship's homeport.
- 3-16. The Standard Navy Distribution List (SNDL), parts 1 and 2, and annex A to part 1.
- 3-17. Whenever box numbers, barracks, or division numbers, are used as a part of the address, they should be included on the second line of the address.
- 3-18. (1) Affords greater control of mail. (2) Qualifies mail for domestic postal rates. (3) A uniform system for addressing mail.
- 3-19. The joint military postal activities (JMPA-ATL and JMPA-PAC).
- 3-20. The mailer.
- 3-21. Injurious article is any article, composition, or material that may kill or injure another, or damage the mail, or other property.
- 3-22. Injurious articles are generally nonmailable to, from, or between military post offices.
- 3-23. False, under certain conditions injurious articles may be entered into the mail system.
- 3-24. None; matches of all types are prohibited for mailing to military post offices and foreign countries.
- 3-25. True.
- 3-26. Intoxicating liquors may only be mailed if the alcohol content is less than .05 percent. For mailing purposes, intoxicating liquors should not be accepted in the Military Postal System.
- 3-27. Powders must be packaged in either siftproof containers or in other containers sealed in durable, siftproof outer containers.
- 3-28. The device must have the batteries removed or deactivated. The batteries may be mailed in the same parcel, but must be packed in such a way that they will not come into contact with the device.
- 3-29. 1898.
- 3-30. Size of your post office.
- 3-31. Daily.
- 3-32. USPS Publication 247.

**Answers to review questions for chapter 4.**

- 4-1. Domestic mail is mail transmitted within, among, and between the United States, its territories, and possessions; Army-Air Force post offices (APOs), fleet (Navy) post offices (FPOs); and the United Nations, New York.
- 4-2. Weight, contents, and service.
- 4-3. (1) Express Mail, (2) First-Class Mail, (3) Periodicals, (4) Standard Mail (A), (5) Standard Mail (B).
- 4-4. The measurements are taken at the greatest dimensions.
- 4-5. False.
- 4-6. USPS Label 11-B.
- 4-7. First-Class Mail.
- 4-8. Post cards must not be smaller than 3 1/2 by 5 inches.

- 4-9. First-Class zone rate (priority) mail consists of First-Class Mail weighing more than 13 ounces.
- 4-10. 70 pounds.
- 4-11. 108 inches of length and girth combined.
- 4-12. A local zone and eight others.
- 4-13. The balloon surcharge applies to articles mailed at the priority rate that weigh less than 15 pounds and the combined length and girth is from 84 to 108 inches. These articles must be charged the 15-pound rate for the appropriate zone.
- 4-14. Magazines, newspapers, and other periodicals.
- 4-15. Standard Mail (B).
- 4-16. The complete mailing address and return address including ZIP Codes.
- 4-17. 70 pounds.
- 4-18. USPS Postal Bulletin (Conditions Applied to Mail Addressed to Military Post Offices Overseas).
- 4-19. 108 inches.
- 4-20. You must determine if the parcel is machinable or nonmachinable.
- 4-21. A discount is given using the current intra-BMC discount rate chart.
- 4-22. Books, film and microfilm, test materials, printed music, all sound recordings, manuscripts for books.
- 4-23. Special Standard Mail and SAM or PAL if the customer paid for this service, above the address.
- 4-24. All mail.
- 4-25. False; all mail entering the United States is subject to customs examination.
- 4-26. The mailer.
- 4-27. The mailer.
- 4-28. The military postal clerks will ensure that the correct customs declarations are attached to parcels presented for mailing and the mailer has a valid identification card.
- 4-29. PS Form 2976-A and PS Form 2976-E (customs envelope).
- 4-30. PS Form 2976-A.
- 4-31. Because of misleading, incomplete, or inaccurate information listed on the customs declaration.
- 4-32. True.
- 4-33. \$100 from outside of U.S. territory and \$200 from Guam, American Samoa, and the Virgin Island.

**Answers to review questions for chapter 5.**

- 5-1. Certified mail provides the mailer a receipt at the time of mailing and a record of delivery is kept at the post office of address.
- 5-2. First-Class or priority mail.
- 5-3. None; insurance is not available for certified mail.

- 5-4. True.
- 5-5. Postal insurance is a service that customers may purchase to reimburse them for loss or damage that may occur to an article after it has been mailed.
- 5-6. True.
- 5-7. Domestic Mail Manual.
- 5-8. PS Form 3813.
- 5-9. PS Form 3813-P.
- 5-10. PS Form 3817, Certificate of mailing.
- 5-11. Priority Mail or Standard Mail (B).
- 5-12. Above the delivery address and to the right of the return address.

**Answers to review questions for chapter 6.**

- 6-1. International mail.
- 6-2. International Mail Manual.6-3. Index of Countries and Localities. 6-4. Postal Union, Parcel Post, and Express Mail International Service (EMIS).
- 6-5. LC mail (letters, letter packages, post cards, and aerogrammes) and AO mail (regular printed matter, books, sheet music, newspapers, magazines, matter for the blind, and small packets).
- 6-6. True.
- 6-7. Registered mail.
- 6-8. Light in color, rectangular in shape, and a minimum size of 3 1/2 inches by 5 1/2 inches, and constructed of paper strong enough to withstand normal handling.
- 6-9. Printed matter, matter for the blind, and small packets.
- 6-10. True.
- 6-11. Bright red.
- 6-12. PS Label 19-A, PAR AVION<sup>3</sup>/<sub>4</sub>Airmail, or PS Label 19-B, Air Mail Par Avion.
- 6-13. 3 1/2 inches by 5 1/2 inches.
- 6-14. Aerogrammes are air letter sheets that can be folded into the form of an envelope and sealed.
- 6-15. None; matter for the blind sent surface international mail has no charges.
- 6-16. False.
- 6-17. The Country Conditions for Mailing section of the Individual Country Listings.
- 6-18. Canada and Switzerland.
- 6-19. PS Form 2976, and PS Form 2976-A.
- 6-20. Customs Form CF-3419-A.
- 6-21. Appropriate accountable postmaster.
- 6-22. PS Form 6019 (modified).
- 6-23. None; there are no provisions to prepay customs charges.
- 6-24. Parcel post.6-25. PS Form 3813P, Receipt for Insured Mail, Domestic<sup>3</sup>/<sub>4</sub>International.
- 6-26. PS Form 2865, Return Receipt for International Mail.

**Answers to review questions for chapter 7.**

- 7-1. (1) Mail was placed in collection boxes or in mail drops in post office; (2) addressed to post offices to which it cannot be safely transported; (3) improperly prepared; (4) article consists of two or more items that are tied or fastened together.
- 7-2. Declared value of the article presented for mailing.
- 7-3. \$25,000.
- 7-4. A negotiable item is any instrument that can be exchanged for cash or goods without the signature of the bearer. A nonnegotiable item requires a bearer's signature in order to exchange them for cash or merchandise.
- 7-5. False; postal employees or military postal clerks are not permitted to assist in the preparation or sealing of mail to be registered.
- 7-6. True.
- 7-7. Clear tape and masking tape.
- 7-8. An article is considered as registered when a receipt (PS Form 3806) has been issued.
- 7-9. By postmarking all sides and flaps with an APDS.
- 7-10. Twice, once on each side at the crossing of the upper and lower flaps.
- 7-11. Secret.
- 7-12. To provide the security required for classified material, and official and personal mail.
- 7-13. Scheduled U.S. commercial, passenger nonstop flights; all cargo aircraft; AMC aircraft; surface transportation as directed; or Navy military aircraft.
- 7-14. PS Form 3877.
- 7-15. True.
- 7-16. Separating the pieces by destination.
- 7-17. Any hole renders the equipment unusable for registered mail.
- 7-18. PS Form 3854.
- 7-19. True.
- 7-20. True.
- 7-21. The letter S.
- 7-22. Replenishment at Sea Instructions (NWP 4-01).
- 7-23. Whether or not the damaged registered article is personal or official. If depredation or compromise is suspected.
- 7-24. PS Form 3826.
- 7-25. Enter the received articles registered number on the bill and coupon with a note of explanation, immediately contact the dispatching activity by phone, E-mail, or naval message, and return the coupon portion of the bill to the dispatching activity.
- 7-26. True.
- 7-27. True.
- 7-28. 5 days.
- 7-29. True.

7-30. 2 years.

7-31. Registry clerk.7-32. Three-position, changeable combination padlock.

**Answers to review questions for chapter 8.**

8-1. 1860.

8-2. True.8-3. Single, sheets, books, coils.

8-4. 100.

8-5. Books of stamps are sold for protection and convenience.

8-6. 100.

8-7. True.

8-8. Regular (Definitive) stamps, commemorative stamps, and special stamps.

8-9. \$.01 and \$5.

8-10. For the observance of historical events, to honor noted persons, and to emphasize topics of national importance or interest.

8-11. Aerogrammes, stamped cards, and stamped envelopes.

8-12. Stamp or cash drawers are used to hold the window clerk's stamp stock and cash, and to keep the stock out of reach and sight of customers.

8-13. When you walk away from your stamp stock, lock it up.

8-14. Postal clerks can be held liable for postal losses when they do not comply with handling and storing instructions.

8-15. \$25 per person.

8-16. OPNAVINST 5112.6.

8-17. Commanding officer.8-18. Weekly.

8-19. \$250 (including the \$50 change fund).

8-20. Monthly or when the total command's accumulated cash amounts to 25 percent of total fixed credit.

8-21. PS Form 17.

8-22. PS Form 3295.

8-23. \$500.

8-24. Postage meter head and meter base.

8-25. \$99.99.

8-26. Ascending and descending.

8-27. PS Form 3602-PO.

8-28. The key is used to lock the meter when the meter is not under personal supervision of the operator.

8-29. True.

8-30. Money order service means issuing and cashing domestic money orders, remittance of money order funds, and the preparation and submitting of money order reports.

8-31. Money order, voucher, customers receipt, and 2 carbons.

- 8-32. The first 10 numbers.
- 8-33. PS Form 17.
- 8-34. 45 days.
- 8-35. An emergency requisition for blank money orders should be requested by sending a message to the appropriate FLTCINC postal officer with info copy to MPSA.
- 8-36. Each package contains 100 blank money order forms.
- 8-37. DD Form 885, Money Order Control Record.
- 8-38. Setting the date.
- 8-39. True.
- 8-40. Module S of the DMM.
- 8-41. False. A fee is charged for each money order issued.
- 8-42. The money order must be spoiled.
- 8-43. No fee is charged. The customer must complete the money order and endorse it on the reverse side. The customer will then turn over the money order and customer receipt to the money order clerk. Then the money order clerk will issue a new money order for the same amount as the original money order.
- 8-44. Indefinite.
- 8-45. The customer's signs the money order above the words ENDORSEMENT SIGNATURE, and the Postal Clerk stamps the money order with the APDS and initials it.
- 8-46. At the end of each business day on which money orders were sold.
- 8-47. PS Form 6019.
- 8-48. One original and two copies.
- 8-49. Two.
- 8-50. Three.
- 8-51. True.
- 8-52. Section III.
- 8-53. Remarks section.

**Answers to review questions for chapter 9.**

- 9-1. An individual designated by proper authority to perform mail-handling duties, but who does not operate a mailroom.
- 9-2. A room or enclosure with proper security that serves as a place for unit mail clerks to handle, process, and deliver mail.
- 9-3. True.
- 9-4. Duplicate keys and copies of safe combinations must be sealed in separate duplicate key envelopes, endorsed to indicate contents, and kept in a safe controlled by the commanding officer or a designated representative.
- 9-5. Commanding officer.
- 9-6. Mail orderly system.
- 9-7. Postage-due mail will be delivered as regular mail without the collection of postage.



- 9-8. PS Form 3883.
- 9-9. PS Form 3849.
- 9-10. PS Form 3849.
- 9-11. Postmark all missent letters with the date of receipt on the back and endorse "Missent to MPO \_\_\_\_", then forward the letter to the correct address with the next outgoing dispatch.
- 9-12. The letter should be endorsed ADDRESSEE NOT AUTHORIZED MPO PRIVILEGES and returned to sender.
- 9-13. Make every effort to match the cash with the mailing container. If not successful then forward by registered USPS mail to the appropriate accountable postmaster.
- 9-14. DD Form 2273.
- 9-15. In the same manner as domestic mail.
- 9-16. True.
- 9-17. To determine the adequacy of mail service and to assist in cases of complaints or investigations.
- 9-18. The processing and makeup of mail.
- 9-19. Crew's living quarters, general mess, library, CPO mess, wardroom, or any other area convenient for crewmembers.
- 9-20. At high-traffic areas such as BEQs, BOQs, galley, housing areas, and outside, in front of the post office.
- 9-21. Sheet metal.
- 9-22. A GSA, three position-tumbler, series-type lock or any three position-tumbler type lock.
- 9-23. The key cannot be removed until the lock is secured.
- 9-24. USPS Item D1175B.
- 9-25. Business reply mail, some types of official mail, FREE mail, certain matter for the blind or handicapped, keys and identification cards being returned to owners.
- 9-26. Endorse the letter POSTAGE DUE \_\_\_\_, and enter the amount due, and process for dispatch with other mail.
- 9-27. The letter will be endorsed POSTAGE DUE \_\_\_\_, the special service label will be attached; and the special service fee will be included in the postage-due amount. This does not apply for registered or Express Mail.
- 9-28. True.
- 9-29. True.
- 9-30. By facing the mail you are placing each one in a stack with the address side up and the stamps pointing to the right.
- 9-31. All mail.
- 9-32. USPS.
- 9-33. Five.
- 9-34. Approximately 4 inches.
- 9-35. 600.
- 9-36. True.

- 9-37. OSPs are parcels that are not placed in pouches because of size, weight, nature, or content.
- 9-38. 50 pounds.
- 9-39. Slide label.
- 9-40. USPS HBK T-7.
- 9-41. True.
- 9-42. Reduces the number of pouches or trays for one destination allowing for a more expeditious mail delivery system.
- 9-43. Military mail is any domestic or international mail that bears a military address or return address and at some stage in its transit is in the possession of the Department of Defense.
- 9-44. Airlift, sealift, and land transportation.
- 9-45. United States commercial air carrier.
- 9-46. After all other classes of mail have been accepted, PAL and SAM should be tendered.
- 9-47. Outside mail (OSM) or registered mail.
- 9-48. PS Form 2942-A (AV-7).
- 9-49. The original and four copies to the air carrier representative, one copy retained in MPO files, one copy to Supervisor (IAMRU, Dulles).
- 9-50. Beginning with number 1 on the first dispatch of each month.
- 9-51. DD Form 1384.
- 9-52. OPNAV Form 5110/9.
- 9-53. True.
- 9-54. PS Form 2759.
- 9-55. Report by naval message the following information, the nature of the error, any actions taken to correct the error, and recommendations that would prevent recurring errors.

**Answers to review questions for chapter 10.**

- 10-1. True.
- 10-2. By keeping family members informed of probable mail interruptions or delays by including this information as a part of command's family-grams, holding predeployment briefings, and notices in the plan of the day.
- 10-3. PS Form 4314-C, Consumer Service Card.
- 10-4. Four.
- 10-5. Used to process inquiries for certified mail and domestic ordinary mail.
- 10-6. Postal Operations Manual (POM).
- 10-7. To recover the value of an item if it becomes lost or damaged.
- 10-8. Sender.
- 10-9. 45 days after the date of mailing.
- 10-10. Evidence of insurance, evidence of value, and proof of loss or damage.
- 10-11. By sending PS Form 3760 to the sender.
- 10-12. PS Form 673.
- 10-13. PS Form 542.
- 10-14. PS Form 2855.
- 10-15. PS Form 6401.

**Answers to review questions for chapter 11.**

- 11-1. To assist you in delivering mail to personnel and in forwarding or otherwise disposing of mail addressed to those persons no longer at your command.
- 11-2. All Navy commands are required to maintain a mail directory file of all personnel receiving mail through the activity.
- 11-3. OPNAV Form 5110/5, Notice of Change of Address.
- 11-4. Alphabetical order by last name.
- 11-5. 12 months after the individual has transferred on PCS orders or 3 months after person left from TAD assignment of 6 months or less.
- 11-6. Not larger than 1 1/2 by 1 1/2 inches.
- 11-7. 15 days.
- 11-8. Weekly.
- 11-9. 15 days.
- 11-10. True.
- 11-11. PS Form 3579.
- 11-12. The wrapper and label of the catalog should be removed and destroyed; the catalog then should be given to an authorized customer or placed in the post office lobby.
- 11-13. Department of the Navy Corrections Manual (SECNAVINST 1640.9).
- 11-14. Mail should be endorsed ADDRESSEE NOT AUTHORIZED MPO PRIVILEGES and returned to mailer.
- 11-15. As waste.
- 11-16. (1) MISSING, (2) KILLED IN ACTION, (3) WOUNDED.
- 11-17. 60 days after decommissioning.

**Answers to review questions for chapter 12.**

- 12-1. USPS should be used to the maximum extent.
- 12-2. Respective military service.
- 12-3. Military service.
- 12-4. PS Form 1590.
- 12-5. A 3-month level.
- 12-6. Used to account for each USPS supply item. PS Form 1586 will reflect the USPS item number, unit of issue, minimum and maximum supply levels, balance on hand, quantity on hand, quantity received, and quantity issued.
- 12-7. Postal supply clerk.
- 12-8. With the number 1 on 1 October each year.
- 12-9. 10-digit access code and FEDSTRIP number.
- 12-10. PS Formx DDD.
- 12-11. Electrical message.
- 12-12. A shipping order is a USPS computer printout invoice indicating action taken by the Distribution Center.

- 12-13. True.
- 12-14. PS Form 1567.12-15. PS Form 1578-B.
- 12-16. PS Form 1957-C and 1957-D.
- 12-17. PS Form 7380.
- 12-18. True.
- 12-19. Your supply department.

**Answers to review questions for chapter 13.**

- 13-1. Official mail is any letter, publication, parcel, or other mailable item relating exclusively to the business of the U.S. Government.
- 13-2. The overall goal of the NOMCCP is to reduce official mail costs.
- 13-3. OMMs must be an E-6 or above, or a DOD civilian GS-6 or higher.
- 13-4. Standard Mail (B).
- 13-5. Express Mail shall be used only when it is the most cost-effective way to accomplish a mission within time, security, and accountability constraints.
- 13-6. Red.
- 13-7. Penalty mail.
- 13-8. MPOs are authorized to use USPS penalty mail when sending USPS business items or correspondence.
- 13-9. Postage will not be placed on USPS penalty mail.
- 13-10. The size of your unit or command.
- 13-11. Daily Stamp Usage Worksheet.
- 13-12. NAVSUP Form 5218/2.
- 13-13. True.
- 13-14. Inspections should be conducted at least every 3 years.
- 13-15. NAVSUP Form 5218.
- 13-16. True.
- 13-17. Preparation and processing of mail.
- 13-18. False.

**Answers to review questions for chapter 14.**

- 14-1. Audits, reports, and inspections.
- 14-2. True.
- 14-3. Monthly, quarterly, and special.
- 14-4. Postal officer.
- 14-5. DOD Postal Manual Volume I, and Navy Postal Instruction.
- 14-6. A \$500 fixed credit has a tolerance level of \$10.00.
- 14-7. During the monthly audit.
- 14-8. PS Form 3294.
- 14-9. COPE or MPC.

- 14-10. Provides management with facts used to direct the day-to-day operation of the MPS and to answer congressional or other official inquiries.
- 14-11. Quarterly.
- 14-12. 10th of the month following the end of each quarter.
- 14-13. CINCLANTFLT, CINCPACFLT, and CINCUSNAVEUR.
- 14-14. Messages.
- 14-15. PNAs report information on matters directly affecting mail movement.
- 14-16. There is no specific format used when submitting PNAs.
- 14-17. Any unit holding mail for other units.
- 14-18. The commanding officer.
- 14-19. 72 hours.
- 14-20. Administration, financial, supply, operations, and records.
- 14-21. Commanding officer.
- 14-22. MPSA.
- 14-23. ASM.
- 14-24. Annually.



## APPENDIX II

# POSTAL TERMS, ABBREVIATIONS, AND ACRONYMS

You should be aware that most of the publications used by postal clerks have lists of terms, abbreviations, and acronyms defined in an appendix. The U.S. Postal Service (USPS) and the U.S. Navy (USN) use these abbreviations in postal messages and correspondence on a daily basis. Along with terms, abbreviations, and acronyms, we also use many United States and international cities, port, airport, and air carrier codes (usually three-letter codes) to get the mail transported to its destination(s). There are also numeric codes assigned to various air carriers. In addition to the terms, abbreviations, and acronyms we will show in this appendix you may find additional postal terms, meanings, abbreviations, ZIP Codes, and acronyms in the following publications:

USPS Handbook T-7, Distributing, Dispatching, and Transporting Military Mail by Air

USPS Publication 32, Glossary of Postal Terms

USPS Publication 52, Hazardous, Restricted, and Perishable Mail, Appendix D

USPS Publication 65-A, National Five-Digit ZIP Code and Post Office Directory

USPS Publication 223, Directives and Forms Catalog

USPS Publication 247, Supply and Equipment Catalog

DOD Official Mail Manual, DOD 4525.8-M, Appendix A

Department of the Navy Official Mail Management Instruction, OPNAVINST 5218.7B

Department of the Navy Postal Instructions, OPNAVINST 5112.6, Appendix D

DOD Postal Manual, DOD 4525.6-M Volume I

DOD Postal Manual, DOD 4525.6-M Volume II, Appendix A

**ACCOUNTABLE MAIL**—Mail that requires the signature of the addressee or addressee's agent upon receipt to provide proof of delivery or indemnification for loss or damage. This includes Express Mail and special service mail such as certified mail, collect on delivery, insured mail for more than \$50, registered mail and return receipt for merchandise.

**ACCOUNTABLE OR SERVICING POSTMASTER**—A U.S. Postal Service (USPS) postmaster where a military postal activity receives accountable paper (New York or San Francisco).

**ACCOUNTABLE MATERIALS**—Certain items of inherent monetary value. These include postal items such as aerogrammes, international reply coupons, postage stamps, philatelic products, stamped envelopes and postal cards, blank postal money order forms, or any unsold item awaiting destruction. These also include service items provided to the general public on behalf of certain federal agencies such as migratory-bird hunting and conservation stamps.

**AERIAL PORT**—An airfield that has been designated for the sustained air movement of personnel and material and to serve as an authorized port for entrance to or departure from the country in which located.

**AEROGRAMMES**—(French) A letter-size sheet of lightweight paper that folds into an airmail envelope for correspondence to other countries.

**AREA MAIL COORDINATOR**—Command responsible for coordinating intra-theater routing from mobile units in its area of responsibility.

**AUDIT**—An official action taken to examine and verify the accountability of the person(s) charged with custody of postal effects maintained in connection with the operation of a military post office (MPO).

**BACKSTAMP**—To mark the back of a mailpiece with a postmarking or canceling device to show that the piece was received, dispatched, or missent.

**BUNDLE**—Two or more packages secured together as a single unit. They may be placed on a pallet or prepared as a bedloaded bundle (outside the mail sack) only when such preparation is approved by the USPS. Also, for palletization, a group of packages. To band or tie together a group of packages to be handled as a single unit.

**CACHET**—In philately, a printed decoration on mail matter (such as a design or inscription), often referring to the new postage stamp on a first day cover. The design can be hand-created, printed, rubber-stamped, or pasted, usually on the front left side of the envelope.

**CAPITAL EQUIPMENT**—USPS equipment with a service life over 1 year, costing \$3,000 or more.

**CASE**—A piece of equipment that contains separations into which clerks or letter carriers sort letters, flats, or irregular parcels. To sort mail into a case.

**COMMEMORATIVE STAMP**—A postage stamp that depicts the cultural and historical heritage of the United States (for example, important people, events, places, or special subjects of national appeal or significance). This type of stamp is usually issued at the prime (or common current) rate, is printed in limited quantities, is typically large and colorful, and is sold for a limited time.

**CONSOLIDATED MAILROOM**—A mailroom that serves several designated organizations.

**CONTRABAND**—Matter prohibited by law from entry into the United States, U.S. possessions, or U.S. territories, or U.S. military installations in foreign countries.

**COUPON**—That part of a manifold registry bill separated by perforations used to notify the dispatching activity of any errors in the dispatch.

**CUSTOMS DECLARATION**—U.S. Postal Service (USPS) forms required on dutiable parcels mailed from overseas locations and to international addresses.

**DEAD MAIL**—Matter deposited in the mail that is or becomes undeliverable as addressed and cannot be returned to sender from the last office of address. The matter may be nonmailable, the sender may be unknown, or the mail class does not provide for return service.

**DEPREDAATION**—The term used by the Inspection Service for robbery or pilfering of funds from the mail.

**DIRECTORY MAIL**—A general term used for all classes of undeliverable domestic and international mail.

**DIRECTS**—A bundle or pouch of mail addressed to a single unit, ship, city, state, firm, or agency.

**DISPATCHING OFFICE**—Activity where mail was dispatched from.

**DOMESTIC AIR CARRIER**—Aircraft owned and operated by American companies. Domestic air carriers are used to transport military mail.

**DOMESTIC MAIL**—Mail transmitted within, among, and between the United States, its territories and possessions, Army/Air Force Post Offices (APOs) and Fleet Post Offices (FPOs), and mail for delivery to the United Nations, NY. Mail exchanged between the United States and the Freely Associated States is also treated as domestic mail. It is classified by size, weight, content, service, and other factors.

**EXAMINATION**—The process of scrutinizing personal property, parcel mail, and other Department of Defense (DOD) cargo including the physical openings of baggage, parcels, cartons, and containers,



the disassembling of articles for determining contents, or the physical search of Department of Defense (DOD) personnel and sponsors for contraband.

**FACE**—The side of a mailpiece with the delivery address. To arrange mail in a uniform orientation; that is, with the delivery address facing forward and the postage stamp, meter stamp, or permit imprint positioned in the upper-right corner.

**FINANCIAL SERVICE**—Availability to patrons of stamp stock; registered, certified, and insured service; and money order service.

**FIXED CREDIT**—A fixed amount of monetary credit extended to a custodian of postal effects (COPE) or other Postal Clerks for conducting financial services and for ordering stamps and stamped paper from the U.S. Postal Service (USPS).

**FLAT**—A general term for flat-size mail, so called because the large mail is sorted without bending it so that the mail remains flat.

**FLEXIBLE CREDIT**—An initial amount of credit extended to a custodian of postal effects (COPE) or a postal finance officer (PFO) by the U.S. Postal Service (USPS) for ordering accountable paper. A stamp sale remittance reduces the amount of credit, while stamp requisitions increase the credit.

**FOREIGN AIR CARRIER**—Aircraft owned and operated by foreign companies or foreign governments of individual countries. Used to transport ordinary military mail (less OSM and registered mail).

**FREE MAIL**—Letter mail, post cards, postal cards, and sound recordings or video's having the nature of personal correspondence mailed by military personnel in a combat zone or while hospitalized as a result of injury or disease incurred while serving in a combat zone when designated by the President.

**GENERAL DELIVERY**—An alternate delivery service that allows customers with proper identification to pick up mail at post offices. Provided primarily at offices without letter carrier delivery or for transients and customers who do not have a permanent address or who prefer not to use post office boxes.

**INDEMNITY**—An amount paid by the U.S. Postal Service (USPS) on presentation of a claim and proof of loss or damage to registered or insured mail as an adjustment or payment for loss or damage.

**INDICIA**—An imprinted designation on a mailpiece that denotes postage payment (for example, a permit imprint in place of a postage stamp or meter stamp).

**INSPECTION**—The detailed observation of personal property, letter and parcel mail, and other Department of Defense (DOD) cargo, noting their markings and outer physical characteristics, and the oral questioning of Department of Defense (DOD) personnel and their sponsors to determine the potential for customs violations.

**INTERNATIONAL EXCHANGE OFFICE (IEO)**—A post office or airport mail center/facility (AMC/F) authorized to exchange international mail and military mail, both air and surface, with another country.

**INTERNATIONAL MAIL**—Mail originating in one country and destinating in another. It is classified as Postal Union Mail (that is, letters and cards (LC) and other articles (AO)), postal parcels, and Express Mail International Service.

**INTERTHEATER MAIL**—Mail addressed between theaters exclusive of that between the continental United States (CONUS) and overseas (OCONUS) theaters. Example: Mail from FPO AE 09XXX to FPO AP 96XXX.

**INTRANSIT MAIL**—All mail, other than working mail, that is received into a postal facility for re-dispatch intact to another postal activity.

**INTRATHEATER MAIL**—Mail addressed within a theater of operation. Example: Mail from FPO AE 09XXX to FPO AE 09XXX.

**INVESTIGATING OFFICER**—A commissioned officer, warrant officer, or senior enlisted person (E-7 through E-9) appointed by a commander to review and conduct investigations, establish pecuniary liability, and report findings and recommendations within the appointing order.

**IRREGULARITIES (CARRIER)**—Failure by serving carriers to comply with performance standards established by the U.S. Postal Service (USPS).

**KILLER BARS**—The parallel lines that extend to the right of the circular postmark for canceling the postage stamp so that it cannot be reused. The lines are part of most standard machine and hand-stamped cancellations.

**MAIL ADDRESS ONLY (MAO)**—An APO or FPO number serving as a routing indicator for mail separation and transportation routing purposes only.

**MAIL CLERK**—An individual designated by proper authority to perform mail duties in association with the operation of a unit mailroom (UMR) or a postal service center (PSC) that is not considered a section of a military post office (MPO).

**MAIL CONTROL ACTIVITY (MCA)**—A civilian or military facility handling mail; such as, an aerial mail terminal (AMT), airport mail facility (AMF), bulk mail center (BMC), fleet mail center (FMC), military mail terminal (MMT), or postal concentration center (PCC).

**MAIL COVER**—A record of information on the outside (cover) of any mailpiece. It is kept to locate a fugitive, protect national security, or obtain evidence of a crime punishable by a prison term exceeding 1 year. This record is one of the few ways information on mail may be disclosed outside the USPS, and its use is lawful only if authorized by postal regulations.

**MAIL DIRECTORY**—An alphabetical listing by name of individuals served, due to arrive, or departed within the past year. Inside the United States, mail directories are maintained by military units to process undeliverable military mail for personnel served in transit or on temporary duty status. Outside the United States, mail directories are maintained by units, military post offices (MPOs), and central postal directories to process undeliverable military mail for personnel served.

**MAIL DIRECTORY SERVICE**—A search of mail directory files for the name of the addressee of undeliverable mail and endorsing each piece to show a forwarding address or reason for nondelivery.

**MAIL MAKEUP**—To separate and group mail for dispatch.

**MAIL MANIFEST**—A document transferring mail to a postal activity or into a mail transportation system. For example: DD Form 1384, Transportation Control and Movement Document.

**MAIL ORDERLY**—An individual designated by proper authority to perform mail-handling duties that are limited to collection and delivery of non-accountable mail from mailrooms and post offices.

**MAIL PROCESSING**—Canceling and sorting mail so it can be sent from the post office. All subfunctions that accommodate these two basic steps, including in and/or out movement, are part of the processing function.

**MAILROOM**—A facility or area operated by the Department of Defense (DOD) or civilian agency for the receipt and delivery of mail for military units or other authorized personnel and agencies.

**MAIL ROUTING AUTHORITY**—Mail routing message or individual requesting mail movement of any given unit.

**MAIL ROUTING GUIDE**—Guide published by Joint Military Postal Activity - Atlantic (JMPA-A) or Joint Military Postal Activity - Pacific (JMPA-P) that lists all U.S. Navy (USN) ships and activities operating within its area of responsibility.

**MANAGED MAIL TRAY (MM)**—A stackable cardboard or plastic container used with and enclosing cardboard sleeve. It is used to transport letter-size mail between selected postal facilities or between a mailer’s mailroom or plant and a specific postal facility.

**MILITARY MAIL**—Domestic mail and international mail that bear a U.S. military delivery address or return address and that, in some stage of its transmission, is in the possession of the Department of Defense (DOD).

**MILITARY MAIL TERMINAL**—A Department of Defense (DOD) facility usually operated by the Army (USA) to send, receive, combine, distribute, transfer, dispatch, and control military mail (usually Presorted Standard Mail A, Standard Mail B, and non-time value Periodicals) to, from, and in overseas (OCONUS) areas.

**MILITARY POST OFFICE (MPO)**—A branch of a designated USPS civilian post office, which falls under the jurisdiction of the postmaster of either New York or San Francisco. It is operated by the Department of Defense to serve military personnel overseas or aboard ships where the USPS does not operate and a military situation requires the service. It may be either an Army post office (FPO) that serves the Army or Air Force or a fleet post office (FPO) that serves the Coast Guard, Navy, or Marine Corps.

**MIXED CITY**—A dispatch of mail for more than one zone in a city.

**MIXED STATES**—A dispatch of mail for several states.

**MONEY ORDER VERIFICATION OFFICER**—A person (E-7 or above) designated by the commanding officer to perform daily audits of money order business.

**MONIES AUDIT BOARD**—Consists of personnel designated in writing by the commanding officer to perform monthly audits of the post office.

**NEGLIGENCE**—The failure to act as a reasonably careful person would act under like conditions. Failure to comply with existing postal laws or procedures may be evidence of negligence.

**NONMAILABLE ARTICLES and SUBSTANCES**—Matter that may not, by law, be sent through the mail. This includes certain hazardous matter, restricted matter, or perishable matter.

**OFFICIAL MAIL**—Mail authorized by federal law to be sent by government officials without postage prepayment. It includes franked mail sent by members of Congress and penalty mail sent by U.S. Government agencies.

**ORDINARY MAIL**—Any class of domestic mail that is accorded standard dispatching and handling. This excludes Express Mail and Priority Mail as well as mail with a special service (for example, certified mail, collect on delivery, registered mail, and special handling).

**ORIGIN AIRPORT**—Air facility at which a mail dispatch is actually performed.

**PARENT UNIT**—A primary military post office (MPO) that may operate integral subordinate units.

**PECUNIARY LIABILITY**—A personal, joint, or corporate monetary obligation to make good any lost, damaged, or destroyed property resulting from fault or neglect. It also may result under conditions stipulated in a contract or bond.

**PENALTY MAIL**—Official mail sent without postage prepayment by officers of the executive and judicial branches of the U.S. Government, by departments and agencies of the U.S. Government, and by specifically authorized individuals. The term comes from the endorsement “Penalty for Private Use” printed on the mail.

**PHILATELY**—The collection and study of postage stamp and postal stationary for pleasure and profit.

**POSTAGE METER**—A mechanical or electromechanical device that can print one or more denominations of an authorized postage indicia. It is available for lease only from designated manufactures.

**POSTAL AGREEMENT**—An agreement between the U.S. Postal Service (USPS) and the Department of Defense (DOD) concerning guidelines for providing postal services on military installations.

**POSTAL CARD**—A blank mailing card sold by the USPS (as distinguished from a commercial card) with a printed or impressed postage stamp.

**POSTAL COMPLAINT**—An expression of dissatisfaction, discontent, disappointment, or resentment concerning any postal product service, or postal personnel.

**POSTAL CONCENTRATION CENTER (PCC)**—A U.S. Postal Service (USPS) facility operated at a continental U.S. (CONUS) gateway city for concentrating and dispatching overseas (OCONUS) destined military mail and for receiving and processing continental U.S. (CONUS) destined military mail. A postal concentration center (PCC) can be a separate facility or part of an aerial mail terminal (AMT) or bulk mail center (BMC).

**POSTAL EFFECTS**—All accountable paper stock, funds, and equipment entrusted to the Department of Defense (DOD) by the U.S. Postal Service (USPS) for military postal operations. Postal Effects include postage stamps, stamped paper, and funds derived from their sale; blank money order forms, paid money orders, and money order funds; fees collected for special mail services; and capital or sensitive equipment furnished by the U.S. Postal Service (USPS).

**POSTAL FINANCE OFFICER (PFO)**—A custodian designated to maintain wholesale quantities of postage stamps, stamped paper, and blank money order forms for issue to custodian of postal effects (COPEs) for the operation of military post offices (MPOs).

**POSTAL INQUIRY**—A request for postal information.

**POSTAL OFFICER**—An individual designated by the commanding officer for the overall supervision of the command's postal operations.

**POSTAL SERVICE CENTER (PSC)**—A facility through which mail is delivered to authorized individuals by delivery receptacles without regard to unit of assignment.

**POSTAL ZONE**—A geographic measurement that is based on the distance between units of the earth's area 30 minutes square. This data is generally used when computing postage on zone-rate mail (such as Parcel Post) between USPS facilities including military post offices.

**POSTMARK**—A postal cancellation imprint on letters, flats, and parcels. The imprint shows date and the name, state, and ZIP Code of the post office or sectional center facility that accepted custody of the mailpiece.

**POUCH**—Mailbag identified by the leather strap-locking device.

**PROSPECTIVE RELIEF**—An individual designated as the alternate postal clerk. The alternate postal clerk should be available to carry out postal functions in the absence of the primary postal clerk.

**RECEPTACLE**—A no-fee box used to deliver mail in postal service centers (PSCs), unit mailrooms (UMRs), and other authorized places. A key or combination lock is used to control delivery to the proper addressee.

**REGISTRY CAGE**—A storage area for large quantities of registered mail. The area must meet requirements established by the military postal service agency (MPSA).

**RESERVE CUSTODIAN**—An individual designated in writing by command authority to control and safeguard postal effects that are the responsibility of the designated custodian of postal effects (COPE).

**RESPONSIBLE COMMANDER**—A designated officer exercising control over a specified level of postal operations determined by each major command (MACOM).

**RETROGRADE MAIL**—Mail destinating in the United States.

**SACK**—A container generally used to transport flat-size mail, parcels, and loose pack mail. It is made of sewn fabric (usually nylon, polyester, canvas, or plastic with an opening at one end) and is closed with a draw cord and fastener. In mail processing or dispatch functions, to place mail in a sack.

**SERVICE STANDARDS**—A stated goal for service achievement for each mail class.

**SERVING POSTAL ACTIVITY**—The military or civilian post office or unit that provides postal support.

**SPECIAL ROUTING**—Mail routing that requires special or unusual arrangements by the mail routing activity.

**STAMP VENDING MACHINE (SVM)**—A vending machine that has multiple modules capable of dispensing varying quantities of stamps from a coil from each module.

**STANDPOINT SCHEME**—A scheme used by an international exchange office for the labeling and routing of international mail.

**UNIT MAILROOM (UMR)**—A room or enclosure with proper security that serves as a place for unit mail clerks to handle, process, and deliver mail.

**UNIT POSTAL OFFICER**—A member or civilian employee of the U.S. armed forces, or an employee of a civilian agency, designated by proper authority to supervise the operation of a unit mailroom (UMR).

**UNIVERSAL POSTAL UNION (UPU)**—An international postal organization that is a specialized agency of the United Nations. Its 189 member countries form a single postal territory for the reciprocal exchange of letter-post items. Its Convention establishes the common rules applicable to the international postal service and the provisions governing letter-post services.

**WORKING MAIL**—Mail received by or dispatched from a military post office (MPO) and mail that is received by a mail control activity (MCA) where mailbags are physically opened and the contents are distributed, to include bagging outside mail (OSM) when required.

**ZIP CODE**—The five-digit numerical code of which the first three digits identify the delivery area of a sectional center facility or a major-city post office serving the delivery address area. The next two (the fourth and fifth) digits identify the delivery area of an associate post office, post office branch, or post office station. All post offices are assigned at least one unique 5-digit code. ZIP Code is a USPS trademark.

**ZIP + 4 CODE**—The nine-digit numeric code, established in 1981, composed of two parts: (a) The initial code: the first five digits that identify the sectional center facility and delivery area associated with the address, followed by a hyphen; and (b) The four-digit expanded code: the first two additional digits designate the sector and the last two digits designate the segment. ZIP+4 is a USPS trademark.

#### POSTAL ABBREVIATIONS AND ACRONYMS

AA—Armed Forces Americas

AC—Actual Count

ACCT—Account

ACFT—Aircraft

ACTY—Activity

ADC—Area Distribution Center

AE—Armed Forces Europe

AGCY—Agency

AIC—Account Identifier Code

AMC—Air Mobility Command  
AMC/AMF—Airport Mail Center/Airport Mail Facility  
AMT—Aerial Mail Terminal  
AO—Autres Objets (other objects) used on international mail  
AOR—Area of Responsibility  
AP—Armed Forces Pacific  
APDS—All-Purpose Dating Stamp  
APO—Army or Air Force Post Office  
APOD—Aerial Port of Debarkation  
APOE—Aerial Port of Embarkation  
AR—Avis De Reception (return receipt) used on international mail  
ARC—American Red Cross  
ASM—Administrative Support Manual  
AWOL—Absent Without Leave  
BBM—Bulk Business Mail  
BCS—Bar Code Sorter  
BK—Book (unit of issue)  
BMC—Bulk Mail Center  
BRM—Business Reply Mail  
BX—Box (unit of issue)  
CMRS—Computerized Meter Resetting System  
COB—Close of Business  
COD—Carrier Onboard Delivery  
C.O.D.—Collect On Delivery  
CONEX—Container Express  
CONUS—Continental United States  
COPE—Custodian of Postal Effects  
CPU—Central Processing Unit  
CTN—Carton (unit of issue)  
CTUS—Customs Territory of the United States  
DBCS—Delivery Bar Code Sorters  
DECOM—Decommission  
DET—Detachment  
DMM—Domestic Mail Manual  
DOD—Department of Defense  
DON—Department of the Navy

DP—Direct Pouch  
EA—Each (unit of issue)  
EDA—Estimated Date of Arrival  
EDD—Estimated Date of Departure  
EFT—Electronic Funds Transfer  
EMMS—Express Mail Military Service  
ENTNAC—Entrance National Agency Check  
FAM—Financial Adjustment Memorandum  
FCM—First-Class Mail  
FEDSTRIP—Federal Standard Requisitioning and Issue Procedures  
FLTCINC—Fleet Commander-in-Chief  
FMC—Fleet Mail Center  
FMU—Fleet Mail Unit  
FPC—Financial Postal Clerk  
FPO—Fleet Post Office  
FSM—Flat Sorting Machine  
GAO—General Accounting Office  
GPO—Government Printing Office  
GSA—General Services Administration  
HD—Hundred (unit of issue)  
HDBK—Handbook  
HQ—Headquarters  
IAMRU—International Airmail Reporting Unit  
ICIO—International Claims and Inquiries Office  
ID—Identification  
IDS—Intra-theater Delivery Service  
IEO—International Exchange Office  
IG—Inspector General  
IMM—International Mail Manual  
IRC—International Reply Coupon  
IRT—Integrated Retail Terminal  
JAG—Judge Advocate General  
JMPA—Joint Military Postal Activity  
LAB—Label  
LC—Letters and Cards (used in international mail)  
LCM—Letter Class Mail

LOGAIR—Logistic Airlift  
LV—Leave  
MACOM—Major Command  
MAO—Mail Address Only  
MAU—Military Auditing Unit  
MCA—Mail Control Activity  
MDC—Material Distribution Center  
MDS—Mail Distribution Scheme  
MILSTAMP—Military Standard Transportation and Movement Procedures  
MM—Managed Mail Tray  
MO—Money Order  
MOA—Money Order Account  
MOB—Money Order Business  
MODIS—Military Origin Destination Information System  
MOM—Military Ordinary Mail  
MPC—Military Postal Clerk  
MPO—Military Post Office  
MPS—Military Postal Service  
MPSA—Military postal Service Agency  
MRC—Mail Recovery Center  
MRI—Mail Routing Instruction  
MRS—Merchandise Return Service  
MSC—Military Sealift Command  
MTE—Mail Transportation Equipment  
MWR—Morale, Welfare, and Recreation  
N/A—Not Applicable  
NAC—National Agency Check  
NAFI—Nonappropriated Fund Instrumentality  
NAVSUP—Naval Supply (Commander Naval Supply System Command)  
NCIS—Naval Criminal Investigative Service  
NCV—No Commercial Value  
NLT—No Later Than  
NMCS—Not Mission Capable Supply  
NOMCCP—Navy Official Mail Cost Control Program  
NOTAL—Not All  
NPO—Navy Post Office



NSN—National Stock Number  
NWA—No Witness Available  
OCONUS—Overseas  
OCR—Optical Character Reader  
OFL—Official  
OIC—Officer in Charge  
OID—Office Identification Number  
OJT—On-the-Job Training  
OL—Operating Location  
OMAS—Official Mail Accounting System  
OMCCP—Official Mail Cost Control Program  
OMCO—Official Mail Control Officer  
OMM—Official Mail Manager  
OPLAN—Operation Plan  
OPNAV—Office of the Chief of Naval Operations  
OSP/OSM—Outside Piece/Outside Mail  
PAA—Postal Assistance Advisor  
PAL—Parcel Airlift  
PAP—Postal Advisor Program  
PARS—Postal Activity Reporting System  
PB—Postal Bulletin  
PC—Postal Clerk  
PCC—Postal Customer Council  
PCC—Postal Concentration Center  
PCS—Permanent Change of Station  
PD—Pad (unit of issue)  
PFO—Postal Finance Officer  
PG—Page (unit of issue)  
PLAD—Plain Language Address Directory  
PM—Postmaster  
PMCC—Passenger Mail Cargo Coordinator  
PNA—Postal Net Alert  
PO—Post Office  
POD—Port of Debarkation  
POE—Port of Embarkation  
POM—Postal Operations Manual

POP—Postal Operating Plan  
PP—Parcel Post  
PRECOM—Pre-commissioning  
PRI—Priority Mail  
PS—Postal Service  
PSC—Postal Service Center  
PUB—Publication  
QA—Quality Assurance  
RDD—Required Delivery Date  
REG—Registered Mail  
RL—Roll (Unit of Issue)  
RNLTD—Report No Later Than Date  
SALTS—Streamlined Automated Logistics Transfer System  
SAM—Space Available Mail  
SDR—Special Drawing Rights  
SE—Set (unit of issue)  
SF—Standard Form  
SH—Sheet (unit of issue)  
SM—Service Member  
SNDL—Standard Navy Distribution List  
SOFA—Status of Forces Agreement  
SOP—Standing Operating Procedures  
SPR—Small Parcels and Rolls  
SSIC—Standard Subject Identification Code  
SSN—Social Security Number  
SVM—Stamp Vending Machine  
TAD—Temporary Additional Duty  
TCMD—Transportation Control and Movement Document  
TPO—Transfer Post Office  
TTOS—Touch Telephone Ordering System  
TYCOM—Type Commander  
UCMJ—Uniform Code of Military Justice  
UIC—Unit Identification Code  
UMR—Unit Mailroom  
UNREP—Underway Replenishment  
UPS—United Parcel Service

UPU—Universal Postal Union

USC—United States Code

USPS—United States Postal Service

VERTREP—Vertical Replenishment

VESS—Vending Equipment Sales and Services (Report)

Listed below are the two-letter state and U.S. possession abbreviations:

AL—Alabama

AK—Alaska

AR—Arkansas

AS—American Samoa

AZ—Arizona

CA—California

CO—Colorado

CT—Connecticut

DC—District of Columbia

DE—Delaware

FL—Florida

FM—Federated States of Micronesia

GA—Georgia

GU—Guam

HI—Hawaii

IA—Iowa

ID—Idaho

IL—Illinois

IN—Indiana

KS—Kansas

KY—Kentucky

LA—Louisiana

MA—Massachusetts

MD—Maryland

ME—Maine

MH—Marshall Islands

MI—Michigan

MN—Minnesota

MO—Missouri

MP—North Mariana Islands

MS—Mississippi  
MT—Montana  
NC—North Carolina  
ND—North Dakota  
NE—Nebraska  
NH—New Hampshire  
NJ—New Jersey  
NM—New Mexico  
NV—Nevada  
NY—New York  
OH—Ohio  
OK—Oklahoma  
OR—Oregon  
PA—Pennsylvania  
PR—Puerto Rico  
PW—Palau  
RI—Rhode Island  
SC—South Carolina  
SD—South Dakota  
TN—Tennessee  
TX—Texas  
UT—Utah  
VA—Virginia  
VI—Virgin Islands  
VT—Vermont  
WA—Washington  
WI—Wisconsin  
WV—West Virginia  
WY—Wyoming

## APPENDIX III

# EXAMPLE OF A POSTAL OPERATING PLAN

POSTAL OPERATING PLAN	
TABLE OF CONTENTS	
ACTIVITY: FLEET MAIL CENTER, YOKOHAMA, JAPAN	
SECTION	PAGE
1. Table of contents	1-A
a. Activity Information	2-A
b. Daily Average	3-A
2. Basic Facility Data	
a. Mail Processing Equipment	4-A
b. Facility Layout	5-A
c. Pouch/Sack Arrangement-Military Working	6-A
d. Letter Case Arrangement-Military Working	7-A
e. Flats Case Arrangement-Military Working	8-A
f. Pouch/Sack Arrangement-CONUS	9-A
3. Mail Processing Profile	
a. Volume in Pieces	10-A
b. Mailbags Processed-Working Mail	11-A
c. Mailbags Processed-In-Transit Mail	12-A
4. Mail Processing Targets	
a. Closed Mail	13-A
b. Working Mail-Incoming/Outgoing	14-A
5. Transportation	
a. Ground Transportation Schedule	15-A
b. Daily Air Dispatch Schedule	17-A
6. Special Instructions	25-A

COMFLEACT YOKOSUKA INSTRUCTION 5110.1H

Subj: STANDARD OPERATING PROCEDURES FOR YOKOSUKA POST OFFICE  
96349, IKEGO POST OFFICE 96351, NEGISHI POST OFFICE 96348, AND FLEET MAIL  
CENTER YOKOHAMA 96347

Ref: (a) Status of Forces Agreement  
(b) COMNAVFORJAPANINST 5110.1E  
(c) DoD Postal Manual 4525.6-M, Volumes I & II  
(d) USPS Domestic Mail Manual  
(e) OPNAVINST 5112.6C  
(f) OPNAVINST 5218.7B  
(g) USPS International Mail Manual  
(h) COMNAVFORJAPANINST 5000.4K  
(i) NAVCOMPT Manual Volume 4  
(j) SECNAVINST 7042.7H  
(k) EXE DIR MIL POSTAL SVC AGCY Alexandria VA 080653Z Jul 96

Encl: (1) Mailing Address for Yokosuka and Ikego Housing Area  
(2) Mailing Address for Fleet Mail Center, Yokohama and Negishi Housing Area  
(3) Mailing Addresses for Homeported Ships  
(4) Sample of Completed Notice of Change of Address Card (OPNAV 5110/5)  
(5) Designation of Mail Orderly/Clerk (CFAY 5110/2 (Rev. 4-97))  
(6) Family Member Mail Service

1. Purpose. To promulgate regulations and provide guidance in the operation and use of Fleet Mail Center (FMC), Yokohama 96347, Negishi housing post office 96348, COMFLEACT Yokosuka post office 96349, and Ikego housing post office 96351.

2. Cancellation. This instruction is a complete revision and cancels COMFLEACTINST 5110.1G; therefore, no margin notations have been included.

3. Information. Reference (a) authorized the establishment of United States Military Post Offices (MPOs) in Japan for use by members of the U.S. Armed Forces, the civilian component, and their family members. Reference (b) identifies those persons and organizations authorized to use the Navy postal service in Japan.

4. Responsibilities. Per reference (c), FMC Yokohama is designated as the major mail transportation manager for the Military Postal Activity in the Pacific theater to include Japan and the Indian Ocean. Also, FMC Yokohama has been designated by Commander in Chief, U.S. Pacific Fleet (CINCPACFLT) as the Postal Supplies and Equipment

Custodian, and as the consolidation point for all empty mail transportation equipment (MTE) in Japan. The following standards and requirements are performed:

- a. Issues basic mail distribution and transportation procedures and policies.
- b. Implements a mail movement management report.
- c. Implements a mail movement management information system, which specifies transit time standards and reports performance.
- d. Develops the standard reporting system.

e. Ensures that a single agent is designated at each mail terminal to perform specific mail management functions in addition to the physical processing of the mail.

5. Organization. FMC Yokohama is a department under Commander, Fleet Activities (COMFLEACT) Yokosuka with the Officer in Charge, (OIC) COMFLEACT Yokosuka, and Yokohama Detachment as the department head. Per reference (c), Volume, I, the following postal responsibilities are as follows:

a. Officer in Charge (OIC). Is responsible to COMFLEACT Yokosuka for the overall supervision of all command postal functions.

b. Assistant Officer-in-Charge (AOIC)

(1) Responsible to the OIC for the overall supervision of all command postal functions.

(2) Establishes and maintains liaison with foreign officials, Army and Air Force postal services, Military Sealift Command (MSC) and other agencies concerned with the handling and transportation of Navy mail, and assists CINCPACFLT in the administration and operation of the Military Postal Service (MPS). The AOIC is to ensure compliance of references (a) through (h).

c. Postal Officers (PO). E-7 or above designated by the OIC for both FMC Yokohama and Yokosuka post office. Maintains and establishes liaison with foreign officials, Army and Air Force postal services, MSC and other agencies concerned with the handling and transportation of Navy mail, and assists CINCPACFLT in the administration and operation of the MPS. Postal officer will also be present during all postal audits. The PO is to ensure operational compliance of references (a) through (h).

d. Postal Finance Officer (PFO). Personnel designated as PFO will be an E-7 or above in the postal clerk rating. An E-6 postal clerk may be designated as PFO if authorized in writing by the major command. PFO Yokohama is responsible for financial accountability of fixed credits issued to Custodians of Postal Effects (COPE), and meter remittances received by PACFLT overseas shore based MPOs. Processes requisitions for money orders and stamps providing direct support to seven shore based commands, and 17 forward deployed naval forces ships, and deployed units operating in the Northern and Western Pacific, and Indian Ocean. PFO is directed to maintain an adequate supply of stamps, stamped paper and blank money orders to support cognizant post offices. The PFO will be audited quarterly per reference (c) and the PFO Handbook. The PFO is the designated Supplies and Equipment (PS Form 1590) Custodian. A record of account will be retained on PS Form 1590 from each Navy MPO located in Japan.

e. Custodian of Postal Effects (COPE). Accountable for the flexible credit and equipment issued to the post office by the USPS. Financial responsibility includes postage stamps, stamped paper, blank money order forms, paid money orders, and funds derived from stamp and money order sales. The COPE is to ensure compliance of references (a) through (h).

f. Postal Audit Board. Will consist of the AOIC, Postal Officer, and members of the Postal Audit Board designated by COMFLEACTNOTE 1301. Personnel designated must be in pay grades E-7 and above or U.S. Civil Service equivalent. A minimum of two board members of the Postal Audit Board shall be present during all audits. All postal audits will be conducted per Chapter 12 of reference (c) and the PFO Handbook.

g. Postal Assistance Advisor and Training Program (PAATP). The PAATP in PACFLT is administered and operated by the CINCPACFLT Postal Officer. The purpose of the PAATP is to assist commanding officers in evaluating their command's daily postal operations and to provide technical training to assigned postal personnel. Specifically, the PAATP is established to accomplish the following:

(1) Provide assistance, guidance, technical training, and inspection for MPOs and mailrooms operated by the Department of the Navy.

(2) Actively solicit the involvement of commanding officers in compliance with reference (e) concerning the frequency schedule of postal assist visits every 18 months for the afloat commands and annually for ashore commands.

(3) Conduct investigations or assist, as appropriate, U.S. Postal Inspectors, Naval Criminal Investigative Service, and Judge Advocate General investigators researching irregularities regarding postal funds, mail, and administrative procedures.

h. Mail Router. The Mail Router will perform this special postal function strictly per reference (c), Volume I, Chapter 11, Part 3. In addition, the performance of this duty supports the movement of mail to and from mobile units, and the dispatch of mail according to mail-routing information from commanders of mobile units and Joint Military Postal Activities. Cutoff dates for the various classes of mail shall be planned carefully by the dispatching office and shall be based upon the transportation available, transit times, and special conditions affecting mail delivery. Close coordination between mobile units and supporting fixed MPS/USPS activities is necessary. All mail routing information will be in message format per reference (c), Chapter 11.

6. Location/Hours of Operation

a. FMC Yokohama. Located in Building S-106, North Pier, Yokohama. The FMC is a mail processing center to route, receive, consolidate, and dispatch mail for Navy and Marine units and commands in Japan, Korea, Okinawa, and mobile units of the Seventh Fleet operating in the Northern and Western Pacific, the Fifth Fleet, and the Indian Ocean. FMC Yokohama operates 24 hours a day, seven days a week, processing over 2,000,000 pounds of mail monthly. Financial services are limited to a Stamp Vending Machine in the entrance of the Military Sealift Command Headquarters building, located at North Pier.

b. Negishi Housing Post Office. Located in the Community Center, Building 19045, Negishi Heights, Yokohama.

Hours of Operation:

Services	Days	Hours
Customer Services	Monday	1100 - 1700
	Tuesday - Friday	0900 - 1700
	Saturday	0900 - 1300
	Sunday/Holidays	Closed
Family Member Mail Lobby Boxes	Monday - Sunday	24-Hour Service
Stamp Vending Machine (SVM) (Inside bldg 19045, next to theater)	Monday - Sunday	24-Hour Service
Stamp Vending Machine (SVM) (Quarter Deck, Military Sea Lift Command)	Monday - Sunday	24-Hour Service

c. COMFLEACT Yokosuka Post Office. Navy post office COMFLEACT Yokosuka is located in Building 1258, next to the Berkeley Field House and Thew Gym. Provides services in support of Seventh Fleet and Fifth Fleet deployed naval forces, 11 homeported ships, 54 tenant commands and approximately 23,000 military/civilian personnel and family members.



Hours of Operation:

<b>Services</b>	<b>Days</b>	<b>Hours</b>
Customer Services	Monday - Friday	0900-1630
	Saturday	1000-1300
	Sunday & Holidays	Closed
Base Mail Call	Monday	0930-1030
	Tuesday - Friday	0930-1030
	Saturday	1000-1300
Mail pick up for ships	Sunday & Holidays	Closed
	Monday - Friday	0630-1630
Official Mail Hand Deliveries	Saturday	1000-1300
	Sunday & Holidays	Closed
	Monday - Friday	0900-1200
Family Member Mail Lobby Boxes	Saturday, Sunday & Holidays	Closed
	Monday - Sunday	24-Hour Service
Stamp Vending Machine (SVM) (Inside Post Office DMS Lobby) (1 <sup>st</sup> Floor Fleet Recreation bldg) (Lobby of PSD)	Monday- Sunday	24-Hour Service

d. Ikego Housing Post Office. Located in the Ise Tower, Building 677, Zushi City, Ikego

Hours of Operation:

<b>Services</b>	<b>Days</b>	<b>Hours</b>
Customer Services	Monday - Friday	1100-1630
	Saturday	1000-1300
	Sunday & Holidays	Closed
Accountable and Family Member Mail Parcel Pick-up	Monday - Friday	1100-1700
	Saturday	1000-1300
	Sunday & Holidays	Closed
Base Mail Call	Monday - Friday	1100-1700
	Saturday, Sunday & Holidays	Closed
Family Member Mail Lobby Boxes	Monday - Sunday	24-Hour Service
Stamp Vending Machine (SVM) (Inside DMS Lobby)	Monday – Sunday	24-Hour Service

7. Security. Access to work areas shall be limited to those personnel conducting official business, including designated postal clerks, officers, enlisted members, and civilians on official inspections and visits. Maintenance personnel and postal work details are authorized entry when escorted and under constant surveillance by military postal personnel. Other security measures and protection of postal property and effects shall be maintained at all times per reference (c), Volume I, Chapters 9 and 13.

8. Mail bombs

a. Postal personnel should be aware that a bomb could be enclosed in either a parcel or an envelope, with outward appearance limited only by the imagination of the sender. Mail bombs have exhibited the following unique characteristics that may assist postal clerks in identifying a suspected letter or a parcel:

(1) Mail bombs may bear restricted endorsements such as **“Personal”**

(2) The addressee’s name and/or title may be inaccurate.

(3) Mail bombs may reflect distorted handwriting or the name and address may be prepared with homemade labels or cut-and-paste lettering

(4) Mail bombs may have visible protruding wires, aluminum foil, or oil stains and may emit a peculiar odor

(5) Mail bombs may have an excessive amount of postage stamps affixed.

(6) Letter bombs may feel rigid or appear uneven or lopsided.

(7) Parcel bombs may be unprofessionally wrapped with several combinations of tape used to secure the package and may be endorsed **“FRAGILE HANDLE WITH CARE “**or **“RUSH DO NOT DELAY.”**

(8) Parcel bombs may make a buzzing sound, ticking or sloshing noise.

(9) The return address listed on the article may differ from the meter or postmark of the accepting post office.

b. If a postal clerk is suspicious of a mailing and is unable to verify the contents with the addressee or sender:

(1) Do not open the article

(2) Isolate the article and evacuate the immediate area.

(3) Do NOT put the article in water or a confined space such as a desk drawer or filing cabinet.

(4) If possible, open windows in the immediate area to assist in venting potentially explosive gases.

c. If there is any reason to believe a letter or parcel is dangerous, do not take a chance, follow the above procedures and call:

**Negishi Yokohama Security Det – 242-4111**  
**CFAY Security- 243-5000**  
**CFAY EOD – 243-7190/7191 (After normal working hours,**  
**request security contact EOD)**

9. Mail Box Locations/Collection Times

a. COMFLEACT Yokosuka area. Mail pick up from all collection boxes are collected at 1300, Monday through Sunday at the following locations:

- Family member mail service box lobby section building 1258, post office (1630 last collection Monday –Friday)

- Traffic circle in front of post office
- Building 33, Transient Barracks
- Building 1475, CPO Quarters
- Building 1555, Personnel Support Detachment
- USNH Yokosuka, by emergency entrance
- Building 1556, Bachelor Officer Quarters
- Building C-39, Commander Naval Forces Japan Command Center
- Between building C-1 and C-2, COMFLEACT Yokosuka and Commander Naval Forces Japan
- Next to Port Operations, building 5203 across Fleet Recreation Center
- Next to bus stop across from Navy Lodge
- Niban #2 Tower
- Corner Gridley Lane/Green Street near Town House #83
- Between Goban #5 Tower and Rokuban #6 Tower
- Nanaban #7 Tower and Hachiban #8 Tower
- Building H-12, between NEX and Commissary Store
- In front of Afloat Training Group building 1997

b. Negishi Housing Area. Mail pick up from all collection boxes are collected at 1530 Monday through Saturday at the following locations:

- Outside of post office lobby
- Adjacent to quarters 542
- Adjacent to quarters 616
- Adjacent to quarters 678
- Adjacent to quarters 612
- BEQ/BOQ lobby

c. Ikego Housing Area. Mail pick up from all collection boxes are collected at 1530, Monday- Friday, 1230 on Saturday and no pick up on Sunday/Holidays.

- In front of post office
- In front of Navy Exchange Mini Mart
- In front of Takenoshiro town house area

10. Mailing Addresses. Incorrect, incomplete and poor address hygiene is the major causes of delay and non-delivery of mail. Personnel should notify their correspondents and publishers of their correct mailing address. To improve address hygiene, the USPS requests that all-military organization use the three-line address hygiene system to improve delivery time. This will assist the electronic bar code machine to process mail faster. For official mail, addresses on mailing labels should be typed or printed in upper case letters with no punctuation. Examples and addresses served by FMC Yokohama 96347, Negishi housing post office 96348, COMFLEACT Yokosuka post office 96349, Ikego housing post office 96351, homeported ships and units are provided in enclosures (1) through (3).

11. Authorized Users of the Navy Postal Service. Reference (b) identifies personnel and organizations authorized to use the MPS in Japan. Reference (c) states that personnel shall not act, as intermediaries for personnel or organizations not authorized to use the service. Personnel utilizing FMC Yokohama 96347, Navy post offices 96348, 96349 and 96351 will comply with this requirement. Non-compliance could result in legal or administrative action including termination of MPS privileges.

12. Unauthorized Users of Navy Postal Service. Per reference (b), paragraph 5d, "Family members of active duty members of the U.S. Armed Forces and civilian employees of agencies and organizations outlined in DoD Postal Manual whose sponsor is not stationed in Japan. Upon departure of a military or civilian member from Japan on permanent change of stations, the sponsor's family members are no longer entitled to benefits and privileges afforded by Status of Force Agreement except as outlined in paragraph 6 below (Termination of Logistic Support). Family members of active duty U.S. Armed Forces personnel who are not stationed in Japan may be served only when they are physically accompanying their active duty sponsor in Japan in an authorized travel status, including authorized leave. This privilege cannot be extended to family members of civilian employees." In addition, paragraph 6 of reference (b) states, "In unusual cases, the local area commander may approve continued benefits and privileges for up to a maximum of 90 calendar days subsequent to departure of sponsor. Request for continuation of logistical support for family members in excess of 90 days whose sponsors have departed Japan shall be forwarded to Commander U.S. Forces, Japan via COMFLEACT Yokosuka. Using lobby box numbers to undertake a business or a commercial enterprise to resell is prohibited per Appendix A, A-7 of reference (c), reference (b) and this instruction.

13. Mail Orderly System. In accordance with reference (c) Volume II, Mail Orderlies are assigned on a collateral duty basis to pickup mail from the post office, to distribute and provide delivery within the respective division, department, agency, organization, bank or exchange, and to provide directory service. Mail orderlies are responsible for mail in their custody until it is properly delivered. All pieces of mail are required to be delivered personally to the addressee. Mail will not be left in an unattended area where the possibility of theft may occur. Undeliverable mail must be returned to the post office immediately or stored in a safe place. In addition the mail orderlies are responsible for bringing back 3849's (Delivery/ Notice /Reminder/ Receipt) for personal accountable mail when their personnel are on leave, TAD etc., this will prevent accountable mail from being returned to the sender and a hold will be put on their mail. The command's mail orderly system has a direct impact on the post office's reputation for providing mail service. For this reason, individuals must be carefully selected and thoroughly trained to perform their duties in a professional manner. Personnel selected as mail orderlies must meet the following qualifications.

- a. Be a U.S. citizen, if required to handle official registered mail.
- b. The citizenship requirement for mail orderly is determined by the employing government department, agency, organization, bank or exchange. The post office will deliver mail to mail orderlies in accordance with written authorization. Copies of such authorization must be furnished to the post office for postal files.
- c. Trustworthy in character. Personnel do not qualify if any of the following items apply:
  - (1) Conviction by court-martial.
  - (2) Punishment under the Uniform Code of Military Justice involving a postal related incident within the last 12 months.
  - (3) Civil convictions other than minor traffic violations.
  - (4) Disciplined reflecting unfavorably on integrity.
  - (5) History of psychiatric disorders, alcoholism, or drug abuse. (Individual may be designated only if medical evaluation determines the condition no longer exists).
  - (6) Relieved of postal duties for cause.

d. The number of mail orderlies designated shall be kept to a minimum. The practice of designating all personnel attached as mail orderlies shall be carefully reviewed; keeping in mind the fixing of responsibility for accountable mail.

e. Designations. Mail orderlies will be designated on enclosure (3) and DD Form 285, Appointment of Mail Orderly. Designated personnel are required to carry their cards and a valid identification card while performing mail-handling duties and to present the card when receiving mail. DD Form 285 must be strictly accounted for and used only by designated personnel.

f. Terminations. Individuals relieved of mail orderly duties will be reported to the post office by letter with an annotation describing the reason for termination (transfer, separation, etc.) with DD Form 285 card attached.

g. Mail Orderly Training. Mail orderlies must be properly trained prior to assuming mail-handling responsibilities and issuance of their DD Form 285. Training is held on a monthly basis and will emphasize the importance of postal services, individual responsibilities, and the serious consequences of negligence in the performance of duty.

h. Delivery of Minor's Mail. Minors may receive mail in care of their sponsors only. Delivery in care of others will not be permitted. Accountable mail, Registered/Insured/Certified/Express Mail/Return Receipt for Merchandise, addressed to sponsors may be picked up by minors only upon presentation of PS Form 3849, with applicable portions completed by the sponsor, and a valid identification card.

#### 14. Lobby Box Section

a. With regards to reference (a), the Lobby box section provides a means of delivery of mail to family members of personnel attached to ships home ported at Yokosuka. Family members living in the Yokohama area will receive their mail through the Military Post Office in Negishi Housing. Lobby mailboxes will be assigned on a first come basis.

b. Only applications from family members of sponsors, who are attached to ships homeported at Yokosuka or assignment to billets requiring frequent travels, will be processed. Military spouses with official orders to Yokosuka shore based commands are not eligible.

c. Application forms for requesting box assignment are available at the serving post office.

d. Negishi and Ikego post offices provide mail delivery service to DoD personnel and military members residing in Negishi and Ikego Housing and BEQ/BOQ through individual boxes. In the event existing boxes are in use, a waiting list will be established. Applications will be placed in chronological order and assignment will be made as boxes become available. Provisions will be established for temporary general delivery of mail for customers placed on the waiting list.

e. Individuals not issued a lobby box will receive their mail through their respective division, department, agency, organization, bank or exchange by means of the "Mail Orderly System."

f. Personnel with assigned boxes will not allow personnel other than their authorized family members to use their box number for their correspondence. This restriction from use includes visiting friends and family who are not legal/authorized family members of the service member. Violations of this restriction could result in appropriate legal action, a 90-day notice of lobby box closure, and termination of MPS privileges

15. Non-Mailable Matter. USPS regulations define any article, composition, or material that may kill or cause injury, or damage the mail or property is non-mailable. The mailer is responsible that items and substances presented for mailing are not prohibited by postal laws or regulations. Non-mailable matter includes the following:

a. Lottery matter.

b. Solicitations or inducements for mailing harmful matter, radioactive material, switchblade knives, or intoxicating liquor.

c. Copyright violations.

d. Lewd or filthy matter.

e. Libelous matter.

f. Matter relating to national or international defense.

g. Controlled substance.

16. Complaints and Suggestions. Consumer Service Program provides postal customers with a convenient, systematic means of communicating complaints on Consumer Service Card, PS Form 4314-C. Cards are available in the post office lobby for recording complaints, suggestions, information requests, and compliments.

17. Incoming Mail. Incoming mail is received once or twice daily. COMFLEACT Yokosuka and tenant commands mail shall be distributed by means of the "Mail Orderly System." Mail for DoD personnel and military members residing in Negishi Housing, Ikego housing and

BEQ/BOQ, will be sorted into individual lobby boxes. Otherwise, mail will be delivered to the sponsor's command.

18. Outgoing Mail. Navy post offices 96348, 96349, and 96351 dispatches outgoing mail to FMC Yokohama once daily.

19. Emergency Destruction/Evacuation of Postal Effects. Official registered mail shall be given priority in any emergency evacuation actions conducted by postal personnel. The following priorities are established for use in arranging evacuation, affording protection, and if necessary, ensuring the destruction of mail and postal effects.

a. Official registered mail.

b. Directory service cards.

c. Blank postal Money Order forms.

d. Currency and coins.

e. Postage stamps and stamped paper.

f. Paid Money Orders and checks on hand.

g. Money Order imprinters.

h. Other accountable mail.

i. All remaining mail.

j. All purpose and canceling stamps.

k. All other records, equipment, mail sacks and furniture.

20. Customs Procedures and Requirements

a. Responsibility for Compliance. Compliance with customs laws is the responsibility of the individual mailer. Postal personnel shall assist mailers to the extent that the appropriate customs declaration form is attached to items presented for mailing.

b. Mail Subject to Customs Examination and Duty

(1) All mail believed to contain merchandise, including sealed letters, letter packages, returned articles of U.S. origin, and printed matter, mailed outside the Customs Territory of the

United States (CTUS) and addressed for delivery point within CTUS is subject to customs examination by U.S. and Japanese Customs officials at FMC Yokohama per references (a) and (b).

(2) Merchandise mailed to the U.S. for which “entry-free of customs duty” is not specifically provided is subject to customs duty.

c. Customs Declarations

(1) Mailers must use either customs declaration form, PS Form 2976 or PS Form 2976-A, depending on the destination of the article being mailed and provided the form is completed properly and lists and describes the entire contents. The class of mail does not determine the customs form to be used. However, a PS Form 2976-A must be used if the article is going to CONUS. This satisfies the memorandum agreement between the Federal Aviation Administration (FAA) and the Department of Defense (DoD) concerning the security of mail. A PS Form 2976 may be used when a PS Form 2976-A is enclosed within the article should be used on parcels too small to accommodate a PS Form 2976-A.

(2) Customs forms are not required on official mail except as required by Part 144.1, International Mail Manual (IMM).

(3) All mail, originating outside the customs territory of the United States (i.e., outside the 50 states, the District of Columbia, and Puerto Rico) is subject to customs examination, except letter mail known or believed to contain only correspondence or documents. Assessment of customs duty is outside the control of the USPS; therefore, postal clerks can not and will not inform any customers whether any items either gifts or commercial shipments will be subject to customs duty. However, postal clerks do suggest that the customers inform the addressee before they mail so that the latter may determine whether those items are dutiable. Questions, complaints, concerns can be addressed to the nearest U.S. customs office listed in the IMM 711.62.

d. Customs Interdiction Measures. The following procedures are set forth to facilitate the interception of contraband materials introduced into overseas military postal channels and to ensure compliance with Navy Postal and Local Customs Regulations:

(1) Parcels will be accepted for mailing only from personnel authorized military postal privileges.

(2) Parcels must bear the sender’s name and complete return address. The mailer shall be required to present their Armed Forces identification card at the time of mailing.

(3) Japanese customs occupy an area at FMC Yokohama to monitor and inspect incoming U.S. mail by use of an X-Ray machine and/or Narcotic/Explosive working dogs. The mail inspected will be stamped with the official customs office stamp and all contraband items confiscated and the addressee notified.

(4) U.S. military working dogs with handler will provide random search of incoming mail to detect the mailing of narcotics and explosives.

e. U.S. Merchandise. Articles that are grown, produced, or manufactured in the U.S., after having been exported, not advanced in value or improved in condition, may be mailed back to the U.S. free of customs duty. However, a properly completed customs declaration form shall be attached to the address side of the parcel with the words “Returned U.S. Merchandise” written on the customs form.

f. Personal and Household Effects (PCS Movement Orders)

(1) Personal and household effects of individuals returning to the U.S. under government orders duty free will be accepted for mailing provided:

(a) The parcel does not exceed 108 inches length and girth combined and does not weigh over 70 pounds in weight.

(b) A copy of the orders is attached outside and enclosed inside the parcel.

(c) The words “Free Entry Claimed Under Public Law - Movement Orders Enclosed” are placed on the address side of the parcel.

(d) A properly completed customs declaration has been attached to the parcel.

(e) The customer pays the postage and any fees incurred.

(2) Personal and household effects mailed under Postage and Fees Paid must be shipped through Fleet Industrial Supply Center or appropriate Supply Office.

g. Bona Fide Gifts not Exceeding \$100.00 in Value. No duty or internal revenue tax is chargeable for bona fide gifts not exceeding \$100 in value mailed from MPOs located outside the CTUS to an address in the United States. The value of the gift is determined by the retail value in the country of acquisition. Duty free mailings to CTUS are subject to the following situations:

(1) A customs declaration form shall be completed and attached to each article or parcel mailed.

(2) Each parcel must be clearly marked “Bona Fide Gift Not to Exceed \$100.00 in Value”. To meet this qualification, the article formerly must have been owned by a donor who gave it out right, in its entirety, to a donee without compensation or a promise of compensation.

(3) The exemption applies, provided the accumulated value of such articles received by one person on one day does not exceed \$100.00. A parcel having a total value of more than \$100.00, that contains individually wrapped and addressed gifts is entitled to free entry, provided the other conditions are met. The parcel shall be annotated on the address side indicating the number of separate packages contained therein and stating that each gift is valued at \$100.00 or less.

h. Personal Use. No duty or internal revenue tax is chargeable for article destined for “Personal Use” of the mailer. The dollar value of the exemption is \$200.00 or less, and applies to articles mailed into the U.S. from deployed ships and overseas shore stations.

(1) A customs declaration form shall be completed and attached to each article or parcel mailed.

(2) Each article must be marked “Personal Use.”

21. Official Mail Program. The Administrative Officer is designated as the Official Mail Manager (OMM) responsible to the Commander for the official mail functions of the command.

a. OMM shall coordinate/provide the Official Mail Management training per enclosure (1) of reference (f), Chapter 2; paragraph c.2 for all tenant commands served.

b. Official mail destined for delivery outside the COMFLEACT Yokosuka geographical area requires USPS commercial postage. Consolidate mail addressed to one location as a cost-saving measure. Authorize use of Navy Official Mail is contained in reference (f).

c. Stringent control over official mailings shall be the responsibility of each department head.

d. Official mail will not be deposited in mailboxes.

e. Unauthorized Uses

(1) For private use.

(2) Goods for resale or pertains to collection of income due to non-appropriated funds.

(3) To send greeting cards, Christmas cards, job resumes or invitations to social functions (except events that are authorized per reference (j)).

(4) Anything mailed by concessionaires or their employees.



(5) Dependent school year books and other unofficial items such as announcement cards, thank-you cards, memory albums, biographies.

(6) Mailings by or for private associations, such as unit associations, Wives Club, Boy Scouts, etc.

(7) Mailing matter donated by individuals for donations to other individuals, charitable and nonprofit organizations.

(8) Matter that is not exclusively U.S. Government business.

(9) For mail not bearing a return address.

(10) For mail that does not relate exclusively to the business of the U.S. government.

## 22. DoD Official and Personal Intra-theater Mail

a. Intra-theater Delivery Service (IDS) may be used for personal correspondence. IDS is an internal service of MPS vice USPS. IDS is a postage free system and is not regarded as mail. IDS shipments are not eligible for claims reimbursement for loss or damage.

b. Personal mail that does not exceed 108 inches in length and girth combined and does not weigh over 70 pounds is eligible for IDS service. Special services such as registered, certified, numbered insured, and return receipt for merchandise is not authorized for IDS mail.

c. Endorsements required for official and personal intra-theater mails are:

(1) Official inter-theater mail: Words "DoD Official Intra-theater Mail" shall be typewritten, rubber stamped, or mechanically printed in the area where the postage would normally be placed.

(2) Personal inter-theater mail: Sender must write "MPS" on upper right corner in place of a stamp.

d. IDS mail must have a complete military address, be originated at an overseas MPO, and be addressed to another MPO within the same geographical area. For example: From - FPO AP 96347 to FPO or APO 96373 not FPO AP 96347 to FPO AE 09838.

e. Undeliverable items will be returned to sender. An IDS Dead Letter File is established for items without postage that cannot be delivered or returned to sender. FMC Yokohama is designated as the IDS Dead Letter Office for Pacific Navy activities. Items of no value (i.e., catalog, advertisement, etc.) will be disposed of within 48 hours of receipt. Items of a value, including cash, will be turned over to a service welfare charitable organization. No IDS correspondence will be forwarded to enter the USPS (CONUS, international addresses, Guam, Hawaii, and Alaska.)

23. Parcel Security Statement. Memorandum of Agreement between the Federal Aviation Administration (FAA) and Department of Defense (DoD) concerning the security of military mail. By completing and signing the parcel security statement on the new International Mail Custom Form, the member is declaring those items entered into the Military Postal System are free from explosives and are subject to security controls appropriate for civil aviation security. This information will remain on file for 30 days and may be used by FAA/DoD and or other government investigative authorities and law enforcement agencies.

24. Forms. All forms listed below will be available at the local post office, except CFAY 5110/2 (Rev. 4-97), Designation of Mail Orderly/Clerk (enclosure (5)), may be reproduced locally.

a. Form 2976, Customs CN22

b. Form 2976-A, Customs Declaration and Dispatch Note

c. PS Form 2976-E Customs Dispatch note, customs form (Envelope)

d. PS Form 1590, Supplies and Equipment

- e. DD Form 285, Appointment of Mail Orderly
- f. PS Form 4314-C, Consumer Service Card
- g. PS Form 3294, Report of Audit of Postal Accounts

25. Audits and Inspections. Audits and inspections are management tools designed to ensure the proper administration of the post office. Postal audit procedures shall be conducted per reference (c) and Pacific Fleet Postal Finance Officer (PFO) handbook.

a. An audit of all accountable postal effects in custody of a Military Postal Clerk (MPC), COPE will be completed on a monthly basis. PFO will be audited quarterly. Audits will be conducted on PS Form 3294. Audits will be variably spaced unannounced scheduled on succeeding months and completed by two or more members of the Command Moneys Audit Board.

- (1) The postal officer will be present during all audits.
- (2) Exchange of funds or stamp stocks between accounts during the audit is unauthorized.
- (3) Cash may not be exchanged for checks until all funds have been verified.
- (4) During an audit, clerks may not use the account to transact business of any sort. Service windows will be closed until the audit is completed.
- (5) Account holders must show full accountability at the time of audit.

b. Originals of monthly/quarterly postal audits will be retained in MPO files. Copies of quarterly postal audit reports of the MPC, COPE, and PFO for the quarters ending in March, June, September and December shall be forwarded to Postal Finance Officer, San Diego, and a copy to CINCPACFLT (N4142) within ten working days of completion of audits. The commanding officer will review all monthly and quarterly postal audits.

26. Postal Reports

a. Postal Activities Reporting System (PARS)

(1) The PARS report is designed to collect and report on a quarterly basis standard operational data (registered, numbered insured and unnumbered insure) generated at MPS activities.

(2) Reports shall be submitted by message or E-mail to CINCPACFLT (N4142) the month following the end of the quarter.

b. Commerce Data (International Balance of Payment Report)

(1) The Department of Commerce has requested that the Executive Director Military Postal Service Agency (MPSA) resume collecting data for their quarterly Balance of Payment Reports per MPSA message 080653Z Jul 96. This information was once reported to MPSA in the quarterly PARS report.

(2) Data will be reported not later than 30 days after the end of the quarter. The following format will be provided to MPSA via electronic message, E-Mail or memorandum:

- ZIP Code
- Geographic Location
- Country Code
- Stamp Sales
- Meter Sales
- Money Order sales
- Money Orders Cashed

- Registered Mail Accepted
- Numbered Insured Mail Accepted
- Unnumbered Insured Mail Accepted

**Mailing Addresses for COMFLEACT Yokosuka and Ikego Housing Area**

1. The correct mailing address for patrons receiving mail through commands served by Navy post office, FPO AP 96349 is as follows:

OFFICIAL MAIL	PERSONAL MAIL	FAMILY MEMBER MAIL SECTION
FLEET ACTIVITIES YOKOSUKA PSC 473 BOX # FPO AP 96349-1100	RM1 Larry J. Smith PSC 473 (COMMAND BOX #) FPO AP 96349 + FOUR DIGIT CODE	Mrs. John Doe PSC 473 Box # FPO AP 96349-5555

2. Addresses for tenant commands and activities served by FPO AP 96349, and 96351.

<b>NPO 96349 Tenant Command Listing</b>			
BOX #	PHONE #	ORGANIZATION	ZIP CODE
1	5417	COMMANDER FLEET ACTIVITIES	1100
3	6139	NAVAL COMMUNICATION STA	1800
4/16	5668	SURFACE SHIP ASW ANALYSIS CENTER	2900
5	7533	NRAD FACILITY YOKOSUKA/ SPAWAR	2901
6	7380	CFAY ORDINANCE	1300
8	7150	SHIP REPAIR FACILITY	1400
9	5587	CFAY BRIG	1101
10	6773	CFAY CHAPLAINS OFFICE	1102
11	6393	FLEET AND INDUSTRIAL SUPPLY CENTER	1500
12	7611	COMMANDER NAVAL FORCES JAPAN	0051
13/61	7573	PUBLIC WORKS CENTER (PWC)	1103
14	5141	NAVAL LEGAL SERVICES OFFICES	2400
15	5000	CFAY SECURITY	1104
16	6146	COMMANDER AFLOAT TRAINING GROUP	0052
17	5353	MARINE BARRACKS	1900
19	6812	PERSONAL SUPPORT DETACHMENT (PSD)	1700
20	6601	PHYSICAL SECURITY ENGINEERING FILED ACT.	1106
21	5476	YOKOSUKA PRISON	0008
22	5430	HUMAN RESOURCE CENTER	0009
25	7191	EXPLOSIVE ORDINANCE DISPOSAL DETACHMENT	1107
26	5642	NAVY PUBLISHING AND PRINTING SERVICE	1108
29	5162	CFAY TRANSIENT PERSONAL UNIT	2800
30	7366	CFAY PORT OPERATIONS	1109
33	7562	DECA	2300
40	8052	CFAY SUPPLY	1110
44	6711	POST OFFICE PERSONAL	4444
45	4613	UNIV. OF MARYLAND, CENNTRAL TEXAS COLLEGE, CHAP	0010
50	6688	COMMANDER SUBMARINE GROUP SEVEN	0053
60	7250	MORALE, WELFAARE, AND RECREATION (MWR)	1105
61/13	7573	OFFICER IN CHARGE OF CONSTRUCTION	2903

Enclosure (1)

BOX #	PHONE #	ORGANIZATION	ZIP CODE
68	5595	NAVAL OCEANOGRAPHIC COMMAND CENTER	2902
69	6820	ARMY BETERINAY SERVICES	3000
70	5527	NAVY EXCAHNGE	0003
71	5709	U.S. ARMY ENGINEERING DIST.	3001
73	7944	NCTSI DET FIVE	3003
76	7535	NAVAL INVESTIGATION SERVICE	2500
77	4346	USA FEDERAL CREDIT UNION	0011
78	4585	NATIONS BANK	0004
79	4734	NAVY FEDERAL CREDIT UNION	0012
81	5840	NAVAL SURFACE DEPENDANT ASSISTANCE TEAM	2906
82	8860	COMMANDER WESTERN LOGISTIC GOUP PACIFIC	2907
84	7879	COMMANDER FLEET COORDINATING GROUP	2909
85	4450	NAVY MARINE CORP RELIEF SOCIETY	0085
86	5096	COMMANDER SEVENTH FLEET BAND	2911
89	7378	PACIFIC FLEET AUDIO	2914
90	5770	KITTY HAWK DEPENDANT ASSISTANCE TEAM	2915
91	7779	KITTY HAWK INDOCTRINATION DIVISION	2916
94	7392	AMERICAN RED CROSS (NOW BOX 1038)	0014
95	7392	KINNICK HIGH SCHOOL	0095
96	7392	SULLIVAN ELEMENTARY SCHOOL	0005
57/ 97	7530	NSGA	2903
98	6398	ISSOT	0016
99	5058	NAVY CAMPUS	0099
100	8916	AEGIS TRAINING SUPPORT GROUP	0100
101	5818	ILO	0101
102	9777	AEGIS SUPPORT FACILITY	0102
104	5808	YOKOSUKA TELEPHONE OFFICE	0104
105	5362	FTSCPAC DET YOKOSUKA	0105
107	6231	NAVMASSO DET WESTPAC	0107
108	5736	DESRON 15 DET A	0108
109	7280	DISAPAC IPC	0109
110	5187	GSA	0110
114	5312	NAVY BROADCASTING SERVICE	2905
116	6716	FAMILY SERVICE CENTER	0116
120	5574	CFAY LIBRARY	1111
122	7632	TRIAL SERVICE OFFICE PACDET	0122
124	7001	MARINE FAST BN	0124
126	3785	COMMAND WEST PAC SSO	0126
127	3883	JRNOC	0127
128	7579	YOKOSUKA MIDDLE SCHOOL	0128
129	6071	NORRIS & ASSOC. GOV'T DIV	0129
130	7883	COMNAVAIRPAC DET	0130
NMCB	8059	NMCB	
PSC	BOX	ORGANIZATIONS	ZIP CODE
474	200	OIC Office	96351-0002
	300	Ikego Elementary school	96351-0003
	400	Housing Office	96351-0004
	700	Family Service Center	96351-0007

b. The mailing system for U.S. Naval Hospital is separate, and it's under FPO AP 96350. Address information as follows:

PSC	BOX	ORGANIZATIONS	ZIP CODE
475	1	Commanding Officer	96350-1600
	2	Dental	96350-1605
	3	Laboratory	96350-1606
	5	Patients	96350-1610
	6	Supply	96350-1615
	1500-1895	Individual Box Numbers	96350-1620
	A	General Delivery	96350-0007
		Post Office	96350-0006

Enclosure (1)

**Mailing Addresses for FMC Yokohama and Negishi Housing Area**

1. The following mailing addresses are provided for commands, individuals assigned to mobile units, and Personnel Family Member Mail Section boxes serviced by FMC Yokohama and Negishi Housing Post Office.

2. FMC Yokohama Official:

OFFICIAL MAIL
OFFICER-IN-CHARGE PSC 471 FPO AP 96347-9998

3. Personal mail address for tenant commands and activities served:

OFFICIAL MAIL	PERSONAL MAIL
COMMANDING OFFICER PSC 471 (BOX/COMMAND OFFICE CODE) FPO AP 96347 + (LAST FOUR)	RM1 (SW) QUINCY JONES PSC 471 (COMMAND/OFFICE CODE) FPO AP 96347 + (LAST FOUR)

4. Addresses for tenant commands and activities served by FMC Yokohama.

PSC	ORGANIZATION	ZIP CODE
471	Yokohama Transportation Center (YTC)	96347-0009
	SERVRITE International, Ltd.	96347-0010
	Defense Contract Audit Agency (DCAA)	96347-0012
	Navy Fuel Detachment (NFD) Tsurumi	96347-2000
	Military Sealift Command (MSC)	96347-2600
	U.S. Army Transportation Battalion 836 (836 <sup>th</sup> TRANS BN)	96347-2900
	Provost Marshall Activity (PMA)	96347-3000
	USAF Water Port Liaison Office (WPLO)	96347-4000
	500TH Military Intelligence Group (500MI GRP)	96347-4900
	Headquarters Battalion Camp Fuji and Sub Unit One and CSSD 76	96387-1900

Enclosure (2)

4. Negishi Housing Post Office:

ADDRESS FOR LOBBY BOX	PERSONAL MAIL
MRS JANE SEYMOUR PSC 472 PO BOX # FPO AP 96348-2900	YN1 TOM CRUISE PSC 472 BOX # FPO AP 96348 + 4 CODE

5. Addresses for tenant commands and activities served by Negishi housing post office.

PSC	BOX NO	ORGANIZATIONS	ZIP CODE
472	1	OIC, Yokohama	96348-1100
	1	Security Department, Yokohama	96348-1100
	2	Foreign Service Institute (FSI)	96348-1110
	3	Chaplain/Chapel of the Rising Sun	96348-1120
	4	U. S. Army Veterinary Clinic	96348-1130
	6	Morale Welfare Recreation (MWR)	96348-1140
	7	Navy Hospital Annex	96348-1600
	7	Navy Dental Annex	96348-1600
	8	Library	96348-1100
	9	Navy Resale Activity (260-100)	96348-0003
	12	Byrd Elementary School	96348-0005
	13	PWC Yokohama Branch	96348-1100
	14	Naval Criminal Investigative Service	96348-2500
	17	Military Banking Facility	96348-0004
	20	FISC Detachment	96348-1100
	100-659	Lobby Box Section	96348-2900

Enclosure (2)

**Mailing Addresses for Homeported Ships and Units**

SHIPS NAME	HULL NUMBER	FPO AP	HOMEPORT
USS BLUE RIDGE	LCC 19	96628-3300	YOKOSUKA
USS CURTIS WILBUR	DDG 54	96683-1272	YOKOSUKA
USS CHANCELLORSVILLE	CG 62	96662-1182	YOKOSUKA
USS COWPENS	CG 63	96662-1183	YOKOSUKA
USS JOHN S MCCAIN	DDG 56	96672-1173	YOKOSUKA
USS O' BRIEN	DD 975	96674-1213	YOKOSUKA
USS VINCENNES	CG 49	96682-1169	YOKOSUKA
USS GARY	FFG 51	96666-1505	YOKOSUKA
USS CUSHING	DDG 985	96662-1223	YOKOSUKA
USS VANDERGRIFT	FFG 48	96682-1505	YOKOSUKA
USS KITTY HAWK	CV 63	96634-2770	YOKOSUKA
USS ESSEX	LHD 2	96643-1661	SASEBO
USS FORT MCHENRY	LSD 43	96665-1731	SASEBO
USS GERMANTOWN	LSD 42	96666-1730	SASEBO
USS JUNEAU	LPD 10	96669-1713	SASEBO
USS PATRIOT	MCM 7	96675-1927	SASEBO
USS GUARDIAN	MCM 5	96666-1925	SASEBO
USS SAFEGUARD	ARS 50	96678-3221	SASEBO

Enclosure (3)

**SAMPLE OF COMPLETED OPNAV 5110/5 (NOTICE OF CHANGE OF ADDRESS)**  
**(CURRENTLY ONBOARD)**

<b>NOTICE OF CHANGE OF ADDRESS</b> OPNAV 5110/5 (Rev 3-90)		DATE: November 27, 2000	
NAME (Last, first, middle) SMITH, JOHN C.		RANK/RATE E-6 / PC1	SOCIAL SECURITY NUMBER 691-72-5489
PRIVACY ACT STATEMENT: Authority: Title 39 USC and DOD/U.S. Postal Service Agreement, 2 Feb 59. PRINCIPLE PURPOSES: To route or forward (directory) mail. ROUTINE USES: Used by military and civilian personnel in mail functions Data are inspected by commanders, postal officers, and military and civilian inspectors. Disclosure is voluntary; however, failure to provide the requested information could result inability to forward mail.			
NEW ADDRESS (Consult SNDL for address)  USS KITTY HAWK CV-63 AIMD / IM-2 DIV FPO AP 96334-2770		OLD ADDRESS (Attach mailing label for publisher)  USS JUNEAU (LPD 10) FPO AP 96669-1713	
ESTIMATED REPORTING DATE		DEPENDENT'S NAME (If applicable) KATHY SMITH	
SIGNATURE		RONALD SMITH	
FORWARD SECOND CLASS MATTER FOR 60 DAYS			
ITEM	YES	NO	THIS SPACE FOR POSTAL CLERK
MAGAZINES			
NEWSPAPERS			

**(TRANSFERRED)**

<b>NOTICE OF CHANGE OF ADDRESS</b> OPNAV 5110/5 (Rev 3-90)		DATE: November 27, 2000	
NAME (Last, first, middle) SMITH, JOHN C.		RANK/RATE E-6 / PC1	SOCIAL SECURITY NUMBER 691-72-5489
PRIVACY ACT STATEMENT: Authority: Title 39 USC and DOD/U.S. Postal Service Agreement, 2 Feb 59. PRINCIPLE PURPOSES: To route or forward (directory) mail. ROUTINE USES: Used by military and civilian personnel in mail functions Data are inspected by commanders, postal officers, and military and civilian inspectors. Disclosure is voluntary; however, failure to provide the requested information could result inability to forward mail.			
NEW ADDRESS (Consult SNDL for address)  PSC 471 / FLEET MAIL CENTER FPO AP 96347-9888		OLD ADDRESS (Attach mailing label for publisher)  USS KITTY HAWK CV-63 AIMD / IM-2 DIV FPO AP 96334-2770	
ESTIMATED REPORTING DATE DECEMBER 25, 2000		DEPENDENT'S NAME (If applicable) KATHY SMITH	
SIGNATURE		RONALD SMITH	
FORWARD SECOND CLASS MATTER FOR 60 DAYS			
ITEM	YES	NO	THIS SPACE FOR POSTAL CLERK
MAGAZINES	XX		
NEWSPAPERS		XX	



<b>DESIGNATION OF MAIL ORDERLY/CLERK</b>		
<b>MEMORANDUM FOR POSTAL OFFICER</b>		
Subj: <b>DESIGNATION OF MAIL ORDERLY/CLERK</b>		
Ref: (a) DoD Postal Manual 4525.6-M, Volume II, Chapter 3		
1. Nominee below is trustworthy in character and has not been disciplined for any reasons reflecting unfavorably upon his integrity. Designated individual meets qualifications set forth in reference (a).		
Department/Division		
Name (First-Middle Initial-Last)	SSN	Rate
2. Responsibilities and duties have been explained as required by reference (a) as follows:		
<ul style="list-style-type: none"> <li>a. Mail orderlies must be U.S. Citizen to handle registered mail.</li> <li>b. Return revoked mail cards DD-285 to the post office and notify the postal clerk.</li> <li>c. Present your DD Form 285 when picking up mail.</li> <li>d. Safeguard mail at all times. Mail orderlies may be held directly responsible for any loss brought about by their failure to properly handle mail entrusted to their care. While in the custody of mail orderlies, U.S. mail will be considered inviolate and will not be subject to delay, interception, seizure, rifling or confiscation by any person.</li> <li>e. Deliver mail only to addressee or an agent designated by the addressee in writing.</li> <li>f. Under no circumstances, will mail be placed on bunks, tables, desks, in open boxes or similar places, or otherwise left unprotected while awaiting delivery.</li> <li>g. Return all undeliverable mail to the post office for personnel on leave, hospitalized, TAD, UA status, or transferred. Do not place endorsements on undeliverable mail returned. Notify postal clerk status of addressee for proper disposition of mail.</li> <li>h. Direct questions or complaints, suspected postal offenses, and irregularities concerning mail service to the Postal Officer.</li> </ul>		
Mail Orderly/Clerk Signature/Date		
Department Head Signature/Date		
Postal Officer Signature/Date	DD-285 Issued. D-285 Revoked.	

Enclosure (5)

## Family Member Mail Service

1. Family Member Mail Service provides a means of delivery of mail to family members of personnel attached to ships homeported in COMFLEACT Yokosuka. Family members living in the Yokohama area will receive their mail through the Negishi housing post office.

a. Only applications from family members of sponsors who are attached to ships homeported in COMFLEACT Yokosuka will be processed. Military spouses with official orders to COMFLEACT Yokosuka are not eligible.

b. Application forms for requesting box assignment are available at the serving post office. Individual lobby boxes will be assigned on a first-come basis. In the event of all existing boxes are in use, a waiting list will be established; applications will be made as boxes become available. Provisions will be established for temporary general delivery of mail for customers placed on waiting list.

c. Personnel assigned boxes will not allow personnel other than their authorized family members to use their box number for their correspondence. This restriction from use includes visiting friends and family who are not legal-authorized family members of the service member. Violation of this restriction will result in the forfeiture of the lobby box. Continued violations could result in appropriate legal action.

d. Unauthorized box holders will be issued a 90-day notice of Family Member Mail Service Box closure.

2. Prohibitions. The following practices are prohibited:

a. Acting in any way, as an intermediary for personnel not authorized the use of the military postal service under the specifications in Appendix A of reference (a).

b. Using official government envelopes for private personal correspondence.

c. Placing "guard mail" in the U.S. postal system.

Distribution:

COMFLEACTINST 5215.2E

Same as basic instruction

Stocked:

Commander Fleet Activities, Yokosuka

PSC 473 Box 1

FPO AP 96349-1100

Enclosure (6)

## APPENDIX IV

# DEFINITION OF PARS DATA ELEMENTS

A. ALPHA ID—The ALPHA ID consists of the ZIP + 4 Code of the reporting unit.

Example: ALPHA-ID: 09565-1269

B. AS OF DATE—The AS OF DATE is composed of six numeric characters that indicate the reported quarter. The report date must be in YYMMDD format. The month and date will be the last date of the quarter being reported.

Example: AS OF DATE: 000630

C. MONEY ORDERS SOLD—This data element contains two sets of numeric characters. The first set of characters shows the total number of money orders sold. The second set of characters shows the total value (dollar amount only) of the money orders sold.

Example: MONEY ORDERS SOLD: 457 Value 65487

D. MONEY ORDERS CASHED—This data element contains two sets of numeric characters. The first set of characters shows the total number of money orders cashed. The second set of characters shows the total value (dollar amount only) of the money orders cashed.

Example: MONEY ORDERS CASHED: 45 Value 12222

E. TOTAL STAMP VALUE—This data element contains one set of numeric characters indicating the total stamp sales (dollar amount only) for the quarter.

Example: TOTAL STAMP VALUE: 10000

F. NUMBER USPS POSTAGE METERS—This data element contains two sets of numeric characters. The first set of characters shows the total number of postal meters on hand. The second set of characters shows the total meter sales (dollar amount only).

Example: NUMBER USPS POSTAGE METERS: 2 Sales 43669

G. NUMBER REGISTERED PIECES ACCEPTED—This data element contains one set of numeric characters showing the total number of registered pieces accepted for mailing.

Example: NUMBER REGISTERED PIECES ACCEPTED: 45

H. NUMBERED INSURED PIECES ACCEPTED—This data element contains one set of numeric characters showing the total number of numbered insured pieces accepted for mailing.

Example: NUMBERED INSURED PIECES ACCEPTED: 321

I. NUMBER UNNUMBERED INSURED PIECES ACCEPTED—This data element contains one set of numeric characters showing the total number of unnumbered insured pieces accepted for mailing.

Example: UNNUMBERED INSURED PIECES ACCEPTED: 299

**SAMPLE PARS MESSAGE**

This message is UNCLASSIFIEDFROM: USS NEVERSAIL

TO: CINCLANTFLT NORFOLK VA//N412P/N412P1//

BT

UNCLAS//N05110//

MSGID/GENADMIN/USS NEVERSAIL/0013/JUL//

SUBJ/POSTAL ACTIVITY REPORTING SYSTEM (PARS)//

POC/A.B. SEAMAN/PC2/COPE/-/TEL: COM (757) 445-2975//

RMKS/1. THE FOLLOWING INFORMATION IS PROVIDED:

A. ALPHA ID: 09565-1269

B. AS OF DATE: 000630

C. MONEY ORDERS SOLD: 457 VALUE: 65487

D. MONEY ORDERS CASHED: 45 VALUE: 12222

E. TOTAL STAMP VALUE: 10000

F. NUMBER USPS POSTAGE METERS: 2 SALES: 43669

G. NUMBER REGISTERED PIECES ACCEPTED: 45

H. NUMBERED INSURED PIECES ACCEPTED: 321

I. UNNUMBERED INSURED PIECES ACCEPTED: 299//

BT

#8354

NNNN

## APPENDIX V

# REFERENCES USED TO DEVELOP THE TRAMAN

- Administrative Support Manual*, Issue 13, U.S. Postal Service, Washington, DC, Jul 1999.
- Container Methods*, Handbook PO-502, U.S. Postal Service, Washington, DC, Sep 1992.
- Department of Defense Official Mail Manual*, DOD 4525.8-M, Office of the Assistant Secretary of Defense (Production and Logistics), Washington, DC, Jul 1987.
- Department of Defense Postal Manual*, DOD 4525.6-M, two volumes, Office of the Assistant Secretary of Defense (Production and Logistics), Washington, DC, Dec 1989.
- Department of the Navy Information Security Program Regulation*, SECNAVINST 5510.36, Office of the Secretary of the Navy, Washington, DC, Mar 1999.
- Department of the Navy Official Mail Management Instruction*, OPNAVINST 5218.7B, Office of the Chief of Naval Operations, Washington, DC, Oct 1999.
- Department of the Navy Postal Instructions*, OPNAVINST 5112.6C, Office of the Chief of Naval Operations, Washington, DC, Jun 1998.
- Directives and Forms Catalog*, Publication 223, U.S. Postal Service, Washington, DC, Jun 1999.
- Distributing, Dispatching, and Transporting Military Mail by Air*, Handbook T-7, U.S. Postal Service, Washington, DC, Sep 1993.
- Domestic Mail Manual*, Issue 55, U.S. Postal Service, Washington, DC, Jan 2000.
- Express Mail Military Service*, Handbook PO-514, U.S. Postal Service, Washington, DC, Jun 1989.
- Hazardous, Restricted, and Perishable Mail*, Publication 52, U.S. Postal Service, Washington, DC, Jul 1999.
- International Mail Manual*, Issue 23, U.S. Postal Service, Washington, DC, Jul 2000.
- National Five-Digit ZIP Code and Post Office Directory*, Publication 65A, U.S. Postal Service, Washington, DC, Oct 1999.
- Navy Postal Finance Office Handbook*, NAVSUP Publication 725, Director of Navy Postal Policy, COMNAVSUPSYSCOM, Mechanicsburg, PA, 1999.
- Postal Bulletin*, U.S. Postal Service, Washington, DC.
- Postal Operations Manual*, Issue 8, U.S. Postal Service, Washington, DC, Jul 1998.
- Replenishment at Sea Instructions*, NWP 4-01, Office of the Chief of Naval Operations, Washington, DC, May 1997.
- Requisitioning Labels*, Handbook PO-423, U.S. Postal Service, Washington, DC, Apr 1992.
- Supply and Equipment Catalog*, Publication 247, U.S. Postal Service, Washington, DC, Oct 1999.



# INDEX

## A

- Application and voucher for refund of postage and fees, 10-21
  - Appointment of official mail managers (OMMS), 13-2
  - Articles recovered after payment, 10-15
  - Auditing fixed and flexible credit accounts, 14-5
    - audit results, 14-5
    - auditing stamp vending machines (SVM), 14-9
    - disposition of DD Form 2259 or PS Form 3294, 14-14
    - preparing DD Form 2259 for fixed credits, 14-6
    - preparing PS Form 3294 for flexible credit accounts, 14-10
    - recording audit results, 14-14
    - tolerance limits, 14-5
  - Audits, types of, 14-1
- ## C
- Care and protection of stock and funds, 8-3
    - affixing stamps, 8-5
    - arrangement of stock, 8-4
    - selling stamps, 8-4
    - separating and delivering stamps, 8-4
  - Checklist for special services, 5-13
  - Checklist for special services, international, 6-22
  - Claim for indemnity—international registered, insured, and express mail, 10-15
  - Claims and inquiries, 10-1, 13-14
    - forms needed, 10-2
    - inquiries or complaints, 10-1
    - responding to mistreatment of mail, 10-2
  - Closing the registry section, 7-22
    - daily accountability, 7-23
    - registry cage, 7-25
  - Closures, 3-4
    - Adhesives, 3-4
    - banding, 3-4
    - markings, 3-5
    - stapling, 3-5
    - tape, 3-4
  - Consumer service card, 10-2
  - Cushioning, 3-4
  - Customs forms and procedures for international mail, 6-12
    - customs charges, 6-13
    - customs declarations, 6-12

- Customs forms and procedures for international mail—Continued
  - PS Form 2976, 6-12
  - PS Form 2976-A, 6-12
  - PS Form 2976-E Envelope, 6-12
- Custom procedures for domestic mail, 4-17
  - American goods returned, 4-21
  - attaching customs declarations, 4-21
  - bona fide gifts, 4-21
  - checklist for acceptance of domestic mail, 4-22
  - customs declarations, 4-17
  - items bearing a trademark or tradename, 4-22
  - personal property and household effects, 4-22
  - prepayment of customs duty abroad, 6-14
  - refusal or protest of customs charges by addressee, 6-14

## D

- Definitions, 2-1, 9-1
  - mail clerk responsibilities, 9-1
  - mail orderly responsibilities, 9-1
- Designations and terminations, 2-1
- Disposition of USPS equipment and supplies, 12-23
- Documentation requirements for dispatching, 9-36
  - PS Form 2942-A (AV-7), 9-36
  - DD Form 1372 (Mail Manifest), 9-37
  - DD Form 1384 (TCMD), 9-39
  - OPNAV FORM 5110/9, 9-41
- Domestic claim or registered mail inquiry (PS Form 1000) (Indemnity Claim), 10-6
  - duplicate claims, 10-11
  - how to file a claim, 10-6
  - preparation of PS Form 1000, 10-19
  - process PS Form 1000, 10-11
  - time limits for filing, 10-6
  - where to file, 10-6
  - who may file, 10-6
- Domestic mail, 4-1
  - introduction to, 4-1

## E

- Entitlement to use military postal facilities, 1-17
  - authorized personnel, 1-18
  - emergency or special authorizations, 1-18
  - identification, 1-19
  - retired military personnel, 1-19

Entitlement to use military postal facilities—

Continued

Service for related organizations, 1-18  
unauthorized personnel, 1-18

Exchanging damaged stamp stock, 8-14

Express mail, 4-3

acceptance, 4-3

cut-off time, 4-4

determining postage, 4-3

distribution of label 11-B, 4-4

express mail military service (EMMS) accounting  
procedures, 4-4

packaging, 4-3

USPS Label 11-B, 4-3

**F**

Facilities for mail deposit, 9-15

collection boxes, 9-15

collection schedules, 9-16

locking devices for collection boxes, 9-15

Finance, postal, 8-1

First class mail, 4-5

balloon surcharge, 4-10

canceling the stamps, 4-10

determining the postal zone, 4-7

endorsements, 4-10

examples of first-class matter, 4-5

first-class zone rated (priority) mail, 4-6

first-class zone rates, 4-8

official zone charts, 4-7

periodicals mailed by the general public, 4-11

postage rates, 4-7

postal zones, 4-6

two or more packages, 4-10

weight and size limits, 4-6

what may be mailed by the general public, 4-11

Fixed credit, 8-5

authorization letter for retention of stamp stock in  
excess of \$1000 by a window clerk, 8-8

change in custody, 8-7

custody of fixed credit, 8-6

establishing original stamp stock, 8-5

increasing or decreasing, 8-11

receipt of original stamp stock, 8-5

Forms of addresses, 3-9

acceptable addresses, 3-9

address placement, 3-9

FPO addresses, 3-11

mail sent via Department of State, 3-11

military addresses, 3-10

nonacceptable addresses, 3-9

sender's instructions for holding mail, 3-9

**H**

Hazardous matter, 3-13

casualty mail, 11-25

controlled substances, 3-14

dead mail, 11-25

flammable materials, 3-13

Hold mail, 11-19

incorrectly addressed or illegible addressed mail,  
11-23

mail for decommissioned ships and disestablished  
stations, 11-26

matches, 3-14

members absent without leave (AWOL),  
11-20

members due to arrive, 11-20

refused mail, 11-20

toxic substances, 3-14

**I**

Increasing or decreasing fixed credit, 8-11

decrease, 8-13

increase, 8-11

Inquiry about a registered article or an insured parcel  
or an ordinary article, 10-14

Integrated retail terminal, 8-52

International Mail Checklist, 6-21

International Mail Manual, 6-1

categories of international mail, 6-2

countries not listed, 6-2

individual country listings, 6-2

locating information, 6-1

makeup of the international mail manual, 6-1

**L**

Loads, types of, 3-1

acceptable containers, 3-1

average load, 3-1

boxes, 3-2

cans and drums, 3-3

difficult load, 3-1

easy load, 3-1

envelopes, 3-3

fiberboard tubes and long packages, 3-3

outside wraps for boxes, 3-3

package surfaces, 3-2

**M**

Mail bombs, 3-14

Mail Directory Service, 11-1



- Mail handling and transportation, 9-1
- Mail logs and equipment, 9-13
  - incoming and outgoing mail logs, 9-13
  - mail transport equipment (MTE), 9-13
- Mail Loss/Rifling Report (PS Form 1510), 10-3
  - preparation of PS Form 1510, 10-4
  - process PS Form 1510, 10-5
- Mail packaging and acceptance, 3-1
- Mail preparation, 3-1
- Military inspections, 14-14
  - postal activity reporting system (PARS) information requirements, 14-20
  - postal assistance advisor, 14-21
  - reporting procedures, 14-21
  - vending equipment sales and service (VESS) reports, 14-19
- Military postal service, 1-1
  - mission and function, 1-1
  - nature of the military postal system, 1-1
  - types of mail and postal service, 1-3
- USPS/DOD postal agreement, 1-2
- Money orders, 8-25
- Money order equipment, 8-31
  - money order imprinter, 8-31
  - security of money order imprinter, 8-32
- Money order forms, 8-25
  - accounting for money order forms, 8-29
  - care in handling money order forms, 8-31
  - emergency requisitions, 8-27
  - money order invoice, 8-29
  - money order set, 8-25
  - money orders held by postal clerk, 8-29
  - receipt of money order forms, 8-27
  - requisitioning blank money order forms, 8-26
  - safeguarding money order forms, 8-31
- Money order inquiry, 10-21
- Money orders, issue of, 8-33
  - cashing money orders, 8-36
  - conditions for issuing “no fee” money orders, 8-34
  - identification, 8-36
  - issuing procedures, 8-33
  - money order cashing procedures, 8-36
  - money order fees, 8-33
  - signature requirements, 8-36
  - spoiled money orders, 8-34
  - spoiled or incorrectly prepared money orders, 8-34
  - transfer of money orders, 8-36
- Money order reports, 8-39
  - disposition of money order items, 8-50
  - money order tapes, 8-39
  - other than ordinary money order reports, 8-46
- PS Form 6019, 8-42

## N

- Navy Official Mail Cost Control Program (NOMCCP), 13-1
  - appointment of official mail managers (OMMS), 13-2
  - balloting materials, 13-5
  - direct accountability, 13-2
- DOD official intratheater mail, 13-5
  - express mail, 13-5
  - military ordinary mail, 13-5
  - special mail services, 13-3
  - treatment of official mail, 13-3
  - USPS penalty mail, 13-5
- Nonmailable matter, 3-11

## O

- Official mail, 13-1
- Ordering postal publications, 12-23
- Outgoing mail, 9-15

## P

- Parcel post, 6-10
  - packaging requirements, 6-11
  - parcel post restrictions, 6-10
  - parcel post service, 6-10
  - postage rates, 6-11
  - transportation of international mail, 6-12
  - weight and size limits, 6-11
- Parcel search request, 10-13
- Periodicals, 4-11
  - periodicals mailed by the general public, 4-11
  - what may be mailed at the periodicals rates, 4-11
- Postage meters, 8-14
  - absence of operator, 8-21
  - defective postage meter machines, 8-25
  - issuing the meter, 8-18
  - meter registers, 8-18
  - operating the postage meter, 8-20
  - returning meters at the close of daily business, 8-23
  - safeguarding postage meters, 8-18
  - what is a postage meter, 8-14
- Postage, obtaining and accounting for, 13-6
  - checklist, 13-11
  - computer-generated postage, 13-8
  - inspections, 13-11
  - postage metering systems, 13-11
  - postage meters, 13-11
  - postage stamps, 13-6

- Postage payment, 9-17
  - business reply mail, 9-18
  - free mail, 9-19
  - international mail sent free, 9-19
  - intratheater delivery service, 9-19
  - mail with insufficient postage, 9-18
  - mail without postage, 9-18
  - official mail, 9-19
  - unauthorized mailers, 9-18
- Postage stamps and stamped paper, 8-1
  - forms of issue, 8-1
  - kinds of stamps, 8-2
  - validity of stamps, 8-1
- Postal directory functions, 11-1
  - filing instructions, 11-1
  - holding period for ordinary mail, 11-7
- Navy Directory Service Program, 11-4
  - processing directory mail, 11-5
  - purging directory cards for destruction, 11-3
  - the directory service stamp, 11-6
  - undeliverable-as-addressed mail, 11-7
- Postal equipment and supplies, 12-1
- Postal facilities, 1-5
  - aerial mail terminals, 1-7
  - airport mail facility/center, 1-6
  - bulk mail centers, 1-6
  - fleet mail centers, 1-7
  - joint military postal activities, 1-5
  - military post offices, 1-6
- Postal messages, 14-24
  - mail on hand/dispatch report, 14-5
  - mail routing instruction (MRI), 14-25
  - postal net alert, 14-24
  - special reports of postal violations, losses, and offenses, 14-27
- Postal personnel, 1-7
  - custodian of postal effects, 1-10
  - financial postal clerk, 1-10
  - mail clerk, 1-10
  - mail orderly, 1-10
  - military postal clerks, 1-9
  - money order verification officer, 1-10
  - monies audit board, 1-11
  - postal assistance advisors, 1-11
  - postal clerk rating and responsibilities, 1-7
  - postal officer, 1-10
  - prospective relief, 1-9
  - qualifications, 1-9
  - reserve custodian, 1-10
- Postal stationery, 8-3
  - aerogrammes, 8-3
  - stamped cards, 8-3
  - stamped envelopes, 8-3
- Postal union mail, 6-2
  - addressing, 6-5
  - aerogrammes, 6-7
  - envelopes, 6-4
  - letters and letter packages, 6-5
  - matter for the blind, 6-8
  - packaging requirements, 6-4
  - payment of postage, 6-5
  - postal cards and postcards, 6-6
  - printed matter, 6-7
  - prohibitions and restrictions, 6-2
  - small packets, 6-9
- Postmarking and canceling mail, 9-20
  - airport-coded tags (flight tags) and self-adhesive labels, 9-27
  - applying the postmark, 9-21
  - bundling mail, 9-22
  - care in pouching, 9-26
  - dispatching mail at fleet mail centers, 9-33
  - dispatching outside pieces/mail, 9-26
  - flat mail trays, 9-24
  - film mailers, 9-25
  - hazardous material, 9-25
  - managed mail (MM) letter trays, 9-23
  - parcels, 9-25
  - philatelic cancellations, 9-21
  - postmarking equipment, 9-21
  - labeling pouches, 9-26
  - mail for military and foreign addresses, 9-25
  - mail sorting, 9-22
- Post office audits, reports, and inspections, 14-1
- Post office files and records, 14-27
  - setting up postal files, 14-27
  - safeguarding postal records, 14-30
  - retention period for records and forms, 14-30
- Pouching, 9-24
  - preparation of mail for dispatch, 9-20
  - collection of mail, 9-20
  - facing the mail, 9-20
- Preparation and processing, 13-15
  - collection, 13-16
  - consolidation, 13-16
  - mail classification, 13-17
  - postmarking, 13-17
  - pouching, sacking, or traying outgoing official mail, 13-18
  - preparation, 13-15
  - security, 13-18
  - sorting, 13-17

- Processing registered mail for dispatch, 7-8
  - dispatching mail directly to military post offices, 7-12
  - dispatching mail directly to U.S. commercial and military air carriers, 7-10
  - mail pouches and sacks, 7-8
  - numbered seal pouches, 7-8
  - registered outside pieces, 7-8
- Processing incoming registered mail, 7-13
  - bill discrepancies, 7-16
  - delivery damaged registered articles, 7-18
  - delivery of registered mail to addressee, 7-18
  - irregularities in receipt, 7-14
  - processing upon receipt, 7-16
  - receipt of registered mail, 7-14
  - receipting for damaged registered mail, 7-15
  - reporting irregularities, 7-16
  - undeliverable registered mail, 7-18
- Processing undeliverable-as-addressed mail, 11-7
  - addressee not authorized military post office privileges, 11-17
  - directory mail returned from unit mailrooms, 11-19
  - express mail/first class mail, 11-8
  - mail for personnel confined, 11-17
  - periodicals, 11-10
  - perishable items, 11-19
  - standard mail (A) (bulk rate), 11-14
  - standard mail (B), 11-17
  - voting and balloting material, 11-17

## R

- Receipting for mail, 9-41
  - air carrier irregularities and reporting procedures, 9-46
  - air mobility command carriers, 9-47
- PS Form 2759 for U.S. commercial carriers, 9-46
- Receiving USPS postal supplies, 12-18
- Registered mail, 5-1, 7-1
- Registered mail system, 7-1
  - canceling stamps and applying endorsement, 7-5
  - computing postage and fees, 7-3
  - negotiable and nonnegotiable instruments, 7-1
  - postal insurance, 7-1
  - postmarking, 7-5
  - preparation by sender, 7-1
  - refunds and recalls, 7-5
  - registered mail receipt, 7-4
  - registration numbers, 7-3
  - what may be registered, 7-1
  - window envelopes, 7-2
- Receipt of stock, 8-9

- Registered mail processing, 7-5
  - confidential, 7-6
  - secret, 7-6
- Report of rifled parcel, 10-13
- Reports, inspections, and assessments, 14-3
  - annual and semiannual postal assessments, 14-3
  - daily reports, 14-3
  - quarterly postal activity reporting system (PARS) report, 14-3
  - USPS four-week accounting period report, 14-3
  - weekly inspections, 14-3
- Replenishment, 8-8
  - activity fixed credit, 8-8
  - individual fixed credit, 8-8
  - replenishment guidelines, 8-8
- Registered mail, purpose of, 7-6
- Restricted matter, 3-15
  - agriculture import requirements, 3-17
  - battery-powered devices, 3-15
  - firearms, 3-16
  - intoxicating liquors, 3-15
  - knives and sharp objects, 3-15
  - liquids and powders, 3-15
  - mail addressed to APOs and FPOs, 3-17
  - marking of parcels, 3-16
  - odd-shaped items in envelopes, 3-15
- Rules and procedures, 3-12
  - general advice to mailers, 3-12
  - injurious articles, 3-12
  - mailer's responsibility, 3-12
  - other nonmailable matter, 3-13
  - procedures for accepting clerks, 3-12

## S

- Sender's application for recall of mail, 10-15
- Selection and designation of military post office personnel, 2-1
  - designation of custodian of postal effects, 2-4
  - designation of mail orderlies, 2-4
  - designation of military postal clerk, 2-1
  - designation of monies audit board members, 2-10
  - designation of postal officer, 2-9
  - designation of reserve custodian for bulk stamp stock, 2-9
  - blank money order forms, and money order audit and verification officer, 2-9
  - designation of temporary COPE, 2-8
- Service Commitments, 1-3
  - customer information, 1-5
  - customer service, 1-4

- Shipboard and overseas MPOS, 9-9
  - articles found loose in the mails, 9-9
  - delivery of accountable mail, 9-10
  - delivery of incoming mail, 9-10
  - disposition of damaged mail, 9-10
  - general delivery service, 9-10
  - irregularities, 9-11
  - military origin destination information system (MODIS), 9-9
  - sorting incoming parcels, 9-10
  - sorting mail, 9-10
  - uncanceled stamps found loose in mail, 9-11
- Special services, 5-1
  - registered mail, 5-1
- Special services, international mail, 6-14
  - certificate of mailing, 6-15
  - insurance, 6-17
  - registry service, 6-17
  - return receipt, 6-18
  - restricted delivery, 6-20
  - recall/change of address, 6-20
  - special delivery, 6-20
  - special handling, 6-20
  - recorded delivery, 6-20
  - supplementary services (reply coupons), 6-21
- Special services, other, 5-1
  - certificates of mailing, 5-6
  - certified mail, 5-1
  - insured mail, 5-2
  - numbered insured mail, 5-5
  - restricted delivery service, 5-12
  - returned receipt for merchandise, 5-11
  - returned receipt, 5-7
  - special handling, 5-5
  - unnumbered insured mail, 5-4
- Sources of information, 1-11
  - Administrative Support Manual, 1-13
  - changes to publications, 1-17
  - Container Methods (HDBK PO-502), 1-14
  - Department of Defense Postal Manual, 1-12
  - Department of the Navy Postal Instruction, 1-12
  - Directives and Forms Catalog (PUB 223), 1-14
  - Distributing, Dispatching and Transporting Military Mail by Air (HDBK T-7), 1-14
  - Domestic Mail Manual, 1-13
  - Express Mail Military Service (HDBK PO-514), 1-15
  - Financial Management Regulation, 1-15
  - International Mail Manual, 1-13
  - National five-digit zip code and post office directory, 1-14
  - Navy Notices and Instructions, 1-15
  - Navy Postal Finance Office Handbook, 1-12
  - Postal Bulletins, 1-15
  - Postal Operations Manual, 1-14
  - Publication 52—Acceptance of Hazardous, 1-14
  - Restricted, or Perishable Matter, 1-14
  - Requisitioning Labels (HDBK PO-423), 1-14
  - Standard Navy Distribution List, 1-15
  - Supply and Equipment Catalog (PUB-247), 1-14
  - Supply storage, 12-18
    - monitoring supplies, 12-18
    - inventory control, 12-19
  - Size limits, 4-2
  - Special items, 12-19
    - facing slips and slide labels, 12-20
    - postmarking equipment (rubber and steel stamps), 12-20
    - preprinted tags and labels, 12-23
    - special order rubber stamps, 12-19
    - year type, 12-20
  - Stamp requisitions, 8-9
  - Parcel Airlift (PAL), 4-15
  - Space Available Mail (SAM), 4-14
    - special standard mail, 4-15
    - standard mail (B), 4-12
  - Standard mail, 4-12
    - library mail, 4-16
  - Standard operating procedures and postal operating plan, 14-31
    - postal operating plan, 14-31
    - standard operating procedures, 14-31
  - Steps for processing postal union and parcel post articles, 6-22
- T**
  - Transportation of military mail, 9-34
    - funding for military mail transportation, 9-34
    - types of transportation methods, 9-34
  - Treatment of incoming international mail, 9-13
    - insured parcels, 9-13
    - return receipts, 9-13
    - special delivery, 9-13
  - Termination of military post office personnel designations, 2-12
  - Termination of COPE designation, 2-12
  - Termination of mail orderly's designation, 2-12
  - Termination of MPC Designation, 2-12
  - Training, 1-11
- U**
  - Unauthorized transactions, 8-5
  - Unit mailroom operations and mail orderly service, 9-2
    - delivery of official accountable mail, 9-4

Unit mailroom operations and mail orderly service—

Continued

- delivery of ordinary mail, 9-3
- delivery of personal accountable mail, 9-3
- mailroom structural requirements, 9-2
- restricted delivery, 9-8
- security of mail, 9-2
- storage of accountable mail awaiting delivery, 9-8
- transporting mail, 9-3

USPS capital and sensitive equipment, 12-3

- maintenance of equipment, 12-5
- requisitioning capital and sensitive equipment, 12-5

USPS noncapital and nonsensitive equipment and

- expendable supplies, 12-8
- determining what to requisition, 12-10
- emergency requisition, 12-15
- issuing supplies, 12-9
- supply requisition, 12-11

USPS expendable items, 12-8

## W

Window equipment, 3-17

- calculators, 3-18
- computers, 3-21
- scales, 3-18
- typewriters, 3-21

Written, printed, or graphic matter, 3-13

## Z

Zip Code System, 3-7

- address changes, 3-8

APO/FPO addresses (overseas activities), 3-8

- ships' zip codes, 3-7

Zip Code description, 3-7



---

---

# *Assignment Questions*

---

---

**Information:** The text pages that you are to study are provided at the beginning of the assignment questions.





# ASSIGNMENT 1

Textbook Assignment: "The Military Postal Service," chapter 1, pages 1-1 through 1-19.

---

- 1-1. The Military Postal Service has which of the following missions?
1. To provide service to the DOD agencies in support of DOD missions
  2. To operate military post offices in areas where the USPS does not operate
  3. Both 1 and 2 above
  4. To relieve the USPS of accountability when military mail is handled for overseas transport
- 1-2. The ultimate goal of the Military Postal Service is to provide a level of service equal to that provided by the USPS to the civilian population of the United States.
1. True
  2. False
- 1-3. The Military Postal Service is an extension of which of the following agencies?
1. The U.S. Postal Service
  2. The Military Postal Service Agency
  3. The Department of the Navy
  4. The Department of the Army
- 1-4. The single manager for military postal matters is what official?
1. The Secretary of the Navy
  2. The Secretary of the Air Force
  3. The Secretary of the Army
  4. The Secretary of Defense
- 1-5. The Department of Defense's single point of contact with the U.S. Postal Service is what official?
1. The Executive Director, Military Postal Service Agency
  2. The Secretary of the Army
  3. The Secretary of the Navy
  4. The Secretary of Defense
- 1-6. The Military Postal Service includes which of the following components?
1. Army, Air Force, and Navy only
  2. Navy, Marine Corps, and Coast Guard only
  3. Air Force, Navy, Marine Corps, and Coast Guard only
  4. Army, Air Force, Navy, Marine Corps, and Coast Guard
- 1-7. The Military Postal Service operates according to which of the following policies?
1. The postal laws of the United States
  2. U.S. Postal Service regulations and instructions
  3. Directives issued by the Department of Defense, MPSA, and the military departments
  4. All of the above
- 1-8. The MPSA is composed of a joint staff of Army, Navy, Air Force, and Marine Corps postal personnel, and DOD civilian employees, and is headquartered in Alexandria, VA.
1. True
  2. False

- 1-9. What publication(s) should you consult for more information concerning the USPS/DOD postal agreement?
1. DOD Postal Manual, volume I
  2. OPNAVINST 5112.6
  3. USPS Publication 247
  4. USPS Publication 38
- 1-10. Where in this TRAMAN should you look for the meaning of an unfamiliar postal term?
1. Index
  2. Glossary
  3. Text
  4. Appendix
- 1-11. What publication contains the USPS service commitments?
1. Postal Operations Manual
  2. National Five-Digit ZIP Code and Post Office Directory
  3. Administrative Support Manual
  4. Domestic Mail Manual
- 1-12. Courteous and efficient service are of prime importance in which of the following military postal clerk's responsibilities?
1. Maintaining records and preparing reports
  2. Providing security of postal effects
  3. Conducting window clerk functions with the public
  4. Performing postal supply clerk duties
- 1-13. The postal facilities at the San Francisco and New York gateways are designated as which of the following activities?
1. Joint Military Postal Activity-Atlantic
  2. Joint Military Postal Activity-Pacific
  3. Both 1 and 2 above
  4. Joint Military Postal Coordinators
- 1-14. Both Joint Military Postal Activities act as the single point of contact for the MPSA with what organization?
1. The Department of Defense
  2. The U.S. Postal Service
  3. The Department of the Navy
  4. The Department of the Army
- 1-15. The Joint Military Postal Activity-Atlantic has subordinate elements in what location(s)?
1. Miami, FL, only
  2. Jacksonville, FL, only
  3. Miami and Jacksonville, FL
  4. Charleston, SC
- 1-16. The Joint Military Postal Activity-Pacific has subordinate elements in what location(s)?
1. San Diego, CA
  2. Seattle, WA
  3. Hawaii
  4. Seattle WA, and Hawaii
- 1-17. Which of the following facilities provides the AMF/AMC with instructions for dispatching and transporting APO and FPO mail?
1. BMCs
  2. MPOs
  3. JMPA's
  4. FMCs
- 1-18. How many Bulk Mail Centers are located in the United States?
1. 3
  2. 6
  3. 12
  4. 21

- 1-19. Military Post Offices located in the United States may be a branch of a local civil post office.
1. True
  2. False
- 1-20. A military activity established primarily to serve as a place to receive, distribute, consolidate, transfer, and dispatch military mail for transportation to, from, and within overseas areas, commands, and ships, is designated as what type of facility?
1. Fleet mail center
  2. Joint military postal activity
  3. Bulk mail center
  4. Airport mail facility
- 1-21. An overseas military mail facility responsible for the receipt, distribution, transfer, and dispatch of military mail by air between overseas areas or to or from the United States is designated as what type of activity?
1. Airport mail Facility
  2. Bulk mail facility
  3. Airport mail center
  4. Aerial Mail Terminal
- 1-22. How you handle your incoming and outgoing mail will, in a large measure, decide the reputation of your post office.
1. True
  2. False
- 1-23. All the following values are important to the military postal clerk. What value is a key factor in developing your technical leadership?
1. Integrity
  2. Honesty
  3. Dependability
  4. Neatness
- 1-24. Integrity and financial responsibility only pertain to a military postal clerk's professionalism and not to his or her personal life.
1. True
  2. False
- 1-25. Navy personnel to be designated as military postal clerks must meet which of the following qualifications?
1. Be a U.S. citizen
  2. Possess high moral standards and excellent military bearing
  3. Be financially responsible
  4. All of the above
- 1-26. What publication lists the procedures for designating military postal clerks?
1. Department of Defense Postal Manual, Volume I
  2. Administrative Support Manual
  3. Postal Operations Manual
  4. All the above
- 1-27. A military postal clerk is a person of the U.S. Armed Forces who has been officially designated and authorized by public law to perform postal finance functions and other postal duties.
1. True
  2. False
- 1-28. In the absence of the primary military postal clerk, which of the following individuals is responsible for carrying out postal functions?
1. The alternate military postal clerk
  2. The postal officer
  3. The custodian of postal effects
  4. The money order auditing officer

- |    |                                  |
|----|----------------------------------|
| A. | Postal officer                   |
| B. | Financial postal clerk           |
| C. | Mail Clerk                       |
| D. | Postal Assistance Advisors       |
| E. | Monies Audit Board               |
| F. | Reserve custodian                |
| G. | Money order verification officer |
| H. | Custodian of postal effects      |
| I. | Mail Orderly                     |

IN ANSWERING QUESTIONS 1-29 THROUGH 1-37, SELECT THE APPROPRIATE DESIGNATION FROM THE ABOVE BOX THAT CORRESPONDS WITH THE JOB DESCRIPTION GIVEN IN THE QUESTION. EACH RESPONSE IS USED ONCE.

1-29. An individual assigned to do mail duties at unit mailrooms.

1. B
2. C
3. H
4. I

1-30. An individual from a division aboard ship, designated to pick up mail from the post office.

1. C
2. F
3. H
4. I

1-31. A DOD civilian employee overseas who performs postal duties.

1. A
2. B
3. E
4. H

1-32. Accountable for the stamp stock and other postal effects issued by the USPS.

1. A
2. D
3. F
4. H

1-33. Designated by the commanding officer to hold a portion of the assigned stamp stock.

1. A
2. D
3. F
4. G

1-34. Performs the daily audit of money order business report.

1. A
2. D
3. E
4. G

1-35. Designated by the commanding officer with responsibility for the overall supervision of the command postal operation.

1. A
2. C
3. F
4. H

1-36. Performs monthly audits of command post office.

1. B
2. D
3. E
4. G

- 1-37. A senior Navy postal clerk or DOD civilian employee assigned to provide guidance concerning post office operations.
1. A
  2. D
  3. E
  4. F
- 1-38. In addition to meeting the qualifications for a military postal clerk, Navy personnel scheduled to attend the Postal Clerk A school must have at least how much remaining active duty service after completion of the course?
1. 1 year
  2. 2 years
  3. 3 years
  4. 4 years
- 1-39. Which of the following publications is issued by the Military Postal Service Agency?
1. The Department of Defense Postal Manual
  2. The Navy Postal Finance Office Handbook
  3. The Department of the Navy Postal Instruction
  4. The Postal Operations Manual
- 1-40. The Navy Postal Finance Office Handbook is issued by NAVSUP to supplement which of the following instructions.
1. The Department of Defense Postal Manual
  2. The Department of the Navy Postal Instruction
  3. Both 1 and 2 above
  4. The Postal Operations Manual
- 1-41. For which of the following purposes does the Department of the Navy publish a separate postal instruction?
1. To advise USPS personnel on the appropriate routing of Navy mail
  2. To address Navy unique situations and give additional guidance in the administration of Navy postal operations
  3. To assist MPSA in understanding Navy unique mail handling situations
  4. To establish Postal Clerk manning requirements for shore activities where civil postal facilities are available
- 1-42. Which of the following is NOT a module in the Domestic Mail Manual?
1. Addressing
  2. Forwarding and Related Services
  3. Retail Management
  4. Postage and Payment Methods
- 1-43. Detailed information concerning international postal rates is contained in what publication?
1. The Domestic Mail Manual
  2. The Postal Operations Manual
  3. The Department of Defense Postal Manual
  4. The International Mail Manual

- |    |             |
|----|-------------|
| A. | HDBK PO-502 |
| B. | PUB 52      |
| C. | POM         |
| D. | PUB 65-A    |
| E. | HDBK T-7    |
| F. | ASM         |
| G. | HDBK PO-514 |

IN ANSWERING QUESTIONS 1-44 THROUGH 1-50, SELECT THE APPROPRIATE PUBLICATION FROM THE ABOVE BOX THAT CORRESPONDS WITH THE DESCRIPTION GIVEN IN THE QUESTION. EACH RESPONSE IS USED ONCE.

1-44. Contains policies and procedures for USPS administrative and support functions.

1. B
2. C
3. F
4. G

1-45. Contains policies and procedures for the operational functions of the USPS post offices.

1. A
2. C
3. E
4. F

1-46. Furnishes correct and current ZIP Codes and mailing information.

1. B
2. C
3. D
4. F

1-47. Used to determine the mailability of hazardous, restricted, and perishable materials.

1. A
2. B
3. E
4. G

1-48. Used by USPS, air carriers, and DOD personnel when handling, processing, dispatching, and transporting military mail by air.

1. A
2. C
3. E
4. G

1-49. Contains procedures for properly handling empty equipment.

1. A
2. C
3. F
4. G

1-50. Used by overseas military postal activities for processing Express Mail.

1. A
2. B
3. E
4. G

1-51. Which of the following would NOT be used when ordering postal supplies?

1. PUB 65-A
2. PUB 223
3. PUB 247
4. HDBK PO-423

- 1-52. The Postal Bulletin provides which of the following information?
1. Changes to USPS manuals
  2. Stolen money order lists
  3. Information of general interest to postal personnel
  4. Each of the above
- 1-53. At what time should Postal Bulletins be purged from MPO files?
1. Each month
  2. Each quarter
  3. Either 1 or 2 above, depending upon the space the bulletins take up
  4. After the Postal Bulletins are at least 1 year old
- 1-54. Which of the following publications provides an alphabetical list of ships by name and the correct mailing address?
1. The Department of Defense Postal Manual
  2. The Standard Navy Distribution List
  3. The Department of the Navy Postal Instruction
  4. The USPS Postal Bulletin
- 1-55. What types of Navy directives are issued through the Navy Directives Issuance System?
1. Instructions and bulletins
  2. Notices and instructions
  3. Instructions and manuals
  4. Notices and bulletins
- 1-56. Personnel who are entitled to full use of a military postal facility are designated in the policy established by what organization?
1. Department of Defense
  2. U.S. Postal Service
  3. Civil Service Commission
  4. Military Postal Service Agency
- 1-57. When working at an overseas post office you should always be alert for unauthorized users of postal privileges.
1. True
  2. False
- 1-58. Which of the following organizations or personnel would normally be authorized MPO privileges at any overseas activity?
1. DOD non-appropriated fund activity
  2. Any active duty military personnel
  3. Both 1 and 2 above
  4. A foreign worker of the host country
- 1-59. Which of the following organizations would NOT normally be authorized postal privileges at an overseas MPO?
1. DOD-operated schools
  2. The American Red Cross
  3. Crew of an MSC ship
  4. A non-DOD contractor
- 1-60. What type or types of ID card, if any, would be issued to reserve personnel on inactive duty?
1. 2N, 2A, 2AF (Inactive)
  2. 2N, 2A, 2AF (Active)
  3. 2 (Retired)
  4. None
- 1-61. Which of the following identifications should be required by authorized users of postal privileges when the individual does not possess a military ID?
1. Drivers license
  2. American passport
  3. Travel orders
  4. Both 2 and 3 above

# ASSIGNMENT 2

Textbook Assignment: "Designations and Terminations," chapter 2, pages 2-1 through 2-14; and "Mail Packaging and Acceptance," chapter 3, pages 3-1 through 3-21.

---

- 2-1. Which of the following values are important to the military postal clerk when performing postal duties?
1. Integrity
  2. Neatness
  3. Trustworthy
  4. Punctuality
- 2-2. Military personnel selected for postal duties who have no previous postal experience should be scheduled to attend a postal course before assuming postal assignment.
1. True
  2. False
- 2-3. Which of the following documents are completed when designating military postal clerks (MPCs)?
1. DD Form 285
  2. DD Form 2257
  3. Page 13 entry
  4. Both 2 and 3 above
- 2-4. What official normally designates mail orderlies for units or divisions requiring mail orderly service?
1. Commanding Officer
  2. Department Head
  3. JMPA
  4. Cope
- 2-5. Division mail orderlies are charged with the delivery and safeguard of incoming accountable mail.
1. True
  2. False
- 2-6. Before assuming mail-handling duties, mail orderlies must be trained in which of the following subjects?
1. Importance of postal services
  2. Individual responsibilities
  3. Negative consequences for not following established procedures and instructions
  4. All of the above
- 2-7. What is the purpose of the DD Form 2260?
1. Record the appointment and revocation of mail orderlies
  2. Provide a record of assigned mail orderlies
  3. Both 1 and 2
  4. Used as a unit mail call sheet
- 2-8. Mail orderlies must carry their DD Form 285 at all times while performing mail-handling duties.
1. True
  2. False



- 2-9. What is the maximum number COPEs that can be assigned to a postal operation at one time?
1. One
  2. Two
  3. Three
  4. Four
- 2-10. During a change of COPE, who is responsible for completing the audit of postal effects?
1. The supply officer
  2. The disbursing officer
  3. The supply officer and disbursing officer
  4. The command monies audit board
- 2-11. The COPE and reserve custodian accounts have a tolerance limit of ten dollars.
1. True
  2. False
- 2-12. In the case of a temporary absence of the COPE, a temporary COPE must be designated if it exceeds what number of consecutive working days?
1. 5
  2. 10
  3. 15
  4. 30
- 2-13. Who is responsible for designating the command postal officer?
1. JMPA
  2. MPSA
  3. COMMANDING OFFICER
  4. EXECUTIVE OFFICER
- 2-14. Who is authorized to be designated as the command postal officer?
1. Commission officer
  2. Warrant Officer
  3. Chief Postal clerk
  4. All of the above
- 2-15. Commanding officers are responsible for ensuring that the commands postal effects are audited at what minimum frequency?
1. Daily
  2. Weekly
  3. Monthly
  4. Quarterly
- 2-16. Which of the following is not a reason for terminating a military postal clerks designation?
1. Discharge from military
  2. Change of rating
  3. Traffic ticket
  4. Theft
- 2-17. What number of years should you retain DD Form 2257 after termination?
1. One year
  2. Two years
  3. Three years
  4. Four years
- 2-18. When a COPEs designation is terminated and no qualified relief is present, who should take custody of the command's postal effects?
1. Commanding officer
  2. Executive officer
  3. Supply officer
  4. Reserve custodian

- 2-19. When a mail orderlies designation is terminated, what document should be revoked?
1. DD Form 285
  2. DD Form 885
  3. DD Form 2257
  4. DD Form 2865
- 2-20. What publication should you consult for packaging and wrapping requirements?
1. POM
  2. ASM
  3. T-7
  4. DMM
- 2-21. What is the number one safeguard to use in protecting parcels from damage?
1. Proper packaging of the parcel
  2. The purchase of special handling insurance
  3. Endorsing the parcel FRAGILE
  4. Mailing the parcel at the priority rate
- 2-22. Military postal clerks have what obligation to postal customers in wrapping their parcels?
1. Provide wrapping paper
  2. Provide adequate tape for parcel closure
  3. Provide appropriate shipping labels
  4. Provide guidance
- 2-23. What are the three types of loads used in the transportation industry and recognized by the USPS?
1. Easy, average, and heavy
  2. Light, average, and difficult
  3. Light, middleweight, and heavy
  4. Easy, average, and difficult
- 2-24. Which of the following would NOT be considered as an acceptable mailing container?
1. Chipboard
  2. Cardboard
  3. Metal can
  4. Fiber mailing tube with metal ends
- 2-25. It is recommended that a paper wrapper not be used if the box itself is adequate as a shipping container.
1. True
  2. False
- 2-26. Fiberboard tubes and similar long packages are acceptable containers provided which of the following criteria is met?
1. Their length does not exceed 10 times the girth of the article
  2. Their length does not exceed 5 times the girth of the article
  3. Their length does not exceed 3 times the girth of the article
  4. Their length does not exceed the length of the article enclosed
- 2-27. When cans or drums are mailed, which of the following closure methods is acceptable?
1. Tops are screwed on
  2. Tops are secured with bolts
  3. Tops are clamped on
  4. Each of the above
- 2-28. Metal cans and drums must be dispatched as outside pieces to make sure equipment and personnel are not injured?
1. True
  2. False

- 2-29. For cushioning of a package, you should use which of the following materials?
1. Shredded newspaper
  2. Foamed plastic
  3. Both 1 and 2 above
  4. Popcorn
- 2-30. For closure or reinforcement of packages, you should NOT use which of the following types of material?
1. Gummed tapes
  2. Pressure-sensitive tapes
  3. Adhesives and strapping materials
  4. Cellophane tapes and masking tapes
- 2-31. Except for pressure-sensitive filament tape, tapes used for closure or reinforcement should be at least how many inches wide?
1. 1 inch
  2. 2 inches
  3. 3 inches
  4. 4 inches
- 2-32. As a window clerk, you should NOT encourage customers to use twine or cord as a method of reinforcement. If twine or cord is used, it must be at least what stress strength?
1. 10 pounds
  2. 15 pounds
  3. 20 pounds
  4. 25 pounds
- 2-33. The markings on a package must be sharp and clear when viewed at what maximum distance?
1. 10 inches
  2. 5 inches
  3. 25 inches
  4. 30 inches
- 2-34. When markings or endorsements are used, they should be placed on what area of a package?
1. Below the address
  2. Above the address
  3. To the left and even with the address
  4. On the reverse side of the package
- 2-35. Which of the markings listed below is/are authorized on a mailing container?
1. A parcel marked as containing art supplies but actually containing a pair of socks
  2. A box that had imitation Postage stamps placed on the address side
  3. Order numbers placed in the area of the ZIP Code
  4. A parcel marked PRIORITY above the address
- 2-36. What organization is identified by the fourth and fifth digits of a nine-digit ZIP Code?
1. The local delivery area
  2. The sectional center facility
  3. The area distribution center
  4. The bulk mail center
- 2-37. Ships are assigned ZIP Codes based on which of the following factors?
1. Number of crewmembers assigned to each ship
  2. Geographic location of their home ports
  3. Both 1 and 2 above
  4. Volume of mail each ship receives
- 2-38. All ships receive mail through one of how many gateways?
1. One
  2. Two
  3. Three
  4. Four

2-39. The FPO address assigned a ship depends upon what factor, if any?

1. The size of the ship
2. The amount of personnel assigned
3. The ship's home port
4. None

- |           |
|-----------|
| A. FPO AA |
| B. FPO AE |
| C. FPO AP |

IN ANSWERING QUESTIONS 2-40 THROUGH 2-43, SELECT THE FPO ADDRESS IN THE TEXT BOX THAT IS CORRECT FOR THE UNIT'S HOME PORT GIVEN IN THE QUESTION.

2-40. Norfolk, VA.

1. A
2. B
3. C

2-41. San Diego, CA.

1. A
2. B
3. C

2-42. Mayport, FL.

1. A
2. B
3. C

2-43. Bremerton, WA.

1. A
2. B
3. C

2-44. Which of the following publications list(s) the correct mailing addresses of Navy activities, ships, and other mobile units?

1. The Standard Navy Distribution List, part 1
2. The Standard Navy Distribution List, part 2
3. Both 1 and 2 above
4. The Mail Distribution Instructions and Labeling Handbook

2-45. Which of the following addressing procedures is/are NOT considered acceptable?

1. Two or more addresses on the same article
2. More than one post office appears in the return address
3. An article has instructions to return to point of mailing
4. All of the above

2-46. Where should the ZIP Code be placed on a letter that is mailed to a US address?

1. On the last line of address following the city and state
2. On the last line of address following the city and in front of the state
3. On the last line of address in front of the city and state
4. As the bottom line of the address below the city and state

2-47. When the state name is abbreviated, the use of a period after the name and before the ZIP Code is not required.

1. True
2. False

- 2-48. A mailer may request a certain length of time that a piece of mail should be held before returning it to the mailer. Where on the mailing container should this request appear?
1. Above the return address
  2. Below the return address
  3. Above the addressee's address
  4. Below the addressee's address
- 2-49. Whenever box or division numbers are used as part of the address, they should normally be included on what line of the address?
1. First
  2. Second
  3. Third
  4. Fourth
- 2-50. Which of the following military addresses is NOT a correct address?
1. CTF 77, FPO AE 09501
  2. Fighter Squadron 12 (VF12), FPO AE 09501
  3. VP-44, FPO AP 96601
  4. USS NEVERSAIL (DDG-10) FPO AE 09566
- 2-51. Mail should not be addressed to task forces, groups, or units by task organization numbers unless so listed in the SNDL.
1. True
  2. False
- 2-52. The use of an FPO ZIP Code provides which of the following benefits?
1. Affords greater control of mail
  2. Qualifies mail for domestic postal rates
  3. A uniform system for addressing mail
  4. All of the above
- 2-53. The postal concentration centers are furnished with proper routing and dispatching instructions for deployed ships by what organization?
1. MPSA
  2. JMPA
  3. FLTCINC
  4. NAVSUP
- 2-54. Which, if any, of the following special services may be provided for Department of State addresses?
1. C.O.D.
  2. Registered
  3. Insured
  4. None of the above
- 2-55. Keeping nonmailable and potential harmful and dangerous matter from the mail is the responsibility of what person(s)?
1. The military postal clerk only
  2. The mailer only
  3. The military postal clerk and the mailer
  4. The postal officer
- 2-56. Which of the following personnel may exclude questionable written, printed, or graphic matter from the mails?
1. Window clerk
  2. COPE
  3. Postal officer
  4. None of the above
- 2-57. An article may be nonmailable because it does not comply with postal regulations in regard to which of the following situations?
1. Preparation
  2. Size
  3. Weight
  4. All of the above

2-58. A flammable liquid may be accepted in the domestic surface mail under what condition?

1. Its flash point is between 20°F and 100°F
2. Its flash point is between 25°F and 105°F
3. Its flash point is between 30°F and 110°F
4. Its flash point is between 40°F and 120°F

2-59. Combustible liquids can be accepted for Mailing if they meet the requirements in what module of the DMM?

1. A
2. C
3. P
4. R

2-60. Although accepted by USPS in the domestic mail system, which of the following articles are NOT accepted in the Military Postal System?

1. Matches
2. Class B poisons
3. Narcotic drugs
4. Switchblade knives

A. Possible unique characteristic of a package or letter containing a bomb.

B. Probably would not be a unique characteristic or appear on the

2-61 An endorsement is indicated on the wrapper as Private.

1. A
2. B

2-62. The addressee's official title is inaccurate on the envelope of a letter.

1. A
2. B

2-63 The parcel is making a buzzing noise.

1. A
2. B

2-64. If an article is suspected of being a letter bomb, which, if any, of the following is NOT recommended as a precautionary measure?

1. Put the article in a bucket of water
2. Put the article in a desk drawer
3. Put the article in a file cabinet
4. Each of the above

2-65. Which of the following conditions must occur before a battery-powered device is considered mailable?

1. The batteries have to be removed
2. The batteries have to be deactivated
3. Either 1 or 2 above, depending on the desires of the mailer
4. The device must contain liquid electrolyte batteries

2-66. Any parcel containing firearms, switchblade knives, or controlled substances should not have any marking on the outside wrapper or container that would indicate the nature of the contents.

1. True
2. False

IN ANSWERING QUESTIONS 2-61 THROUGH 2-63, SELECT THE CATEGORY FROM THE TEXT BOX THAT IS INDICATIVE OF THE DESCRIPTIVE ATTRIBUTE IN THE QUESTION. EACH RESPONSE MAY NOT BE USED.

- 2-67. Before a licensed manufacturer can mail a firearm, what form must be filed at the mailing post office?
1. PS Form 1508
  2. PS Form 1509
  3. PS Form 1510
  4. PS Form 1518
- 2-68. A shotgun is nonmailable if the barrel(s) is/are less than what overall length?
1. 18 inches
  2. 20 inches
  3. 26 inches
  4. 30 inches
- 2-69. An antique firearm is any firearm manufactured in or before what year?
1. 1776
  2. 1898
  3. 1900
  4. 1909
- 2-70. When an article that is addressed to an APO or FPO is presented for mailing, what publication should be checked for possible mailing restrictions?
1. DOD Postal Manual, Conditions Applied to Mail Addressed to Military Post Offices Overseas
  2. DMM, Conditions Applied to Mail Addressed to Military Post Offices Overseas
  3. Postal Bulletin, Conditions Applied to Mail Addressed to Military Post Offices Overseas
  4. T-7, Conditions Applied to Mail Addressed to Military Post Offices Overseas
- 2-71. Scales used at postal finance window should be checked for accuracy at what minimum frequency?
1. Daily
  2. Weekly
  3. Monthly
  4. Quarterly
- 2-72. Navy post offices should have calculators that have the ability to print tapes?
1. True
  2. False

# ASSIGNMENT 3

Textbook Assignment: "Domestic Mail," chapter 4, pages 4-1 through 4-23, and "Special Services," chapter 5, pages 5-1 through 5-14.

---

- 3-1. Which description below best describes the definition of domestic mail?
1. Mail transmitted within, among, and between the United States only
  2. Mail transmitted within, among, and between the United States, its territories, and possessions only
  3. Mail transmitted within, among and between the United States, its territories, and possessions; and APOs and FPOs only
  4. Mail transmitted within, among, and between the United States, its territories and possessions; APOs and FPOs; and mail for delivery to the United Nations, New York
- 3-2. Which of the following factors determine(s) the class of domestic mail into which an article will be classified?
1. Size only
  2. Contents only
  3. Size, weight, and contents
  4. Contents, weight, and desired service
- 3-3. Domestic mail is divided into how many different classes?
1. Five
  2. Two
  3. Three
  4. Four
- 3-4. What is the girth of the parcel?
1. 50 inches
  2. 25 inches
  3. 66 inches
  4. 40 inches
- 3-5. What is the combined length and girth of the parcel?
1. 53 inches
  2. 78 inches
  3. 80 inches
  4. 106 inches
- 3-6. Which of the following parcels exceeds the maximum length and girth of 108 inches?
1. 28" long by 20" wide by 5" high
  2. 36" long by 20" wide by 20" high
  3. 42" long by 20" wide by 8" high
  4. 48" long by 15" wide by 10" high
- 3-7. If a package is in the shape of a cone, the girth is measured at its base.
1. True
  2. False
- 3-8. Which of the following envelopes allows EMMS users to place as much merchandise in the envelope as it will hold but only be charged the two-pound rate of postage?
1. EP11B
  2. EP11G
  3. EP13A
  4. EP13F

USE THE FOLLOWING MEASUREMENTS TO ANSWER QUESTIONS 3-4 AND 3-5. YOU ARE PRESENTED A RECTANGULAR PARCEL MEASURING 28" LONG BY 20" WIDE BY 5" HIGH.



3-9. As a general rule, all mailable matter can be sent as First-Class Mail if the proper amount of postage is paid

1. True
2. False

3-10. Which of the following items are NOT considered First-Class matter?

1. Post cards
2. Magazines
3. Handwritten letters
4. Typewritten letters

3-11. The zone rate (priority) is charged for First-Class Mail if the article exceeds what weight?

1. 8 ounces
2. 10 ounces
3. 12 ounces
4. 13 ounces

3-12. Articles mailed at the First-Class (priority) zone rate of postage must not exceed what maximum weight?

1. 50 pounds
2. 60 pounds
3. 70 pounds
4. 80 pounds

3-13. Articles mailed at the First-Class (priority) zone rate of postage must not exceed what length and girth combined?

1. 108 inches
2. 80 inches
3. 60 inches
4. 40 inches

3-14. Postage for First-Class zone rated (priority) articles is determined by which of the following factors?

1. Contents and distance it must travel only
2. Weight and distance it must travel only
3. Weight, contents, and distance it must travel
4. Weight, contents, and the origin of the articles

- |  |
|--|
| <ol style="list-style-type: none"><li>A. Local</li><li>B. First</li><li>C. Fifth</li><li>D. Eighth</li></ol> |
|--|

THE U.S. POSTAL SERVICE HAS DIVIDED THE UNITED STATES AND ITS TERRITORIES INTO A LOCAL ZONE PLUS EIGHT OTHERS. IN ANSWERING QUESTIONS 3-15 THROUGH 3-17, SELECT THE CORRECT POSTAL ZONE LISTED IN THE TEXT FOR THE DEFINITION GIVEN IN THE QUESTIONS. ALL RESPONSES ARE USED.

3-15. Parcels mailed and delivered by same post office.

1. A
2. B
3. C
4. D

3-16. Includes all units of area outside zone seven.

1. A
2. B
3. C
4. D

3-17. Includes all units of area outside zone four lying in whole or in part within a radius of about 1,000 miles from the center of a given unit of area.

1. A
2. B
3. C
4. D

3-18. Articles mailed at the First-Class letter rate of postage must not exceed what maximum weight?

1. 10 ounces
2. 11 ounces
3. 12 ounces
4. 13 ounces

IN ANSWERING QUESTIONS 3-19 AND 3-20, REFER TO FIGURE 4-3 IN YOUR TEXTBOOK AND ASSUME THAT YOUR OFFICE OF MAILING IS ZIP CODE 96615.

3-19. In what zone is Presque Isle, Maine 04769?

1. Fifth
2. Sixth
3. Seventh
4. Eighth

3-20. In what zone is Hamlin, West Virginia 25523?

1. Fifth
2. Sixth
3. Seventh
4. Eighth

3-21. Two packages may be mailed as one single parcel if which of the following requirements are met?

1. If the two parcels are the same size in length and girth only
2. If the two parcels are the exact same item only
3. Both 1 and 2 above
4. If the packages are about the same size or shape or they are integral part of one article

3-22. Which of the following parcels would be charged the rate equal to that of a 15-pound parcel?

1. A parcel that weighs 14 pounds and has a combined length and girth of 72 inches
2. A parcel that weighs 6 pounds and has a combined length and girth of 96 inches
3. A parcel that weighs 10 pounds, and has a combined length and girth of 83 inches
4. A parcel that weighs 5 pounds and has a combined length and girth of 72 inches

3-23. What sticker(s) must be attached to a priority parcel to promote the use of priority mail?

1. PS Label 106
2. PS Label 106-A
3. PS Label 107
4. All of the above

3-24. Which of the following items would normally qualify for mailing at the Periodicals rate?

1. Newspapers
2. Magazines
3. Periodicals published frequently
4. All of the above

- 3-25. Standard Mail is broken down into how many classes?
1. One
  2. Two
  3. Three
  4. Four
- 3-26. Standard Mail (B) consists of which of the following types of mail?
1. Parcel Post
  2. Periodicals
  3. EMMS
  4. None of the Above
- 3-27. At MPOs, Standard Mail (B) is commonly known as what type of mail?
1. PAL
  2. SAM
  3. Special Standard Mail
  4. Parcel Post
- 3-28. What addressing information is required on Standard Mail (B)?
1. The complete address, including the ZIP Code, of the addressee on all sides of the parcel
  2. The complete addresses, including the ZIP Codes, of the addressee and mailer on one side of the parcel
  3. The complete addresses, including the ZIP codes, of the addressee and the mailer on the address side and the reverse side of the parcel
  4. An addressee's address, including the ZIP Code, on one side and the mailers address with ZIP Code on the reverse side of the parcel
- 3-29. Articles mailed at the Standard Mail (B) rate of postage may be subject to inspection under certain conditions whether or not the mail piece is secured.
1. True
  2. False
- 3-30. When placed in or on a parcel mailed Standard Mail (B), which of the following written additions and enclosures does NOT require additional First-Class postage?
1. Matter mailable as Standard Mail (A) printed on the wrapper
  2. The words "Please Do Not Open Until Christmas" inscribed on the wrapper
  3. Instructions for the use of the item mailed in writing as an enclosure
  4. Each of the above
- 3-31. What is the maximum weight limit for Standard Mail (B)?
1. 15 pounds
  2. 30 pounds
  3. 60 pounds
  4. 70 pounds
- 3-32. When accepting Standard Mail (B) you should refer to the Conditions Applied to Mail Addressed to Military Post Offices Overseas located in what document?
1. Module A of the DMM
  2. USPS Postal Bulletin
  3. Section 131 of the POM
  4. Section 136 of the ASM
- 3-33. What is the maximum size limit for Parcel Post (Oversized Mail)?
1. 60 inches
  2. 100 inches
  3. 108 inches
  4. 130 inches
- 3-34. Postage for Standard Mail (B) is determined by which of the following?
1. Size and distance it must travel
  2. Distance it must travel and contents
  3. Weight and distance it must travel
  4. Weight and content

- 3-35. When a parcel presented for mailing is determined to be outside your serving BMC, which of the following factors must then be considered to compute the proper postage?
1. Weight
  2. If the parcel is machinable or nonmachinable
  3. Size
  4. If the parcel has any notation or endorsements inscribed on the outside
- 3-36. Which of the following articles should be dispatched as an outside piece (not sackable)?
1. A parcel that has been damaged already in the mails
  2. A tube less than 26 inches long
  3. A glass container with 25 ounces of liquid
  4. All of the above
- 3-37. If an article is addressed for delivery within the delivery area of your serving BMC, you should charge the Standard Mail (B) rate with a discount.
1. True
  2. False
- 3-38. A machinable article that is addressed for delivery outside the delivery area of your serving BMC should be charged the applicable fourth-class rate with a surcharge applied.
1. True
  2. False
- 3-39. A nonmachinable article that is addressed for delivery outside the delivery area of your serving BMC should be charged the applicable Standard Mail (B) rate without a surcharge applied.
1. True
  2. False
- 3-40. A nonmachinable article, on which a special handling fee has been paid, addressed for delivery outside your serving BMC, should be charged the applicable Standard Mail (B) rate without a surcharge applied.
1. True
  2. False
- 3-41. A SAM article mailed from one of the 48 contiguous states to an overseas military post office has what maximum weight limit?
1. 5 pounds
  2. 10 pounds
  3. 15 pounds
  4. 30 pounds
- 3-42. What is the maximum size limit for articles sent PAL?
1. 20 inches in length and girth combined
  2. 40 inches in length and girth combined
  3. 60 inches in length and girth combined
  4. 80 inches in length and girth combined
- 3-43. PAL mail must not exceed what maximum weight?
1. 15 pounds
  2. 20 pounds
  3. 30 pounds
  4. 45 pounds
- 3-44. The amount of postage charged for Special Standard Mail is determined by what factor(s)?
1. Weight only
  2. Size only
  3. Weight and size
  4. Contents

- 3-45. Articles mailed as Special Standard Mail should have what endorsement(s) on the outside wrapper?
1. Special Standard Mail only
  2. SAM only
  3. Special Standard Mail and SAM
  4. Special rate
- 3-46. Which of the following types of Standard Mail may be sent at the library rate?
1. A book that contains advertisements
  2. Printed music
  3. A letter addressed to a college
  4. A Magazine addressed to an individual recipient from a vendor
- 3-47. Which of the following articles mailed from an MPO overseas is subject to customs examination when entering the U.S.?
1. A \$5 wood carving
  2. A \$50 watch
  3. A \$500 TV
  4. Each of the above
- 3-48. Which of the following individuals is responsible for compliance with customs laws when a parcel is mailed to a CONUS address from an MPO overseas?
1. The mailer
  2. The accepting military postal clerk
  3. The postal supervisor
  4. The commanding officer
- 3-49. Which of the following individuals is responsible for accurately listing the contents and value of each article mailed at an MPO overseas?
1. The mailer
  2. The accepting clerk
  3. The customs petty officer
  4. The COPE
- 3-50. Which of the following statements best describes the military postal clerk's role in compliance with customs law?
1. MPCs are totally responsible
  2. MPCs have no responsibility
  3. MPCs are responsible for ensuring the customs form is properly completed and attached
  4. MPCs are responsible to the commanding officer for the compliance of customs laws
- 3-51. Which of the following customs forms would a customer use when sending a parcel from an overseas MPO to the U.S. with a declared value of \$401?
1. PS Form 2976
  2. PS Form 2976-A
  3. PS Form 2976-E
  4. None of the above
- 3-52. When a customer is sending personal property to the U.S. from an overseas MPO what endorsement is placed on the address side of the parcel?
1. FREE FROM DUTY—PERSONAL PROPERTY ENCLOSED
  2. UNSOLICITED GIFT
  3. RETURNED PERSONAL PROPERTY—ORDERS ENCLOSED
  4. AMERICAN GOODS RETURNED
- 3-53. The use of certified mail provides which of the following benefits?
1. The post office of origin with a record of delivery
  2. The mailer with a receipt for proof of mailing
  3. The post office of address with a record of delivery
  4. Both 2 and 3 above

- 3-54. Which of the following types of mailable matter may be certified?
1. A letter with a U.S. postal money order enclosed addressed to New York City
  2. A letter addressed to Rota, Spain
  3. A letter addressed to London, England
  4. All of the above
- 3-55. Certified mail may be put in mail drops or street collection boxes, provided all postage and fees are prepaid.
1. True
  2. False
- 3-56. Postal insurance service with an article provides the customer with what service?
1. Special safeguards of the article during transit
  2. Reimbursement if the article is lost or damaged
  3. A record of delivery
  4. Expedient handling of the article while in transit
- 3-57. Which of the following mail is NOT insurable?
1. Standard Mail (B)
  2. Standard Mail matter mailed at the First-Class rate of postage
  3. Standard Mail matter mailed at the Priority rate of postage
  4. None of the above
- 3-58. On a parcel that is sent unnumbered insured, where do you place the endorsement, and what type of stamp do you use?
1. Above the address with an elliptical stamp
  2. To the left of the address with the INSURED NO. stamp
  3. Top center on the address side with the elliptical stamp
  4. To the left of the address with an elliptical stamp
- 3-59. The fee for numbered insured mail is based on the liability coverage requested. In what publication can you find these amounts?
1. ASM
  2. DOD Postal Manual volume I
  3. DMM
  4. OPNAV Postal Instruction
- 3-60. When the numbered insured form is completed, the stub to the left of the form is detached. What should be done with the sticker?
1. Given to the customer
  2. Placed on the article being insured
  3. Destroyed by the accepting clerk
  4. Filed in post office records for accountability
- 3-61. Special handling is available for which of the following classes of mail?
1. First-Class
  2. Priority mail
  3. Standard Mail (B)
  4. All of the above
- 3-62. Special handling can be combined with which of the following special services?
1. Certified mail
  2. Insured mail
  3. Return receipt for merchandise
  4. Both 2 and 3 above

3-63. For which of the following purposes may an individual pay a fee and obtain a certificate of mailing?

1. To provide for indemnity in case of loss or damage
2. To furnish evidence of mailing
3. To furnish proof of delivery to the addressee
4. Each of the above

3-64. Return receipt service may be used with which of the following special services?

1. Certified
2. Numbered insured mail
3. Certificate of mailing
4. Unnumbered insured mail

3-65. Based on the customer's desires, a return receipt can provide which of the following services?

1. Signature of addressee or agent and date of delivery
2. Signature, date, and the addressee's address where delivered
3. Both 1 and 2 above
4. Signature of addressee and date of delivery only

3-66. When delivery only to a specific person is requested, the mailer should use which of the following special services?

1. Special handling
2. Certified mail
3. Restricted delivery
4. Numbered insured

- |    |                |
|----|----------------|
| A. | PS Form 3800   |
| B. | PS Form 3813   |
| C. | PS Form 3813-P |
| D. | PS Form 3817   |
| E. | PS Form 3811   |
| F. | PS Form 3811-A |
| G. | PS Form 3804   |

IN ANSWERING QUESTIONS 3-67 THROUGH 3-75, SELECT FROM THE TEXT BOX THE PS FORM THAT REPRESENTS THE SERVICE LISTED IN THE QUESTIONS. EACH RESPONSE IS USED AT LEAST ONCE.

3-67. Provides the mailer with a return receipt after mailing.

1. B
2. D
3. F
4. G

3-68. Provides the mailer with a receipt for mailing numbered insured mail.

1. A
2. B
3. C
4. F

3-69. Provides the mailer with the signature of the addressee and date of delivery.

1. D
2. E
3. F
4. G

3-70. Provides the mailer with proof of deposit into the mails.

1. A
2. B
3. D
4. G

3-71. Provides the mailer with a mailing receipt, signature of the addressee and date of delivery, and a record of delivery is maintained at the office of delivery.

1. A
2. D
3. F
4. G

3-72. Provides the mailer a duplicate return receipt when the original is not received.

1. D
2. E
3. F
4. G

3-73. Provides the mailer with a mailing receipt and a record of delivery is maintained at the office of delivery.

1. A
2. C
3. E
4. F

3-74. Mailer can use this form to request delivery information concerning an accountable mail piece.

1. C
2. D
3. E
4. F

3-75. Provides the mailer with indemnity coverage for the mail piece but no record of delivery is maintained at the office of delivery.

1. B
2. C
3. E
4. F



# ASSIGNMENT 4

Textbook Assignment: "International Mail," chapter 6, pages 6-1 through 6-23.

---

- 4-1. The regulations that apply to international mail service are contained in what publication?
1. The International Mail Manual
  2. The Domestic Mail Manual
  3. The Department of Defense Postal Manual
  4. The Postal Operations Manual
- 4-2. A military postal clerk should be primarily concerned with which of the following chapters of the International Mail Manual?
1. Chapters 1, 2, and 4
  2. Chapters 2, 3, and 4
  3. Chapters 2, 3, and 5
  4. Chapters 1, 2, and 3
- 4-3. Information in the IMM is listed by what type of numbering system?
1. Arabic
  2. Decimal-type
  3. Roman
  4. None of the above
- 4-4. What part of the IMM would list a country not listed separately in the Individual Country Listings?
1. International Mail Services
  2. Treatment of Outbound Mail
  3. World Map
  4. Index of Countries and Localities
- 4-5. Which of the following International mail categories is not available at military postal facilities?
1. Parcel Post
  2. Express Mail International Service
  3. Postal Union
  4. All of the above
- 4-6. Postal union mail is divided into what two types?
1. LC and AO mail
  2. LC and parcel post
  3. Parcel post and airmail
  4. Parcel post and AO mail
- 4-7. Articles that are nonmailable in the domestic mail are prohibited in the international mail.
1. True
  2. False
- 4-8. To ensure articles presented for mailing in the international postal service are mailable, you should refer to which of the following publications?
1. Module C of the DMM only
  2. Individual Country Listing of the IMM
  3. Both 1 and 2 above
  4. Handbook T-7
- 4-9. Costume jewelry articles are prohibited in postal union mail unless registered.
1. True
  2. False

- 4-10. If an article is not prohibited or restricted in the international mail system, you should still check the individual country listing for possible specific country restrictions.
1. True
  2. False
- 4-11. Which of the following types of envelopes are NOT acceptable for mailing to a foreign country?
1. Highly glazed paper envelopes
  2. Envelopes that are 2 1/2 inches High
  3. Envelopes that are 4 3/4 inches long
  4. All of the above
- 4-12. Envelopes that are addressed to a foreign country should meet which of the following criteria?
1. Be light in color
  2. Be rectangular in shape
  3. Have a minimum size of 3 1/2 inches by 5 1/2 inches
  4. All of the above
- 4-13. Certain types of postal union mail should be prepared so that the contents can easily be inspected. Which of the following types of postal union mail is/are in that category?
1. Letter packages
  2. Small packets
  3. Printed matter
  4. Both 2 and 3 above
- 4-14. Postal union mail must be addressed in what manner?
1. The name and address of the addressee must be complete
  2. The house number and street address must be included
  3. Both 1 and 2 above
  4. If addressed in Russian, an English translation is not needed
- 4-15. International items must be fully prepaid to assure prompt dispatch to the addressee.
1. True
  2. False
- 4-16. Meter stamps used on international mail should be what color?
1. Blue
  2. Yellow
  3. Green
  4. Red
- 4-17. The weight limit for letters and letter packages to most countries is what maximum amount?
1. 10 pounds
  2. 20 pounds
  3. 44 pounds
  4. 4 pounds
- 4-18. Letters and letter packages may be sent sealed or unsealed unless sent by which of the following methods?
1. Parcel Post
  2. Registered mail
  3. Airmail
  4. None of the above
- 4-19. Attaching PS Label 19-A to airmail articles is the responsibility of what individual?
1. The mailer
  2. The accepting military postal clerk
  3. The customs official
  4. The COPE
- 4-20. The basic requirements for postcards accepted in the international mail is the same as those for domestic mail.
1. True
  2. False

- 4-21. Which of the following matter may NOT be affixed to the back of a post card?
1. Merchandise samples
  2. Photographs
  3. News clippings
  4. Labels
- 4-22. Which, if any, of the following is the correct minimum size limit for post cards mailed to a foreign country?
1. 4 1/4 inches by 6 inches
  2. 3 1/2 inches by 5 inches
  3. 3 1/2 inches by 5 1/2 inches
  4. None of the above
- 4-23. Aerogrammes with enclosures on which postage has not been paid at the airmail letter rate must be sent as surface mail.
1. True
  2. False
- 4-24. Postal union printed matter is divided into what specific number of categories?
1. One
  2. Two
  3. Three
  4. Four
- 4-25. Which of the following is NOT a authorized endorsement for printed matter?
1. BOOKS—PRINTED MATTER
  2. PRINTED MATTER
  3. PRINTED MATTER—BOOKS
  4. PRINTED MATTER—SHEET MUSIC
- 4-26. Matter for the blind articles has what maximum weight limit?
1. 5 pounds
  2. 10 pounds
  3. 15 pounds
  4. 20 pounds
- 4-27. Articles accepted as matter for the blind must be prepared in such a way that the contents are protected but inspection of the contents is not hindered.
1. True
  2. False
- 4-28. Matter for the blind accepted as surface mail must be unsealed and in the upper right corner have what notation?
1. MATTER FOR THE BLIND
  2. FREE above MATTER FOR THE BLIND
  3. POSTAL UNION above MATTER FOR THE BLIND
  4. MATTER FOR THE BLIND above FREE
- 4-29. Which of the following items may be enclosed inside a small packet?
1. Jewelry
  2. Coins
  3. Video tapes
  4. Paper Money
- 4-30. Which of the following articles may NOT be included in small packets?
1. Phonographic records
  2. Sound tapes
  3. Personal correspondence
  4. Magnetic tapes
- 4-31. Whether or not they are subject to customs inspection, small packets must bear which of the following customs forms?
1. PS Form 2976
  2. PS Form 2976-A
  3. Either 1 or 2 above
  4. None of the above

- 4-32. The exchange of parcel post with the United States and countries is governed by which of the following agreements?
1. DOD and USPS postal agreement
  2. Individual bilateral agreements between the United States and each foreign country
  3. MPSA and USPS postal agreement
  4. All of the above
- 4-33. In the preparation of parcels for international mail, the military postal clerk is responsible for which of the following functions?
1. Enclosing, packaging, and sealing the parcels properly
  2. Making all the proper requirements available to and assisting the mailer in the package preparation
  3. Informing the mailer that the contents are subject to the import rules of the country concerned
  4. None of the above
- 4-34. A letter may be attached to an international parcel post article being mailed to which of the following countries?
1. England
  2. Canada
  3. Switzerland
  4. Both 2 and 3 above
- 4-35. Which, if any, of the following weight limits listed below is the maximum that an international parcel may weigh for acceptance?
1. 32 pounds
  2. 22 pounds
  3. 44 pounds
  4. None, Maximum weight varies from country to country
- 4-36. Which of the following containers are NOT acceptable for international parcel post?
1. Ordinary paperboard boxes
  2. Solid fiber boxes
  3. Three-ply plywood boxes
  4. Double-faced corrugated cardboard boxes
- 4-37. You should NOT accept an international parcel that has been addressed by which of the following means?
1. Ink
  2. Typewriter
  3. Lead pencil
  4. Indelible pencil
- 4-38. Which of the following, if any, is/are the only method(s) of transportation available for sending parcels and letters to foreign countries?
1. Air only
  2. Surface only
  3. Air or surface depending on the wishes of the customer
  4. None of the above
- 4-39. Dutiable Postal Union and Parcel Post Mail require which of the following customs form(s) if any?
1. PS Form 2976 only
  2. PS Form 2976-A only
  3. PS Form 2976 or PS Form 2976-A
  4. None of the above

- 4-40. Your ship is on deployment in the Indian Ocean and you receive an ordinary parcel with a CF 3419-A attached, what should you do?
1. Deliver the article on PS Form 3849 only
  2. Notify the addressee by preparing a PS Form 3849, when picked up collect customs duty assessed and forward along with CF 3419-A to the applicable postmaster
  3. Remove CF 3419-A and endorse Delivered Outside The CTUS, return form to issuing customs office, and deliver Parcel to addressee
  4. Deliver the article on CF 3419-A only
- 4-41. To prevent the addressee from paying customs duty, the sender can prepay duty abroad at the office of mailing.
1. True
  2. False
- 4-42. A customer received a parcel that has a CF 3419-A attached with customs duty assessed. The customer wishes to protest the customs charges. What publication should you refer to for instructions?
1. ASM
  2. IMM
  3. Reverse side of the CF 3419-A
  4. Both 2 and 3 above
- 4-43. Certificates of mailing are available for international mail only when sent registered mail.
1. True
  2. False
- 4-44. Which of the following types of international mail may be insured?
1. Letter packages
  2. Parcel post
  3. Small packets
  4. All of the above
- 4-45. You have accepted a parcel with a declared value of \$75 that is \$25 less than the maximum limit of the country concerned. At the mailer's request you can NOT insure the parcel for which of the following amounts?
1. \$25
  2. \$50
  3. \$75
  4. \$100
- 4-46. All international insured parcels must be sealed.
1. True
  2. False
- 4-47. When insurance on international mail is provided, what PS form is used?
1. PS Form 17
  2. PS Form 3602
  3. PS Form 3800
  4. PS Form 3813-P
- 4-48. The amount for which an international parcel is insured must be shown on the address side in U.S. currency and SDR equivalent.
1. True
  2. False

- 4-49. Indemnity for a single article of lost registered mail is generally limited to what, maximum amount?
1. \$15.61
  2. \$20.40
  3. \$25.68
  4. \$40.45
- 4-50. Which of the following types of international mail should NOT be accepted for registration?
1. A letter enclosed in a self-sealed envelope
  2. Matter for the blind, sealed with wax
  3. A sealed parcel post article
  4. All of the above
- 4-51. When an international article is registered, what PS form is issued to the mailer as a receipt?
1. PS Form 3806
  2. PS Form 3811
  3. PS Form 3813
  4. PS Form 3813-P30
- 4-52. When endorsing a registered article, (a) what is used as an endorsement and (b) where is the endorsement placed?
1. (a) The word REGISTERED with the registration number below (b) placed in the lower left corner on the face of the article
  2. (a) PS Label 200 (b) placed in the lower left corner on the face of the article
  3. (a) A capital letter R with the registration number to the right (b) placed between the addressee's address and the postage on the face of the article
  4. (a) PS Label 200 (b) placed between the addressee's address and the postage on the face of the article
- 4-53. The last step in accepting an international registered article is to postmark. With what device, if any, do you cancel the postage?
1. Killer bar
  2. APDS
  3. Killer bar or APDS depending on local policy
  4. None
- 4-54. What is the PS form number for an International Return Receipt?
1. PS Form 2685
  2. PS Form 2865
  3. PS Form 2568
  4. PS Form 2856
- 4-55. At the time of mailing a registered letter to a foreign country, the mailer requests a return receipt. In preparing the letter for mailing, you should NOT take which of the following steps?
1. Complete the front of the PS Form 2865
  2. Compute postage for the return receipt fee on the letter
  3. Include the weight of the return receipt in determining postage on the letter
  4. Endorse the letter on the address side AVIS DE RECEPCION
- 4-56. For countries that provide the service, restricted delivery is available only when which of the following is met?
1. For registered or recorded delivery items
  2. If accompanied by a return receipt
  3. If requested at the time of mailing
  4. All the above

- 4-57. Recall or change of address of international mail can NOT be performed at which of the following locations.
1. The office of mailing
  2. The bulk mail center
  3. The country of end destination
  4. The U.S. dispatching exchange office
- 4-58. Special delivery service is limited to postal union mail in the international mail system.
1. True
  2. False
- 4-59. In place of PS Label 57, what endorsement can the mailer place on the face of an article to indicate international special delivery service?
1. Asegurado
  2. Certificado
  3. Wertpaket
  4. EXPRES - Special Delivery
- 4-60. International mail that may be afforded special handling service includes which of the following types?
1. Air parcel post
  2. Surface parcel post
  3. Surface small packets
  4. Both 2 and 3 above
- 4-61. Special handling packages are given preferential handling during which of the following phases?
1. From the exchange or terminal office in the United States to the foreign country
  2. In the postal service of the country of destination
  3. From the post office of mailing to the U.S. office of dispatch
  4. All of the above
- 4-62. In what location should an international article be endorsed for special handling?
1. In the lower left corner
  2. Immediately above the name of the addressee and below the stamps
  3. In the lower right corner
  4. Anywhere on the address side of the wrapper
- 4-63. Recorded delivery is the international service equivalent to which of the following domestic mail special services?
1. Numbered insured
  2. Certified
  3. Unnumbered insured
  4. Certificate of mailing
- 4-64. Recorded delivery provides all but which of the following services?
1. The mailer with a numbered receipt
  2. The destination post office with a record of delivery
  3. Both 1 and 2 above
  4. The originating post office with a record of mailing
- 4-65. International reply coupons offer individuals a means of obtaining postage from post offices in foreign countries.
1. True
  2. False

# ASSIGNMENT 5

Textbook Assignment: "Registered Mail," chapter 7, pages 7-1 through 7-26.

---

- 5-1. Registered mail provides which of the following benefits?
1. Incorporates a system of receipts to monitor its movement
  2. Evidence of mailing and delivery
  3. Security for valuable and important mail
  4. All of the above
- 5-2. At what class of postage must an article be prepaid before it may be registered?
1. First-Class mail
  2. Priority mail
  3. Both 1 and 2 above
  4. Standard Mail
- 5-3. An article will not be registered if the item consists of two or more pieces that are tied or fastened together unless the pieces are in the same envelope or wrapper.
1. True
  2. False
- 5-4. Which of the following factors determines the fee for registering an article?
1. Weight of the article
  2. Distance the article is to be sent.
  3. Amount of ordinary postage required
  4. Declared value of the article
- 5-5. If a registered article is lost, what maximum amount of indemnity may be paid to the mailer?
1. \$10,000
  2. \$15,000
  3. \$20,000
  4. \$25,000
- 5-6. When the value for a registered article is declared, which of the following items is/are considered a nonnegotiable instrument?
1. Money
  2. Gems
  3. Income tax check
  4. Stereo equipment
- 5-7. Which of the following items may be accepted for registration?
1. A letter enclosed in a self-sealing envelope
  2. A package sealed with masking tape
  3. A transparent panel envelope containing \$20 in cash
  4. A package sealed with either paper or cloth tape



5-8. Which of the following procedures applies to the assignment of registration numbers?

1. Numbers are allotted by the U.S. Postal Service and are preprinted in an OCR readable print with the letters RR followed by nine digits and end with the letters US
2. Numbers are prepared locally and begin with the number 1 on the first day of the fiscal year
3. Numbers are assigned by the Navy Department and commence with the number 1 on the first day of the calendar year
4. None of the above

5-9. Which of the following services may a mailer request along with registration if any?

1. Return receipt
2. Restricted delivery
3. Both 1 and 2 above
4. None of the above

5-10. During what stage of the registration transaction is the article considered registered?

1. After a completed PS Form 3806 has been issued to the customer
2. After the customer completes the lower half of the PS Form 3806
3. After the accepting clerk completes the upper half of PS Form 3806
4. After the accepting clerk enters the registered number on PS Form 3806

REFER TO FIGURE 7-6 OF YOUR NRTC WHEN COMPLETING QUESTION 5-11.

5-11. When postal insurance is requested for registration, what block is checked on PS Form 3806?

1. Block 5
2. Block 2
3. Block 6
4. Block 4

5-12. The stamps on registered mail should be canceled with what equipment?

1. The all-purpose dating stamp
2. The postmarking stamp
3. The oval canceller
4. The canceling machine

5-13. Registered mail letters are postmarked on the back at least how many times?

1. One
2. Two
3. Three
4. Four

5-14. To recall a registered article after dispatch, what information should the mailer furnish the Postal Clerk?

1. The names and addresses of the mailer and addressee and the date mailed
2. The names and addresses of the mailer and addressee, the registration number, and the date mailed
3. The date mailed, the registration number, and the fee and postage charge
4. The names and addresses of the mailer and addressee, the date mailed, and the value of the article

- 5-15. If a registered letter with a return receipt is recalled by the mailer before delivery, which, if any, of the following refunds is/are allowed?
1. The return receipt fee only
  2. The registration fee only
  3. The return receipt and registration fee
  4. None of the above
- 5-16. What is the highest level of classified material authorized shipment by registered mail if any?
1. Secret
  2. Top Secret
  3. Confidential
  4. None of the above
- 5-17. Registered mail can only be transported from overseas activities on which of the following types of air carriers?
1. Scheduled U.S. commercial passenger nonstop flights
  2. All-cargo aircraft
  3. AMC aircraft
  4. All of the above
- 5-18. When receiving registered mail by Navy military aircraft, you should be at the airport what minimum amount of time before the departure of the aircraft?
1. 1 hour
  2. 2 hours
  3. 3 hours
  4. 4 hours
- 5-19. Which of the following types of forms is/are used to receipt for registered mail?
1. PS Form 3854 only
  2. PS Form 3877 only
  3. PS Form 3854 and PS Form 3877
  4. PS Form 3813P
- 5-20. Volume mailers assign and account for registered articles by using what PS form?
1. PS Form 3806
  2. PS Form 3833
  3. PS Form 3854
  4. PS Form 3877
- 5-21. In the event the mailer has made a mistake in preparing PS Form 3877, a registry clerk should take what corrective procedure?
1. Change the incorrect registration number by writing over it only
  2. Draw a line through the incorrect number and rewrite the correct number only
  3. Draw a line through the incorrect number, initial the change, and make the correct entry
  4. Change the incorrect registration number by writing over it in the presence of the mailer
- 5-22. Official mail should be separated from personal mail in the processing of outgoing registered mail when what situation occurs, if ever?
1. The volume of personal mail warrants this procedure
  2. The standpoint scheme dictates this type of processing
  3. The use of FMC transportation requires this procedure
  4. Never
- 5-23. Concerning the mailbag equipment used to dispatch outgoing registered mail, which of the following statements is correct?
1. Any hole or tear in the mailbag renders the bag unusable
  2. A mailbag with a hole smaller than a 50-cent coin may be used
  3. A mailbag with a tear less than 6 inches long may be used
  4. A pouch with a worn or defective strap may be used

5-24. When preparing a registered mail pouch for dispatched, a military post office should use what PS form as an inside bill?

1. PS Form 3851
2. PS Form 3852
3. PS Form 3853
4. PS Form 3854

5-25. When a registry manifold bill is completed for the dispatch of registered mail, which of the following procedures is NOT correct?

1. The bill should be prepared by using a lead pencil
2. The bill should be prepared by using a ball-point pen
3. If an error is made during the preparation of the bill, draw a single line through the incorrect entry and initial the change
4. The bill should be completed in duplicate for a numbered seal pouch

5-26. What letter, if any, is used to indicate the last page of a dispatch that requires more than one registry manifold bill?

1. X
2. L
3. O
4. None

5-27. A numbered seal registered pouch that contains letter bundles should have the manifold bill enclosed in what manner?

1. Under the top piece of the bundle
2. Under the top piece of each bundle
3. Either 1 or 2 above, depending upon whether or not there is more than one bundle enclosed
4. Placed in a P-9 envelope

5-28. A numbered seal registered pouch should be sealed by threading the small plain end of the seal through the bottom of the staple toward and through two grommets of the pouch and then bent back and threaded into the ball of the seal. The seal number should appear in what position on the seal when the pouch is sealed?

1. The outside
2. The inside
3. Either 1 or 2 above, depending upon the position of the number when the seal was threaded through the staple.
4. Part on the inside and part on the outside

- |    |                          |
|----|--------------------------|
| A. | First line on the front  |
| B. | Second line on the front |
| C. | Third line on the front  |
| D. | Reverse side strip label |

IN QUESTIONS 5-29 THROUGH 5-33, YOU ARE PREPARING A STRIP LABEL FOR A NUMBERED SEAL POUCH. FROM THE LIST ABOVE, SELECT THE POSITION ON THE STRIP LABEL THAT CONTAINS THE INFORMATION LISTED IN THE QUESTION. EACH RESPONSE IS USED AT LEAST ONCE.

5-29. Indicates the destination of the mail pouch.

1. A
2. B
3. C
4. D

5-30. The endorsement REGISTERED.

1. A
2. B
3. C
4. D

- 5-31. The office of origin.
1. A
  2. B
  3. C
  4. D
- 5-32. Your initials and the postmark of your post office.
1. A
  2. B
  3. C
  4. D
- 5-33. The weight of the pouch listed in kilograms
1. A
  2. B
  3. C
  4. D
- 5-34. What devices are used on registered mail pouches or outside pieces to provide information to the air carrier on the method of handling and routing the articles?
1. Airport-coded tags
  2. Airport-coded labels
  3. Either 1 or 2 above, depending upon whether or not the dispatch is an outside piece or enclosed in a pouch
  4. USPS P-9, registry Pouch Bill Envelopes
- 5-35. When completing an outside bill, the PS Form 3854 should be completed in how many copies?
1. One
  2. Two
  3. Three
  4. Four
- 5-36. When preparing an outside bill you should always have what letter preceding the seal number of a registered sealed pouch on the outside bill documentation?
1. J
  2. O
  3. R
  4. S
- 5-37. The original and third copy of a completed PS Form 3854, Outside Bill, for a registered dispatch are disposed of in what manner?
1. They are enclosed along with a pre-addressed return envelope in a EP-9 envelope and attached to the outside of the last registry pouch
  2. They are enclosed along with a pre-addressed return envelope in a EP-11 envelope and attached to the last outside piece in the dispatch
  3. Either 1 or 2 above, depending upon whether or not there are any pouches in the dispatch
  4. They are forwarded separately by USPS indicia regular mail to the destination office of the dispatch
- 5-38. When dispatching registered mail directly to another MPO, how many copies of PS Form 3854 should be prepared?
1. One
  2. Two
  3. Three
  4. Four

5-39. You have received a numbered seal pouch containing registered mail. You check the seal number against the accompanying outside documentation to verify what factor?

1. The seal number is the same as listed on the accompanying outside documentation
2. The registered number listed on the outside documentation has the letter S preceding the number
3. The seal number on the pouch has not been tampered with
4. The registered number listed on the outside documentation has the letter O preceding the number

5-40. In the event a registered dispatch is received at an MPO without the accompanying documentation, what accounting procedures should be taken?

1. Prepare a substitute PS Form 3854 with the endorsement  
ORIGINAL—DUPLICATE NOT RECEIVED
2. Prepare a substitute PS Form 3854 with the endorsement  
DUPLICATE—ORIGINAL NOT RECEIVED
3. Prepare a substitute PS Form 3877 with the endorsement  
ORIGINAL—DUPLICATE NOT RECEIVED
4. Prepare a substitute PS Form 3877 with the endorsement  
DUPLICATE—ORIGINAL NOT RECEIVED

5-41. Military postal activities receiving tracer action on registered mail from a dispatching activity should immediately determine if the registered article was received. If received, which of the following procedures should be followed?

1. Immediately contact the dispatching activity by phone, E-mail, or naval message
2. Sign and return the duplicate form and return it to the dispatching activity
3. Both 1 and 2 above
4. Disregard the tracer action and inform no one except your postal officer

5-42. When registered mail is received at sea and circumstances prevent the immediate return of a receipt, which, if any, of the following procedures should the receiving ship follow to acknowledge receipt?

1. Send a message to the dispatching ship
2. As soon as possible forward the paper receipt to the dispatching activity
3. Both 1 and 2 above
4. Receipts are not necessary when dispatching registered mail at sea

5-43. Registered mail that is being transferred at sea should have flotation gear attached to the container to prevent sinking in case of loss.

1. True
2. False

- 5-44. The reporting procedure for damaged registered mail depends upon which of the following factors?
1. Whether or not the damaged registered article is personal or official
  2. If depredation or compromise is suspected
  3. Both 1 and 2 above
  4. The source of receipt
- 5-45. The accepting post office should be informed of noted irregularities by using what PS form?
1. PS Form 565
  2. PS Form 1510
  3. PS Form 3826
  4. PS Form 3854
- 5-46. When should you and the witness as receiving clerks sign the inside manifold bill of registered articles?
1. After verifying the seal number of the pouch against the seal number listed on the inside bill
  2. After checking the registered numbers of the enclosed pieces against those listed on the inside bill
  3. After entering the number of articles received
  4. After all the above have been completed
- 5-47. When registered articles received are not listed on the inside bill, which of the following procedures should be followed?
1. Enter the received article number on the bill and coupon with a note of explanation
  2. Immediately contact the dispatching activity by phone, E-mail, or naval message
  3. Return the coupon portion of the bill to the dispatching activity
  4. All of the above
- 5-48. You always prepare a bill and send a duplicate copy to the dispatching office for which of the following situations involving incoming registered mail?
1. A pouch of registered mail contains an improperly completed inside bill
  2. An article listed on the inside bill is not in the pouch
  3. A pouch of registered mail contains no inside bill
  4. All of the above
- 5-49. Official registered mail is receipted for by the mail orderly on what PS form?
1. PS Form 3849
  2. PS Form 3854
  3. PS Form 3877
  4. PS Form 3883
- 5-50. The bill numbers for PS Form 3883 are numbered in sequence starting with number 1 at the beginning of what calendar day?
1. 1 January
  2. 1 March
  3. 1 July
  4. 1 October
- 5-51. What document is used to notify customers that registered personal mail is being held for their pickup?
1. PS Form 3854
  2. PS Form 3849
  3. PS Form 3877
  4. PS Form 3883
- 5-52. When the addressee is unable to receipt for registered mail, the mail may be delivered in which of the following manners?
1. Receipted for by an authorized agent
  2. Receipted for by the addressee's division mail orderly
  3. Receipted for by a MPC
  4. All the above

5-53. All damaged personal registered mail should be rewrapped before delivery to the addressee. How should these articles be endorsed?

1. Endorse the rewrapped article RECEIVED IN DAMAGED CONDITION only
2. Endorse the rewrapped article RECEIVED IN DAMAGED CONDITION and initial and date the endorsement
3. Endorse the rewrapped article DAMAGED IN HANDLING IN THE USPS only
4. Endorse the rewrapped article DAMAGED IN HANDLING IN THE USPS and Initials

5-54. Registered mail that is received for an individual for whom there is no indication of a due-in date, but there is reason to believe the individual is due to arrive, may be held what maximum number of days?

1. 15
2. 60
3. 30
4. 45

5-55. When a registered letter is forwarded to an individual who no longer is assigned to your activity, which of the following steps should NOT be performed?

1. Backstamp the letter once
2. Draw a single diagonal line through the incorrect portions of the old address
3. Copy the new address on the face of the letter
4. Dispatch the letter under a new registration number assigned from your post office

5-56. Which of the DD forms listed below should your MPO use to balance the incoming and outgoing registered mail?

1. DD Form 2257
2. DD Form 2260
3. DD Form 2261
4. DD Form 2265

5-57. Which of the following determines when an MPO prepares the registered mail balance sheet?

1. Size of the MPO
2. Hours of operation
3. Both 1 and 2 above
4. Number of registered mail transactions

5-58. The transfer of accountability between registry clerks, upon change of custody of registered items, is accomplished by using what form?

1. DD Form 2261
2. PS Form 3854
3. Either 1 or 2 above, depending upon whether the change in custody is temporary or a permanent transfer
4. PS Form 3877

# ASSIGNMENT 6

Textbook Assignment: "Postal Finance," chapter 8, pages 8-1 through 8-52.

---

6-1. Postage stamps are affixed to articles to indicate which of the following services has been prepaid?

1. The handling charges
2. The transportation charge
3. The delivering charge
4. Each of the above

6-2. All Uncanceled United States postage stamps may be used for postage if they were printed in or after what year?

1. 1860
2. 1890
3. 1900
4. 1910

6-3. Materials presented for mailing that bears imitations of postage stamps should not be accepted for mailing.

1. True
2. False

6-4. Adhesive postage stamps are available in how many different forms?

1. One
2. Two
3. Three
4. Four

6-5. Which of the following forms of stamp issue consists of only 50 stamps?

1. A sheet of commemorative stamps
2. A coil of airmail stamps
3. A sheet of postage-due stamps
4. A coil of ordinary postage stamps

6-6. Stamp coils should be stocked in your Navy post office for which of the following purposes?

1. For those customers who prefer coils
2. For your stamp vending machines
3. For use as precanceled stamps
4. Each of the above

- |   |
|---|
| <p>A. Regular stamps<br/>B. Commemorative stamps<br/>C. Memorial stamps<br/>D. Special stamps</p> |
|---|

IN ANSWERING QUESTIONS 6-7 THROUGH 6-10, SELECT FROM THE ABOVE FIGURE THE TYPE OF SPECIAL PURPOSE STAMPS DESCRIBED AS THE QUESTION.

6-7. Stamps issued in observance of historical events.

1. A
2. B
3. C
4. D



- 6-8. Stamps issued only for the purpose for which they are designed.
1. A
  2. B
  3. C
  4. D
- 6-9. Stamps issued only for a special occasion.
1. A
  2. B
  3. C
  4. D
- 6-10. Stamps issued to honor U.S. presidents.
1. A
  2. B
  3. C
  4. D
- 6-11. Which of the following items are classified as postal stationery?
1. Blank money order forms
  2. Postal cards only
  3. Stamped envelopes only
  4. Postal cards and stamped envelopes
- 6-12. A member of your activity is corresponding with a friend in England and wishes to furnish the friend with sufficient funds to answer via airmail. What should you instruct the member to do?
1. Enclose international reply coupons in the letter to the friend
  2. Send the friend an unused aérogramme
  3. Enclose an airmail-stamped envelope in the letter to the friend
  4. Supply the friend with unused U.S. airmail postage stamps
- 6-13. Where should you keep the unsold stamps during the “open for business” hours?
1. On a shelf behind the counter
  2. On the counter
  3. With the stamped envelopes
  4. In the cash drawer
- 6-14. At the end of the working day, all funds and stamped items should be protected by locking them in the
1. post office
  2. safe
  3. stamp drawer
  4. stamp cabinet
- 6-15. When you arrange sheets of stamps, you should provide adequate protection against which of the following adverse actions?
1. Buckling
  2. Sticking together
  3. Curling
  4. All of the above
- 6-16. The combination to the safe in which funds and postal stock are stored should be sealed in what type of envelope?
1. In a plain white USPS envelope
  2. In PS Form 3977, Duplicate Key Envelope
  3. In DD Form 3967, Triplicate Key Envelope
  4. In a dark-colored official envelope

- 6-17. The combinations to safes used to store postal funds and stamp stock should be changed at which of the following times?
1. Upon initially receiving the safe
  2. Whenever there is a compromise of the combination
  3. Whenever an individual who has had custody of the combination is transferred or relieved of credit
  4. All of the above
- 6-18. What procedure is recommended to avoid disagreements about the amount of money given you in a stamp transaction?
1. Ask the patron to pay the exact amount of the purchase
  2. Keep the money received in view until the transaction is completed
  3. Put the money received in a special compartment until the patron has accepted the change
  4. Accept payment only after handing over the stamps
- 6-19. Military postal clerks are not permitted to affix stamps to articles for which postage has just been sold. The mailer of the article must affix the stamps.
1. True
  2. False
- 6-20. The fixed credit of a military post office includes which of the following items?
1. Postal stationery, money order forms, and postage stamps
  2. Funds from the sale of money orders and stamps only
  3. Funds from the sale of postal stationery and stamps only
  4. Funds from the sale of money orders, stamps, and postal stationery
- 6-21. When a Navy post office is established, the total amount of fixed credit desired should be determined in what manner?
1. By allowing only \$10 per person served
  2. By allowing only \$10 per person served with at least a \$2,000 minimum limit
  3. By allowing only \$25 per person served
  4. By allowing only \$25 per person served with at least a \$5,000 minimum limit
- 6-22. What amount of fixed credit is normally carried by an aircraft carrier?
1. \$100,000
  2. \$50,250
  3. \$30,000
  4. \$10,750
- 6-23. The invoice that accompanies the shipment of the original stock to a newly established Navy post office is retained by what official?
1. The commanding officer
  2. The disbursing officer
  3. The postal officer
  4. The custodian of postal effects
- 6-24. To show the status of the postal effects before commencing postal operations, an audit of postal accounts should be held and submitted on the authorized date of establishment.
1. True
  2. False

- 6-25. The amount of fixed credit normally held by the custodian of postal effects may be either increased or decreased when deemed necessary by what individual?
1. The postal officer
  2. The commanding officer
  3. The accountable postmaster
  4. The Director, Military Postal Service
- 6-26. One of your duties as COPE is the sale of stamps to customers. Your assistant handles money orders and claims. In making stamp sales during your absence, what procedure should your assistant follow?
1. Sell stamps from the stamp stock in your stamp drawer
  2. Sell stamps taken directly from the stock in the post office safe
  3. Sell stamps borrowed from the reserve custodian
  4. Sell stamps from that portion of the fixed credit issued to him or her
- 6-27. A window clerk should exchange cash for stamps from the COPE at least how often?
1. When the accumulated cash (excluding a \$50 cash fund) exceeds 10% of the extended credit
  2. When the accumulated cash (excluding a \$50 change fund) exceeds 25% of the extended credit
  3. Weekly
  4. Either 2 or 3 above, whichever occurs first
- 6-28. The total fixed credit of your activity is \$5,000. Replenishment of the fixed credit is required when the amount of cash on hand reaches what specific amount?
1. \$1,250
  2. \$1,000
  3. \$750
  4. \$700
- 6-29. You are ordering stamp stock to replenish the total fixed credit. What should be your first step?
1. Estimate the amount of time required to receive the stock
  2. Consider any approaching holiday seasons
  3. Determine how much cash is to be exchanged for stamp stock
  4. Consider your facilities for protecting stamp stock
- 6-30. Stamp requisitions are prepared and submitted on what form?
1. PS Form 17
  2. PS Form 3295
  3. PS Form 3365
  4. PS Form 3367
- 6-31. Stamp requisitions are numbered in sequence with number (1) on the first day of the fiscal year that begins on what calendar date?
1. 1 January
  2. 1 July
  3. 1 October
  4. 1 December
- 6-32. How many copies of PS Form 17 are sent with the check to the accountable postmaster?
1. Original and one
  2. Original and two
  3. Original and three
  4. Original and four
- 6-33. Treasury checks should be made payable to what official?
1. The Chief of Naval Operations
  2. The Postmaster, New York
  3. The Accountable Postmaster
  4. The Executive Director, MPSA

- 6-34. You should destroy the fourth copy of the stamp requisition at what point in time?
1. Retain in files 2 years; then destroy
  2. After you and the custodian have verified the stamp stock shipment and completed the entries on the duplicate stamp requisition
  3. Upon receipt of the stamp stock
  4. Never
- 6-35. After verifying a stamp stock shipment and completing your copy of the requisition, what action should you take?
1. Determine the number and denominations to be issued to your assistants
  2. Record the receipt of the stamp stock on PS Form 3295
  3. Store the stamp stock in your safe
  4. Divide the stamp stock into equal Lots for yourself, the reserve custodian, and your assistants
- 6-36. If you and the custodian discover that a shipment of stamp stock is short, the facts should be reported immediately to what officials or office?
1. The commanding officer and the Chief of Naval Operations
  2. The Chief of Naval Operations and the accountable postmaster
  3. The accountable postmaster and the disbursing officer
  4. The commanding officer, the postal officer
- 6-37. The postage meter machine consists of what basic part(s)?
1. The postage meter only
  2. The mailing machine only
  3. The postage meter and meter base
  4. The postage meter, mailing machine, and meter key
- 6-38. A postage meter tape cannot be printed for more than what maximum amount?
1. \$9.99
  2. \$10.99
  3. \$49.99
  4. \$99.99
- 6-39. The ascending register on the postage meter head will always show the amount of postage in dollars and cents remaining on the meter.
1. True
  2. False
- 6-40. The recording of daily meter register readings is shown on what form?
1. PS Form 3083
  2. PS Form 3602-PO
  3. PS Form 3603
  4. PS Form 3610
- 6-41. PS Form 3602-POs are issued in pads of what specific number?
1. 50 forms in duplicate
  2. 100 forms in duplicate
  3. 50 forms in triplicate
  4. 100 forms in triplicate
- 6-42. When a postage meter head becomes defective, no attempt to repair the meter is authorized.
1. True
  2. False
- 6-43. A money order set consists of what total number of parts?
1. One
  2. Two
  3. Three
  4. Four

- 6-44. The serial number assigned a money order consists of what total number of digits?
1. 5
  2. 8
  3. 11
  4. 15
- 6-45. The customer's receipt for a money order is completed by the issuing money order clerk.
1. True
  2. False
- 6-46. At what point in time, if at all, should you advise the customer to complete his money order receipt?
1. While you are preparing the money order
  2. Immediately after the customer purchases the money order
  3. Immediately before the customer needs to use the money order
  4. Not at all, it's your responsibility as money order clerk
- 6-47. In a shipboard MPO, the supply of blank money order forms should be sufficient to last what minimum period of time?
1. 5 months
  2. 2 months
  3. 3 months
  4. 4 months
- 6-48. What is the maximum supply level of blank money order forms authorized to be held by a shipboard MPO?
1. 3-month supply
  2. 5-month supply
  3. 10-month supply
  4. 12-month supply
- 6-49. A shore activity MPO should maintain blank money order forms to last what minimum period of time?
1. 5 months
  2. 2 months
  3. 3 months
  4. 4 months
- 6-50. Money order requisitions should be submitted what minimum number of days before the forms are needed?
1. 15
  2. 25
  3. 30
  4. 45
- 6-51. Before ordering blank money order forms for a shipboard MPO, which of the following factors should you consider?
1. Ship's operating schedule
  2. Ship plans an upcoming deployment
  3. Ship plans on an increase of personnel during upcoming deployment
  4. All of the above
- 6-52. Blank money order forms are requisitioned on what PS form?
1. PS Form 6019-MPO
  2. PS Form 17
  3. PS Form 6401
  4. PS Form 6990
- 6-53. An emergency requisition for blank money order forms should be submitted in message form to what official or organization?
1. The appropriate (FLTCINC) postal officer info copy to MPSA
  2. The Money Order Division, St. Louis, MO
  3. The Military Postal Service Agency
  4. The appropriate joint military postal activity

- 6-54. A record of blank money forms assigned to a military post office is made on what form?
1. DD Form 834
  2. DD Form 885
  3. PS Form 1908
  4. PS Form 6019
- 6-55. The custodian of blank money order forms should issue blank forms to the money order clerk in blocks of what minimum amount?
1. 50
  2. 100
  3. 150
  4. 200
- 6-56. Which of the following areas on a blank money order form should NOT be handled?
1. The upper third
  2. The top half
  3. The bottom third
  4. The bottom half
- 6-57. In what location should a money order imprinter be stowed when not in use?
1. COPE's safe
  2. Reserve custodian's safe
  3. Postal officer's safe
  4. Out of reach of customers
- 6-58. During the process of issuing a money order, at what point should you snap out the carbons from the money order set?
1. Before inserting the blank money order set into the money order imprinter
  2. Immediately upon the removal of the completed money order set from the money order imprinter
  3. After the completed money order set is removed from the money order imprinter and checked for accuracy
  4. After the amount for which the money order is written, plus the fee, is collected
- 6-59. What minor alternations, if any, would be acceptable on a newly printed money order?
1. If the asterisk was printed in the cents position rather than a zero
  2. If the office number plate was removed
  3. If you forgot to set the correct date before issuing the money order set
  4. None
- 6-60. For a money order that is being treated as spoiled, it is permissible to stamp or write SPOILED on the upper one-third part.
1. True
  2. False
- 6-61. International money orders may not be cashed at a military post offices.
1. True
  2. False

- 6-62. Which of the following types of identification cards is/are acceptable for cashing a money order at a military post office?
1. An official government identification card
  2. A U.S. passport
  3. Both 1 and 2 above
  4. A social security card
- 6-63. A representative cashing a money order for an organization must endorse the money order in what manner?
1. Signature only
  2. Organizational title only
  3. Signature and organizational title
  4. By marking X in the presence of the COPE
- 6-64. When cashing a money order, the money order clerk affixes which of the following endorsements on the reverse side of the money order?
1. The identification card number
  2. Initials
  3. The all-purpose dating stamp impression
  4. Both 2 and 3
- 6-65. How often are money order reports required to be prepared and submitted?
1. Daily
  2. Weekly
  3. Monthly
  4. Bimonthly
- 6-66. The report of money order business conducted is submitted on what PS form?
1. PS Form 6019-MPO
  2. PS Form 6055-A
  3. PS Form 6401
  4. PS Form 6701
- 6-67. The money order report should be prepared as an original and two copies.
1. True
  2. False
- 6-68. The money order adding machine tape should be prepared in what total number of originals?
1. One
  2. Two
  3. Three
  4. Four
- 6-69. The money order report is submitted by what type of mail?
1. USPS Official Registered or Express mail
  2. USPS Official First-Class
  3. USPS Official Certified
  4. SPS Official Insured

# ASSIGNMENT 7

Textbook Assignment: "Mail Handling and Transportation," chapter 9, pages 9-1 through 9-49.

---

- |  |
|--|
| <ul style="list-style-type: none"><li>A. Unit postal officer</li><li>B. Mail clerk</li><li>C. Mail orderly</li><li>D. Administrative officer</li></ul> |
|--|

IN ANSWERING QUESTIONS 7-1 THROUGH 7-3, REFER TO THE ABOVE FIGURE. SELECT THE PERSON WHOSE DUTY IS DEFINED IN THE QUESTION.

- 7-1. Maintain an up-to-date directory on personnel being served.
- 7-2. Supervises the operation of a unit mailroom.
- 7-3. Delivers personal mail to addressees only.
- 7-4. Mail orderly is an individual designated by proper authority to do mail duties in association with the operation of a unit mailroom.
- 1. True
  - 2. False
- 7-5. Mail clerk is an individual designated to perform mail-handling duties.
- 1. True
  - 2. False
- 7-6. How must combinations and keys to the post office be safe guarded?
- 1. Sealed in envelope 3966 and sign over to designated representative
  - 2. Sealed in envelope 3977 and sign over to designated representative
  - 3. Maintained by your unit mail orderly
  - 4. Maintained by your unit mail orderly
- 7-7. Which of the following individuals would normally be allowed access to a unit mailroom while the unit postal clerk is conducting official business?
- 1. SN Jones who is visiting the unit postal clerk
  - 2. Mr. Smith who is selling mutual funds
  - 3. The unit postal clerk's brother-in-law who is in the Navy, visiting, while on authorized leave
  - 4. Working party
- 7-8. What type of mail must be locked when responsible individual are not physically present?
- 1. First class mail
  - 2. Magazines
  - 3. Newspapers
  - 4. Express mail



- 7-9. Security of U.S. mail by unit mailrooms includes which of the following actions?
1. The mail-handling areas must be locked when the responsible individual is/are physically present
  2. Mail in the custody of mail clerks or mail orderlies must not be subject to delay, interception, or seizure
  3. Mail must be delivered only to the addressee or an agent designated in writing by the addressee
  4. All of the above
- 7-10. If the situation requires U.S. mail to be transported in a privately owned vehicle, permission to do so must be obtained from what official?
1. The commanding officer
  2. The unit postal officer
  3. The executive officer
  4. The postmaster of the serving postal activity
- 7-11. The most common method of delivering mail to addressees by naval activities is the use of what type of system?
1. General delivery
  2. Mail orderlies
  3. Mail receptacles
  4. Mail clerks
- 7-12. Damaged articles received in closed bags at unit mailrooms should have what endorsement placed on them?
1. **DAMAGED IN ORDINARY MAIL AT (location)**
  2. **DAMAGED IN HANDLING IN THE POSTAL SERVICE**
  3. **DAMAGED IN HANDLING IN THE MILITARY POSTAL SERVICE**
  4. **DAMAGED IN HANDLING**
- 7-13. Mail addressed in care of another person or addressed to more than one addressee must be returned to the sender.
1. True
  2. False
- 7-14. Official registered mail received in the ordinary mail at unit mailrooms should be disposed of in which of the following manners?
1. Prepare PS Form 3883 and deliver the registered article to the appropriate mail orderly
  2. Prepare a modified PS Form 3877 in duplicate for the return of the registered article
  3. Return the registered article to the registry section of the serving post office
  4. Both 2 and 3 above
- 7-15. Which of the following statements is NOT correct pertaining to the delivery of mail at a unit mailroom?
1. Postage-due mail will be collected before delivery to the addressee
  2. Postage-due and special delivery mail will be delivered as regular mail
  3. C.O.D. mail will be returned to the serving post office for processing
  4. Postage due will not be collected
- 7-16. If the addressee refuses an article and declines to sign and date the refused article, which of the following procedures should the delivery mail clerk follow?
1. Endorse the article **REFUSED BY ADDRESSEE**
  2. Date and sign the article
  3. Both 1 and 2 above
  4. Endorse the article **REFUSED** and dispose of as waste

- 7-17. Stamps found loose in the mail at a unit mailroom will be disposed of in what manner?
1. Forwarded to serving post office
  2. Destroyed
  3. Turned over to the unit postal officer
  4. Returned to MPSA with a letter of explanation
- 7-18. Before receipting for official registered mail, the unit mail clerk should follow which of the following procedures?
1. Ensure all articles being receipted for are listed on the form
  2. Ensure all articles being receipted for are in good condition and have not been tampered with
  3. Ensure that any repaired or rewrapped articles have the endorsement **DAMAGED IN HANDLING IN THE POSTAL SERVICE** placed on the wrapper or container
  4. All of the above
- 7-19. A departmental mail orderly receipts for official registered mail from a unit mail room. Which of the following PS forms is/are used for the proper receipting procedure?
1. PS Form 3812
  2. PS Form 3850
  3. PS Form 3883
  4. Both 2 and 3 above
- 7-20. A unit mail clerk returning undeliverable registered mail to the registry section of the serving post office uses what modified PS form for a record of disposition?
1. PS Form 3849-A
  2. PS Form 3850
  3. PS Form 3854
  4. PS Form 3877
- 7-21. When should you send out a second 3849 notice to the addressee to pickup his accountable mail from the post office?
1. 5 days
  2. 10 days
  3. 15 days
  4. 20 days
- 7-22. If requested by the mailer, to which of the following types of mail can restricted delivery services apply?
1. Numbered insured
  2. Certified
  3. Both 1 and 2 above
  4. Unnumbered insured
- 7-23. An incoming article that has restricted delivery services requested can be identified by what endorsement(s) on the article?
1. RESTRICTED DELIVERY only
  2. PERSONAL only
  3. RESTRICTED DELIVERY and PERSONAL
  4. DELIVER TO ADDRESSEE ONLY
- 7-24. Addressees can authorize the delivery of mail, including restricted delivery mail that is addressed to them, by completing and filling what PS form at the serving military post office?
1. PS Form 3801
  2. PS Form 3811
  3. PS Form 3849-A
  4. PS Form 3849-B
- 7-25. MODIS is a system used to measure transit times.
1. True
  2. False

- 7-26. MODIS scanning is required each time mail is received, whether the mail is for your command or for mail you have received for further transfer.
1. True
  2. False
- 7-27. What form authorized a mail orderly to pick up mail?
1. PS Form 3849
  2. PS Form 3883
  3. DD Form 285
  4. DD Form 385
- 7-28. All damaged mail that requires rewrapping or resealing should be endorsed DAMAGED IN HANDLING IN THE POSTAL SERVICE.
1. True
  2. False
- 7-29. What disposition instruction should you make for obvious value items found loose in the mail?
1. Should be given to the chaplain
  2. Should be destroyed
  3. Return to nearest FMC
  4. Send registered mail to the appropriate accountable postmaster
- 7-30. What form is used to report a discrepancy in the handling of mail?
1. DD Form 2276
  2. DD Form 2275
  3. DD Form 2274
  4. DD Form 2273
- 7-31. Incoming items prepaid for special delivery should bear a label printed in what color?
1. Blue
  2. Black
  3. Green
  4. Red
- 7-32. Which endorsement is not an insurance endorsement according to the language of the country of origin?
1. INSURED
  2. ASEGURADO or VALOR DECLARADO
  3. AVIS DE RECEPCION
  4. VD
- 7-33. What is the PS form number for an International Return Receipt?
1. PS Form 2685
  2. PS Form 2865
  3. PS Form 2568
  4. PS Form 2856
- 7-34. Mail log must be maintained on file for what period of time?
1. 3 months
  2. 6 months
  3. 9 months
  4. 12 months
- 7-35. What is the most important step in the mail delivery cycle?
1. Processing and makeup
  2. Delivery
  3. Accountability
  4. Registering

- 7-36. Who usually supplies collection boxes for ships?
1. MPSA
  2. USPS
  3. JMPA
  4. COMNAVSEASYSCOM
- 7-37. When requisitioning three position tumbler locks you should requisition them in what quantities?
1. 6 or 10
  2. 6 or 12
  3. 8 or 10
  4. 8 or 12
- 7-38. Mail collections should be displayed on all collection boxes using what USPS item?
1. D1175
  2. D1275
  3. D1300
  4. D1500
- 7-39. Mail with insufficient postage should be returned to sender.
1. True
  2. False
- 7-40. Mail without postage should be returned to sender.
1. True
  2. False
- 7-41. When is free mail authorized?
1. When station over seas
  2. When serving in a combat area
  3. When mailing to a ship station in Guam
  4. When authorized by the commanding officer
- 7-42. What type of mail may be sent free?
1. Registered mail
  2. Certified mail
  3. Postcards
  4. Insured mail
- 7-43. When can IDS mail be sent to the United States?
1. When the addressee has moved back to CONUS
  2. While station in GUAM
  3. When sent to dead mail branch SFO
  4. Never
- 7-44. How many days a week should overseas and aboard deployed units should schedule pickups from collections boxes?
1. 4 days
  2. 5 days
  3. 6 days
  4. 7 days
- 7-45. What is the maximum limit on philatelic covers per collector?
1. 3
  2. 4
  3. 5
  4. 10
- 7-46. A full sized managed mail tray hold an average of how many letters?
1. 300
  2. 600
  3. 900
  4. 1200

- 7-47. Mail trays are intended to be used how many times before a tray should be discarded?
1. 1
  2. 10
  3. 20
  4. 30
- 7-48. What is the maximum weight of mail you can place in canvas bags?
1. 50 lbs
  2. 70 lbs
  3. 90 lbs
  4. 100lbs
- 7-49. Slide labels should be ordered of what form?
1. PS Form 1578-B
  2. PS Form 1578-A
  3. PS Form 1000
  4. PS Form 900
- 7-50. What official or agency pays for transportation charges for FPO mail from JFK, New York, NY, to Naval Station, ROTA, Spain?
1. USPS
  2. Department of the Army
  3. Department of the Navy
  4. Joint military postal activity
- 7-51. What official or agency pays for transportation charges for FPO mail from JFK, New York, NY, to Naval Station, Norfolk, VA?
1. USPS
  2. Department of the Army
  3. Department of the Navy
  4. Joint Military Postal
- 7-52. The type of transportation used for the transport of military mail by Navy post offices depends on which of the following factors?
1. The location of the unit
  2. The method of transportation available
  3. The lead time required to ensure delivery
  4. Each of the above
- 7-53. The use of foreign air carriers is limited to those routes where AMC and U.S. carriers do not operate.
1. True
  2. False
- 7-54. The use of Military Airlift Command carriers for the movement of military mail is limited to what factor?
1. U.S. commercial carrier service for the desired route is not available
  2. U.S. commercial carrier service for the desired route is not adequate
  3. Either 1 or 2 above, depending on the situation
  4. Military Airlift Command must only be used for intra-area mail transports
- 7-55. The use of Sea-Van containers for the transport of surface mail serves which of the following purposes?
1. Provides security for the mail
  2. Eliminates unnecessary handling of the mail
  3. Both 1 and 2 above
  4. Provides for a more accurate mail piece count

- 7-56. While military mail is transported, when, if ever, is a tin-band seal required in addition to the lock to secure the doors of a mail vehicle?
1. When the vehicle driver is a designated Postal Clerk and registered mail is not included in the dispatch
  2. When the vehicle driver is not a designated Postal Clerk and has access to the key or combination to the lock
  3. When the vehicle driver is a designated Postal Clerk and registered mail is included in the dispatch
  4. Never
- 7-57. Military mail that is transported on any domestic or foreign commercial air carriers should be documented on what form?
1. DD Form 1384
  2. PS Form 2900
  3. PS Form 2942-A
  4. OPNAV Form 5110/9
- 7-58. PS Form 2942-A is printed in set of how many sheets?
1. 5
  2. 7
  3. 10
  4. 13
- 7-59. What form number is TCMD?
1. DD 1384
  2. DD 1385
  3. OPNAV 5110/9
  4. OPNAV 5110/5
- 7-60. When mail is transported by opportune aircraft, the mail should be manifested on what form?
1. OPNAV Form 5110/9
  2. NAVEURGEN Form 2700/2A
  3. Either 1 or 2 above, depending upon the desires of the dispatching activity
  4. DD Form 1384
- 7-61. You must retain signed copies of manifests used to dispatch registered mail what number of years?
1. 1 year
  2. 2 years
  3. 3 years
  4. 4 years

# ASSIGNMENT 8

Textbook Assignment: "Claims and Inquiries," chapter 10, pages 10-1 through 10-23, and "Mail Directory Service," chapter 11, pages 11-1 through 11-26.

---

- 8-1. A complaint is an expression of dissatisfaction, discontent, disappointment, or resentment by a postal customer concerning any postal product, service, or postal personnel.
1. True
  2. False
- 8-2. At Navy post offices, the number of mail complaints could be greatly reduced if commanding officers would keep their customers informed of the type of mail service they can expect. This can be done by following which of the following procedures?
1. By the issuance of family-grams
  2. By holding predeployment briefings
  3. By keeping the customers informed of the expected mail services through plan of the day notices
  4. All of the above
- 8-3. Upon the completion of the PS Form 4314-C, Consumer Service Card, the postal customer should retain what copy?
1. Copy 1
  2. Copy 2
  3. Copy 3
  4. Copy 4
- 8-4. The Consumer Service Card file should be maintained in a central location and made up of what copy of PS Form 4314-C?
1. Copy 1
  2. Copy 2
  3. Copy 3
  4. Copy 4
- 8-5. To report complaints by the mailer of the loss of a domestic ordinary letter, you should prepare what PS form?
1. PS Form 565
  2. PS Form 673
  3. PS Form 1510
  4. PS Form 3812
- 8-6. Which of the following persons may initiate a PS Form 1510?
1. Mailer
  2. Addressee
  3. Both 1 and 2 above
  4. The postal officer at the mailing
- 8-7. In processing an inquiry for the alleged loss of a domestic ordinary letter, you refer to the charts exhibited in what publication?
1. The Domestic Mail Manual
  2. The Postal Operations Manual
  3. The Administration Service Manual
  4. The Department of Defense Postal Manual

- 8-8. Indemnity claims can be filed through USPS for which of the following types of mail?
1. A damaged article that was insured by the USPS
  2. A lost registered and Express mail article that was insured by the USPS
  3. Both 1 and 2 above
  4. An article that was commercially insured and entered into the USPS has ordinary mail
- 8-9. An indemnity claim may be filed immediately under which of the following circumstances?
1. Only if the claim is being filed for partial damage
  2. Only if the claim is being filed for complete damage
  3. If the claim is being filed for partial or complete damage
  4. If the claim is being filed for complete loss
- 8-10. Which of the following types of evidence must be provided when a postal claim is being filed?
1. The original mailing receipt
  2. The original wrapper showing the article was insured and the names and addresses of both the mailer and addressee
  3. Either 1 or 2 above, depending upon what is available
  4. A reproduced copy of the mailing receipt
- 8-11. Before a claim is filed for an insured lost article that was mailed by surface ocean transportation, the claimant should wait at least how many days from the date the article was mailed?
1. 75 days
  2. 180 days
  3. 30 days
  4. 45 days
- 8-12. Registered mail indemnity claims must be filed within what maximum period of time from the date the material was mailed?
1. 9 months
  2. 12 months
  3. 3 months
  4. 6 months
- 8-13. Articles with salvage value must be retained at the MPO what number of days before forwarding to the serving Mail Recovery Center?
1. 30
  2. 60
  3. 90
  4. 180
- 8-14. What form number is a receipt for article damage in the mail?
1. PS Form 1000
  2. PS Form 3811
  3. PS Form 3831
  4. PS Form 3841
- 8-15. International inquiry about a lost or damaged registered article should be processed on what form?
1. PS Form 542
  2. PS Form 3812
  3. PS Form 3862
  4. PS Form 3863



- 8-16. What PS form is used to file a claim for an Express Mail article?
1. PS Form 5690
  2. PS Form 2855
  3. PS Form 673
  4. PS Form 565
- 8-17. An application for refund of postage and fees collected for retail must be initiated by using what PS Form?
1. PS Form 3977
  2. PS Form 3887
  3. PS Form 3577
  4. PS Form 3533
- 8-18. Customer may submit PS Form 6401 at any time for a money order inquiry.
1. True
  2. False
- 8-19. The primary purpose of mail directory service is to expedite early disposition of mail that is undeliverable as addressed.
1. True
  2. False
- 8-20. Which of the following Navy commands must maintain a directory file?
1. One that does not have a military post office
  2. One that receives mail through a United States civil post office
  3. One that operates a military post office
  4. All of the above
- 8-21. At commands that have a military post office, who would normally maintain the mail directory?
1. Military postal clerks at that MPO
  2. Command mail orderlies of each department
  3. Postal officer
  4. Administrative officer
- 8-22. Under what agreement does DOD agree to provide directory service for undeliverable-as-addressed military mail and endorse each piece to show a forwarding address or reason for nondelivery?
1. Postal agreement between USPS and Department of Defense
  2. Postal agreement between USPS and Department of the Navy
  3. Festal agreement between USPS and Department of the Army
  4. Postal agreement between USPS and Department of the Air Force
- 8-23. What OPNAV form is used to help process directory mail?
1. OPNAV Form 5110/3
  2. OPNAV Form 5110/5
  3. OPNAV Form 5110/9
  4. OPNAV Form 5110/10
- 8-24. The permanent address of one of your patrons who transferred to a new duty station was not available at time of transfer. Pending the patron's arrival at the new duty station, where should you forward the patron's mail?
1. An intermediate activity
  2. A nonmilitary address
  3. The command directory service
  4. A receiving station

- 8-25. Certain service members who are transferred for discharge do not want their mail forwarded to a civilian address. What should the Postal Clerk do with such service members' mail when it has a return address?
1. Return the mail to sender
  2. Send the mail to Chief of Naval Operations (Postal Affairs Branch)
  3. Treat the mail as dead mail
  4. Send the mail in care of general delivery to the post office of the member's home of record
- 8-26. Seaman Foster has been honorably discharged from the Navy. After what minimum period of time should you destroy this individual's directory card?
1. Immediately
  2. 15 days
  3. 6 months
  4. 12 months
- 8-27. The directory file should be screened and all expired directory cards removed and destroyed during what time period?
1. The first workweek of each month
  2. The second workweek of each month
  3. The third workweek of each month
  4. The fourth workweek of each month
- 8-28. The information that is necessary to maintain a proper directory file system can be obtained from which of the following sources?
1. The command change of address cards
  2. Advance copies of an individual's orders
  3. Rosters of attached squadrons and/or detachments
  4. All of the above
- 8-29. The endorsement ADDRESS CORRECTION REQUESTED does not apply to military post offices or unit mailrooms.
1. True
  2. False
- 8-30. The indication that a letter has been given directory service is stamped on what part of the letter?
1. To the left of the address
  2. On the reverse side
  3. Over the postmark
  4. Below the postage stamps
- 8-31. Undeliverable mail for which there is indication that the individual is due to arrive should be held for what maximum period of time?
1. 15 days from the original date
  2. 15 days past the due-in date
  3. 30 days past the due-in date
  4. 45 days past the due-in date
- 8-32. Undeliverable mail for an individual for whom there is no indication of a due-date but you have reason to believe the individual is due to arrive. What maximum period of time, if any, from the original date of receipt should you hold the mail?
1. 15 days
  2. 60 days
  3. 30 days
  4. None since there is no indication of a due-date, mail should be returned to the sender

- 8-33. All undeliverable mail that is being held should be screened against the directory files at least how often?
1. Every day
  2. Each week
  3. Every 2 weeks
  4. Each month
- 8-34. Undeliverable registered mail for which the mailer has not specified a hold period should be held what maximum number of days from the date of original receipt?
1. 10 days
  2. 15 days
  3. 30 days
  4. 5 days
- 8-35. Which of the following PS forms should be used to notify a publisher that a change of address has occurred after transfer of a military member?
1. PS Form 17
  2. PS Form 2759
  3. PS Form 3579
  4. PS Form 6019
- 8-36. Magazines should be forwarded for sixty days to the publishers.
1. True
  2. False
- 8-37. To prevent sending duplicate notifications to publishers, you should follow what procedure?
1. Keeping a log on 3335
  2. Making an entry on OPNAV Form 5110/5 directory file
  3. Either 1 or 2 above, depending on local preference
  4. Making an entry on OPNAV Form 5110/3
- 8-38. Catalogs that are undeliverable should be placed in the post office lobby if your MPO is overseas.
1. True
  2. False
- 8-39. Which of the following statements is/are true pertaining to the proper disposition of undeliverable income tax booklets?
1. They should be released to the appropriate local office designated by the commanding officer
  2. Before releasing the booklets, all address labels should be removed and destroyed
  3. Postal bulletin notices pertaining to nonrelease of income tax booklets do not apply to a military post office
  4. All of the above
- 8-40. If voting and balloting material is undeliverable and a forwarding address is not known, the matter should be returned to the mailer.
1. True
  2. False
- 8-41. Which of the following publications serves as a ready resource for information concerning mail for military members confined for disciplinary reasons?
1. Department of Defense volume I
  2. Department of Defense volume II
  3. Domestic Mail
  4. Navy Corrections Manual, SECNAVINST 1640.9

- 8-42. What endorsement should be placed and/or action taken on an article received at an overseas MPO addressed to an individual not authorized MPO privileges?
1. Endorse the letter RETURN TO SENDER
  2. Destroy the article
  3. Endorse the letter NOT AUTHORIZED MPO PRIVILEGES, but go ahead and deliver the letter
  4. Endorse the letter ADDRESSEE NOT AUTHORIZED MPO PRIVILEGES and return the letter to sender
- 8-43. Mail that received directory service by unit mail clerks should be returned to the serving postal separately from uncanceled outgoing mail.
1. True
  2. False
- 8-44. What action should be taken when your MPO receives a perishable article with a required delivery date but cannot be forwarded to meet that RDD?
1. Dispose of the article as waste
  2. Give the article to the library
  3. Give the article to the postal officer
  4. Forward the article to the Mail Recovery Branch
- 8-45. Mail addressed for members due to arrive how many days past the anticipated arrival date?
1. 5
  2. 10
  3. 15
  4. 20
- 8-46. Mail addressed for members AWOL should be returned to sender after how many days?
1. 30
  2. 60
  3. 90
  4. 120
- 8-47. Accountable mail must be refused by the patron at the time of delivery, before receipting for the article.
1. True
  2. False
- 8-48. Postal clerk must write, "REFUSED" on the front the mail, the date the mail was refused, and sign his name.
1. True
  2. False
- 8-49. Which of the following endorsements should not be placed on casualty mail?
1. MISSING IN ACTION
  2. KILLED IN ACTION
  3. WOUNDED
  4. All of the
- 8-50. Directory mail service for a decommissioned ship is performed for what total period of time?
1. 30 days
  2. 60 days
  3. 90 days
  4. 120 days

# ASSIGNMENT 9

Textbook Assignment: "Postal Equipment and Supplies" chapter 12, pages 12-1 through 12-26, and "Official Mail" chapter 13, pages 13-1 through 13-18

---

- 9-1. What publication lists supply items available for issue to military post offices?
1. OPNAVINST 5112.6
  2. DOD Postal Supply Catalog
  3. DOD Postal Manual, volume I
  4. DOD Postal Manual, volume II
- 9-2. When unusual supply items are needed, the procurement of these supplies must be authorized by what official/activity?
1. FLTCINC and JMPA
  2. CNO
  3. Postal officer
  4. Commanding officer
- 9-3. Capital equipment is equipment that has a life expectancy under 1 year.
1. True
  2. False
- 9-4. What is the dollar amount that an item must cost to be considered as capital equipment?
1. \$1000
  2. \$2000
  3. \$3000
  4. \$4000
- 9-5. What PS Form is use to account for capital and sensitive equipment?
1. PS Form 1000
  2. PS Form 1496
  3. PS Form 1590
  4. PS Form 1598
- 9-6. The commanding officer or postal officer, as appropriate, will ensure that the custody and/or control of USPS accountable equipment is entrusted to which of the following individuals?
1. COPE
  2. MPO supervisor
  3. Chief in charge
  4. Postal Clerk first class
- 9-7. What PS Form is use to requisition capital and sensitive equipment?
1. PS Form 1590
  2. PS Form 1586
  3. PS Form 7381
  4. PS Form 8799
- 9-8. Which of the following individuals is responsible for the control and maintenance of USPS accountable items issued to a military post office by the accountable postmaster?
1. The commanding officer
  2. The custodian of postal effects
  3. The postal officer
  4. The designated supply
- 9-9. To operate efficiently, shore post offices should maintain (a) at least what level but (b) not more than what level of expendable supplies aboard?
1. (a) 5 months; (b) 7 months
  2. (a) 6 months; (b) 8 months
  3. (a) 3 months; (b) 5 months
  4. (a) 4 months; (b) 6 months

- 9-10. Issuing postal supplies are the responsibility of what individual?
1. COPE
  2. Postal officer
  3. Registered clerk
  4. Postal supply clerk
- 9-11. A requisition for expendable supplies should be completed on what PS form?
1. PS Form 7380
  2. PS Form 4686-A
  3. PS Form 1536
  4. PS Form 1567
- 9-12. Requisitions are numbered consecutively beginning with 1 on 1 October each year.
1. True
  2. False
- 9-13. Which of the following statements best describes the purpose of a FEDSTRIP?
1. A code to establish a supply account at postal supply centers for your MPO
  2. A code to establish a line of credit. at the supply center
  3. A code to establish a line of credit for supply items at the JMPA-ATL
  4. A code to establish a line of credit
- 9-14. What is the purpose of TTOES?
1. Speed up order process
  2. Provide immediate feedback
  3. Reduce keypunch errors
  4. All of the above
- 9-15. All users are required to register before using the TTOES system.
1. True
  2. False
- 9-16. PS Formx DDD is used to order what items?
1. Express mail envelope
  2. Priority mail envelope
  3. Global mail supply items
  4. All of the above
- 9-17. Emergency requisitions should be submitted by electrical message and in the same format as what PS Form?
1. PS Form 1586
  2. PS Form 1590
  3. PS Form 4686-A
  4. PS Form 7380
- 9-18. MDC will normally field requisitions within what time period after receipt of a requisition?
1. 24 hours
  2. 48 hours
  3. 3 days
  4. 7 days
- 9-19. Supply clerks monitor supplies using what PS Form?
1. PS Form 1586
  2. PS Form 1590
  3. PS Form 7380
  4. PS Form 7381
- 9-20. Special order rubber stamps should be ordered on PS Form 1586.
1. True
  2. False
- 9-21. Which of the following PS Form is used to requisition preprinted facing slips or labels?
1. PS Form 1578-A
  2. PS Form 1578-B
  3. PS Form 4686-A
  4. PS Form 7380

- 9-22. When accountable equipment is no longer needed at an operational MPO, what activity should be notified by message?
1. JMPA-ATL only
  2. JMPA-PAC only
  3. The serving JMPA for coordination with USPS
  4. MPSA
- 9-23. Who should you report non-capital and non-sensitive equipment in excess stock to?
1. JMPA
  2. MPSA
  3. USPS
  4. FLTCINC postal officer
- 9-24. Originally, how are USPS publications distributed to MPOs?
1. Submit a naval message to MPSA
  2. They are automatically distributed to all active MPOs
  3. The postal officer must request all publications via telephone
  4. The postal assistance advisors deliver the publications to all MPOs when issued
- 9-25. Who writes DOD postal publications?
1. MPSA
  2. JMPA
  3. USPS
  4. TYCOM
- 9-26. DOD postal publications are reissued by the Navy Department as what type of instructions?
1. OPNAV instructions
  2. DOD instructions
  3. JMPA instructions
  4. COMNAVDAC instructions
- 9-27. Official mail is any letter, publication, parcel or other mailable item relating exclusively to the business of the U.S Government.
1. True
  2. False
- 9-28. What is the overall goal of the NOMCCP?
1. Reduce insured mail cost
  2. Reduce registered mail cost
  3. Reduce official mail cost
  4. Reduce certified mail cost
- 9-29. What instructions provides the necessary guidelines for Navy commands to establish official mail cost control program?
1. DOD 4525.8-M
  2. OPNAVINST 5218.7
  3. Both 1 and 2
  4. POM
- 9-30. What is the purpose of the OMCCP program?
1. To ensure official mail is prepared and processed efficiently
  2. Processed in a timely manner
  3. Save money
  4. All of the above
- 9-31. Who appoints your command OMM?
1. Commanding officer
  2. Executive officer
  3. Admin officer
  4. COPE
- 9-32. OMMs must be what paygrade?
1. LTJG
  2. ENS
  3. Chief Petty Officer or GS-7
  4. All of the above

- 9-33. Official mail must conform to what criteria for the class of mail being used?
1. Weight
  2. Sized
  3. Shape
  4. All of the above
- 9-34. A returned address is not required for official mail.
1. True
  2. False
- 9-35. Which of the following is not authorized to be sent official registered mail?
1. Government own fire arm
  2. Service records
  3. Cash
  4. Library books
- 9-36. MOM service is not available on articles mailed in and addressed for delivery in the United States.
1. True
  2. False
- 9-37. Shore activities without a back up postage meter may maintain what number of day's backup supply of postage stamps?
1. 5
  2. 7
  3. 10
  4. 30
- 9-38. Deployable units may maintain what number of days backup supply of postage stamps when deployed in a area without metering equipment?
1. 7
  2. 10
  3. 30
  4. 90
- 9-39. Small volume mailers for official mail must not exceed what number of day's supply of postage stamps?
1. 30
  2. 60
  3. 90
  4. 120
- 9-40. Once postage stamps are received from the serving post office they should be logged on what PS Form?
1. PS Form 3295
  2. PS Form 5218/2
  3. PS Form 6701
  4. PS Form 8909
- 9-41. Audit of official mail stamps should be audited how often?
1. Daily
  2. Weekly
  3. Monthly
  4. Quarterly
- 9-42. What total number of auditors must audit the official mail stamp account?
1. One
  2. Two
  3. Three
  4. Four
- 9-43. What form is used to audit the official mail account?
1. PS Form 3295
  2. PS Form 2259
  3. MPO 6019
  4. NAVSUP Form 5218/2
- 9-44. How long should the official mail audit form remain on file?
1. 1 year
  2. 2 years
  3. 3 years
  4. 4 years



- 9-45. Commands who desire to use computer-generated postage must obtain a meter license from what organization?
1. JMPA
  2. MPSA
  3. UPS
  4. USPS
- 9-46. Component headquarters, MACOMs, and intermediate commands must conduct internal OMM inspections how often?
1. Monthly
  2. Quarterly
  3. Semi-annually
  4. Annually
- 9-47. You can process claims against USPS for indemnity on official mail items.
1. True
  2. False
- 9-48. What is the most commonly cause for loss and damage in the mail system?
1. Inadequate packaging
  2. Inexperience postal clerk
  3. Wrong address
  4. Not properly labeled
- 9-49. Official mail must not be deposited in collection boxes.
1. True
  2. False
- 9-50. Official mail bearing postage must be dispatched separated from regular mail.
1. True
  2. False

# ASSIGNMENT 10

Textbook Assignment: "Post Office Audits, Reports, and Inspections" chapter 14, pages 14-1 through 14-32.

---

- 10-1. What tools are designed to ensure correct administrative and operational policies of the MPS are being adhered to?
1. Audits
  2. Reports
  3. Inspections
  4. All of the above
- 10-2. There are how many types of official audits?
1. One
  2. Two
  3. Three
  4. Four
- 10-3. What form is used to audit the postal account of you clerks?
1. PS Form 3294
  2. PS Form 3368
  3. PS Form 2259
  4. DD Form 2259
- 10-4. What form is used to record the results of all required audits?
1. PS Form 3294
  2. PS Form 3368
  3. PS Form 2259
  4. DD Form 2259
- 10-5. When should a special audit be conducted on your fixed credit account?
1. Change of COPE
  2. Change of window clerk
  3. Each quarter
  4. Monthly
- 10-6. What audit if any should be conducted when a postal clerk is AWOL or being hospitalize?
1. Monthly
  2. Quarterly
  3. Special
  4. None
- 10-7. What types of accounts are required to be audited and reported daily?
1. Money orders and vending
  2. Money orders and stamp credit
  3. Money orders and postage meter
  4. Money orders and change fund
- 10-8. Who is responsible for preparing and submitting the money order report?
1. COPE
  2. Commanding officer
  3. Clerk who sold the money orders
  4. Postal officer

- 10-9. Who is responsible for preparing and submitting the postage meter report?
1. COPE
  2. Commanding officer
  3. Clerk who sold the money orders
  4. Postal officer
- 10-10. The post office must be inspected weekly by what official?
1. COPE
  2. Commanding officer
  3. Executive officer
  4. Postal officer
- 10-11. How many numbered four-week accounting periods does the USPS has each year?
1. 10
  2. 13
  3. 16
  4. 19
- 10-12. How often should PARS report be submitted by the COPE?
1. Weekly
  2. Monthly
  3. Quarterly
  4. Annually
- 10-13. When determining a commands fixed credit as a general guide this amount is calculated at what minimum amount per person?
1. \$10
  2. \$15
  3. \$20
  4. \$25
- 10-14. What is the minimum amount of fixed credit a command can have?
1. \$1,000
  2. \$3,000
  3. \$5,000
  4. \$9,000
- 10-15. To replenish stamp stock, the COPE must submit a stamp requisition once the cash on hand reaches what percent of the fixed credit?
1. 10%
  2. 15%
  3. 20%
  4. 25%
- 10-16. Who may audit a MPC's account?
1. COPE
  2. Postal officer
  3. Audit board members
  4. All of the above
- 10-17. What is the tolerance limit for a \$1,000 fixed credit account?
1. \$ 2.00
  2. \$10.00
  3. \$20.00
  4. \$40.00
- 10-18. What is the tolerance limit for a \$10,000 fixed credit account?
1. \$ 2.00
  2. \$10.00
  3. \$20.00
  4. \$40.00
- 10-19. Tolerance limits for flexible credit accounts are based on what percent of the flexible account?
1. 1%
  2. 2%
  3. 5%
  4. 10%

- 10-20. Overages and shortages within tolerance limits are carried forward to the next audit.
1. True
  2. False
- 10-21. What form should auditors use when conducting an audit?
1. DD Form 2295
  2. DD Form 2259
  3. DD Form 3369
  4. DD Form 1096
- 10-22. What form is used to audit a stamp vending machine?
1. PS Form 3295
  2. PS Form 3293
  3. PS Form 3306
  4. PS Form 2259
- 10-23. What is the tolerance limit for a stamp vending machine?
1. \$10
  2. \$20
  3. \$30
  4. \$40
- 10-24. Submission of each monthly audit is not required, except the quarterly audit.
1. True
  2. False
- 10-25. What form is used to maintain a stamp credit examination record for each postal clerk that possesses an extended fixed or flexible account?
1. PS Form 3369
  2. PS Form 3368
  3. DD Form 1590
  4. DD Form 2257
- 10-26. What interval should a shipboard MPS request a postal assessment visit by Postal Advisors?
1. 6 months
  2. 12 months
  3. 18 months
  4. 24 months
- 10-27. What interval should an overseas shore-based MPS request a postal assessment visit by Postal Advisors?
1. 6 months
  2. 12 months
  3. 18 months
  4. 24 months
- 10-28. PARS are designed to collect and report standard work data generated at Navy postal activities.
1. True
  2. False
- 10-29. When should PARS reports be submitted to the FLTCINC postal officer?
1. Weekly
  2. Monthly
  3. Quarterly
  4. Annually
- 10-30. What is the purpose of the Postal Advisor Program?
1. Audit a command's stamp account
  2. Evaluate the daily postal operations
  3. Provide technical training
  4. Both 2 and 3
- 10-31. Postal advisors are usually senior postal clerks of what rank?
1. E-5s to E-9s
  2. E-6s to E-8s
  3. E-7s to E-9s
  4. E-4s and Above

- 10-32. The preparation of naval messages is a routine task of postal clerks in the Navy.
1. True
  2. False
- 10-33. What is the purpose of the Postal Net Alert?
1. Report thief of stamp stock
  2. Mail on-hand report
  3. Mail routing instructions
  4. Status of mail movement
- 10-34. Mail on hand/dispatch reports are sent in message format with what precedence?
1. Routine
  2. Priority
  3. Urgent
  4. Emergency
- 10-35. Who is responsible for submitting the mail routing message?
1. Commanding officer
  2. Postal officer
  3. Supply officer
  4. COPE
- 10-36. Who is responsible for making sure USPS is reimbursed for the loss of funds, postage stock, and accountable mail because of embezzlement?
1. Department of the Navy
  2. Department of the Defense
  3. MPSA
  4. JMPA
- 10-37. An investigating officer for a postal offense may be in the rank of E-6 or above.
1. True
  2. False
- 10-38. What manual list various postal offenses that must be reported?
1. DOD Postal Manual
  2. Domestic Mail Manual
  3. POM
  4. SOP
- 10-39. Postal offenses must be reported within how hour after discovery?
1. 36 hours
  2. 46 hours
  3. 72 hours
  4. 96 hours
- 10-40. As a minimum, your filing system should be organized into how many main sections?
1. 3
  2. 5
  3. 7
  4. 9
- 10-41. Protection given to mail is always of utmost concern.
1. True
  2. False
- 10-42. Agencies desiring to examine USPS records must have written approval from the postal officer.
1. True
  2. False
- 10-43. To whom should you inform when you receive a request to examine USPS records?
1. COPE
  2. Supply officer
  3. Disbursing officer
  4. Postal officer

10-44. What is the retention period for an insured domestic mail claim form?

1. 1 year
2. 2 years
3. 3 years
4. 4 years

10-45. What is the retention period for money order reports?

1. 1 year
2. 2 years
3. 3 years
4. 4 years

10-46. You should keep directory card what total numbers of months?

1. 3
2. 6
3. 9
4. 12

10-47. All records used with the Unisys III will be retained for what total number of years?

1. 1
2. 2
3. 3
4. 4

10-48. All MPS activities must review and update their SOP how often?

1. Monthly
2. Quarterly
3. Semi annually
4. Annually

10-49. All MPS activities must review and update their POP how often?

1. Monthly
2. Quarterly
3. Semi annually
4. Annually

10-50. The basic POP consists of seven sections.

1. True
2. False