

(No Model.)

F. B. GOULD.

LOCKET.

No. 302,722.

Patented July 29, 1884.

Fig:1.

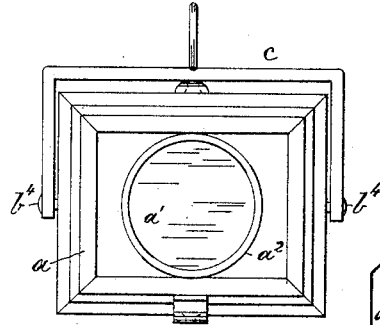

Fig:3.

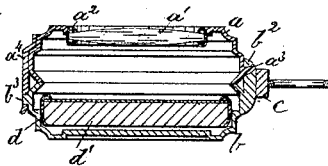

Fig:4.

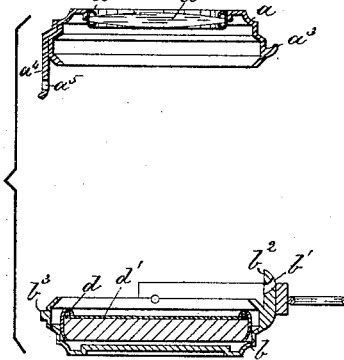

Fig: 2.

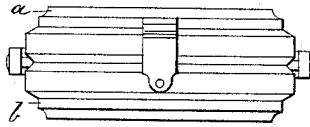

Fig: 5.

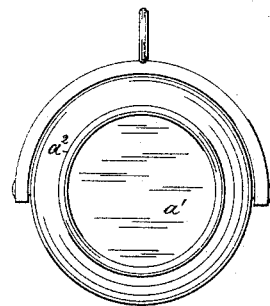

Fig:7.

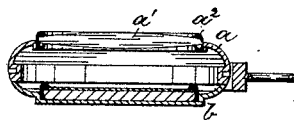

Fig:8.

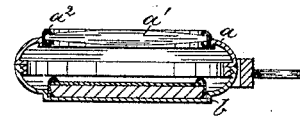

Fig: 6.



Witnesses.  
*Bernice J. Hayes*  
*John F. C. Painter*

Inventor.  
*Forrest B. Gould.*  
*by Crosby & Gregory*

# UNITED STATES PATENT OFFICE.

FORREST B. GOULD, OF BOSTON, MASSACHUSETTS.

## LOCKET.

SPECIFICATION forming part of Letters Patent No. 302,722, dated July 29, 1884.

Application filed November 19, 1883. (No model.)

*To all whom it may concern:*

Be it known that I, FORREST B. GOULD, of Boston, county of Suffolk, State of Massachusetts, have invented an Improvement in Magnifying-Lockets, of which the following description, in connection with the accompanying drawings, is a specification, like letters on the drawings representing like parts.

This invention has for its object the production of a simple and inexpensive locket adapted to receive a small or reduced picture or photograph, the locket being provided with a lens to magnify the said picture when desired.

United States Patent No. 277,022, heretofore granted to me, shows and describes an extensible locket, one half of which contains the picture to be viewed and magnified, while the other half contains the magnifying-glass, the said two halves being connected by means of links. In this my present invention I desire to dispense with the said links, yet leaving the two halves of the locket separable to any desired distance, in order to adjust the magnifying-glass to the desired focal distance from the picture, thus affording a greater range of adjustment than when the said halves are connected by links of such number as to be compactly folded when the locket is closed; and, further, by avoiding all connections between the two halves of the locket, except the fastening devices to keep the locket closed, I am enabled to use the magnifying-glass to examine any article outside of the locket, thus making one half of the locket serviceable as a cheap form of magnifying-glass for general use. In dispensing with the said links I have devised means to hold the two halves of the locket firmly together when the same is not being used to view the picture.

Figure 1 represents in side elevation a locket embodying my present invention; Fig. 2, an under side view of Fig. 1; Fig. 3, a central cross-section of Fig. 2; and Fig. 4 represents the two halves of the locket separated as when the picture is to be viewed, the half containing the magnifying-glass being held in one hand and adjusted to focal distances, while the other half rests upon some other support. Fig. 5 represents a modified form of locket;

Fig. 6, an under side view thereof; and Fig. 7, a cross-section, and Fig. 8 shows yet another modification of my invention.

The locket herein described is composed of two halves or parts, *a b*, of usual shape and material. The half *a*, containing the magnifying-glass *a'*, which is held in a suitable frame, *a''*, has at its edges parts of fastening devices which co-operate with other parts of fastening devices attached to the half *b*. The fastening parts applied to half *a* in Figs. 1 to 4 consist of a projection, *a<sup>3</sup>*, and a catch, *a<sup>4</sup>*, provided, as herein shown, with a recess, *a<sup>5</sup>*. The projection *a<sup>3</sup>* enters a recess, *b'*, in an ear, *b<sup>2</sup>*, attached to half *b*, and the recess *a<sup>5</sup>* of the catch *a<sup>4</sup>* engages the projection *b<sup>3</sup>* when the two halves are forced together, and the said fastening devices retain the two separable halves of the locket together, as shown in Figs. 2 and 3. The bale *c* is joined with pivots *b<sup>4</sup>* on the half *b*. The half *b* contains the frame *d*, to hold the picture *d'* to be viewed and magnified when the two halves of the locket are entirely separated, the person desiring to view the picture at such time adjusting the half containing the glass *a'* at the proper focal distance from the picture in the half *b*, such distance being more or less according to his or her eye.

I am aware that lockets and watches have had their faces hinged to their backs, and have been arranged to snap the one over an annular rim on the other; but such I do not claim. I am not aware that a locket was ever before made in which one half to contain a magnifying-glass was ever made readily separable from the other half containing the picture.

As a modification of my invention, to adapt the same to a round-frame locket, the fastening devices may be modified—as, for instance, the half *a* may be provided with one or more pins or projections, *f*, which will engage one or more recesses, *g*, in the half *b*, as best shown in Fig. 6, the fastening device being what is known as a "bayonet" joint connection.

In Fig. 8 I have shown yet another form of fastening device, the same being a screw-thread upon half *a*, which enters screw-threads in half *b*.

From the foregoing it will be understood

that I do not desire to limit my invention to the employment of one particular kind of fastening device, but that the said fastening devices may be variously modified without  
5 departing from my invention.

I claim—

As an improved article of manufacture, a  
loket composed of two halves, *ab*, one having  
a frame to hold a picture, and the other a  
10 magnifying-glass and a frame to hold it, the  
two halves of the locket having fastening  
devices to hold them together and retain the  
loket closed, the two halves of the locket be-  
ing entirely disconnected from each other

when the fastening devices are disengaged, to  
15 permit the half having the magnifying-glass  
to be adjusted to any desired or proper focal  
distance, or enable the half having the mag-  
nifying-glass to be used to examine any de-  
sired article outside the locket, substantially  
20 as set forth.

In testimony whereof I have signed my name  
to this specification in the presence of two sub-  
scribing witnesses.

FORREST B. GOULD.

Witnesses:

G. W. GREGORY,  
B. J. NOYES.