

W. F. HUMPHREYS.
STOVE REFRIGERATOR.

No. 186,933.

Patented Feb. 6, 1877.

Fig 1.

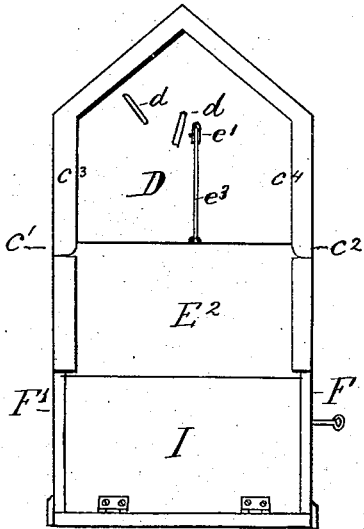

Fig 2.

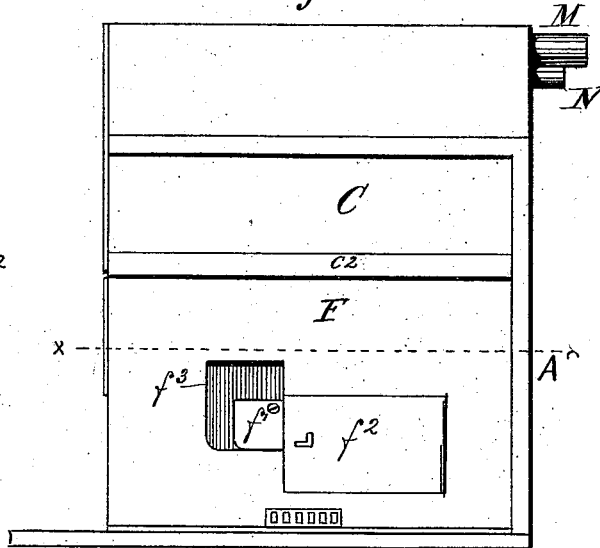
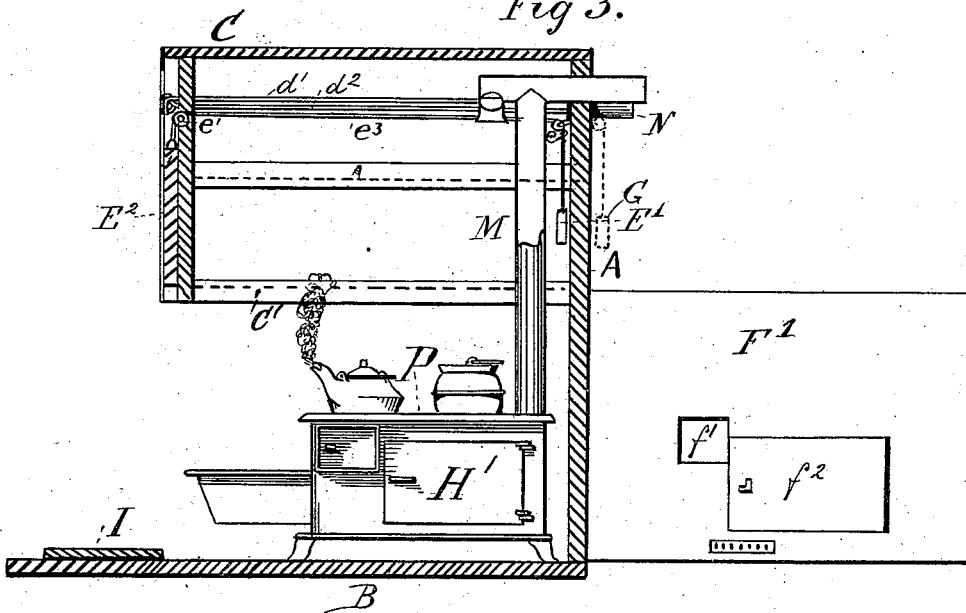

Fig 3.



Witnesses.

B. C. Pole

W. H. Alderman

Inventor.

William F. Humphreys.

By Jno B. Clark Jr.
attorney.

W. F. HUMPHREYS.
STOVE REFRIGERATOR.

No. 186,933.

Patented Feb. 6, 1877.

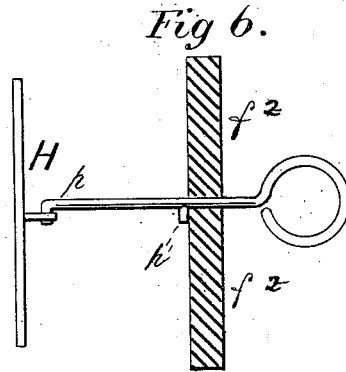
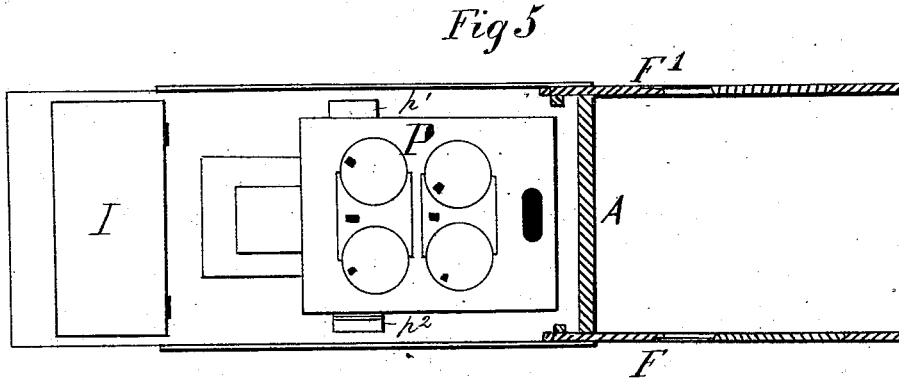
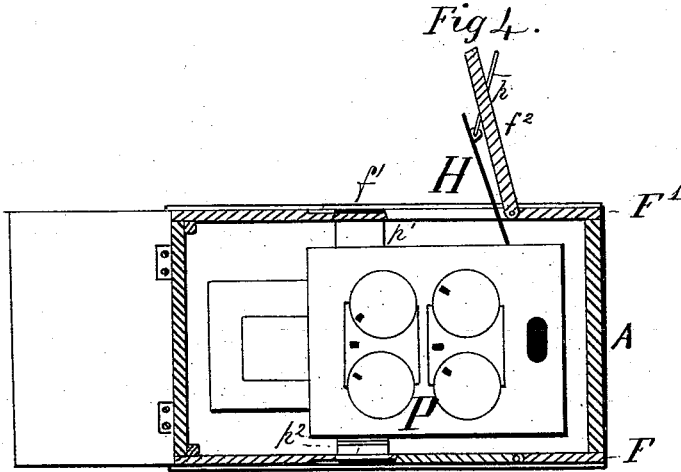

Witnesses
B. C. Pole
J. C. Midman.

Inventor
William F. Humphreys
By John B. Clark Jr.
attorney.

W. F. HUMPHREYS.
STOVE REFRIGERATOR.

No. 186,933.

Patented Feb. 6, 1877.

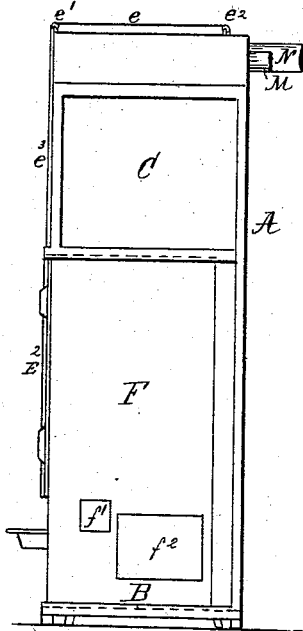

Fig 7.

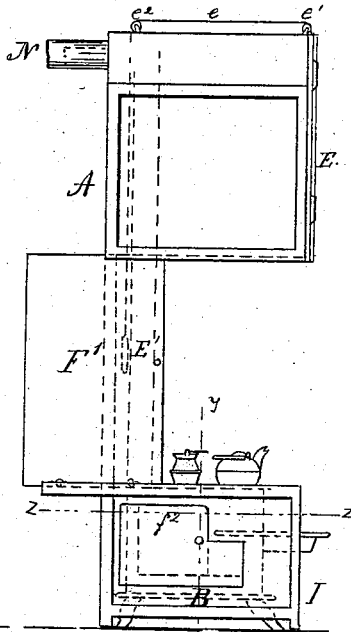

Fig 9.

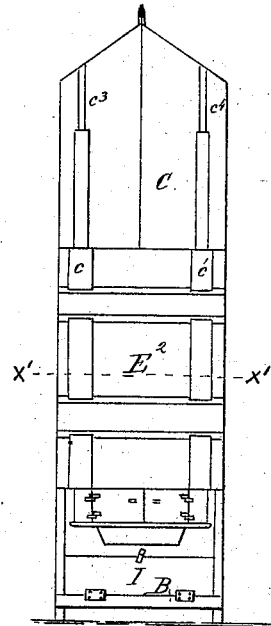

Fig 8.

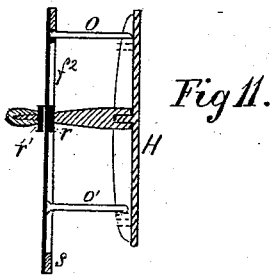

Fig 11.

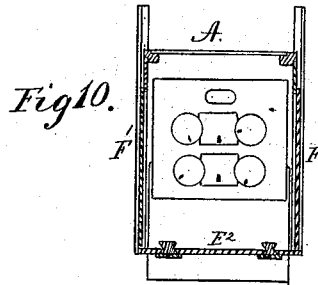

Fig 10.

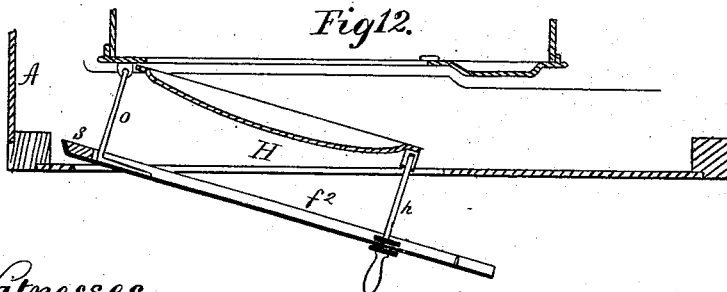

Fig 12.

Witnesses
B. C. Pole
J. C. Wildman.

Inventor.
William F. Humphreys
By J. D. Clark
Attorney

UNITED STATES PATENT OFFICE.

WILLIAM F. HUMPHREYS, OF CONCORD, MISSOURI.

IMPROVEMENT IN STOVE-REFRIGERATORS.

Specification forming part of Letters Patent No. 186,933, dated February 6, 1877; application filed August 16, 1876.

To all whom it may concern:

Be it known that I, WILLIAM FINLEY HUMPHREYS, of Concord, in the county of Callaway and State of Missouri, have invented certain new and useful Improvements in Stove-Refrigerators; and I do hereby declare that the following is a full, clear, and exact description thereof, which will enable others skilled in the art to which it appertains to make and use the same, reference being had to the accompanying drawings, and to the letters of reference marked thereon, which form a part of this specification.

This invention relates to that class of household contrivances made use of to prevent the heat and odors of a cook-stove or range, entering a house; and the nature thereof consists in providing certain sliding doors, and in adjusting additional ones, so that the fire may be replenished or the oven opened without opening the larger door; also, in the arrangements of certain dampers to regulate the means of escape of the hot air, all of which is more fully hereafter described in the drawings.

Figure 1 is front elevation of my apparatus. Fig. 2 is side elevation of Fig. 1. Fig. 3 is sectional side elevation of Fig. 2. Fig. 4 is sectional plan on line *xx* of Fig. 2, with sliding doors closed and oven-doors open. Fig. 5 is sectional plan same as Fig. 4, but with sliding doors open. Fig. 6 is sectional view of oven and apparatus door. Fig. 7 is a side elevation of the apparatus when closed, and in which the front of the stove projects. Fig. 8 represents the front elevation of the apparatus when closed, and shows the front doors of the stove exposed. Fig. 9 is a side elevation of the apparatus, similar to Fig. 8, when thrown open. Fig. 10 is a sectional plan on line *x'x'*, Fig. 8. Fig. 11 is a sectional view of a modification of the double door H on line *yy* of Fig. 9. Fig. 12 is sectional view of modified double door H on the line *zz*, showing it partly open.

To enable those skilled in the art to make and use my invention, I will proceed to describe its construction and operation, and will refer by letter to the drawings, in which the same letters refer to the same parts.

I construct an upright back, A, which is

firmly secured to either a separate bottom piece, B, or to the floor of the dwelling. To the upper portion of this back and to the front is a projecting hood, C, having the guides c^3 and c^4 , grooves C^1 and C^2 . Dampers d , in front of hood at D, are to be so arranged as to enable the operator to open and close the smoke-pipe M and the hot-air pipe N at pleasure. There are also pulleys e e^2 , through which passes the cord e^3 at one end, sustaining the weight E^1 at the back A, and at the other end the door E^2 . This weight may be placed inside near the stove-pipe, or entirely above the ceiling. There are, provided the main sliding doors F F^1 , and in the door F are the doors f^1 and f^2 , similarly constructed. The door f^1 is for the purpose of replenishing the fire, and the door f^2 is for the purpose of opening the oven-door. The door F^1 does not always extend lower down than the top of the stove, as is shown in Fig. 9.

The double door H, shown in Figs. 4 and 12, consists of an exterior door, f^2 , attached to the stove-door H' , so that they move together, as shown in Figs. 4 and 12. f^2 may be made conveniently of tin, having a frame of wood or brass, so as to make it firm. The door f^2 is attached to the stove-door H' by means of rods o and o' , which are riveted to H' , and serve at the same time as pins for the hinges of the stove-door. By the key p , which can be attached to the stove-door H' by means of a rivet or hook through the projecting knob of H' , Fig. 6, the key can terminate in a wooden handle. By means of this arrangement, the whole forms one double door, which may be opened with more ease than the stove-door alone could be. The part f^2 is larger than the stove-door H' , and the lower portion extends over the small oven-door, as shown in Figs. 6 and 9. Doors E^2 , F, and F' , may be dispensed with, and closing-shutters used instead; and by removing one section of shutter, the oven and fire can be attended to. As there is some little space between the fire and sliding doors, there are placed upon the stove projecting boxes p^1 p^2 . These are made to come out far enough to allow the sliding doors to pass, but they will prevent the escape of heat while the swinging door is open. Where the shutters are used the hood C can

be hung from the wall of the dwelling, still retaining all the means of closing the stove out from the room, the wall of the dwelling taking the place of the back A. The door I, Figs. 1, 3, and 8, may be opened on hinges, so as to enable the operator to clean the lower part of the stove.

That my apparatus may be readily adjusted it is only necessary to place the stove-pipe M in position in the flue, as also the air-pipe N. With these two pipes in the flue, either may be used to clear the interior of the apparatus of smoke and heat, which is done by simply opening either of the valves *d*. Should the draft not be sufficient to allow the air-pipe N to be inserted in the flue, it can be carried to any convenient point, or may be extended by additional lengths of pipe up the flue, insuring a draft. Either pipe may be thus treated.

As is clearly shown in the drawing, when the doors of the stove are all open, the entire top of the stove is clear to be used, with no obstruction; and when the apparatus is closed, the entire stove is inclosed within the same.

Suitable air-entrances can be provided at the bottom of the doors. The whole apparatus may be constructed of metal or wood, or both, and of any desired size.

Having thus described my invention, what I claim, and desire to secure by Letters Patent, is—

1. For a cook-stove the combination, in the hood C, of guides *c*¹ and *c*², grooves *c*³ and *c*⁴, sliding doors E² and F and F', doors *f*¹ and *f*², and compound door H, substantially as shown and described.

2. In a cook-stove or kitchen-range, a hood, C, provided with sliding doors F F', and double doors H, dampers, rods, and additional air-pipe N, substantially as herein described.

In testimony that I claim the foregoing as my own I affix my signatures in presence of two witnesses.

WILLIAM FINLEY HUMPHREYS.

Witnesses:

WM. A. ZUMALT,
D. C. HUMPHREYS.