

E. F. WOODBURY.

MACHINE FOR ROLLING WHIPS.

No. 187,995.

Patented March 6, 1877.

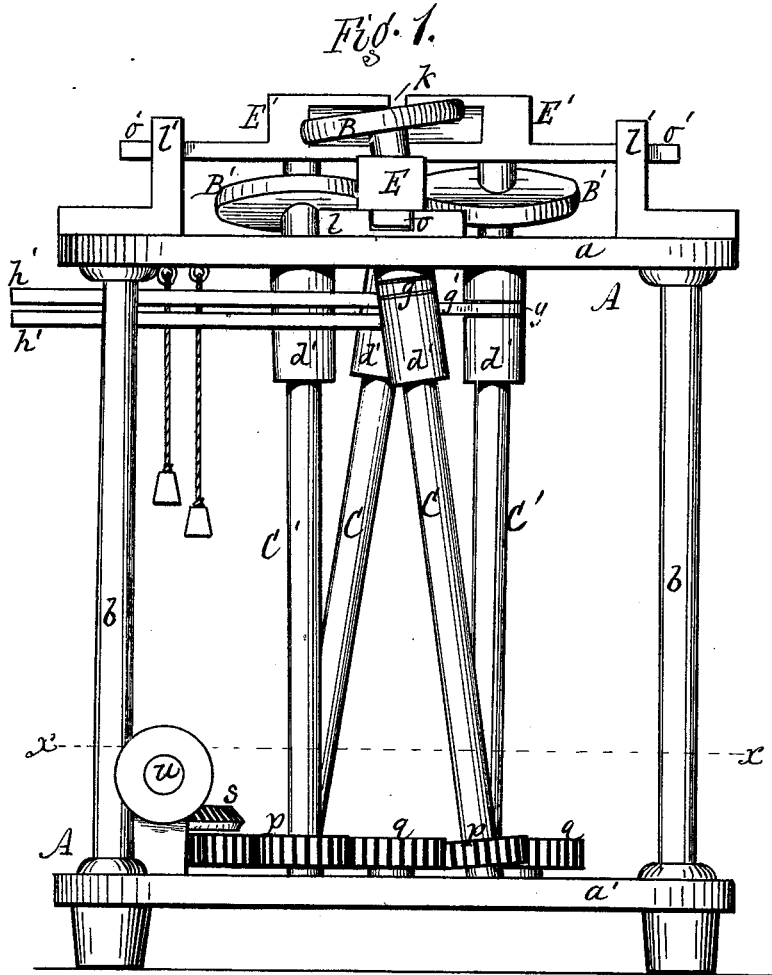

Attest.
 Edwin Scott
 Louis Spahn.

Inventor.
 Edmund F. Woodbury
 per R. F. Osgood
 atty

E. F. WOODBURY.
MACHINE FOR ROLLING WHIPS.

No. 187,995.

Patented March 6, 1877.

Fig. 2.

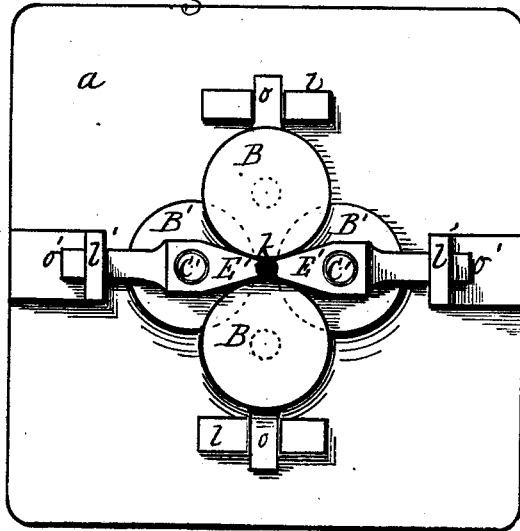

Fig. 4.

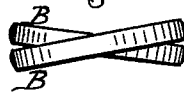

Fig. 5.

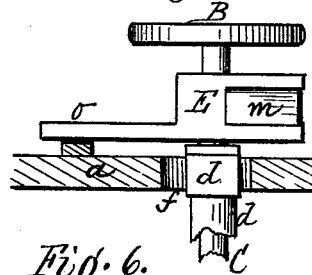

Fig. 3.

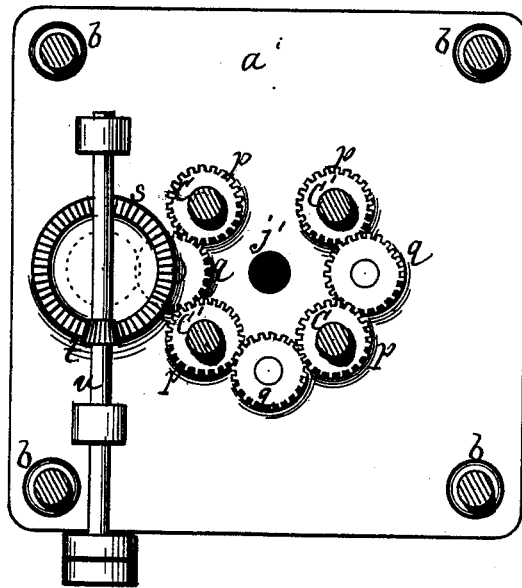

Fig. 6.

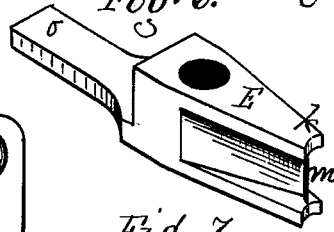

Fig. 7.

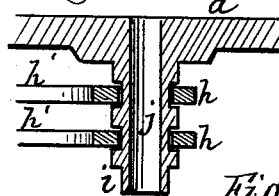
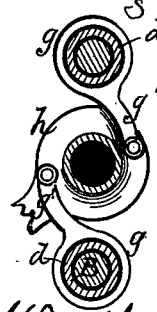

Fig. 8.



Attest.
Edwin Scott.
Louis D. Spahn.

Inventor.
Edmund F. Woodbury,
per R. T. Osgood,
attn

UNITED STATES PATENT OFFICE.

EDMUND F. WOODBURY, OF ROCHESTER, NEW YORK.

IMPROVEMENT IN MACHINES FOR ROLLING WHIPS.

Specification forming part of Letters Patent No. 187,995, dated March 6, 1877; application filed January 31, 1877.

To all whom it may concern :

Be it known that I, EDMUND F. WOODBURY, of the city of Rochester, in the county of Monroe and State of New York, have invented a certain new and useful Improvement in Machines for Rolling Whips; and I do hereby declare that the following is a full, clear, and exact description of the construction and operation of the same, reference being had to the accompanying drawings, in which—

Figure 1 is an elevation of my improved machine. Fig. 2 is a plan of the same. Fig. 3 is a horizontal section in line *x x* of Fig. 1. Fig. 4 is a diagram, showing the angular position of the rolling wheels. Figs. 5, 6, 7, and 8 are detail views.

My improvement relates to a machine for rolling whips, after the covering is applied, for the purpose of finishing the same and flattening the covering. Such work has usually been done by hand, the whip being placed flatwise on a bed or table, and rolled to and fro beneath a presser held by both hands of the operator. Besides being very imperfectly done, the work is very slow and laborious; and the object of my improvement is to substitute machinery for hand-labor.

The invention consists in the combination of parts, hereinafter more fully described and definitely claimed.

A is a frame, consisting of an upper and lower leaf, *a* and *a'*, connected by vertical standards *b b*. In this frame are mounted two pairs of rollers, *B B* and *B' B'*, situated on shafts *C C* and *C' C'*, and located above the upper leaf, *a*. These two pairs are located at right angles to each other, one above the other. The rollers of each pair stand inclined in opposite directions, as shown in the diagram, Fig. 4, so that the whip, which is entered between them at the top, will be gradually fed down as the rollers revolve. These rollers concentrate to the center point of the machine, where there is a hole for the whip to pass through, and when spring-pressure is applied to the rollers they bear upon the surface of the whip, and roll every part of the same from butt to tip as it passes through. I design the upper rollers more particularly for feed-rollers; and their edges may be corrugated, if desired, while the lower rollers serve the purpose of

finishing-rollers, pressing the covering to the whip, and producing the necessary finish.

Three rollers instead of four might be made effective; or a greater number than four may be used, if desired. The bottoms of the shafts *C C'* may be suitably stepped in the lower leaf, *a'*; and said shafts stand in the inclined position shown, to accommodate the angular position of the rollers. At their upper ends they pass loosely through square blocks or bearings *d d*, Fig. 5, which slide forward and back in slots *f f* in the leaf *a*, to allow the opening and closing movements of the rollers; and at the bottoms of these square blocks are cylindrical extensions *d' d'*, around which, in suitable grooves, are situated loose rings *g g*, Fig. 8. These rings have arms *g' g'*, pivoted to eccentrics *h h*, which turn loosely on a pendant, *i*, depending centrally from the upper leaf *a*, and provided with a tubular passage, *j*, for the whip to pass through. The eccentrics *h h* have levers *h' h'* extending outward, with which are connected suitable springs or weights, which have a tendency to constantly close the rollers upon the whip by drawing upon their shafts through the medium of the arms *g' g'*. *E E E' E'* are guides, in which the upper ends of the shafts of the rollers rest and turn freely. The inner ends of these guides are made wedging, and concentrate between the opposite pair of rollers, as shown in Fig. 2, leaving only space between the ends for the tip of the whip. These ends are blunt, and are made concave, as shown at *k k*. The opposite or outer ends *o o* of the guides pass loosely through bearings *l l*, which keep them in proper position in moving in and out. The central portion of the guides have grooves cut in their sides to allow the rollers to enter, leaving thereby wedge-shaped tongues *m m*. The blocks *E' E'* of the opposite rollers have arms *o' o'*, similar to the ends *o o*, which also pass through bearings *l' l'*, to keep them in position. *p p p p* are spur-gears attached to the lower ends of the shafts *C C C' C'*. *q q q* are intermediate gears, engaging with them. One of the gears *q* engages with a pinion on the bottom of the bevel-gear *s*, and the latter receives motion from a bevel-pinion, *t*, on a shaft, *u*. Any equivalent gearing may be used for giving motion to the shafts.

From the above description the operation will be readily understood. The covered whip is entered between the rollers, and, as the latter revolve, it is fed down by the spiral action of the rollers. This action is so slow that every portion of the surface of the whip receives the pressure of the rollers, which flattens the covering, and finishes the whip in a perfect manner. The opening and closing action of the rollers causes them to adjust themselves to the difference in the diameter of the whip as it is presented to the rollers in different stages of the movement. The whip passes down through the tube *j*, and thence through a hole, *j'*, in the bottom of the machine; and thence it may drop through a hole in the floor to the apartment beneath. One whip is fed into the machine after another, the work being thus continuous and rapid. The guides *E E'* serve to hold the whip straight between the rollers, which are situated at different heights, and which, if they alone bore upon the whip, might bend it or throw it out of position. They form a continuous bearing upon the whip over the whole length occupied by the rollers. If desired, the rollers which feed the whip down may be covered with leather or other soft material.

Having thus described my invention, what I claim herein as new is—

1. In a whip-rolling machine, the combination of a series of yielding rollers set in spiral form to bear upon the whip, and feed it through, as well as roll its surface, as shown and described, and for the purpose specified.

2. The combination, with the rollers *B B'* and their shafts *C C'*, of the connecting-rings and arms *g g'*, the eccentric *h*, and its lever *h'*, operated upon by a spring or a weight, to close the rollers upon the whip, as herein shown and described.

3. In a whip-rolling machine, the pendant *i*, constructed in tubular form to allow the passage of the whip, and serving as a bearing for the eccentrics *h h*, as shown and described.

4. In a whip-rolling machine, the combination, with a series of yielding rollers bearing upon the whip, of centering-guides *E E'*, closing upon the whip between the rollers, as shown and described, and for the purpose specified.

5. The guide *E*, constructed with the concave ends *k k* projecting between the rollers, as shown and described, and for the purpose specified.

6. The process of rolling whips by passing them between inclined whirls or rollers *B B'*, which roll them in one continuous direction and feed them down to the work, as and for the purpose specified.

In witness whereof I have hereunto signed my name in the presence of two subscribing witnesses.

EDMUND F. WOODBURY.

Witnesses:

R. F. OSGOOD,
EDWIN SCOTT.