

C. B. ROSE, dec'd.,

B. S. Parker, Administrator.

LOCKING-LATCHES AND HANDLES FOR THE SAME.

No. 194,925.

Patented Sept. 4, 1877.

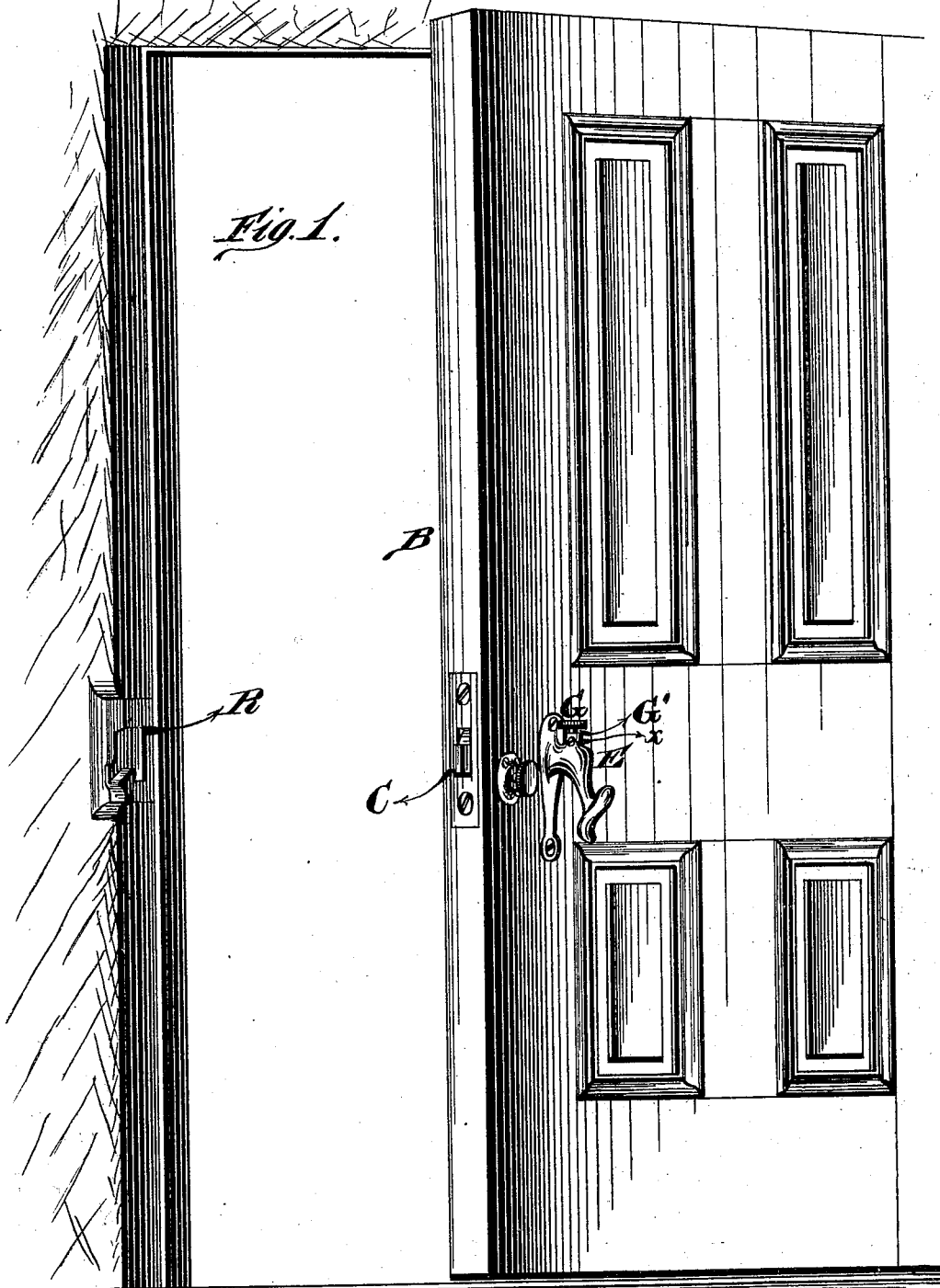

WITNESSES

*Robert Everett*  
*George E. Upham*

*Bowdoin S. Parker*  
 Administrator of Estate of  
 Clemens B. Rose, deceased.

*Gilmore, Smith & Co.*  
 ATTORNEYS.

C. B. ROSE, dec'd.,

B. S. Parker, Administrator.

LOCKING-LATCHES AND HANDLES FOR THE SAME.

No. 194,925.

Patented Sept. 4, 1877.

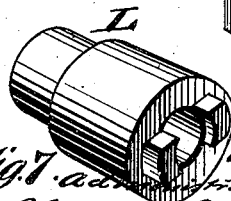
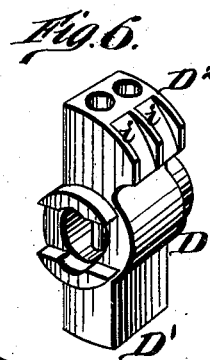
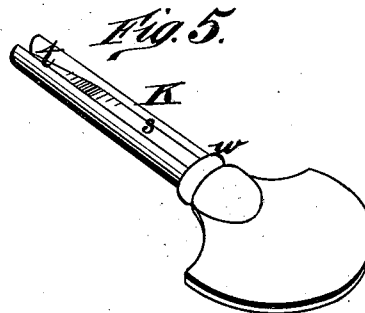
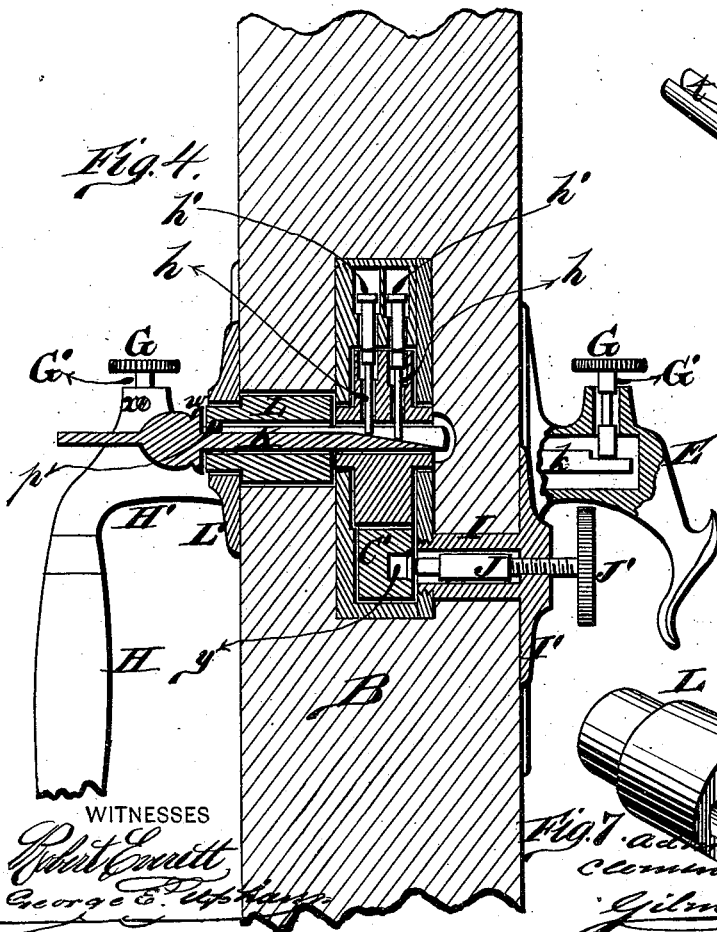
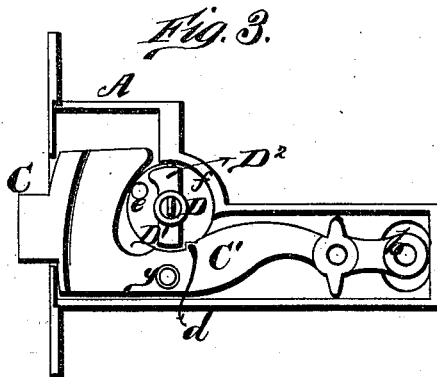
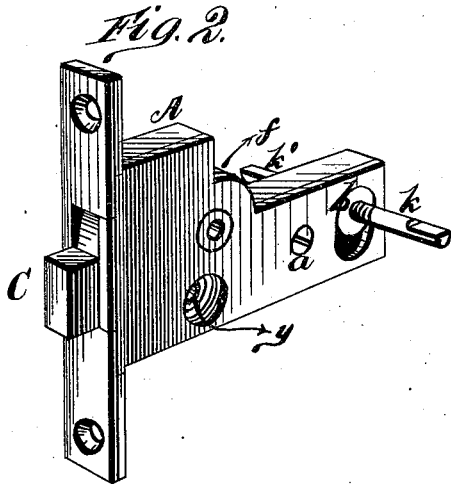

WITNESSES  
*Robert Smith*  
*George C. Stephens*

Inventor  
 B. S. Parker.  
 Administrator to estate of  
 C. B. Rose, deceased.  
*Gilmore Smith & Co.*  
 ATTORNEYS.

C. B. ROSE, dec'd.,

B. S. Parker, Administrator.

LOCKING-LATCHES AND HANDLES FOR THE SAME.

No. 194,925.

Patented Sept. 4, 1877.

Fig. 8.

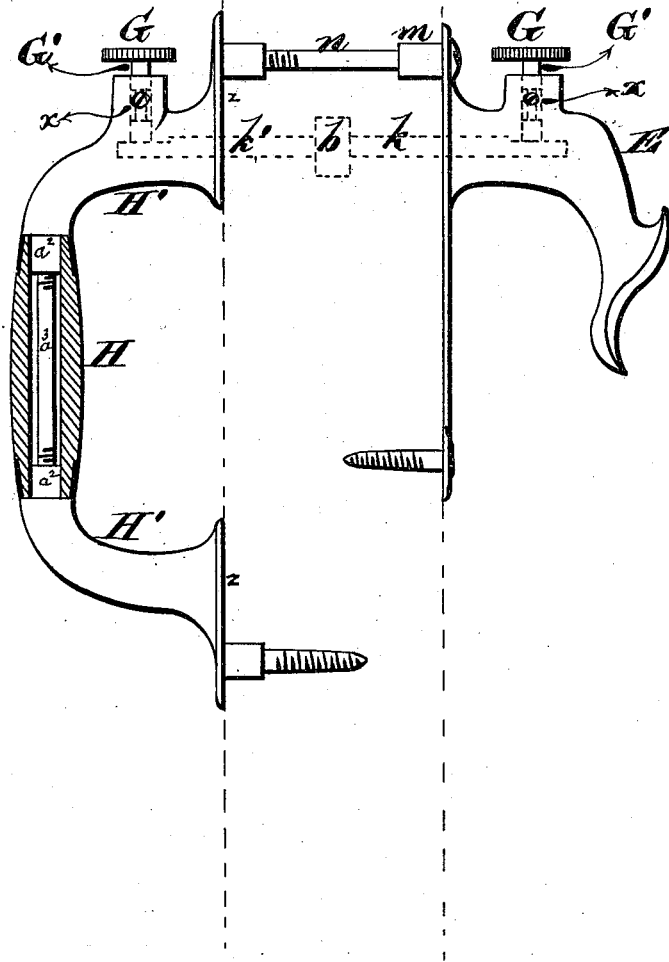

WITNESSES  
*Robert Corbett*  
*George C. Upham*

Inventor  
*Bowdoin S. Parker,*  
 Administrator to estate of  
*Clemens B. Rose, deceased*  
*Gilmore, Smith & Co.*  
 ATTORNEYS

# UNITED STATES PATENT OFFICE.

BOWDOIN S. PARKER, OF GREENFIELD, MASSACHUSETTS, ADMINISTRATOR  
OF CLEMENS B. ROSE, DECEASED.

## IMPROVEMENT IN LOCKING-LATCHES, AND HANDLES FOR THE SAME.

Specification forming part of Letters Patent No. 194,925, dated September 4, 1877; application filed  
June 23, 1877.

*To all whom it may concern:*

Be it known that CLEMENS B. ROSE, deceased, late of Miller's Falls, in the county of Franklin and State of Massachusetts, did invent a new and valuable Improvement in Door Handles, Locks, and Latches, of which I, BOWDOIN S. PARKER, of Greenfield, in the county of Franklin and State of Massachusetts, administrator to estate of said CLEMENS B. ROSE, do hereby declare the following to be a full, clear, and exact description, reference being had to the annexed drawings, making a part of this specification, and to the letters and figures of reference marked thereon.

Figure 1 of the drawings is a representation of my door handle, lock, and latch as applied. Fig. 2 is a perspective view, and Fig. 3 a plan view, of the lock. Fig. 4 is a transverse vertical sectional view of the lock and latch; Fig. 5, a view of the key, and Figs. 6 and 7 detail views. Fig. 8 is a transverse vertical sectional view of the handle, showing, also, the latch.

The nature of this invention relates to the construction and arrangement of a door lock and handle, as will be hereinafter more fully set forth.

The annexed drawings, to which reference is made, fully illustrate the invention.

A represents the lock-case, inserted in the door B, and provided with an interior latch, C. This latch is constructed substantially as shown, with an inwardly-projecting curved arm, C', pivoted, near its inner end, by a screw, *a*, and provided at its extreme inner end with a hub, *b*, which projects in elongated slots in both sides of the lock-case. In the body of the latch C is made a recess with a shoulder or offset at *d*, as shown.

D represents a hub, the ends whereof rest in circular holes made in both sides of the lock-case, and said hub is, within the case, provided with arms D<sup>1</sup> and D<sup>2</sup>, the arm D<sup>1</sup> being intended, simply, when the hub is turned in a certain position, to stand vertically over the latch against the shoulder *d*, and lock the latch, said shoulder preventing the hub, with its arms, from being turned in the wrong direction. When the hub is now turned until the arm D<sup>1</sup> strikes a stop, *e*, in the case, the latch

is unlocked, the recess in the latch allowing it to move without interfering with said arm D<sup>1</sup>.

The arm D<sup>2</sup> is, at its outer end, made curved, to correspond with an arch, *f*, formed in the lock-case, and in this arm are arranged two or more gravitating tumblers or pins, *h h*, the inner ends of which project into the bore of the hub D. In the top of the lock-case are arranged two or more gravitating tumblers or pins, *h' h'*, which correspond with the tumblers or pins *h* in the arm D<sup>2</sup>. The normal position of the pins *h'* is to project at varying distances into the lock-case.

In the top of the arm D<sup>2</sup> are inclines *i i*, extending from the front edge inward, as shown. Now, when the hub D (with its arms) is turned for the purpose of locking the latch, the inclines *i* push upward the pins *h'*, to allow the arm D<sup>2</sup> to pass; and when the arm D<sup>1</sup> strikes the shoulder *d* on the latch, the position of the arm D<sup>2</sup> will be such that the tumblers or pins *h* and *h'* will coincide, and the pins *h'* will enter the holes in the arm D<sup>2</sup> at varying depths, and thus hold the hub stationary, and securely lock the latch.

By the insertion of a proper key, hereinafter described, the pins *h h* are raised to a certain varying height, so as to bring the pins *h'* within their bores, and allow the pins to pass each other for turning the hub to unlock the latch.

To operate the latch, the following devices are employed on the inside and outside of the door, respectively:

Two arms, *k k'*, are screwed into opposite ends of the hub, and project through slots in the door. The arm *k* projects on the inner side of the door and into a handle, E, fastened to the door. On the top of this handle is a thumb-piece, G, having a shank, G', extending downward through a suitable bore in the handle, and resting on the arm *k*, so that, by pressing down on said thumb-piece, the inner end of the latch-arm C' is depressed, thereby raising the latch. The latch falls down of its own weight as soon as the pressure is removed from the thumb-piece G.

The lower end of the handle is fastened by an ordinary screw, while the upper end of said

handle is provided with a hollow stud, *m*, which is passed into the door, and a long screw, *n*, is passed through said hub and through the door, and screws into a corresponding hollow stud formed on the upper end of the outside handle. This handle is also provided with a thumb-piece, *G*, with shanks *G'*, for operating on the arm *k'* to work the latch. Each shank *G'* is turned down for a certain portion of its length at the top, and a small screw, *x*, is passed through the handle into said turned-down portion, which prevents the shank and thumb-piece from coming out of the handle, while it allows a certain amount of up-and-down motion to the same.

The outside handle (see Fig. 8) is composed of a hollow wooden center-piece, *H*, in the ends of which are inserted the cylindrical ends *a<sup>2</sup>* of the metal end pieces *H'*. The cylinders *a<sup>2</sup>* are hollow and interiorly screw-threaded, to receive the ends of the bolt *a<sup>3</sup>*, screw-threaded at both its ends.

The metallic end pieces *H'* are provided with suitable flanges or plates *z z*, by means of which they may be fastened to the door.

The latch is locked from the inside of the door by the following means:

*I* is a barrel or tube, passed through the door and screwed into the lock-case, said barrel being, at its outer end, provided with an escutcheon-plate, *I'*, fastened to the door by screws. Through the barrel *I*, which has interior threads, is screwed a screw or bolt, *J*, provided on its outer end with a knob, *J'*. By running in this screw its inner end will pass into a recess, *y*, in the side of the latch, and thus lock the same. By running out said screw its inner end will pass out of said recess, and the latch be free to move.

On the outside of the door is secured an escutcheon-plate, *L'*, having a barrel, *L*, arranged therein in such a manner that it cannot be taken out, but is free to turn in either direction. The inner end of this barrel couples to the end of the hub *D*, and within the barrel is a longitudinal rib or feather, *p*, as shown.

The key of this lock consists, simply, of a round rod or bolt, *K*, with a suitable handle

at one end. The key is provided with a longitudinal groove, *s*, the bottom of which is, at the outer end, made on an incline, as shown at *t*.

By inserting the key in the barrel *L* up to the shoulder *w* on the key, the end will pass through the hub *D*, so that the incline *t* will raise the pins or tumblers *h* in proper position for locking and unlocking the lock, as above described.

*R* is the catch in the door-jamb, on which the latch *C* takes.

What I claim as new, and desire to secure by Letters Patent, is—

1. The latch *C*, constructed as described, with arm *C'*, having hub *b* on its end, and having shoulder or offset *d*, as and for the purposes set forth.

2. The hub *D*, having bottom arm *D<sup>1</sup>* and top arm *D<sup>2</sup>*, the latter formed with the inclines *i*, and provided with interior gravitating pins *h*, in combination with the latch and the gravitating pins *h'* in the lock-case, substantially as set forth.

3. The combination of the latch *C*, having arm *C'*, with hub *b*, the rods *k k'*, projecting from said hub, and the thumb-pieces *G*, with shanks *G'*, arranged in the handles of the door, substantially as and for the purposes set forth.

4. In a door-handle, the combination of the metallic end pieces *H'*, having the flanges *z* and hollow cylinders *a<sup>2</sup>* interiorly screw-threaded, with the bolt *a<sup>3</sup>*, screw-threaded at its ends, and hollow wooden center-piece *H*, substantially as described, and for the purpose set forth.

5. The feathered barrel *L*, hub *D*, with arm *D<sup>2</sup>*, and the pins *h*, substantially as and for the purposes herein set forth.

In testimony that I claim the above I have hereunto subscribed my name in the presence of two witnesses.

BOWDOIN S. PARKER,

*Administrator to estate of Clement B. Rose, deceased.*

Witnesses:

FREDK. L. GREENE,

W. F. AIKEN.