

J. McALPINE.
Breech-Loading Fire-Arms.

No. 204,675.

Patented June 11, 1878.

Fig. 1.

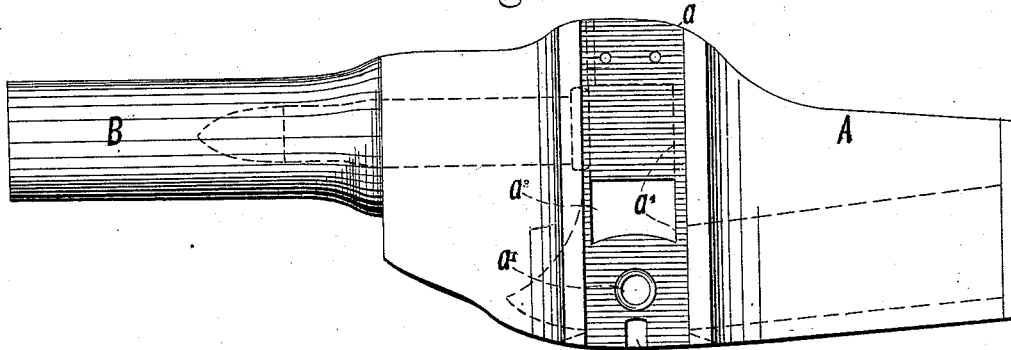

Fig. 2.

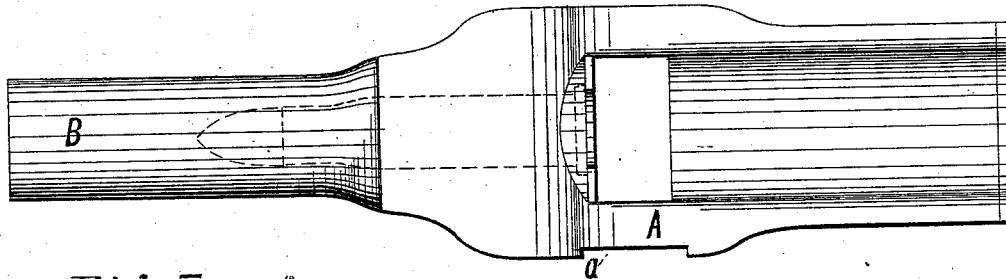

Fig. 5.

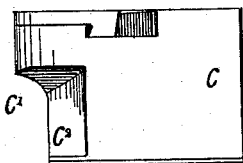

Fig. 6.



Fig. 7.

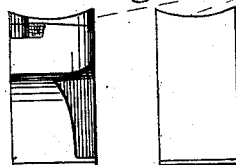
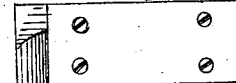

Fig. 8.



WITNESSES:

T. S. West,
Connelors

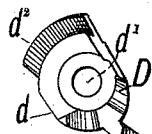

Fig. 3.

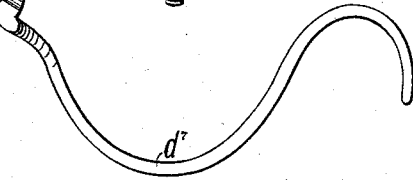

Fig. 4.

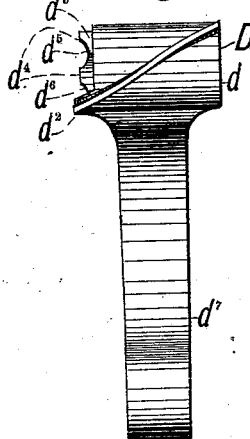

Fig. 9.

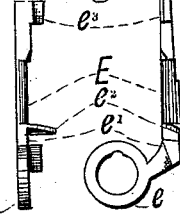
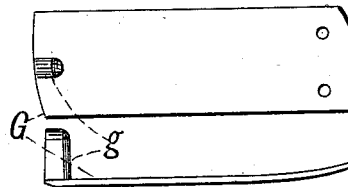

Fig. 10.



Fig. 11.



INVENTOR:
JAMES McALPINE,
BY
H. W. Beadle & Co
ATTYS

J. McALPINE.
Breech-Loading Fire-Arms.

2 Sheets—Sheet 2:

No. 204,675.

Patented June 11, 1878.

Fig. 12.

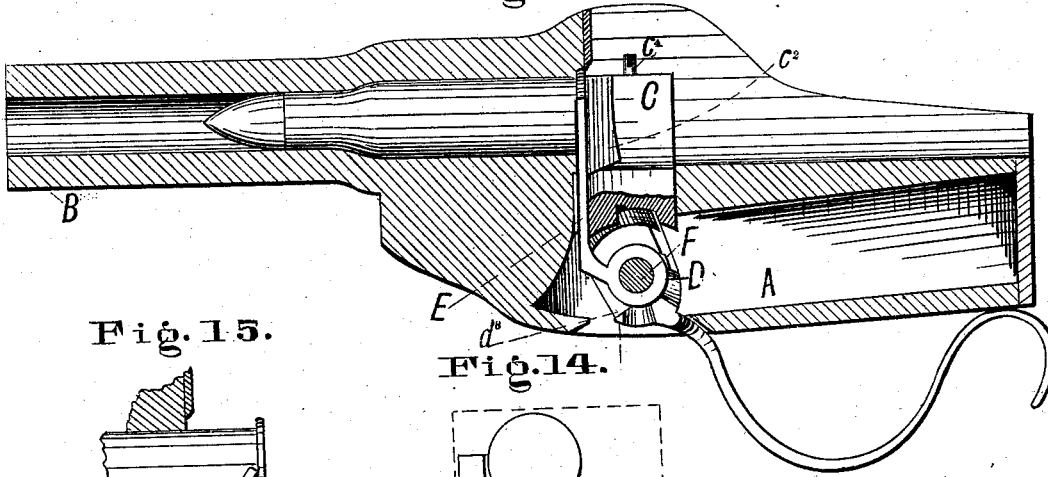

Fig. 15.

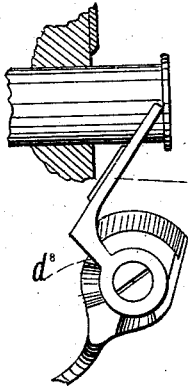

Fig. 14.

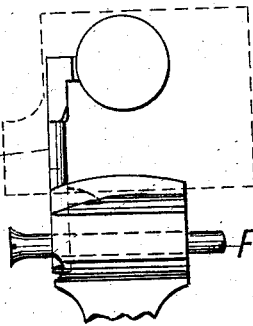

Fig. 13.

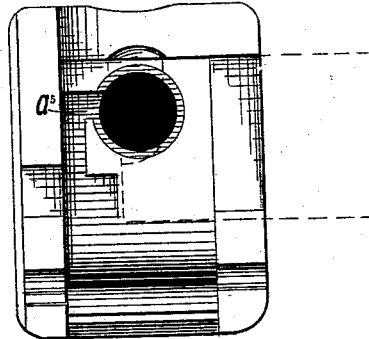

Fig. 16.

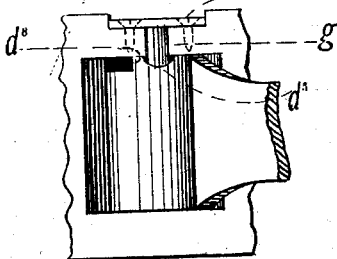

Fig. 17.

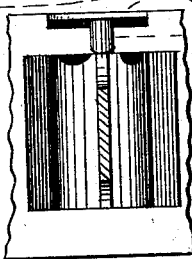
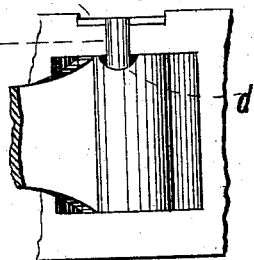

Fig. 18.



WITNESSES:

T. S. West
Cornelius

INVENTOR:
JAMES McALPINE.

BY
H. W. Beadle & Co
ATTYS.

UNITED STATES PATENT OFFICE.

JAMES McALPINE, OF NEW HAVEN, CONNECTICUT.

IMPROVEMENT IN BREECH-LOADING FIRE-ARMS.

Specification forming part of Letters Patent No. 204,675, dated June 11, 1878; application filed January 9, 1878.

To all whom it may concern:

Be it known that I, JAMES McALPINE, of New Haven, county of New Haven, and State of Connecticut, have invented a new Breech for Breech-Loading Fire-Arms; and I hereby declare that the following is a full and exact description of the same, reference being had to the annexed drawings, making a part of this specification.

This invention relates to that class of breech-loading fire-arms which are provided with a laterally-moving breech-block; and it consists, mainly, first, in the means employed to give the breech-block proper movement; and, second, in the combination, with these means, of certain other parts, all of which will be fully described hereinafter.

In the drawings, Figure 1 represents a side elevation of the barrel and the breech or stock to which it is attached, the breech-block, cam-block, cartridge-shell ejector, and locking-spring being removed therefrom; Fig. 2, a plan view of the same; Figs. 3 and 4, views of the cam-block detached; Figs. 5, 6, 7, and 8, views of the breech-block detached; Fig. 9, views of the cartridge-shell ejector detached; Fig. 10, a view of the pivot-pin of the cam-block and the ejector detached; Fig. 11, views of the locking-spring detached; Fig. 12, a longitudinal sectional elevation of the stock and barrel, with the breech-block, cam-block, and cartridge-ejector in their proper positions; Fig. 13, a transverse sectional elevation taken in front of the breech-block, showing the recess in which the ejector lies; Figs. 14 and 15, views of the cam-block and ejector; and Figs. 16, 17, and 18, various views of the cam-block and locking-spring.

To enable others skilled in the art to make and use my invention, I will now proceed to describe fully its construction and manner of operation.

A, Figs. 1, 2, and 12, represents the breech or stock of the fire-arm, which may be constructed generally in any proper manner.

a , Figs. 1 and 2, represents a vertical recess adapted to receive the locking-spring G, Fig. 11.

a^1 , Fig. 1, represents a transverse opening adapted to receive the pivot-pin F, Fig. 10, of the cam-block, and a^2 a recess, in which lies

the stud g , Fig. 11, of the locking-spring G, hereinafter described.

a^3 , Fig. 1, represents a mortise through the breech in a lateral direction, the size and shape of which are indicated by the full and dotted line a^4 , as shown. This mortise also extends through the breech in a vertical direction, as shown in Fig. 2.

a^5 , Fig. 13, represents a recess in the breech adapted to receive the cartridge-ejector shown in Fig. 9.

B, Figs. 1, 2, and 12, represents the barrel, of any proper form, which is secured to the breech-stock in any suitable manner.

C, Figs. 5, 6, 7, 8, and 12, represents the breech-block, consisting of the main portion c , Fig. 5, having an outline of a parallelopiped, the recess c^1 , and inclined face c^2 , Figs. 5 and 12, at one end, and the diagonal groove or recess c^3 , Fig. 6, formed in its lower face, as shown. The surface of the lower face, it will be observed, is curved from edge to edge, as shown in Fig. 7, for the purpose of adapting it to rest properly upon the cam, as shown in Fig. 12.

c^4 , Fig. 12, represents a removable stop-pin, which, when in place, prevents the complete withdrawal of the breech-block from the stock.

D, Figs. 3, 4, and 12, represents the actuating-cam, consisting of a block, d , Figs. 3 and 4, nearly cylindrical in its general outline, which is provided on its longitudinal center line with an opening, d^1 , Fig. 3, on its periphery, with a diagonal flange, d^2 , on one end, with the recess d^3 , Fig. 4, adapted to receive the ring of the ejector, as shown in dotted lines, Fig. 14, and the segmental flange d^4 , having recesses d^5 d^6 , and upon one side with the lever-handle d^7 , as shown.

d^8 , Figs. 12 and 16, represents a shoulder, by means of which the ejector is actuated, as will be hereinafter described.

E, Figs. 9, 12, 14, and 15, represents the ejector or extractor for withdrawing the shell of the cartridge after the latter has been exploded, consisting of the ring e , Fig. 9, and the bent arm e^1 , having the right-angled projections e^2 e^3 , the latter of which is provided with an inclined face, for purposes hereinafter explained.

F, Figs. 10, 12, and 14, represents a pin extending transversely through the opening a^1 of the breech, which serves as a pivot-shaft for the cam-block and cartridge-shell ejector, as shown.

G, Figs. 11, 16, 17, and 18, represents a metal plate adapted to lie in the recess a , Figs. 1 and 2, of the frame, which is secured thereto at one end by means of screws, as shown in dotted lines, Fig. 16, and provided at the other with a right-angled stud or projection, g , as shown.

The independent parts having been constructed in the manner hereinbefore described, the same may be introduced into the breech for the purpose of making the fire-arm complete in the following manner: First, insert the ejector, Fig. 9, into the recess a^5 , Fig. 13, of the breech; then slide the breech-block into the mortise, as indicated in dotted lines, Fig. 13; then insert the cam-block into place through the opening below, and adjust the parts so that the flange d^2 will lie in the groove c^3 , as shown in Fig. 12; then pass the pin F through the openings in the frame, ejector, and cam-block, and screw the locking-spring to place.

When thus united, the operation will be substantially as follows: The fire-arm having been loaded and properly operated to bring its parts into the position shown in Fig. 12, it may be fired in any proper manner to explode the cartridge.

After having been fired, the lever-handle d^7 must be moved downward and forward, by which means the cam-block is actuated to open the breech and throw out the cartridge.

The breech is opened, it will be understood, by the revolution of the cam-block on its axis, by which means its flange is caused to bear against the rear side of the groove of the breech-block and move the latter in a lateral direction, the principle of operation being the same as that found in the well-known worm-screw and rack-bar, the flange of the cam-block forming, in fact, a segment of a worm-screw, and the breech-block a portion of a rack-bar.

The cartridge-shell is ejected, it will be understood, by the contact, at the proper time, of the shoulders d^8 , Fig. 15, of the cam-block with the arm of the ejector, by which means the latter is caused to move in a rearward direction and eject the shell, as shown in Fig. 15, connection being made with the shell by

means of the projection e^3 , which extends into position behind the flange, as shown in Fig. 14.

A fresh cartridge having been inserted in the breech, it will be carried home to its firing position by a reverse movement of the lever, the movement of the cartridge being effected by the contact with the head of the same of the inclined face c^2 of the cartridge-block as the latter moves laterally to place. By this movement of the breech-block, also, the ejector is returned to its normal position, this result being effected by the contact of the end of the block with the inclined face of the projection e^2 , as indicated in dotted lines, Fig. 14.

By means of the locking-spring G the lever d^7 is securely held in either position against accidental movement, this result being accomplished by the projection of its stud either into the recess d^5 or d^6 of the cam-block, as shown in Figs. 16 and 18.

Some of the advantages of the described construction are as follows: The movements of the acting parts are positive, so that failure of operation is impossible. The parts are simple and few in number, so that the construction is not complicated or expensive. The breech-block, being fully supported in the rear, is adapted to resist the strain and absolutely prevent back-fire. The breech is tightly closed when the parts are in firing position, and yet is readily opened when desired for the purpose of ejecting the cartridge-shell and inserting a fresh cartridge.

Having thus described my invention, what I claim as new, and desire to secure by Letters Patent, is—

1. In combination with the lateral-moving breech-block C, the actuating-cam D d^2 , made in one piece, having the lever d^7 , as described, the construction being such that by the movement of the lever the cam-block is actuated to give the breech-block reciprocating movement in either direction, as may be desired, substantially as described.

2. In combination with the breech-block, the actuating cam-block and the ejector, substantially as described.

3. In combination with the cam-block having the recesses, the locking-spring, as described.

JAMES McALPINE.

Witnesses:

A. HAHN ROBERTSON,
S. H. KIRBY.