

W. R. MILLER.  
Manufacture of Boots.

No. 205,288.

Patented June 25, 1878.

Fig. 1.

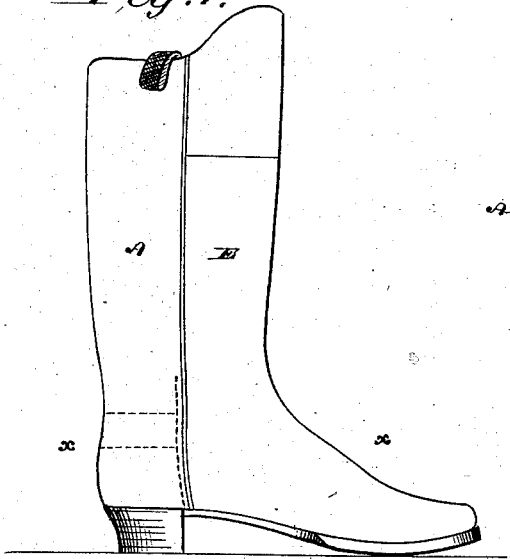

Fig. 2.

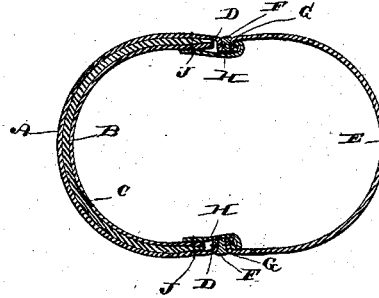

Fig. 3.

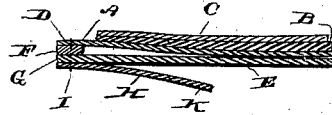

Fig. 5.

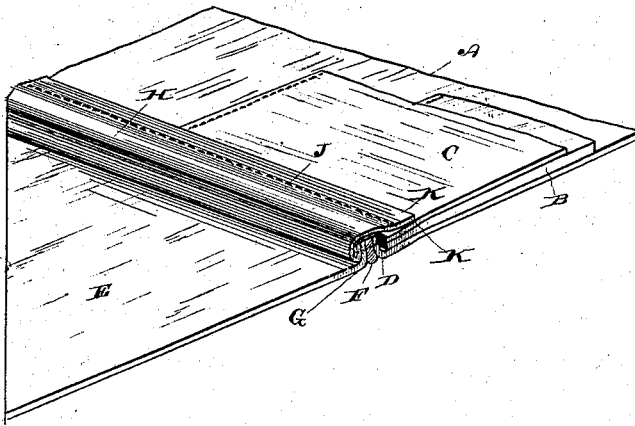

Fig. 6.

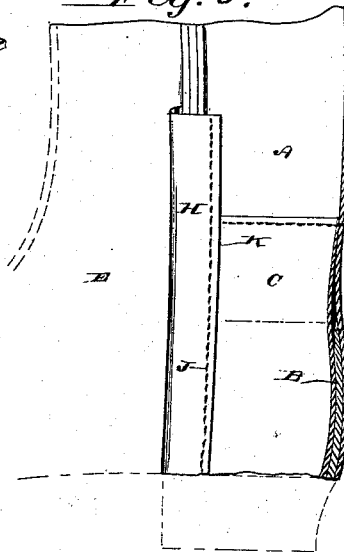

Fig. 4.



Attest:  
H. L. Perrine.  
Albin M. Long.

William B. Miller.  
Inventor.

By A. S. Abbot. Atty.

W. R. MILLER.  
Manufacture of Boots.

No. 205,288.

Patented June 25, 1878.

Fig. 7.

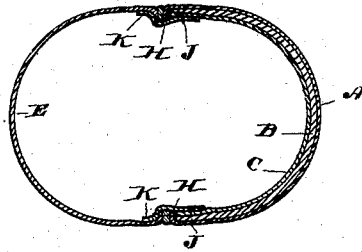

Fig. 8.

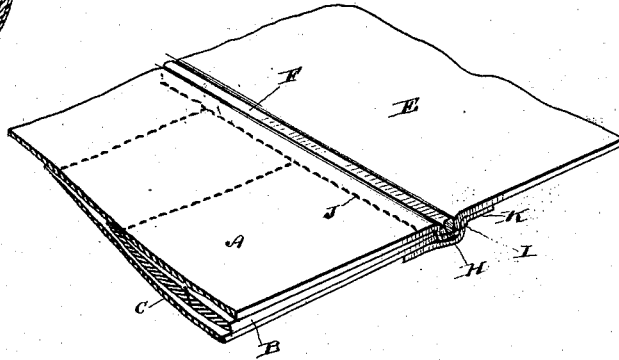

Fig. 9.

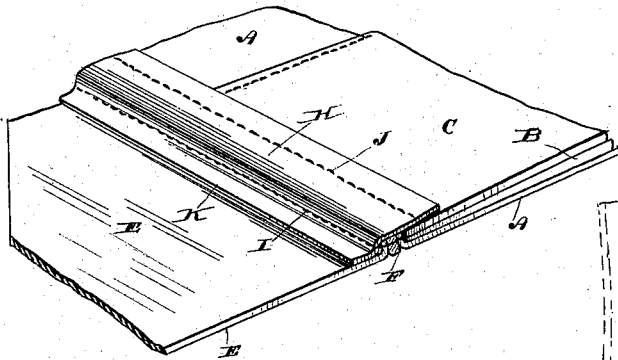
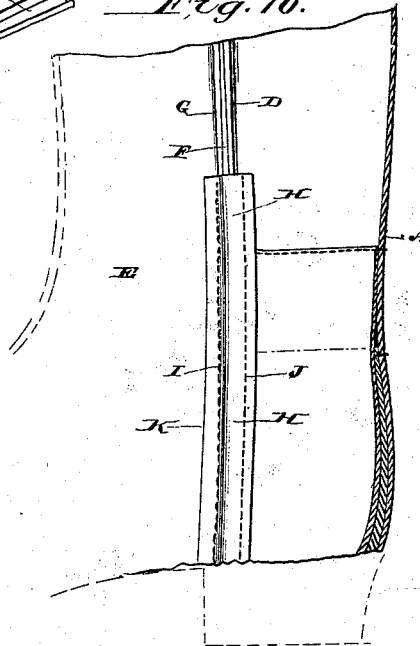

Fig. 10.



Attest:  
H. L. Perrine  
Albin M. Long

William R. Miller.  
Inventor.  
H. J. Abbott.  
Atty.

# UNITED STATES PATENT OFFICE.

WILLIAM R. MILLER, OF BALTIMORE, MARYLAND.

## IMPROVEMENT IN THE MANUFACTURE OF BOOTS.

Specification forming part of Letters Patent No. **205,288**, dated June 25, 1878; application filed June 4, 1878.

*To all whom it may concern:*

Be it known that I, WM. R. MILLER, of Baltimore, in the county of Baltimore and State of Maryland, have invented certain new and useful Improvements in the Manufacture of Boots; and I do hereby declare that the following is a full, clear, and exact description thereof.

This invention relates to certain improvements in the manufacture of boots; and the invention consists in a counter-protector, having its side edges covered by a strip of leather, protecting the side seam, which will be hereinafter more fully set forth.

In order to enable others skilled in the art to which my invention appertains to make and use the same, I will now proceed to describe its construction and arrangement, reference being had to the accompanying drawing, which forms a part of this specification, and in which—

Figure 1 is a side elevation of a boot provided with a counter-protector, having its edges covered by the side-seam protector. Fig. 2 is a section taken on line *xx* of Fig. 1. Fig. 3 is a sectional view, showing the back provided with the counter and protector, the back and front placed together, having a welt interposed between their edges, and a strip of leather arranged under the front, and secured by a row of stitches, forming the side seam. Fig. 4 is a sectional view, showing the back and front extended and the strip of leather turned over the seam, and secured by a row of stitches passing through the back, counter, and its protector. Fig. 5 is an inside view, showing the counter and seam-protector. Fig. 6 is a section through the back, counter, and protector; and Figs. 7, 8, 9, and 10 show modifications of the construction shown in the foregoing figures.

A denotes the back, provided in the usual manner with a counter, B, over which is secured a protector, C, the edges D of the back being left projecting a suitable distance beyond the counter and protector, as shown. The back A is then placed back to back with the front E, as shown in Fig. 3 of drawing, and a

welt, F, interposed between the edge D and the edge G of the parts A and E. A strip of leather, H, is then arranged under the front E, as shown in Fig. 3 of drawing, and secured by a row of stitches, I, passing through the edges D and G of the back and front and the welt F. The two parts are then extended, as shown in Fig. 4 of drawing, and the strip H folded upon itself and over the seam, and secured on top of the counter-protector by a row of stitches, J, adjacent to the side seam, thereby protecting the edge of the counter and its protector.

If desired, the strip H may be secured in forming the side seam near its edge K, and thus obviating the necessity of making the fold as in the foregoing construction.

The former arrangement of the side-seam protector H is preferable in heavy coarse boots, because it adds strength to the seam, and forms a brace or stiffening to support the boot-leg and prevent it from breaking down; but in both cases the side-seam protector laps over the counter-protector, and is secured by a row of stitches adjacent to the side seam, and relieves the side seam of the bulk occasioned by the presence of the counter and protector.

Having thus fully described my invention, what I claim as new, and desire to secure by Letters Patent, is—

1. In a boot, the side-seam protector folded over the side seam, as shown, and united to the counter-protector and upper by a separate seam, substantially as and for the purpose set forth.

2. In a boot, the combination of the counter-stiffening protector with a side-seam protecting-strip, covering the side seam, all arranged substantially as set forth.

In testimony that I claim the foregoing as my own I affix my signature in presence of two witnesses.

WM. R. MILLER.

Witnesses:

H. B. BROWN,  
ALBIN M. LONG.