

H. R. LEONARD.
Machine-Gun.

No. 207,747.

Patented Sept. 3, 1878.

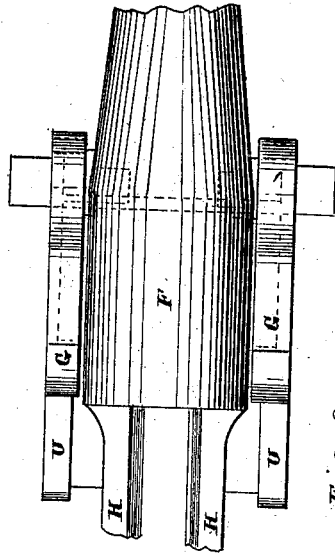

Fig. 1.

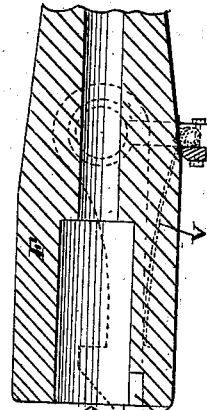

Fig. 2.

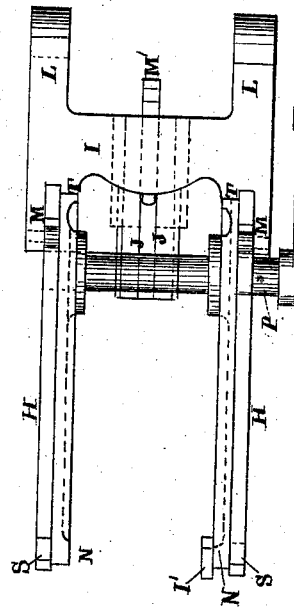

Fig. 3.

Fig. 4.

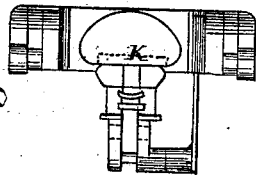
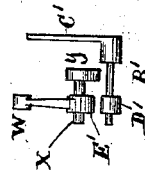

Fig. 5.



Witnesses.

Geo. H. Strong
Chas. Moulthrop

Inventor

Harvey Leonard
By Dewey & Co.
Attys

H. R. LEONARD.
Machine-Gun.

No. 207,747.

Patented Sept. 3, 1878.

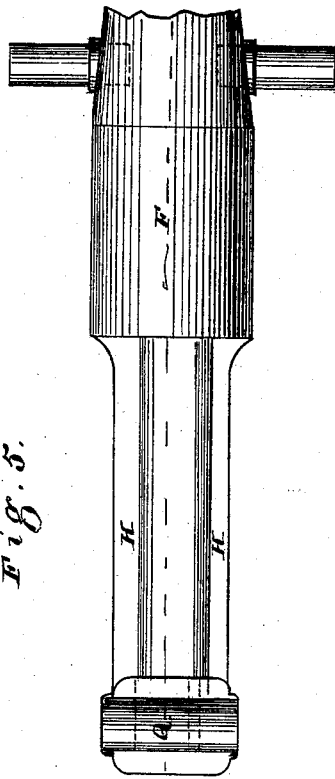

Fig. 5.

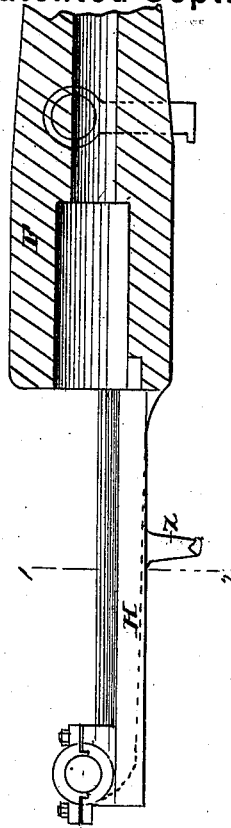

Fig. 8.

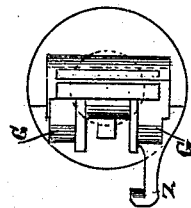

Fig. 6.

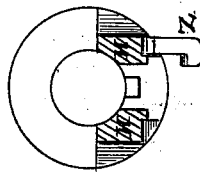

Fig. 7.

Witnesses

Geo. H. Strong
C. W. M. Malthrope

Inventor

Harvey R. Leonard
By Dewey & Co
Attys.

H. R. LEONARD.
Machine-Gun.

No. 207,747.

Patented Sept. 3, 1878.

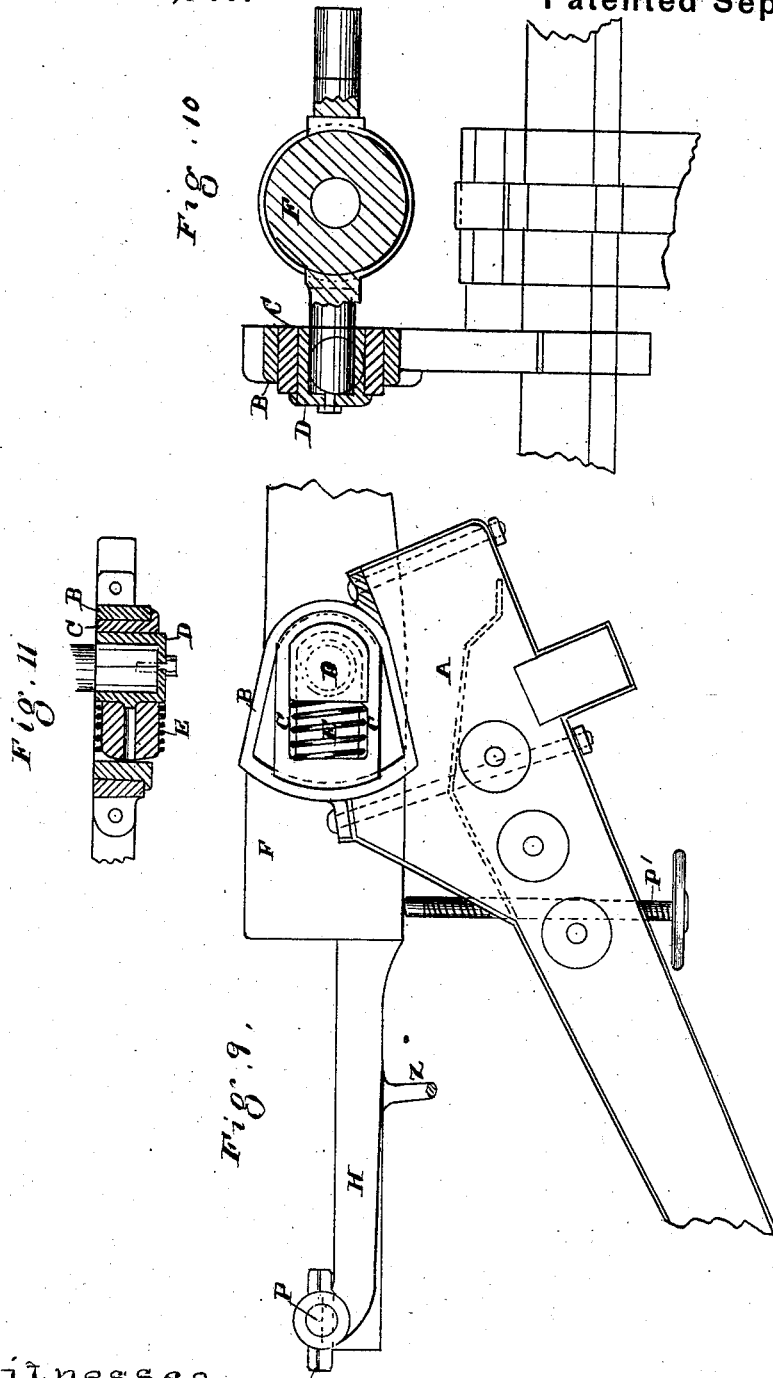

Witnesses
Geo. H. Strong
C. W. Moulthrop

Inventor
Harvey R. Leonard
By *Devey & Co*
attys.

UNITED STATES PATENT OFFICE.

HARVEY R. LEONARD, OF SAN FRANCISCO, CALIFORNIA, ASSIGNOR TO
ABRAHAM ROSENBERG, OF SAME PLACE.

IMPROVEMENT IN MACHINE-GUNS.

Specification forming part of Letters Patent No. 207,747, dated September 3, 1878; application filed
May 7, 1878.

To all whom it may concern:

Be it known that I, HARVEY R. LEONARD, of the city and county of San Francisco, and State of California, have invented an Improved Breech-Loading Gun; and I do hereby declare the following to be a full, clear, and exact description thereof, reference being had to the accompanying drawings.

My invention relates to an improved method of constructing and operating a breech-loading cannon; and it consists in forming an extension on the rear end of the cannon, on which the removable breech slides, the forward-and-back motion being imparted to the breech by cams operated by a crank. Devices are supplied for locking the breech to the cannon at the proper moment, and also for releasing it, so that it may be slid back. I also provide a peculiar arrangement for recoil-springs, whereby the strain is on a direct line with the springs in any position the gun may be. Connected with the breech-piece is a lock, which is self-cocking and discharging. I also provide a removable chamber, in which the cartridges are placed, so arranged as to materially strengthen the gun and to be withdrawn after each discharge by the action of the breech, all as hereinafter described.

Referring to the accompanying drawings, Figure 1 is a plan view of the gun and breech mechanism with a portion of the extension slides cut away. Fig. 2 is a vertical longitudinal section. Figs. 3 and 4 are detail views of the lock and firing devices. Fig. 5 is a plan of the gun with the breech mechanism removed. Fig. 6 is a rear-end view of same. Fig. 7 is a transverse section on line 1 2 of Fig. 8. Fig. 8 is a vertical longitudinal section on line 3 4 of Fig. 5. Fig. 9 is a side elevation, showing the manner of mounting the gun on the carriage. Figs. 10 and 11 are sections through the trunnion-boxes.

Let A represent the gun-carriage, mounted on the usual axle and wheels. On each upper side of the carriage is the trunnion-frame B, made in a peculiar shape, as shown, the trunnion-guide C moving within this frame with a rocking motion. The outer edges or ends of the trunnion-guides C are extended or flanged, as shown, so as to hold them in position within the frame B, and at the same time

admit their having a rocking motion, for the purpose hereinafter described. The central portion of this trunnion-guide C is cut out, so as to admit of the trunnion-boxes D being inserted, and also allow the insertion of the recoil-spring E behind the trunnion-box D and inside of said guide. The box D is held within the guide by means of a tongue and groove formed in the guide and on the box, and also by the outer edges of the box being extended or flanged, as shown. This construction admits of the box D having a forward-and-back motion within the guides, while the recoil-spring E prevents the boxes coming too far back in the guides. The trunnions of the cannon are secured in the slots formed in the boxes D for this purpose in such a manner that they turn with the boxes D, and not independently from them. By this construction the gun may be elevated or depressed, while the recoil-spring is at the same time always on a direct line with the resistance.

On the trunnions, inside the frame and between it and the gun F, are secured the latches G, in such a manner as to swivel about the trunnions. The rear ends of these latches have formed on them projections, which engage with the projections on the removable breech, as hereinafter described.

On the rear lower end of the cannon F is formed the extension H, which is made in two longitudinal parts, as shown, the upper inner edges of these two parts being grooved, as shown. On this extension H slides the removable breech I, the lower portion of the main part of the breech being formed so as to fit on the grooves on the inside edges of the two parts of the extension, and also to rest on the flat portion of the two parts of the extension, as shown.

Attached to or forming part of the removable breech-piece is the lock-case J, which projects downward from the breech-piece between the two parts of the extension H, and slides backward and forward on the extension with the breech-piece. The rear end of this lock-case has a lug, K, formed on it, which slides on the grooves in the upper inside edges of the two parts of the extension H, so as to steady it in position.

The upper sides of the main movable breech-

piece I are extended both ways to the front and rear, as shown. The front extensions, L, have notches or hooks formed on their forward ends to engage with the latches G of the gun at a certain point, as hereinafter described.

The rear extensions, M, of the breech-piece I are so formed as to have a vertical slot or recess at their forward ends, and at their rear ends in the inner side is attached a projecting friction-roller, which engages with the inner side of the flange N on the cams O. The flange N only extends half-way around one face of the eccentrics or cams O, as shown.

A crank-shaft, P, passes across the rear end of the extension H, fitted in a suitable journal-box, Q, which joins the two parts of said extension together at that point. A crank, R, on the end of this shaft rotates the shaft and with it the two cams.

At that point of the cams farthest from the shaft P is a lug, S, formed just clear of the end of the flange N. One of these lugs S on each cam passes on the revolution of the cam down through the vertical slot formed between the shoulder T on the rear end of the breech-piece and the rear extension, M, of the breech-piece. As the cams are revolved and these lugs S pass down through the slots, as shown, they engage with the arms U on the rear ends of the pivoted latches G, and depress the rear ends of said latches, thus disengaging the hooks or gripes on the rear end of said latches from the hooks or gripes on the front extension, L, of the breech-piece I, and allowing the breech-piece to be drawn back by the action of the cam from the gun. Springs V throw the latches G back into position again as soon as the hooks on the latches G and extension L are disengaged, and the lugs S on the cams slide off the arms U as the cam is revolved. The hooks or gripes on the ends of the latches and extensions of breech-piece are beveled off in opposite directions, so that as the breech-piece is moved forward by the action of the cam the beveled edges of the hooks on the extension L slide on the face of the beveled hooks on the latches G, depressing the rear ends of the latches until the hooks are in a position to engage, when the springs V throw the latches up and the hooks engage, thus attaching the breech-piece firmly to the rear end of the gun. The inner faces of these hooks are also beveled, as shown, so that they hold firmly together.

Now, it will be seen that when the gun is fired the breech-piece takes the recoil, of course; but as this is directly connected with the trunnions by means of its forward hooked extensions, L, and the latches G, the breech-piece is held firmly in position. The mechanism is so arranged that at the moment of firing when the breech-piece is in position the cam O has its longest part on a direct line with the gun and extension H, and its edge is in close contact with the shoulders T, thus assisting the breech-piece at the moment of the greatest strain from the recoil. Moreover, the latches

are attached to the trunnions, and as these trunnions are on the boxes, behind which are springs, as herein described, the main strain comes onto the gun-carriage, as in ordinary guns, the springs relieving the strain or recoil.

The lock, by means of which the charge is fired, is constructed in a peculiar manner, and is contained in the lock-case J. In the center of the lock-case, and projecting upward, is the hammer W, which is held in place by the pin X, passing transversely through the sides of the lock-case. This pin X projects through on one side of the case J, and has attached to it the cam Y, which engages with the lug Z on the lower side of the extension H of the gun as the breech is moved back and forth on the extension.

Attached to the lower side of the rear end of the lock-case is the spring A', which presses against the back of the hammer W, and at the proper moment throws it against the needle which discharges the cartridge. Through the lower central portion of the lock-case passes transversely the shaft or pin B', having on one side the lever-arm or trigger C', which extends upward outside of the extension H and between the shoulder T and side of the extension. On this same pin or shaft B', inside and between the two sides of the lock-case, is the sear D', squared on the end or nose, as usual. The lower end of the hammer W is curved forward, as shown, to form a tumbler, E', which has a notch, in which the nose of the sear engages when the hammer is drawn back ready for firing. The sear-spring F' serves to keep the sear up against the tumbler E' in the usual way, so that the point will catch in the notch. A hole or chamber is cut lengthwise through the center of the breech-piece I, in which is the needle G' and spring H'. This hole is enlarged at its rear end, and the rear end of the needle is also enlarged, so as to form a shoulder, to prevent the needle being driven too far forward by the blow of the hammer. The spring H' draws the needle back into position again after the hammer is released from it.

On the end of the cam O farthest from the crank-shaft P, on the inner side, is placed the lug I, which, in the revolution of the cam, strikes against the trigger at the proper moment and presses it forward. As the upper end of the trigger C' is thus pressed forward it draws the sear down, taking its nose out of the notch in the tumbler E', when the main-spring A' throws the upper end of the hammer W against the rear end of the needle G'.

As the breech-piece is drawn back by the revolution of the cams O the small cam V comes in contact with the lug Z. As the cam is raised by the lug, it being fastened on the same pin X as the trigger and tumbler, said cam raises the tumbler, throws the hammer back, and allows the spring S to throw the sear-point into the notch of the tumbler, thus setting the lock ready for discharging the piece.

In order to make this gun more effective and quick-working, I provide a peculiar removable hollow cartridge-chamber, J', having a groove, K', formed around it, near the rear end, and the needle-hole L' formed through its rear end, as shown. The bore of the gun is enlarged at its rear end, as shown, in order that this removable chamber may be inserted.

On the forward central lower end of the removable breech-piece is placed the projecting pin or catch M', having its end turned at right angles upward, to form a catch or hook, which will fit in the groove K' in the removable chamber J'. A slot, N', in the lower rear end of the enlarged part of the chamber of the gun allows this catch M' to enter with the cartridge at the time the breech-piece is against the gun.

The cartridge O' is placed in the removable chamber, and the chamber is laid in the grooves formed on the inner upper sides of the two parts of the extension H. When in this position the hook formed on the pin or catch M' engages with the groove formed around the rear end of the cartridge-chamber, and holds the cartridge close against the front end of the removable breech. As the cams are revolved and the breech-piece is pushed forward, it in turn slides the removable chamber, containing the cartridge, into the gun. After the discharge of the piece, when the breech-piece is drawn back, the catch M, being still engaged with the groove on the removable chamber, draws said chamber back in the grooves, and it can be lifted out and replaced with a loaded one, or a new cartridge may be placed in it.

The usual elevating-screw P' is attached to the carriage to elevate or depress the piece.

The operation of my improved gun is as follows: The removable breech being in its position against the end of the gun, it is necessary to draw it back so as to insert the cartridge. By turning the crank P the cams are revolved, and the lugs S engage with the arms U on the rear ends of the latches G, thus depressing the latches, so as to disengage them from the hooked forward extension, L, of the breech-piece I. At the same time the flanges N on the cams O engage with the projecting friction-rollers on the inner sides of the rear extensions of the breech-piece, thus drawing the breech-piece back.

As the cams are revolved and the breech-piece slides back the small cam Y on the pin X engages with the lug Z and throws the hammer back, thus allowing the sear D' to engage with the notch in the tumbler E', and setting the lock. The action of the flanges on the cams is such as to draw back the breech by means of the friction-rollers until the breech is at the rear end of the extension H. The cartridge-chamber is placed in the guides formed by the upper inner grooved edges of the two parts of the extension H, the catch M' engaging with the groove K' in the cartridge-chamber J'.

Then as the cams are revolved their form is such that the edges of that part on which no flange is formed comes in contact with the shoulders T on the breech-piece, and thus gradually slides the breech-piece forward, it in turn pushing the cartridge-chamber and cartridges before it.

As the breech-piece comes nearly to the gun the forward hooked extensions, L, begin to depress the rear ends of the latches by means of the beveled edges, and just as the breech-piece comes close against the gun the springs V throw the latches up, so that they engage solidly with the hooked extensions L of the breech-piece, and thus keep it close and solid against the gun.

As the cam is revolved a slight distance farther the lug I' engages with the upper end of the trigger C', which depresses the sear and releases the tumbler, when the mainspring A' throws the hammer W against the rear end of the needle G', said needle being impelled forward, so that its point passes through the hole L' in the chamber, where it discharges the cartridge in the usual way.

By the use of the removable chamber herein described, guns may be very rapidly loaded and fired without heating the gun. A number of removable chambers may be used for each gun, so that a cold one may be substituted as often as necessary. With these chambers there is no danger of the gun's being weakened by rapid firing, and as the chambers are of steel they take the strain of the discharge from the gun itself.

The mechanism for loading and firing, as herein described, is very simple and effective, and capable of very rapid movement, so that the gun may be fired as fast as cartridges can be introduced to the removable chambers, or the chambers removed and replaced with loaded ones.

Having thus described my invention, what I claim as new, and desire to secure by Letters Patent, is—

1. The gun-carriage A, with its trunnion-frame B, guides C, boxes D, supporting the trunnion of the gun, and the recoil-springs E, the whole combined to operate substantially as and for the purpose herein described.
2. The breech-block I, moving to and from the gun upon the guides H to close and open the breech, and provided with the rear extensions, M, in combination with the flanged rotating cams O, by which the breech is operated, substantially as herein described.
3. The latches G, having the projecting arms U, in combination with the cams or eccentrics O, with their lugs or projections S, by which the latches are disengaged from the breech-block, substantially as herein described.
4. The latches G, operating as shown, in combination with the disengaging-lugs S upon the cams and returning-springs V, substantially as and for the purpose described.
5. The combination of the gun F, with its extension H, the cams O, with their shaft P,

and the breech-block I, with its shoulders T and hooked extension L, mounted upon the trunnions, having elastic supports, as shown, and the latches G, the whole united so as to receive and distribute the recoil, substantially as herein described.

6. The hammer W, tumbler D', and cam Y, mounted upon the shaft X, in combination with the trigger C' and sear D', mounted upon the shaft B', and the lug Z, operating as shown, and the discharging-lug I' upon the cam O, substantially as herein described.

7. The gun F, with its extension breech-block and operating mechanism, all mounted upon yielding trunnions, so as to be allowed to recoil in unison and independent of the carriage and elevating-screw, substantially as herein described.

In witness whereof I have hereunto set my hand.

HARVEY REID LEONARD.

Witnesses:

C. W. MOULTHROP,
FRANK A. BROOKS.